

RAYMOND

Maintenance Manual

**High-Level Orderpicker Lift Truck
with *The ACR System*™**



Models
5400, 5500, 5600

Serial Numbers
00100 and Up

1031794A

Issued: 1/27/06

1031794B

Re-Issued: 7/14/06

This publication, 1031794B, applies to High-Level Orderpicker Models 5400, 5500, 5600, S/N 00100 and up, and to all subsequent releases of this product until otherwise indicated in new editions or bulletins. Changes occur periodically to the information in this publication.

If you need assistance with your lift truck, or to order additional copies of this manual, contact your local authorized Raymond dealer.

To locate your local authorized Raymond dealer, go to www.raymondcorp.com.

©2006 The Raymond Corporation.

The following terms are trademarks of The Raymond Corporation: *The ACR System*, *intellidrive*, *Raymond*. All other brand and product names are trademarks or registered trademarks of their respective companies.

Table of Contents

How to Use This Manual	1-1
Map of the Manual	1-2
Safety	2-1
Definitions	2-2
General Safety	2-3
Battery Safety	2-5
Electrostatic Discharge Precautions	2-7
Jacking	2-8
Tie-Down for Transport	2-10
Towing	2-11
Welding Safety	2-12
Systems Overview	3-1
General System Data	3-2
Lift Truck Specifications	3-4
Installation	3-5
Modes of Operation	3-7
FlashWare Program	3-26
Wire Guidance	3-35
Cold Storage	3-36
Configuration Codes	3-37
Storage	3-38
Special Tools	3-38
Scheduled Maintenance	4-1
Maintenance Guidelines	4-2
<i>Maintenance Minder</i> [™] Tool	4-3
Initial 90 Day/250 Deadman Hours (HD) Maintenance	4-5
Every 180 Days or 500 Deadman Hours (HD)	4-6
Every 360 Days or 2000 Deadman Hours (HD)	4-9
Chain Maintenance	4-10
Troubleshooting	5-1
Electrical Troubleshooting	5-2
Drive Unit Troubleshooting	5-21
Troubleshooting Procedure	5-23
Messages, Codes and Tests	6-1
Operator Display Messages	6-2
Messages and Codes	6-9
Analog Input Tests	6-31
Input Tests	6-55
Output Tests	6-91
Component Procedures	7-1
Component Locator Photos	7-3
Steering and Controls	7-9
Steer Motor/Gearbox	7-10
Home Proximity Sensor Adjustment	7-11
Control Handle	7-12
Deadman Pedal	7-18
Emergency Power Off Switch	7-20
Drive and Brake	7-21
Drive Motor	7-22

Drive Unit - Standard	7-23
Drive Unit - Heavy Duty	7-42
Brake	7-54
Drive Wheel	7-58
Electrical Components	7-61
Battery Procedures	7-62
Motors	7-64
AC Motor Service	7-68
Power Amplifiers	7-71
Carriage Control Card Replacement	7-72
EPROM/Microprocessor Removal/Replacement	7-73
Hydraulic Components	7-75
Flow Sensor Service Notes	7-76
High Pressure Relief Valve Adjustment	7-79
Lift/Lower and Load Holding Valves	7-80
Bleeding Lift Cylinders	7-81
Lift Pump and Motor	7-82
Pressure Switch Adjustment	7-83
Side Lift Cylinder	7-84
Center Lift Cylinder	7-88
Mast Section	7-91
Carriage	7-92
Center Cylinder Ride Spring Chain Anchors	7-94
Forks	7-95
Mast Bearing Shimming	7-96
Upper Mast Bearing Replacement	7-97
Theory of Operation	8-1
System Architecture	8-2
Traction System	8-6
Steering System	8-8
Lift/Lower System	8-10
Wire Guidance System	8-13
Pin-Out Matrix	8-19
Appendix	A-1
Lubrication Specification Chart	A-2
Thread Adhesives, Sealants, and Lubricants	A-3
Component Specific Torque/Information Chart	A-4
Torque Chart - Standard (Ferrous)	A-5
Torque Chart - Metric	A-6
Torque Chart - Standard (Brass)	A-7
Decimal Equivalent Chart	A-8
Standard/Metric Conversions	A-10
Schematics	A-11
Index	I-1

Page Revision Record

This section is a record of all revised pages in this manual. Whenever a page is revised, this section is updated and included in the revision package.

Pages are revised due to technical and non-technical changes described as follows:

- Technical changes – These changes are identified by a vertical line (change bar) in the left margin next to the change. Pages affected by technical changes are identified with the revision date in the footer. These pages are also available on the Raymond iNet.
- Non-technical changes – These changes consist of typographical and grammatical corrections, paragraph renumbering, repagination, and so on. Non-technical changes are not identified with a change bar, however, affected pages are identified with the revision date in the footer.

Original Issue Date: 1/27/06

Revision Date: Re-Issued: 7/14/06

RAYMOND

Section 1. How to Use This Manual

Map of the Manual

Map of the Manual

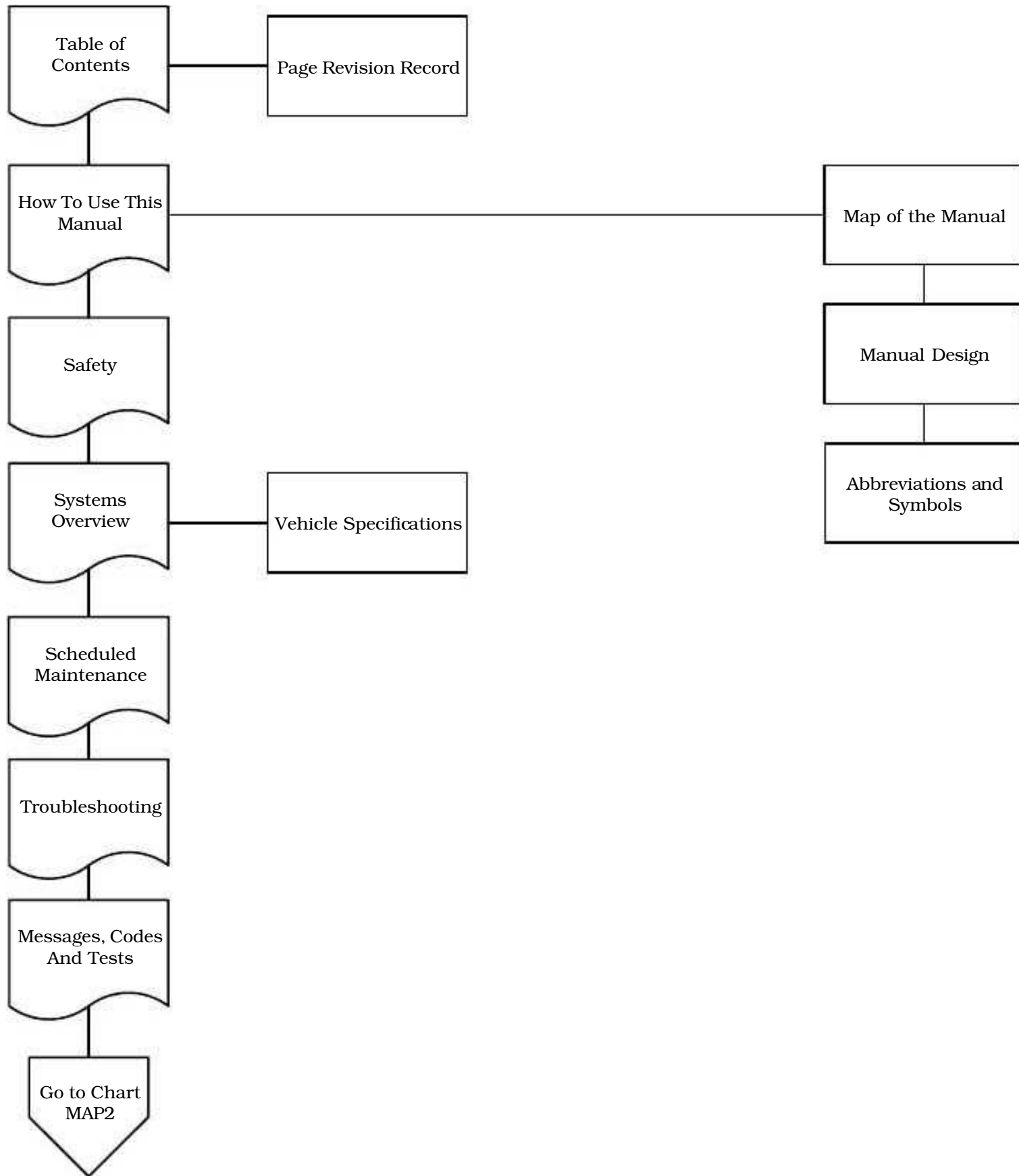

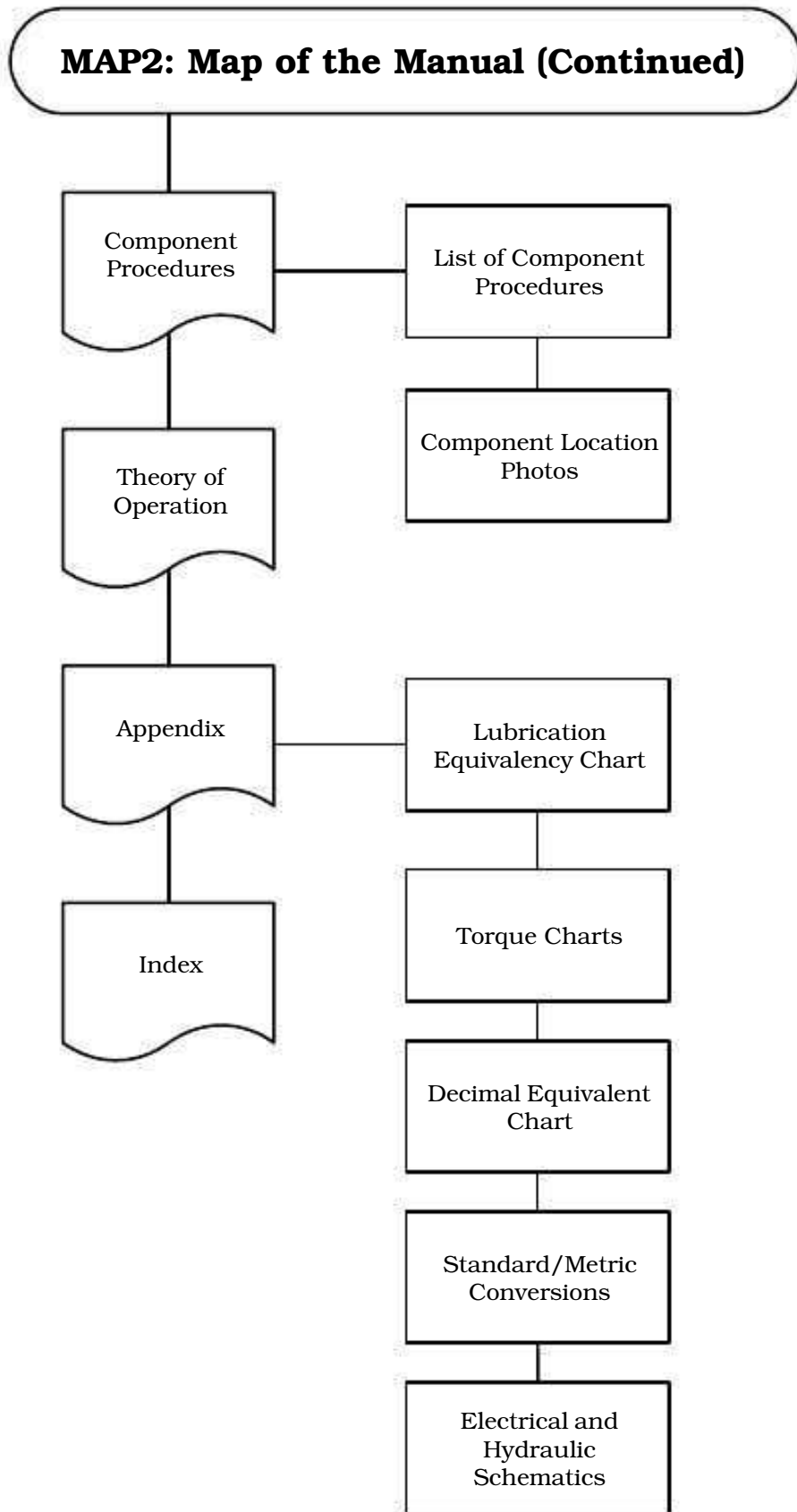

Manual Design

Manual Design

This manual is designed with the following objectives in mind:

- provide technical coverage for expected levels of user expertise
- anticipate your needs and reduce your decisions regarding maintenance
- reduce page flipping through a “one-stop shopping” approach

The two-line running page header at the top of each page tells you:

- Name of the manual
(Model 5400, 5500, and 5600 Maintenance Manual)
- Current Section Title
(for example, this page; Section 1. How to Use This Manual)
- Current topic
(for example, this page; Manual Design)

This manual consists of the following sections:

- **How to Use This Manual** explains the manual format and design as well as abbreviations and symbols used.
- **Safety** explains warning and caution notes, general safety rules, and safety rules for batteries, static, jacking, and welding.
- **Systems Overview** includes general lift truck overview, programming instructions, and configuration menu.
- **Scheduled Maintenance** outlines the recommended schedule of preventive services to keep your lift truck working most efficiently.
- **Troubleshooting** is designed to take you from a symptom to a specific sequence of tests in order to isolate a failing component.
- **Messages, Codes and Tests** lists the electrical fault codes and procedures for running firmware electrical tests.

- **Component Procedures** gives step-by-step procedures for testing, removal, installation, and adjustment of individual truck components. Components are grouped by truck system.

To find a component procedure, you may use one of three methods:

- Look up the component name in the **List of Component Procedures**.
- Find the component in the **Component Locator Photos**.
- Look up the component name in the maintenance manual **Index**.
- **Theory of Operation** explains signal flow within the electrical and hydraulic systems for various conditions of lift truck operation. This section also contains a detailed connection point table (Pin-Out Matrix) designed to assist in testing and troubleshooting the truck.
- **Appendix** contains reference information such as torque values, lubricants, standard/metric conversions, and system schematics.
- **Index** lists subjects alphabetically.

Abbreviations and Symbols

The following abbreviations, acronyms and symbols are used in this manual.

Term/Symbol	Definition	Term/Symbol	Definition
A	Ampere	FF	Forks-first
AC	Alternating Current	fpm	feet per minute
Agnd	analog ground	FRC	Fuse/Relay Card
amp	Ampere or amplifier	ft.	foot or feet
approx	approximately		
Assy	assembly	gal.	gallon or gallons
aux	auxiliary	GM	Guidance Manager
AWG	American Wire Gauge	gm	gram
		Gnd	ground
BSOC	Battery State-of-Charge		
BWI	brush wear indicator	HD	hours on deadman
		Ht	height
CAN	Controller Area Network	Hgt/Wgt	Height/Weight
CCC	Carriage Control Card	Hz	Hertz
CCW	counterclockwise		
CFP	Contacto Fuse Panel	in.	inch or inches
cm	centimeter		
COP	Computer Operating Program	kg	kilogram(s)
		kHz	kilohertz
CW	clockwise	km/h	kilometers per hour
CS	cold storage	kPa	kilo Pascal
DC	Direct Current	lb.	pound or pounds
Dgnd	digital ground	LED	Light Emitting Diode
DMM	Digital Multi Meter	L/H	Load Holding
DVM	Digital Voltmeter	L/L	Lift/Lower
		LPA	Lift Power Amplifier
EE	UL Electric Truck Type Certification Rating where electrical equipment is completely enclosed	LPC	Lift Power Contactor
		mA	milliampere
EMF	ElectroMotive Force	max	maximum
EOA	End-of-Aisle	min	minute or minimum
EPO	Emergency Power Off	mm	millimeter
EPROM	Erasable Programmable Read Only Memory	MM	<i>Maintenance Minder</i> [™]
		mph	miles per hour
ESD	Electrostatic Discharge		
ESDS	Electrostatic Discharge Sensitive		

Abbreviations and Symbols

Term/Symbol	Definition	Term/Symbol	Definition
mS	millisecond or milliseconds	V	Volt or Volts
mV	millivolt or millivolts	VDC	Volts Direct Current
mVAC	millivolts - alternating current	VM	Vehicle Manager
No.	number	wrt	with respect to
NV	non-volatile	Wt	Weight
NVM	Non-Volatile Memory	w/	with
N•m	newton meter	w/o	without
OACH	Overall Collapsed Height	@	at
OD	Operator Display	™	trademark
OI	Operator Interface	©	copyright
OSHA	Occupational Safety and Health Association	+	plus or positive
oz.	ounce	-	minus or negative
prox	proximity	±	plus or minus
pot	potentiometer	°	degrees
psi	pounds per square inch	°F	degrees Fahrenheit
PWM	Pulse Width Modulation	°C	degrees Celsius
P/N	Part Number	<	less than
RAM	Random Access Memory	>	greater than
rpm	Revolutions per Minute	%	percent
SAE	Society of Automotive Engineers	=	equals
sec.	second		
SG	specific gravity		
SOL	Solenoid		
spec	specification		
temp	Temperature		
TF	Tractor-first		
TPA	Traction Power Amplifier		
TPC	Traction Power Contactor		
TS	Traction Speed		
T/S	troubleshoot		
UL	Underwriters Laboratories, Inc.		

Section 2. Safety

Definitions

Definitions

Throughout this manual, you will see two kinds of safety reminders:

 **WARNING**

A Warning indicates a potentially hazardous situation that, if not avoided, could result in serious bodily injury or death.

 **CAUTION**

A Caution indicates a potentially hazardous situation that, if not avoided, could result in minor or moderate bodily injury or damage to the lift truck or nearby objects. It also can be used to alert personnel against unsafe practices.

General Safety



Do *not* operate or work on this truck unless you are trained, qualified and authorized to do so, and you have read both the Owner Manual and the Operator Manual.



Know the truck's controls and what they do.



Do *not* operate this truck if it needs repair or if it is in any way unsafe.

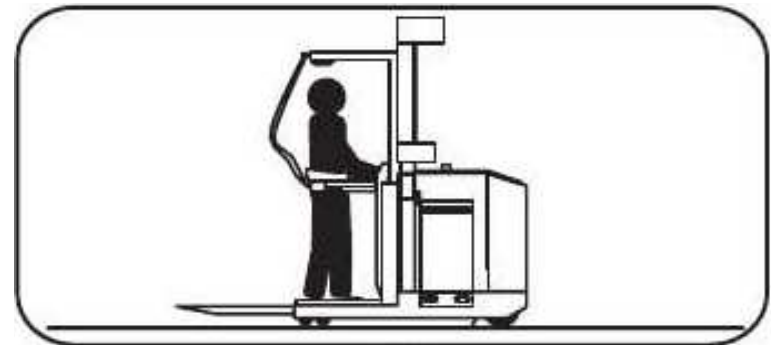

Operate this truck only from the operator position. When elevated, make sure you wear a safety belt attached to a secured tether.

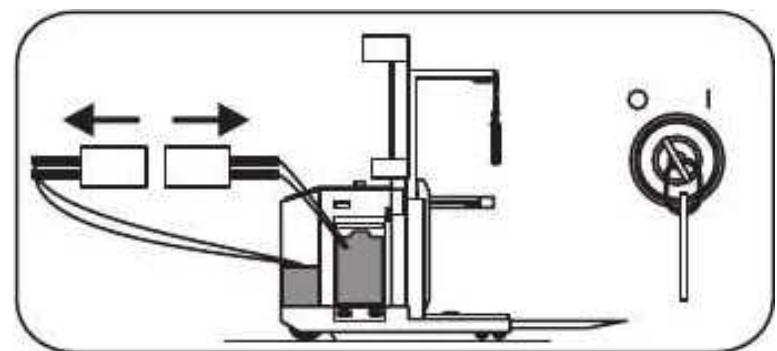

Before working on this truck, always turn the key switch OFF and disconnect the truck's battery connector (unless this manual tells you otherwise).

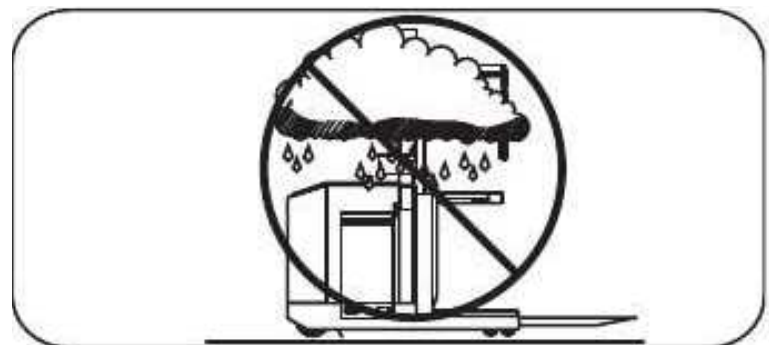

Always use and park this truck indoors.

Do *not* park a truck in a cold storage area overnight unless the truck is conditioned for cold storage.

Tractor

The tractor holds the majority of electrical and hydraulic components of the lift truck, including the battery, power section, pumps, and motors. For the location of specific components, see Component Locator Photos on page 7-3.



Figure 3-2. View Inside Tractor Compartment

3

Lift Truck Specifications

Lift Truck Specifications

Specification Plate

This lift truck is rated for performance by load center and load weight. Review the specification plate for detailed load capacity and load center information. See Figure 3-3.

Due to continuous product improvement, specifications are subject to change without notice or obligation.

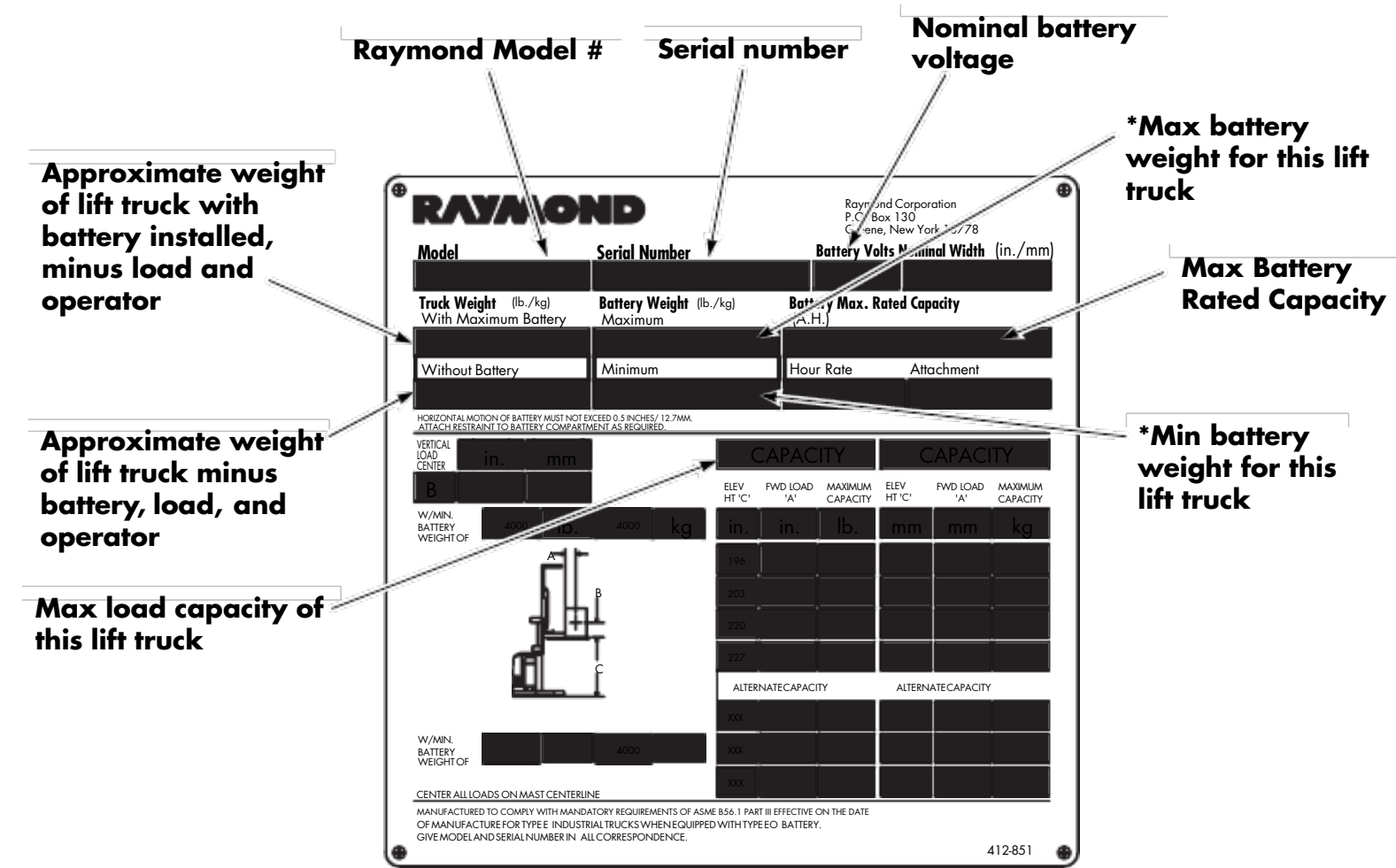

***Battery weight must be between the min and max weight.**

Figure 3-3. Lift Truck Specification Plate

3412-645.wmf

Installation

Installation procedures must be performed by a Raymond Certified Dealer Technician to ensure warranty coverage.

During installation, a visual and functional inspection must be performed.

Installation Procedure

NOTE: Two technicians are required for the installation/assembly of this truck.

WARNING

Place the mast, tractor, and pallets in an open area where it is safe to work.

- **The truck components are heavy, unstable, and difficult to handle. Use caution when lifting and assembling this truck.**
- **Personnel involved in the installation and assembly of this truck should wear gloves, safety glasses, steel toe boots, and a safety helmet.**
- **Do NOT remove the banding that secures the operator platform to the baselegs until the truck is upright.**

Uprighting a Cradled Vehicle

Two Hoist Method

This procedure requires two chain hoists of suitable weight capacity.

1. Position the cradled truck directly beneath and parallel to the chain hoist rail.
2. Attach one hoist to the upper crosstie of the mast.

NOTE: Place blocks between the crossties to avoid bending them.

3. Attach the second hoist to the baselegs.
4. Slowly raise each hoist until there is no slack in the chains.

CAUTION

While performing step 5, make sure the hoist attached to the baselegs does not lift the cradle off the floor. Also, do not let the chain become slack as this will allow the truck to drop.

5. Continue to slowly lift the hoist attached to the mast until the center of gravity shifts, causing the weight of the truck to shift to the hoist attached to the baselegs.
6. Lower the truck with the hoist attached to the baselegs until it is standing upright on the floor.
7. Remove the chain from the baselegs.
8. Remove the chain from the upper crosstie of the mast and attach it to the upper cross-piece of the cradle.
9. Loosen and remove the nuts holding the wooden cradle cross-piece to the mast, then remove the wooden cross-piece.
10. Remove the bolts from the bottom cradle cross-piece attached to the truck's front bumper.
11. Lift the cradle up and away from the truck and lower it to the floor.
12. Carefully remove the strapping securing the operator platform to the baselegs.
13. Remove the shipping cap and screws on top of the hydraulic fluid reservoir. Install the breather cap and screen.
14. Check the fluid level of the hydraulic reservoir.
15. Remove the plug from the drive unit and install the dipstick.

Hoist and Lift Truck Method

This procedure requires a lift truck and a chain hoist of suitable weight capacity.

NOTE: Use this procedure when only one chain hoist is available.

1. Position the cradled truck directly beneath and parallel to the chain hoist rail.
2. Position the forks of the lift truck under the upper cross-piece of the cradle.

Cold Storage Conditioning

3. Attach the chain hoist to the baselegs of the truck.
4. Slowly raise the hoist until there is no slack in the chain.

CAUTION

While performing this procedure, make sure the hoist attached to the baselegs does not lift the cradle off the floor. Also, do not let the chain become slack as this will allow the truck to drop.

5. Raise the upper end of the cradle with the forks of the lift truck.
6. Continue to slowly lift the cradle until the center of gravity shifts, causing the weight of the truck to shift to the hoist.
7. Lower the truck with the hoist until it is standing upright on the floor.
8. Remove the chain from the baselegs and attach it to the upper cross-piece of the cradle.
9. Loosen and remove the nuts holding the wooden cradle cross-piece to the mast, then remove the wooden cross-piece.
10. Remove the bolts from the bottom cradle cross-piece attached to the truck's front bumper.
11. Lift the cradle up and away from the truck and lower it to the floor.
12. Carefully remove the strapping securing the operator platform to the baselegs.
13. Remove the shipping cap and screws on top of the hydraulic fluid reservoir. Install the breather cap and screen.
14. Check the fluid level of the hydraulic reservoir.
15. Remove the plug from the drive unit and install the dip stick.

Functional Inspection

Before a truck can be put into service, a Raymond Installation Report *must* be completed.

Vehicle Operation

Refer to the Owner and Operator Manuals for truck function information.

Warranty

The Installation Report activates the Raymond warranty on the truck. Failure to correctly complete the Installation Report can void the warranty on the truck.

Password/Superword Changes

Upon completion of truck installation, change the Password and Superword to the customer's specifications. See Changing Password or SuperWord on page 3-12.

Cold Storage Conditioning

If the truck is to be used in a Cold Storage (CS) application, it is equipped with CS option components when delivered from the factory. However, the fluid in the hydraulic reservoir *must* be changed.

Make sure the truck is in a clean area, away from any possible contaminating elements that could enter the hydraulic system.

1. Drain the hydraulic reservoir completely. Also drain fluid from the hydraulic lines and cylinders.

CAUTION

Use of the wrong hydraulic fluid for a specific application can cause damage to hydraulic system components. Warranty claims will not be paid on component damage resulting from incorrect fluid use.

2. Fill the hydraulic reservoir with the correct fluid. See Lubrication Specification Chart on page A-2.
3. Operate all truck functions and check for hydraulic leaks.
4. Bleed the entire hydraulic system before placing the truck into service.
5. Check reservoir fluid level.

Modes of Operation

This vehicle can operate in one of two modes of operation:

- Run Mode
- Program Mode

Run Mode

Run Mode is the normal operating mode for the vehicle. Run Mode is the only mode that normal vehicle travel is allowed. In this mode, the selectable display is shown on the Operator Display (OD). Run Mode will start automatically when Program Mode is exited or after SelfTest has passed.

Audible Alarm Description

Within Run Mode, various truck situations are identified using different audible tones and patterns. The following are the tones/patterns and possible cause for different operating conditions.

Run Mode Tones

Tone 1. A single tone that indicates:

- UP/DOWN (▲▼) buttons or ENTER (↵) is depressed
- Maximum steer request is reached

Tone 2. Two tones (high/low) that indicate the TPC and LPC contactors are disabled (opened). Travel, steering, and lift/lower are disabled and the brake is applied until the problem is corrected.

Tone 3. Three tones (high/medium/low) that indicate:

- A travel performance limitation
A travel performance limitation will only allow the truck to travel at a maximum of 1 mph (1.6 km/h). Lift, lower, steering, and horn functions will operate normally.
- A traction system shutdown
A traction system shutdown will not allow the truck to travel. Lift, lower, steering, and horn functions will operate normally.
- A shutdown in the lift system

If a problem occurs in the lift system, lift is prevented. Travel, lower, horn, and steering functions will still be permitted.

Tone 4. A continuous tone with deadman pedal pressed and Auto/Manual switch in Manual indicates the truck is over the guide wire.

Tone 5. Tone ramps up then repeats indicates the truck is seeking and aligning over the guide wire. The tone will continue until the truck is locked on the guide wire or the Auto/Manual switch is changed to Manual.

Tone 6. Descending tone (bomb drop) that indicates an incorrect Password or Electronic Passkey was entered.

The tones described will not repeat continuously. A fault code and associated message will scroll across the Operator's Display. The message will repeat continuously until the key switch is turned OFF.

Password Levels

Two password levels are used with this system:

- Password
- SuperWord

Password

Password allows access to Configure Mode only. Instructions for using **Config** are outlined on page 3-12.

SuperWord

SuperWord allows access to all program levels available. Only qualified service technicians should have access to SuperWord.

Instructions for entering or changing Password or SuperWord are described on page 3-8.

NOTE: It is *strongly* recommended that the SuperWord be changed from the factory default to something else during installation so access to programming is limited to qualified personnel. With that in mind, it is very important to remember the unique SuperWord code that was entered and saved. If the code is lost or forgotten, it is necessary for a technician to reset the truck to factory

Program Mode

default settings. This would require the reconfiguration of all variable settings (Speed, Acceleration, Password, SuperWord, and so on).

Program Mode

Program Mode is divided into three categories:

- Configure (**Config**)
- Learn (**Learn**)
- Maintenance (**Maint**) - Static or Active

Configure Mode

The Configure Mode (**Config**) is used to adjust the vehicle's performance to specific customer requirements. To access **Config**, Password or SuperWord must be used. For a detailed description of Configure Mode, refer to page 3-12.

Learn Mode

The Learn Mode is used to calibrate:

- Throttle potentiometer (VR1) (Controls)
- Lift/lower potentiometer (VR2) (Controls)
- *intellispeed*[™] sensor - height (optional)
- Pressure transducer - weight (optional)
- Wire guidance frequency and offset (optional)

A discussion of the Learn process for these items is included in this section.

NOTE: To access **Learn**, SuperWord must be used.

Maintenance Mode

The Maintenance Mode (**Maint**) is used to verify the operation of various circuits of the truck. In Maintenance Mode, individual circuits can be energized and cycled to aid in troubleshooting. Some tests can be performed under both active and static conditions to further aid in problem diagnosis.

Static Maintenance Mode

This mode allows one function at a time to be tested.

Active Maintenance Mode

This mode allows all input and analog tests to be active in Run Mode. Navigate through the OD using the Up/Down (**▲▼**) buttons, then enter Analog or Input by pressing the Enter (**↵**) button. You can now scroll through all input and output tests. There is no need to select items for Active Maintenance, and you are not limited to the number of items, they are all available. To return to the OD, navigate to **Quit** and press Enter (**↵**).

To access **Maint**, SuperWord must be used. For a detailed description of Maintenance Mode, refer to page 3-24.

Entering Program Mode

Program Mode can be entered by one of the following two methods.

Method 1

1. With key switch OFF, hold the horn button in and move the lift/lower control to full lift.
2. Turn the key switch to the ON position.
3. The OD will show all eight segments with a solid bar in each segment. See Figure 3-4.

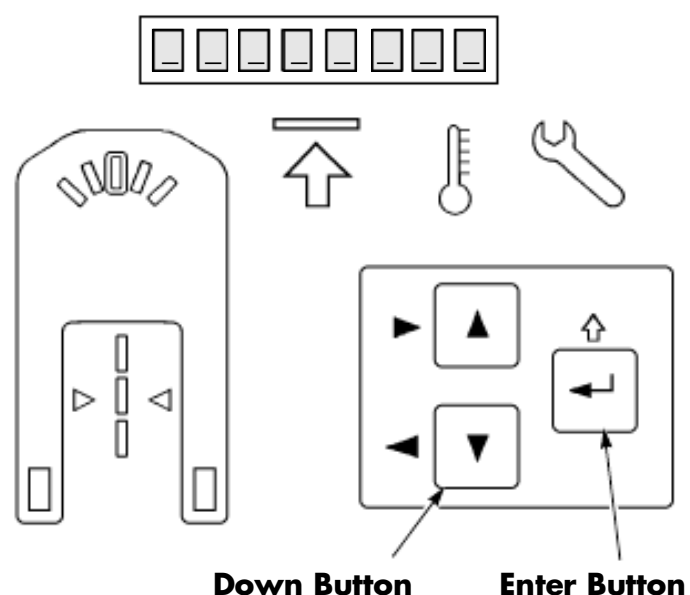

Figure 3-4. Operator Keypad and Display

Entering Program Mode

Method 2

1. With the key switch OFF, press and hold the Enter (↵) button and Down (▼) button at the same time. See Figure 3-4.
2. Turn the key switch to the ON position.
3. The OD will show all eight segments with a solid bar in each segment.

Entering Password or SuperWord

Refer to Figure 3-5.

1. Observe the OD. The flashing bar at the bottom of the left-most segment indicates the segment that is currently active.
2. Hold the Enter (↵) button down and press the Up (▲) button to move the cursor to the right. Hold the Enter (↵) button down and press the Down (▼) button to move the cursor to the left. Release the Enter (↵) button.
3. Once the segment that you want to change is selected:
 - Press the Up (▲) button to advance through the numbers then letters, (0 1 2 3 4 X Y Z).
 - Press the Down (▼) button to select letters then numbers, (Z Y X W 4 3 2 1 0).

Repeat steps 2 and 3 for all character positions in the Password or SuperWord.

NOTE: Initial factory set Password is 1.
Initial factory set Superword is 2.

4. When the Password or SuperWord is displayed, press the Enter (↵) button once.

NOTE: If an invalid Password or SuperWord is entered, the following message will appear:

Invalid password...

To make a correction, repeat steps 2 thru 4.

NOTE: To reset the SuperWord to factory default, use FlashWare. See "Reset Factory Defaults" on page 3-31.

5. What menus can be accessed will depend on whether SuperWord or Password was entered. Refer to Table 3-1.

Config is the first selection on the OD. If **Config** is the desired selection, press Enter (↵). If **Learn** or **Maint** is desired (available only if Program Mode is entered with SuperWord), use the Up/Down (▲▼) buttons to scroll to that menu, then press Enter (↵).

To exit Program Mode, use the Up/Down (▲▼) buttons to scroll to **Quit**, then press Enter (↵).

NOTE: If the output tests are selected in **Maint**, the OD will remind the service technician to jack the truck so the drive tire is off the floor and to open the emergency lowering valve while in Maintenance Mode. When **Ready?** appears on the OD, press Enter (↵) to enter Maintenance Mode output tests.

Entering Program Mode

Numbers and letters are displayed in each segment in the order shown below (then repeated) when the UP button is pushed repeatedly.



Pushing the DOWN button repeatedly scrolls the information in the opposite direction.

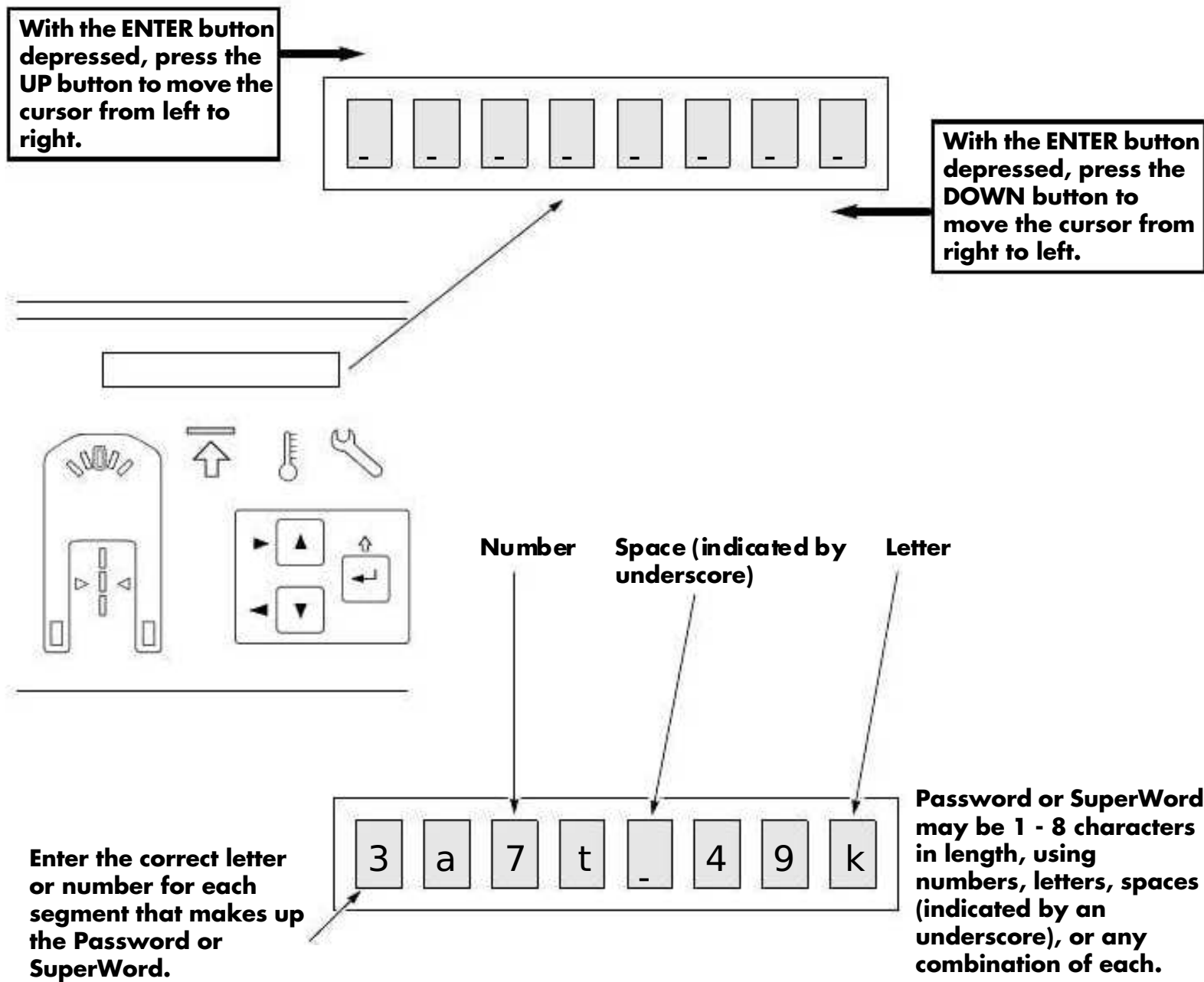

Figure 3-5. Operator Display for Program Mode (Example)

Learn Mode

Learn Mode is used to calibrate the control circuits to the operator controls and the truck's external sensors, [such as throttle (VR1), lift/lower potentiometer (VR2), and the optional flow sensor used with the advanced *intellispeed*[™] system].

After entering the SuperWord, **Config** is displayed on the OD (see Table 3-1 on page 3-11). Scroll Up/Down (▲▼) through the menu until **Learn** is displayed, then press Enter (↵). The alarm will beep, indicating that you are in Learn Mode.

Select the item you want to learn. Follow the instructions as they appear on the OD. **Learn** instructions will vary slightly between vehicles with different options. Instructions will repeat until they have been completed.

After the system is satisfied that the instructions on the OD have been followed, the alarm will beep and the next instruction will appear. This will continue until all required components are learned. After all steps have been satisfied, **Quit Lrn** is displayed, allowing **Learn** to be exited.

When to Run Learn

See Table 3-3 on page 3-20.

Learn Controls

Learn Controls is necessary on all trucks. During Learn Controls, the Vehicle Manager (VM) calibrates its control circuits to the output voltage from the Travel Potentiometer (VR1) and the Lift Potentiometer (VR2).

The VM measures and stores the neutral voltage value and the maximum forward and reverse voltage values from VR1. These values are used by the VM to determine direction and speed requested by the operator during Run Mode.

The VM also measures and stores the neutral and the maximum lift and lower voltage values from VR2. These values are used by the VM to determine if lift or lower is being requested and the percentage of full speed that is being requested.

Learn Hgt/Wgt

Learn Hgt/Wgt is only present if the *intellispeed* option is installed on the truck.

The VM interprets the height and weight inputs during Run. During Learn, the VM obtains a baseline for height and weight from where to calculate those parameters. The position of the upper and lower reference switches is part of the information that is installed into the trucks primary memory at the factory or as a result of a change with a Passkey.

When **Learn Hgt/Wgt** is performed, the carriage passes through both lower and upper reference switches. As hydraulic fluid flows through the Flow Sensor to move the carriage, the Flow Module produces two quadrature phased pulsed outputs to the VM. The VM counts and stores the number of pulses between the reference switches. The VM uses this information to determine the position of the carriage as the truck is operated during Run Mode.

The formula for calculating weight from the pressure transducer voltage is programmed into the VM, but it needs to know the reference voltage from where to start the calculation. It monitors and stores the voltage from the pressure transducer as the carriage is lifted between the reference switches during Learn. This value is used for the reference voltage for lifting an empty carriage.

After the carriage is lifted between the reference switches, the carriage will elevate about 12 in. and pause before lowering again. During this pause, the VM is storing the value that is produced from the pressure transducer when an empty carriage is elevated and stationary.

Entering Program Mode

Table 3-3. When to Run Learn

Component Repaired/Adjusted	Is Learn Required?		Portion of Learn to run
	Yes	No	
Vehicle Manager	Yes		Controls, Height, Weight, Steer
Upper Mast Switch	—	No	—
Lower Mast Switch	—	No	—
Carriage Control Card (CCC)	Yes	—	Controls
Carriage Control Card PROM	Yes	—	Controls
Steer Position Proximity Home Sensor	Yes	—	Learn Steer Zero or Learn
Deadman Switch (S2/S23)	—	No	—
Lift Potentiometer (VR2)	Yes	—	Controls
Guidance Manager	Yes	—	Frequency and Offset
Pressure Transducer	Yes	—	Height, Weight
Lift/Lower Solenoid	—	No	—
Load Holding Solenoid	—	No	—
Brake	—	No	—
Throttle Potentiometer (VR1)	Yes	—	Controls
Flow Sensor Module	Yes	—	Height, Weight
Filter Card	Yes	—	Frequency and Offset
Antenna Card	Yes	—	Frequency and Offset
Home Proximity Sensor	Yes	—	Steer

CAUTION

Before Learning height and weight, the vehicle must be placed in an area where the platform is able to lift beyond the upper mast reference switch (156 in. [396 cm] plus the height of the carriage).

When **Hgt/Wgt** is selected, the following message appears:

Carriage will automatically lift/ lower between the reference switches

The operator is prompted as follows:

Step on deadman to start learn

This message will scroll continuously until the operator steps on the deadman pedal. After the operator steps on the deadman pedal, the

carriage will immediately begin to lift. The display will continuously scroll the following message:

To abort, step off deadman

If all the parameters measured during **Learn** are within tolerance, the following message will appear:

Done learning

If, at any time during **Learn**, the operator steps off the deadman pedal or the measurements fall outside a tolerance, the following message appears:

Unable to learn...lower then press enter to continue

Entering Program Mode

If the failure is not the result of stepping off the deadman, attempt to learn again. If repeated attempts to learn fail, run tests:

- Test A13 - Pressure Sensor Voltage (optional) (Page 6-38)
- Test I02 - Lower Mast Reference (24 in.) Switch (Page 6-58)
- Test I69 - Upper Mast Reference Switch (Page 6-82)
- Test I26 - Flow Sensor Count (Page 6-70) (use active maintenance)

Learning Wire Frequency

Trucks equipped with an optional wire guidance system can be configured as follows. Three selections are available under **WireFreq** in **Config**.

If **5.2 kHz** or **6.25 kHz** is selected, the Guidance Manager utilizes preset guide wire strength values and calculates only the wire guidance offsets (**Wg Offset** must be run).

NOTE: The **5.2 kHz** setting requires a guide wire output of 100 mA. The **6.25 kHz** setting requires a guide wire output of 225 mA. **Other** must be selected for all other guide wire outputs.

If **Other** is selected, the Guidance Manager is calibrated to the frequency and amplitude of the guide wire in order to correctly calculate wire guidance offsets. Both scenarios are discussed in the following paragraphs.

Learn Wirefreq:

WireFreq is visible in the **Learn** menu only if **Other** is selected under **WireFreq** in **Config**. **WireFreq** must be learned before **Wg Offset** is attempted. When **Other** is selected, the Guidance Manager (GM) must learn the frequency and strength of the AC current flowing through the guide wire. This is done as follows:

1. Verify that the line driver is adjusted to the correct frequency and amplitude.
2. Center the lift truck over the guide wire to within ± 0.5 in. (± 13 mm).

3. Select **WireFreq** from the **Learn** menu and press Enter (↵). The following message appears:

Center over wire, Then press enter
After Enter (↵) is pressed, the following message is displayed:
Learning wire frequency.

NOTE: This process takes several seconds.

4. When the frequency and amplitude of the guide wire is learned, the following message is displayed:

Wr efr eq

5. Select **Quit Lrn** from the **Learn** menu and press Enter (↵) to exit Learn Mode. Cycle the key switch OFF, then ON. Re-enter Learn Mode prior to learning Wire Guidance Offsets.
6. If a valid frequency is not found, or if at any time during the learning process, the operator presses the Enter (↵) button, the following message is displayed:
Unable to learn. Press ENTER to continue.
7. If repeated attempts to learn wire frequency fail, run the following tests:
 - Test A51 - Left Tractor Guidance Coil Voltage (Page 6-49)
 - Test A52 - Right Tractor Guidance Coil Voltage (Page 6-50)
 - Test A53 - Left Load Guidance Coil Voltage (Page 6-51)
 - Test A54 - Right Load Guidance Coil Voltage (Page 6-52)
 - Test A55 - Tractor Near Wire Coil Voltage (Page 6-53)
 - Test A56 - Load Near Wire Coil Voltage (Page 6-54)

Learn Wire Guidance Offsets

For wire guidance to function correctly, the GM must calibrate its internal guidance circuits to the voltage it receives from each guidance coil on the Antenna Card. The GM must also know the straight ahead position of the drive unit.

Entering Program Mode

These values are obtained while learning the wire guidance offsets as follows:

NOTE: The **Coast** value in **Config** *must* be set to **Long** and the truck driven in the tractor-first direction.

1. Center the truck over the guide wire as closely as possible.
2. Set the Auto/Manual switch to Auto to initiate **Learn**.
3. Drive the truck tractor-first on the guide wire for at least 60 ft. Allow truck to coast to a stop. This is done to allow the truck to center correctly to its neutral position. If the brake or plugging is applied, the drive unit may shift position.
4. After the truck has coasted to a stop, place the Auto/Manual switch in the Manual position. When the Auto/Manual switch changes state, the GM stores the voltage it measured from each guidance sensor coil. This voltage value is used to determine the wire guidance offsets and establish the scale factors required to determine Heading Angle (HA) and Distance From Wire (DFW) when in Run mode.
5. When the truck powered up, it auto centered, and reset the pulse counter for steering position. As the truck was traveling on the wire in step 3, the Feedback Encoder was keeping track of the deviation of the drive unit from the auto center position. When the Auto/Manual switch changed states in step 4, the GM also stored the number of Feedback Encoder pulses between the Auto Center position and the position that the drive unit was located when the Auto/Manual switch changed state. That is the value that the GM uses as straight ahead when determining how to position the drive unit to keep the truck centered over the wire (sensor coil voltages at the learned value) as the truck drives on the wire.

If the truck was not centered over the wire when the Auto/Manual switch changed states in step 4, the GM would learn incorrect values (truck position) from the sensor coils. The GM would then attempt to keep the truck in a position other than

centered over the wire. If the drive unit was not straight ahead, the GM would learn an incorrect angle and the truck may wander on the wire. Re-learn the wire guidance offsets as many times as necessary to make the truck track within 0.5 in. (13 mm) of the guide wire.

6. If the Learn procedure is completed correctly, the following message is displayed:

Done learning.

The truck should guide centered over the guide wire.

If Enter (↵) is pressed during the Learn process, the session is aborted and the following message is displayed:

Unable to learn. Press ENTER to continue.

7. Run Tests A51 thru A56.

Learn Steer Zero

This procedure removes the need to manually adjust the Home Proximity Switch to make the truck track centered over the wire.

1. Center the truck over the guide wire.
2. Select **Learn Steer Zero**.
3. Place the Auto/Manual Switch in Auto and drive the truck in both directions over the guide wire. Maintain a speed of greater than 1.2 mph for more than 2 seconds. Once a change in speed of less than 1 mph has been seen for 2 seconds the Steer Zero position for that travel direction is stored and there will be a Beep.
4. After both travel directions have been completed select **Quit Lrn** from the **Learn** menu and press Enter (↵) to exit Learn Mode. Cycle the key switch OFF, then ON. Test the truck operation.

Learn Auto Steer Center

Use this procedure on trucks with rail guidance and auto steer centering option. Adjust the center position of the drive unit so that the truck drives straight when in the aisle.

1. Place the truck in an area where there is a straight line at least 20 ft. in length, with

wire guidance grooves, yellow aisle markers, or rails.

2. Depress the rail switch and secure it to simulate a rail.
3. Select Learn->Steer. the display will show "Str XXX" where XXX is a number between -50 and 50. This is the steer proximity offset from dead center in 10ths of degrees.
4. Step on the deadman pedal. Wait for the truck to self-center the drive unit.
5. Select manual on the auto/manual switch. The truck is now in "seeking mode" and can be driven with manual steering.
6. Position the truck so that it drives parallel to the reference line. Make small corrections in the steering wheel position until the truck can be driven 10 ft. without deviating from the line more than 1/2 in. without steering.
7. Drive back to the original position. Stop the truck. Select "Auto" on the Auto/Manual switch. The steer unit will center and manual steer is disabled.
8. Drive forward 10 ft. Measure the deviation of the truck from the reference line. The deviation should be less than one in. If more than one in. proceed to the next step. If it is less than one in. proceed to step 13.
9. Drive the truck back 10 ft. to the original position.
10. Use the Up/Down (▲▼) button arrows to adjust the value on the display. More negative numbers cause the truck to drive to the right when driven tractor first. Changing the value by one corresponds to a deviation of about 0.25 in. over 10 ft.
11. Repeat steps 9-11 until a deviation of one in. or less over ten ft. is achieved.
12. To save the value, press the enter button. The truck's display will read "Save? N." Press the Up/Down (▲▼) button arrows to display "Save? Y", then press the Enter (↵) button.
13. Learn of steer center is complete.

Entering Program Mode

Maintenance Mode

Maintenance Mode allows service technicians to test individual circuits within the system. Maintenance Mode is accessed through Program Mode after the SuperWord is entered. Refer to page 3-8 for information on procedures for accessing Maintenance Mode.

NOTE: If the test does not appear in the Maintenance Mode menu for an option when you think it should, either that option is not enabled (through Flashware) or the truck does not have the latest software.

General

NOTE: If you need to enter **Maint** several times to resolve a problem, it may save time if Superword is temporarily changed to a single digit code. Remember to re-enter the correct Superword when you are done.

CAUTION

Disconnecting wires or connectors to integrated circuits with power ON can result in premature failure of those or other components. Always disconnect the battery before making or breaking any connections.

When removing a connector, do not pull on the wires to separate the connection.

All circuit cards are conformal coated. When testing circuit cards, make sure a good electrical connection is made between the board test point and the probe. This will eliminate false results.

WARNING

During Static Maintenance Output Tests, always jack the drive tire off the floor and open the Emergency Lowering Valve.

Use extreme care whenever the truck is jacked up for any reason. Never block the truck between the telescopic and the floor. Use a suitable hoist to stabilize the mast. Keep hands and feet clear from beneath the vehicle while jacking. Use jack stands or solid blocks to support truck - do not rely on jacks. Refer to page 2-8.

By entering Static Maintenance Mode, the safety circuits associated with the system are disabled. Extra precautions must be exercised in Static Maintenance Mode. Follow all instructions contained in this manual for each test. If you are unsure how to conduct a test while in Maintenance Mode, do not proceed with the test. Contact a certified Raymond[®] technician.

Static Maintenance Mode

In Static Maintenance Mode, the truck is inoperative. This mode allows the technician to test and operate individual circuits without operating the truck. All tests are available during static testing.

If Digital Outputs are selected from **Maint**, the OD will display:

Warning jack up the drive wheel, press enter when ready

Press Enter (↵) to start Maintenance Mode. The Up/Down (▲▼) buttons are used to turn the test ON/OFF.

Active Maintenance Mode

Active Maintenance Mode (Act Maint) permits testing of various systems on the lift truck. In Active Maintenance, all Analog and Digital tests can be selected with the results displayed while operating the truck in Run Mode. To enable a test for Active Maintenance, proceed as you

would for Static Maintenance Mode. When the Analog or Digital test you want is displayed, press Enter (↵). An asterisk (*) will appear next to the test number indicating that this test is selected for Active Maintenance.

All tests can be selected. Individual tests can be turned OFF by going back to that test in **Maint** and pressing Enter (↵). The asterisk will disappear. The tests selected for Active Maintenance are stored in memory even if the key switch is turned OFF.

To select one of the Active Maintenance tests, press the deadman pedal and use the Up/Down (▲▼) buttons to select the test you want displayed while operating the truck. The test selected will remain on the display until another test or display selection is made.

Power Amplifier Reset

Power Amplifier Reset (PA Reset) returns the power amplifier back to its default baud rate of 125K. This feature is helpful when the power amplifier is to be returned to stock or installed on a different model truck.

Event Log

The Event Log (Evtlog) stores the last twenty error codes recorded on the lift truck. Entries are stored in order of occurrence, with the most recent error first.

To access the Event Log, use the Up/Down (▲▼) buttons to scroll to **Evtlog** and press Enter (↵).

If no errors are stored, **Empty** is displayed.

If errors have been logged, use the Up/Down (▲▼) buttons to scroll through the list.

To clear the log, use the Up/Down (▲▼) buttons to scroll to **Clr log**. Press Enter (↵). Scroll to **Clr yes** and press Enter (↵).

FlashWare Program

FlashWare Program

Overview

The FlashWare program allows you to update software and view and configure options on your Model 5400, 5500, and 5600 through the following features:

- Vehicle Manager software
- Clear primary memory
- Reset factory default settings
- Power Amplifier Software

NOTE: For more detailed information with FlashWare, click on Help, the Help Topics from the menu bar.

Requirements

FlashWare can be installed on an IBM-compatible PC with Windows 98 or higher operating system. The PC communicates with the truck software through a 9-pin serial cable.

CAUTION

We recommend using the surge protector (P/N 154-010-801) to protect your PC from possible electrostatic discharge or voltage surge.

Install FlashWare on PC

If you are a customer service technician, obtain FlashWare from your Raymond dealer.

If you are a Raymond dealer technician, obtain FlashWare from the iNet software download site. If you do not have access to the download page on iNet, contact the Parts Distribution Center.

To install FlashWare on the PC, double-click the installation file and follow the instructions on the screen. The software package is a self-extracting executable file. Read the "Readme" file in the software package for the latest detailed installation instructions.

PC Connection to Truck

1. Turn the truck key switch OFF.

2. Connect the surge protector to an available com port on your computer.

CAUTION

We recommend using a surge protector (P/N 154-010-801) to protect your PC from possible electrostatic discharge or voltage surge.

3. Connect a standard 9-pin serial cable to the surge protector.
4. Connect the cable to JPT-9 at the VM.
5. Turn the key switch ON.

Starting FlashWare

From Windows 98 or Higher

1. Make sure the truck key switch is ON.
2. Double-click the **FlashWare** icon on the main desktop screen or navigate via Start > Programs > FlashWare. The truck opening screen will appear. See Figure 3-6.



Figure 3-6. Truck Opening Screen

NOTE: When entering or using FlashWare, it is normal for the vehicle to display a Code 50.

3. From the menu bar, click Connect to Truck. The truck setup screen will appear on your PC screen. See Figure 3-7.

Every 360 Days or 2000 Deadman Hours (HD)

Every 360 Days or 2000 Deadman Hours (HD)

Perform the following maintenance tasks every 360 days or 2000 HD, whichever comes first.		
Component	What to do	Refer to
Drive Unit	Change fluid.	Page A-2
Hydraulic Reservoir	Change fluid and filter.	Page A-2
Lift Pump	Separate lift pump and motor. Apply molybdenum anti-seize compound (P/N 990-638) to the splines.	Page 7-82

Chain Maintenance

Chain Maintenance

Condition	Cause	Maintenance Procedure
Chain Elongation	Wear	Use a chain gauge or lay the chain on a flat surface and push it together. Measure and mark a 12 in. (305 mm) length that has operated over the pulley sheave. Stretch the chain; if more than 1/3 in. (8.5 mm) play is detected, replace the chain.
Rust and corrosion	Steam cleaning or degreasing new truck chains.	Oil chain frequently.
Cracked Plates	Infrequent Oiling Rust Corrosion Chain Fatigue	Replace the chain.
Tight Joints	Bent pins or plates	Replace the chain.
	Rusty joints or peened plate edges	Replace the chain.
Chain side wear	Chain misalignment	Replace the chain.

Section 5. Troubleshooting

Electrical Troubleshooting

Electrical Troubleshooting

General

⚠ WARNING

Block the lift truck so that the drive tire is off the floor whenever a troubleshooting procedure requires turning the key switch ON. This will prevent accidents caused by unexpected lift truck travel. Opening the Emergency Lowering Valve will prevent unexpected lifting.

⚠ CAUTION

Unless otherwise directed, disconnect the battery connector when you check electrical circuits or components with an ohmmeter. Electrical current can damage an ohmmeter. Discharge residual charge in the motor controller by pressing the PC and P contactors closed simultaneously.

- When measuring voltage, connect the positive meter lead to the connector or probe point marked (+) in the test. Connect the negative meter lead to the connector or probe point marked (-).
 - Whenever measuring resistance, turn the key switch OFF and disconnect the battery connector. Battery current can damage an ohmmeter. Isolate the component from the circuit.
- Many problems are caused by a faulty or dirty battery. Make sure the battery is clean.
 - Save time and trouble by looking for simple causes first.
 - For information on electrical connector location and function, see “Electrical Connector Locations” on page 5-14.
 - Use a Digital Multi Meter (DMM) such as a Fluke meter for all measurements. Analog meters can give inaccurate readings and load down sensitive electronic circuits enough to cause failure. Make sure meter cables are connected to the correct meter jacks and that the correct function and scale are selected.
 - Printed circuit boards are conformal coated. Clean test points in order to obtain accurate readings.

Battery State-of-Charge

Battery State-of-Charge (BSOC) is an option that monitors and remembers the charge level of the battery connected to the truck and prevents excessive discharging of that battery. Operating a truck using a discharged battery can damage both the battery and the electrical components in the truck's electrical system.

At power-up, BSOC tests the battery to determine if it is the same battery that was installed at power-down. If it is the same battery, it continues to monitor the battery for discharge and updates the OD as required.

If a different battery is detected, BSOC tests to determine the state-of-charge of the new battery as follows:

1. BSOC computes the difference between the charge of the battery that was connected to the truck and the charge of the new battery. A charge difference of at least 50% between the two batteries resets BSOC to show the state-of-charge of the new battery (for example - the displayed state-of-charge of the new battery minus the displayed state-of-charge of the old battery must equal or exceed 50%). This reset can be higher or lower than the old battery. Example - A battery in the truck is at 10% charge; the new battery is at 95%. With more than a 50% difference in the charge levels, BSOC will reset the OD to show the new battery's charge.
2. BSOC looks at the configured reset point. BSOC reset is programmable from 55 to 100 of total battery charge and can be changed by entering Configure Mode using the Superword. The new battery must be equal to or greater than the configured percent of charge before the BSOC will change. Example - BSOC configured at 95. Plugging in a battery at anything below 95% charge will not change the OD. Older batteries may require a lower configured value for BSOC since older batteries may be unable to reach a higher percent charge. Therefore, older batteries may require BSOC configure to 85 before the

OD will reset to show the charge of the new battery.

Either Step 1 or 2 will cause BSOC to reset.

The following examples describe installing a new battery where the OD does not reset.

Assume the following:

- **Example 1:** BSOC is configured at 95, the battery connected is at a calculated 45% charge and the new battery is at a calculated 92% charge.

Since the new battery charge has not changed by at least 50% and the state-of-charge of the new battery is not greater than the BSOC reset configured value, the OD will continue to show the old battery's charge of 45% (even though the new battery is at 92%). The OD will remain at 45% until the charge of the new battery declines to 45%. The display will then resume its normal descent.

- **Example 2:** BSOC is configured at 95, the battery connected is at a calculated 65% charge and the new battery is at a calculated 20% charge.

Again, the change in charge is not at least 50% and the new battery is not above the configured BSOC level. The OD will continue to show 65%, but then descends rapidly as the truck operates until the OD shows the original charge of 20%. Once the display shows 20% it resumes a normal descent.

NOTE: If the displayed BSOC is suspected to be inaccurate, check for Code FE. See Code FE: Internal VM Circuit for BSOC Not Calibrated (Page 6-27).

Lift Cutout Adjustment

See Figure 5-1 for a graphic representation of the BSOC process.

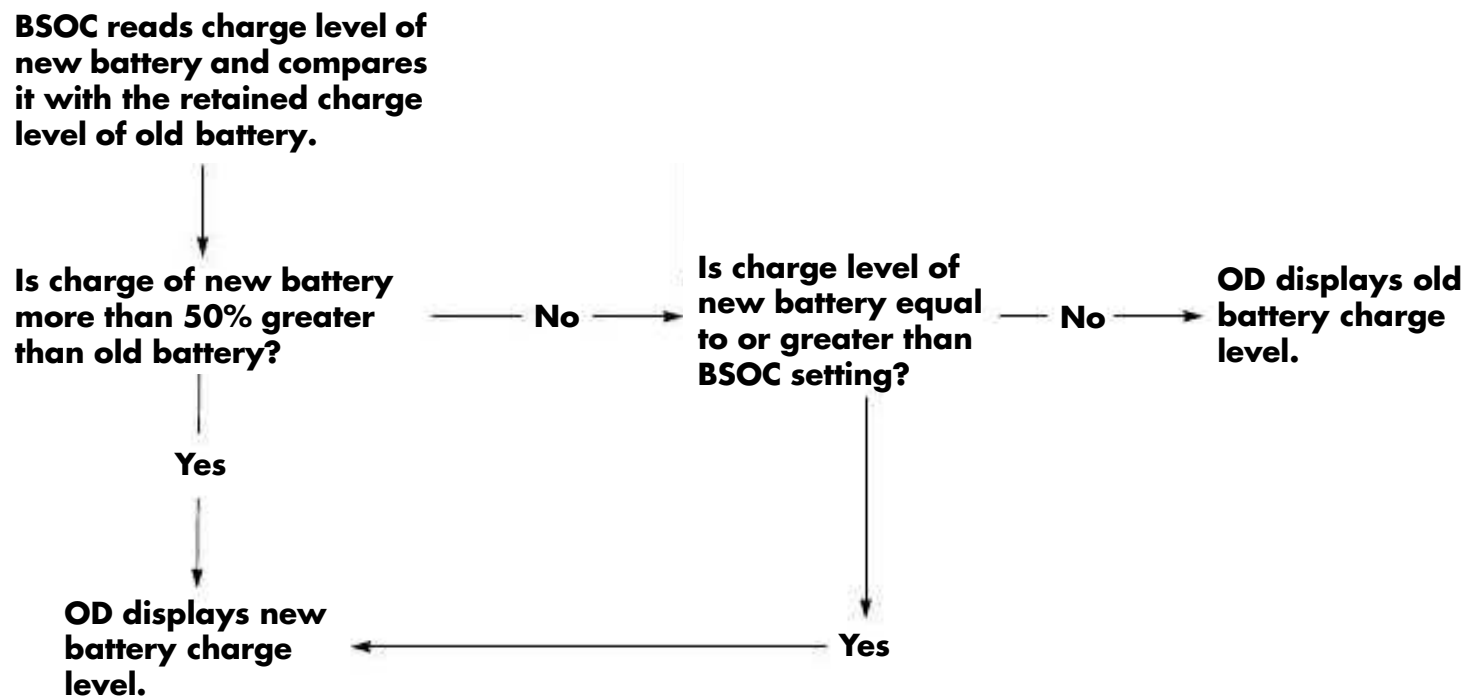

Figure 5-1. Battery State-of-Charge Process

5

Lift Cutout Adjustment

1. Run truck until lift cutout is activated.
2. Allow battery to set unused for two hours. Check SG and compare to manufacturer's recommendations.
3. Adjust cutout in **Config** until correct discharge is obtained.

NOTE: Additional BSOC adjustment is available using FlashWare. See "BSOC Calibration" on page 3-31.

Electrostatic Discharge

Electrostatic discharge can cause certain fault codes, such as FP or FT. Over time, electrostatic discharge can damage circuit cards. Static tends to be higher in environments with low relative humidity, such as freezers. See Electrostatic Discharge Precautions on page 2-7.

Make sure static straps are installed on the truck and work correctly.

Fuses

Table 5-1 lists the fuses for a truck with all available options. Not all trucks will have all of the fuses listed.

Table 5-1. Fuses

Fuse	Function	Location	Amps
FU1	Power Fuse for Steer Power Amplifier	Contactor Panel	100
FU2	Power Fuse for Traction Power Amplifier		350
FU3	Power Fuse for Lift Power Amplifier - Model 5500, 5600		500
	Power Fuse for Lift Motor - Model 5400		350/Hi-Pro - 500
FU5	Control Fuse for Vehicle Manager B+	Fuse/Relay Card	15
FU6	Control Fuse for Vehicle Manager B-		15
FU7	Control Fuse for Aux Power B+		15/5
FU8	Control Fuse for Aux Power B-		15/5
FU9	Control Fuse for RF Terminal B+	Carriage Console Plate	2
FU10	Control Fuse for RF Terminal B-		2
FU21	Control Fuse for Cold Storage CCC Heater	CCC Heater Plate	10
FUDM	Control Fuse for Cold Storage Deadman Heater	Carriage Console Plate	5

DC Motor Troubleshooting

DC Motor Troubleshooting**Motor Types**

Refer to Figure 5-2.

- A series-wound motor has only two external connections because the armature and field windings are connected internally.
- A permanent magnet motor has two external connections. The field is produced by an internal magnet.

NOTE: Field connections may be labeled A or S. Series wound motor field connections may be labeled D.

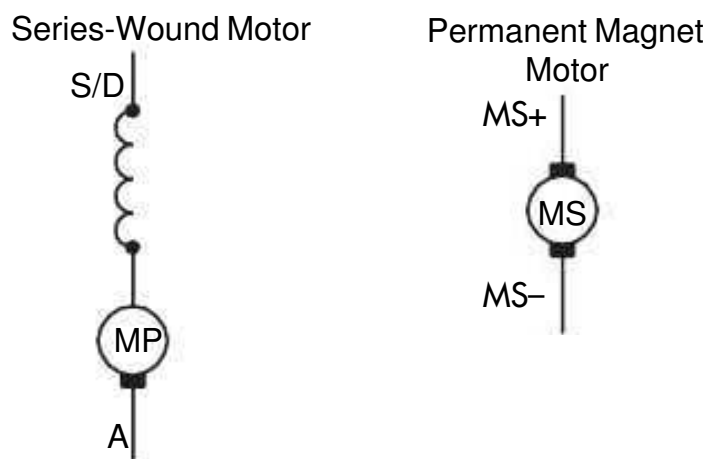

Figure 5-2. Motor Circuits

Inspection

The commutator must be inspected for surface condition and high mica. Most armatures have the mica undercut. If the armature on your motor does not, do not attempt to cut it.

The commutator must be smooth and clean to provide maximum brush wear. When commutators are not correctly maintained, carbon dust can collect in the grooves between the segments. This can lead to a short circuit in the armature.

Good commutation is indicated by a dark brown polished commutator and an evenly polished brush wearing surface. See Table 5-2, "Commutator Surfaces."

If the commutator appears rough, pitted, or has signs of burning or heavy arcing between the commutator bars, remove the motor for servicing.

Servicing

If the commutator requires service, you will need to remove the armature from the motor.

Do not use a stone to even out high and low spots on the commutator. Use only a suitable abrasive rubber polisher.

Servicing a motor for an abnormal commutator surface condition and high mica or mica undercutting requires special equipment at a motor rebuilding facility.

Drive Unit Troubleshooting

Refer to page 7-23 for standard drive unit repair procedures and page 7-42 for heavy duty drive unit repair procedures.

Symptom	Probable Cause	Required Action
Oil leaks	Damaged sealing rings	Replace sealing rings, bearing shims, and drive shaft bearings.
	Worn or damaged drive shaft	Replace sealing rings, bearing shims, drive shaft bearings, and drive shaft.
	Housing/cover joint	Reseal
	Worn or damaged housing	Replace drive unit.
Drive wheel wobbles	Worn or damaged drive shaft bearings	Replace sealing rings, bearing shims, and drive shaft bearings.
	Worn or damaged drive shaft	Replace sealing rings, bearing shims, drive shaft bearings, and drive shaft.
	Loose wheel mounting hardware	Inspect housing and drive shaft for damage; Re-torque mounting hardware.
Noise	Worn or damaged drive shaft bearing	Replace sealing rings, bearing shims, and drive shaft bearings.
	Worn or damaged pinion bearings	Replace pinion bearing and pinion shaft nut.
	Worn or damaged gear set (drive shaft is in good condition)	Replace sealing rings, bearing shims, drive shaft bearings, pinion bearings, pinion shaft nut, and gear set.
	Worn or damaged gear set (drive shaft is worn or damaged)	Replace sealing rings, bearing shims, drive shaft bearings, pinion bearings, pinion shaft nut, gear set, and drive shaft.
	Worn or damaged helical gear and pinion	Replace helical gear and pinion.
Steering binds	Inadequate bearing lubrication	Grease steering bearing.
	Worn or damaged steering bearing	Replace radial rings and ball bearings.

Communication Error Code Troubleshooting

Communication Error Code Troubleshooting**Intermittent Communication Codes**

If possible, determine what the operator was doing when the codes were generated; driving, plugging, lifting, sounding horn, and so on.

Focus on these circuits for shorts to frame and external noise being generated that can interfere with the communication circuits. Determine where in the SelfTest Cycle the code is generated (for instance, when the drive motor is energized or when the horn was sounded).

Intermittent Codes During SelfTest

Make sure the key switch is turned OFF for at least 5 seconds before turning it back to the ON position. Test the key switch for high resistance. If nothing is found in the following steps, replace the key switch.

Test for shorts to frame. See Shorts to Frame Test on page 5-11.

If equipped with optional light/fan package, disconnect PC5. If code goes away, troubleshoot light/fan circuitry.

NOTE: The condition of the light/fan suppressor module cannot be checked with a DMM. If the suppressor module is suspected to be bad, replace it.

During Travel and/or Plugging

If truck is equipped with optional travel alarm, disconnect wires to the relay. If code goes away, troubleshoot travel alarm circuitry.

NOTE: The condition of the travel alarm suppressor module cannot be checked with a DMM. If the suppressor module is suspected to be bad, replace it.

Test and clean static straps.

Test for shorts to frame. See Shorts to Frame Test on page 5-11.

Communication Code Every Time Key Is Turned ON

Troubleshoot per code on display using Test I23 - CAN Bus (Page 6-66).

Troubleshooting Procedure

5

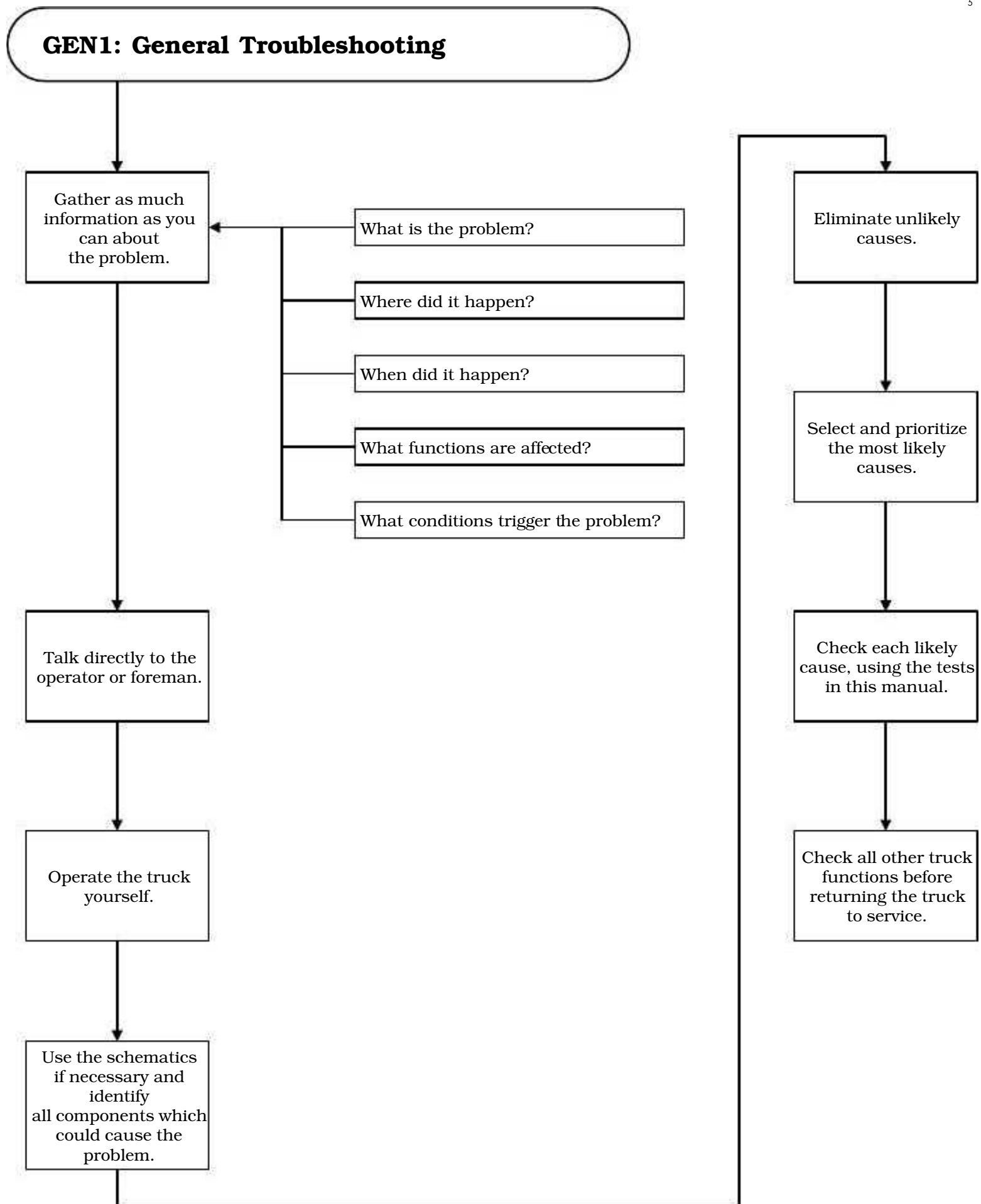

Troubleshooting Procedure

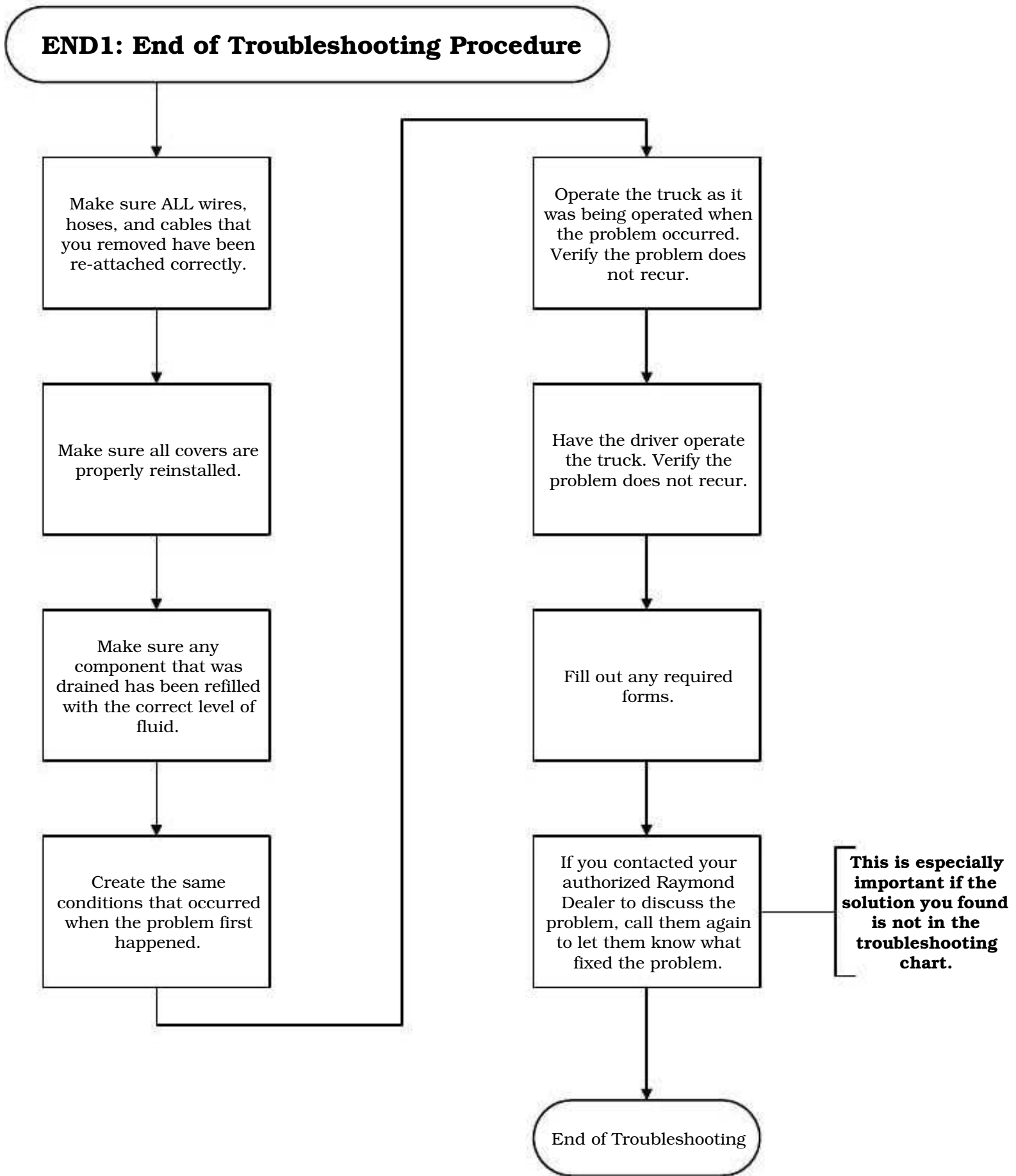

Symptom Tables: Hydraulic Functions

NOTE: If it is determined that a component failed as a result of hydraulic fluid contamination, replace the failed component and flush, fill, and bleed the hydraulic system.

NOTE: Reference schematics on page A-11.

Intermittent Lift/Lower

Possible Cause	Action
Bad wiring	Check wiring harnesses between valves and VM.
Hydraulic contamination (can cause binding proportional valve or load holding solenoid)	Replace damaged component and flush, fill, and bleed the hydraulic system.

Lift Function

No Lift - Carriage: Lift motor does not run

Possible Cause	Action
Bad battery	Adjust lift cutout as necessary. Replace battery with fully charged battery.
Bad optional lift limit switch	Run Test I05 - Lift Inhibit Switch (optional) (Page 6-62) and Test I04 - Lift/Lower Inhibit Bypass (optional) (Page 6-61).

Slow Lift - Carriage: Lift motor runs

Possible Cause	Action
Bad battery	Adjust lift cutout as necessary. Replace battery with fully-charged battery. Test battery for bad cells. See Battery Procedures on page 7-62.
Emergency lowering valve not seated correctly	Make sure emergency lowering valve is closed. Check for contamination. If contamination is present, clean valve, flush, fill, and bleed the hydraulic system.
Bad proportional lift/lower valve	Inspect for binding. Run Test O12 - Proportional Solenoid PWM Ramp (Page 6-95).
Relief valve REL1 stuck open	Test system pressure. Check for contamination. If contamination is present, replace valve, flush, fill, and bleed the hydraulic system.
Plugged or malfunctioning flow control valve in lift cylinder	Check for contamination in hydraulic fluid. If contamination is present, inspect and clean the relief valve, replace the flow control valves, flush, fill, and bleed the hydraulic system.
Bad lift pump	Test system pressure.

Symptom Tables: Hydraulic Functions

Possible Cause	Action
Binding in the mast	Inspect the mast and bearings for signs of binding.
Bad lift motor	DC Lift Trucks: Test lift motor. See DC Motor Troubleshooting on page 5-6. Check amp draw. AC Lift Trucks: Run Test O28 - Ramp Lift Motor (AC lift only) (Page 6-100).
Bad Lift Motor Encoder	Run Test I20 - Lift Motor RPM (AC lift only) (Page 6-65)

Unable to Pick Up a Load

Possible Cause	Action
Battery problems	Adjust lift cutout as necessary. Replace battery with fully-charged battery. Test battery for bad cells. See Battery Procedures on page 7-62.
Incorrect lift pressure adjustment	Check and adjust lift pressure setting.
Bad lift pump	Test system pressure.
Bad lift motor	DC Lift Trucks: Test lift motor. See DC Motor Troubleshooting on page 5-6. Check amp draw. AC Lift Trucks: Run Test O28 - Ramp Lift Motor (AC lift only) (Page 6-100).

Lower Function**Slow Lower**

Possible Cause	Action
Binding proportional valve	Check valve operation. Run Test O12 - Proportional Solenoid PWM Ramp (Page 6-95).
Mechanical binding in bearings or telescopic	Adjust or replace bearings. If still slow, check shimming.
Plugged or malfunctioning flow control valve	Open Emergency Lower Valve. If still slow, remove and inspect flow control valves. Check for contamination in hydraulic fluid. If contamination is present, inspect and clean the relief valve, flush, fill, and bleed the hydraulic system. If no contamination is found, replace the flow control valves in the main lift cylinders.

Intermittent Lower

Possible Cause	Action
Bad load hold solenoid	Run Test O11 - Toggle Load Holding Solenoid (Page 6-94).
Binding proportional valve	Check valve operation. Run Test O12 - Proportional Solenoid PWM Ramp (Page 6-95).

Symptom Tables: Hydraulic Functions

Possible Cause	Action
Plugged or malfunctioning flow control valve	Open Emergency Lower Valve. If still slow, remove and inspect. Check for contamination in hydraulic fluid. If contamination is present, inspect and clean the relief valve, flush, fill, and bleed the hydraulic system. If no contamination is found, replace the flow control valves in the main lift cylinders.

Load Drifting/Settling

Possible Cause	Action
Incorrect lift pressure adjustment	Check and adjust lift pressure setting.
Load holding solenoid	Run Test O11 - Toggle Load Holding Solenoid (Page 6-94). Check for contamination in hydraulic fluid. If contamination is present, inspect and clean the relief valve, flush, fill, and bleed the hydraulic system.
Load too large for lift truck capacity	Check load weight. Check lift pressure setting.
Emergency Lower Valve leaking	Replace valve.

Symptom Tables: Travel Functions

Symptom Tables: Travel Functions**Slow or Sluggish Acceleration**

Possible Cause	Action
Dragging brake	Adjust brake.
Worn wheel bearings	Replace wheel bearings.
Debris in wheel axle	Remove debris.
Binding drive unit	Remove motor and check movement.

Slow Travel

Possible Cause	Action
Note: Determine if problem is mechanical or electrical.	
Mechanical:	
Dragging brake	Adjust brake.
Debris in wheel axle	Remove debris.
Binding drive unit	Remove motor and check movement.
Binding in control handle	Run Test A22 - Traction Throttle Request (Page 6-43) to determine if the controller is still seeing a 100% request.
Electrical:	
Bad mast speed limit switch (S10 or S11) or associated wiring	Run Test I02 - Lower Mast Reference (24 in.) Switch (Page 6-58), Test I69 - Upper Mast Reference Switch (Page 6-82), or Test I03 - 60 in. Limit Switch (Page 6-59).
Incorrect configuration	Reconfigure the lift truck.
Speed limited due to drive motor or power amplifier temperature (temperature icon illuminated)	Run Test A08 - Traction Motor Temperature (Page 6-34), Test A10 - Traction Power Amplifier Temperature (Page 6-36).
Bad encoder pulses from drive motor encoder	Run Test I19 - Traction Motor RPM (Page 6-64)

Message Displayed: CODE 51 Inform service

Icon	Code Title/Reason	Tests to Run	Notes/Corrective Action
Message Displayed: CODE 51 Inform service			
	Code 51: No CCC Communications Received by VM The VM has not received correct communications from the CCC.	Test I23 - CAN Bus (Page 6-66)	All functions disabled. See Communication Error Code Troubleshooting on page 5-22 . Cycle key switch to clear.

Message Displayed: CODE 59 Inform service

	Code 59: CAN Transmission Buffer Error The VM has detected a CAN transmission buffer error.	Test I23 - CAN Bus (Page 6-66)	All functions disabled. See Communication Error Code Troubleshooting on page 5-22 . Cycle key switch to clear.
---	---	--	--

Message Displayed: CODE 5A Inform service

	Code 5A: CAN BUS Error Overflow CAN BUS error overflow detected by VM.	Test I23 - CAN Bus (Page 6-66)	All functions disabled. See Communication Error Code Troubleshooting on page 5-22 . Cycle key switch to clear.
---	--	--	--

Message Displayed: CODE 5E Inform service

	Code 5E: No Guidance Manager CAN Communications Received by the VM	Test I23 - CAN Bus (Page 6-66)	Travel disabled in AUTO mode. Travel allowed in MANUAL mode. Cycle key switch to clear.
---	---	--	---

Message Displayed: CODE 5G Inform service

	Code 5G: No Communications Received by VM from TPA The VM has not received CAN communications from the traction power amplifier.	Test I23 - CAN Bus (Page 6-66)	Travel is disabled. Cycle key switch to clear.
---	--	--	--

Message Displayed: CODE 5J Inform service

	Code 5J: No communications Received by VM from LPA AC Lift only - The VM has not received CAN communications from the lift power amplifier.	Test I23 - CAN Bus (Page 6-66)	Lift is disabled. Cycle key switch to clear.
---	--	--	--

Message Displayed: CODE 61 Inform service

Icon	Code Title/Reason	Tests to Run	Notes/Corrective Action
Message Displayed: CODE 61 Inform service			
	Code 61: 24 in. Limit Switch Not Sensed Too much time has passed without crossing 24 in. limit switch while lift request is above a certain threshold.	Test O12 - Proportional Solenoid PWM Ramp (Page 6-95) Test I02 - Lower Mast Reference (24 in.) Switch (Page 6-58)	Travel is limited to 2.5 mph. Make sure Emergency Lower Valve is closed. Cycle key switch to clear.

Message Displayed: CODE 63 Inform service			
	Code 63: Upper and Lower Reference Switches Do Not Agree The VM has sensed that the positions of the upper (S10) and the lower (S11) reference switches were out of sequence.	Test I02 - Lower Mast Reference (24 in.) Switch (Page 6-58) Test I69 - Upper Mast Reference Switch (Page 6-82)	Travel is limited to 1 mph. Cycle key switch to clear.

Message Displayed: CODE 64 Inform service			
	Code 64: No Flow Sensor Pulses When Lift/Lower Requested No pulses were seen from the flow sensor when lifting past one of the two mast reference switches (24 and 150 in.). (<i>intellispeed</i> only)	Test I02 - Lower Mast Reference (24 in.) Switch (Page 6-58) Test I26 - Flow Sensor Count (Page 6-70) Test I69 - Upper Mast Reference Switch (Page 6-82)	Travel is limited to 1 mph. Lift or lower past one of the mast reference switches. Cycle key switch to clear.

Message Displayed: CODE 66 Inform service			
	Code 66: Calculated Height Does Not Match at Upper Reference Switch (150 in.) <i>intellispeed</i> count and calculated height of the upper reference switch (S10) are out of tolerance. (<i>intellispeed</i> only)	Test I26 - Flow Sensor Count (Page 6-70) Test I69 - Upper Mast Reference Switch (Page 6-82)	Travel is limited to 1 mph. Cycle key switch to clear.

Message Displayed: CODE 67 Inform service			
	Code 67: Calculated Height Does Not Match at Lower Reference Switch (24 in.) <i>intellispeed</i> count and calculated height of the lower reference switch (S11) are out of tolerance. (<i>intellispeed</i> only)	Test I02 - Lower Mast Reference (24 in.) Switch (Page 6-58) Test I26 - Flow Sensor Count (Page 6-70)	Travel is limited to 1 mph. Cycle key switch to clear.

Message Displayed: CODE 6D Inform service

Icon	Code Title/Reason	Tests to Run	Notes/Corrective Action
Message Displayed: CODE 6D Inform service			
	Code 6D: Lift Pressure Sensor Out-of-Range The VM has determined that the pressure sensor voltage has exceeded the programmed limits. <i>(intellispeed only)</i>	Test A13 - Pressure Sensor Voltage (optional) (Page 6-38)	Code is displayed for five seconds. Display will then change to "----". Cycle key switch to clear.

Message Displayed: CODE 6F Over heated Allow time to cool			
	Code 6F: Lift Motor Overheated AC Lift only - Lift motor temperature has exceeded 300°F (149°C).	Test A09 - Lift Motor Temperature (Page 6-35)	Lift is disabled. Allow time to cool. Cycle key switch to clear.

Message Displayed: CODE 6K Inform service			
	Code 6K: 60 in. Switch Does Not Agree with Lower Mast Reference The 60 in. switch (S28) is out of sequence with the lower reference switch (S11). <i>(non-intellispeed only)</i>	Test I02 - Lower Mast Reference (24 in.) Switch (Page 6-58) Test I03 - 60 in. Limit Switch (Page 6-59)	Travel is limited to 2.5 mph. Lower, then lift past the first mast limit switch (S11), then cycle key switch to clear.

Message Displayed: CODE 6M Inform service			
	Code 6M: 60 in. and/or 24 in. Switch Disconnected The system detected that the 60 in. (S28) and/or the 24 in. (S11) switch are disconnected.	Test I02 - Lower Mast Reference (24 in.) Switch (Page 6-58) Test I03 - 60 in. Limit Switch (Page 6-59)	Lower, then lift past the lower reference switch (S11). Cycle key switch to clear.

Message Displayed: CODE 6N Inform service			
	Code 6N: Flow Sensor Temperature Out-of-Range The VM has sensed that the voltage is out-of-range. <i>(intellispeed only)</i>	None	Cycle key switch to clear. Only shown during Learn. Learn values will still be stored.

Message Displayed: CODE 6P Inform service			
	Code 6P: 60 in. Limit Switch Out-of-Sequence with Upper Reference Switch The system senses that the 60 in. limit switch and the upper reference switch are out of sequence. <i>(non-intellispeed only)</i>	Test I03 - 60 in. Limit Switch (Page 6-59) Test I69 - Upper Mast Reference Switch (Page 6-82)	Travel limited to 1 mph. Cycle key switch to clear.

Message Displayed: CODE 7E Inform service

Icon	Code Title/Reason	Tests to Run	Notes/Corrective Action
Message Displayed: CODE 7E Inform service			
	Code 7E: Lift Motor Temperature Sensor Out-of-Range Lift motor temperature sensor voltage is out-of-range.	Test A09 - Lift Motor Temperature (Page 6-35)	Lift performance is disabled by power amplifier. Cycle key switch to clear.

Message Displayed: CODE 7F Inform service			
	Code 7F: LPA Temp Out-of-Range The lift power amplifier has reported its internal temperature is less than -40°F (-40°C) or greater than +203°F (+95°C).	Test A19 - Lift Power Amplifier Temperature (AC lift only) (Page 6-41)	Lift is disabled. Cycle key switch to clear.

Message Displayed: CODE 7G Inform service			
	Code 7G: LPA Motor Phase Open The lift power amplifier has detected no current draw in one of the three phases of the motor.	Test O28 - Ramp Lift Motor (AC lift only) (Page 6-100)	Lift is disabled. Cycle key switch to clear.

Message Displayed: CODE 7H Inform service			
	Code 7H: Failure Detected in Lift Motor Feedback Encoder The lift power amplifier has detected incorrect pulses from the lift motor encoder.	Test I20 - Lift Motor RPM (AC lift only) (Page 6-65)	Lift is limited to approx. 10 feet per minute. Cycle key switch to clear.

Message Displayed: CODE 7M Inform service			
	Code 7M: LPA Failed to Precharge The lift power amplifier failed to precharge.	None	Lift is disabled. If cycling the key switch does not clear this code, the amplifier must be replaced. The VM cannot cause this code.

Message Displayed: CODE 7T Inform service			
	Code 7T: LPA Current Sensor Fault Internal lift power amplifier circuitry that measures current has detected a fault.	None.	Lift is limited to 60% of maximum request. If cycling the key switch does not clear this code, the amplifier must be replaced. The VM cannot cause this code.

Message Displayed: CODE 7U Inform service

Icon	Code Title/Reason	Tests to Run	Notes/Corrective Action
Message Displayed: CODE 7U Inform service			
	Code 7U: LPA Overcurrent or Short Circuit The lift power amplifier has sensed current in excess of 500A.	None	Lift is disabled. Cycle key switch to clear. The VM cannot cause this code.

Message Displayed: CODE 7V Inform service			
	Code 7V: LPA High Voltage on DC BUS The lift power amplifier has detected that the voltage at the + terminal is overvoltage.	None	Lift is disabled. Test voltage at LPA+. If OK, replace LPA. Cycle key switch to clear. The VM cannot cause this code.

Message Displayed: CODE 7W Inform service			
	Code 7W: LPA Internal Fault Internal coil driver sensed open or shorted.	None	Cycle key switch to clear. If code will not clear, replace lift power amplifier. The VM cannot cause this code.

Message Displayed: CODE 7X Inform service			
	Code 7X: LPA Power Supply Out-of-Range The power supply output in the lift power amplifier is less than 4.5V, greater than 5.5V or too much current is being drawn by an external component.	None	Cycle key switch to clear. Disconnect (+) wire to temp and speed sensors. If OK, troubleshoot wires and sensors. If code will not clear, replace lift power amplifier. The VM cannot cause this code.

Message Displayed: CODE 7Y Inform service			
	Code 7Y: Incorrect Lift Power Amplifier Installed (AC lift only)	None	Replace with correct power amp.

Message Displayed: CODE 80 Inform service			
	Code 80: Throttle Potentiometer (VR1) Voltage Out-of-Range	Test A04 - Throttle Potentiometer Voltage (Page 6-32)	Travel is disabled. Cycle key switch to clear.

Message Displayed: CODE 81 Inform service

Icon	Code Title/Reason	Tests to Run	Notes/Corrective Action
Message Displayed: CODE 81 Inform service			
	Code 81: Lift/Lower Potentiometer (VR2) Voltage Out-of-Range	Test A05 - Lift/Lower Potentiometer Voltage (Page 6-33)	Lift is disabled. Cycle key switch to clear.

Message Displayed: CODE 83 Inform service			
	Code 83: Throttle Potentiometer (VR1) Out-of-Neutral Throttle potentiometer (VR1) out of learned neutral value.	Test A04 - Throttle Potentiometer Voltage (Page 6-32)	Travel is disabled. Cycle key switch to clear.

Message Displayed: CODE 84 Inform service			
	Code 84: Brake Inoperable; Not Applied The drive motor bearing encoder indicated movement during Selftest.	Test O30 - Toggle Brake Solenoid (Page 6-102)	Travel disabled at startup. Make sure brake release bolts are removed from brake assembly. Cycle key switch to clear.

Message Displayed: CODE 8C Inform service			
	Code 8C: Deadman Switches Do Not Agree Deadman switches S2 and S23 do not agree or the steering encoder is disconnected.	Test I00 - Carriage Deadman (Page 6-56) Test I01 - Brake Deadman Switch (S2) (Page 6-57)	Travel, lift, lower, and brake disabled. Cycle key switch to clear.

Message Displayed: CODE 8F Inform service			
	Code 8F: Lift/Lower Potentiometer Out-of-Neutral Lift/Lower potentiometer (VR2) out of learned neutral value.	Test A05 - Lift/Lower Potentiometer Voltage (Page 6-33)	Lift and lower disabled. Cycle key switch to clear.

Message Displayed: CODE 8L Inform service			
	Code 8L: Electric Brake Feedback The VM senses the brake coil current is incorrect.	Test A35 - Brake (Page 6-46)	Travel limited to 1 mph. Cycle key switch to clear.

Message Displayed: CODE 91 Inform service			
	Code 91: Drive Unit Turned >10° while Guiding on Wire	Test I25 - Steer Motor Encoder (Page 6-69)	Truck plugs to 0 mph. Auto/Man switch to Manual. Cycle key switch to clear.

Message Displayed: CODE 92 Inform service

Icon	Code Title/Reason	Tests to Run	Notes/Corrective Action
------	-------------------	--------------	-------------------------

Message Displayed: CODE 92 Inform service

	Code 92: Tracking Limits Exceeded	<p>Test A51 - Left Tractor Guidance Coil Voltage (Page 6-49)</p> <p>Test A52 - Right Tractor Guidance Coil Voltage (Page 6-50)</p> <p>Test A53 - Left Load Guidance Coil Voltage (Page 6-51)</p> <p>Test A54 - Right Load Guidance Coil Voltage (Page 6-52)</p>	Truck plugs to 0 mph. Auto/Man switch to Manual. Cycle key switch to clear.
---	--	---	---

Message Displayed: CODE 93 Lost TCP Lost Wire

	Code 93: Not Near Wire; Tractor Coil Pair	<p>Test A51 - Left Tractor Guidance Coil Voltage (Page 6-49)</p> <p>Test A52 - Right Tractor Guidance Coil Voltage (Page 6-50)</p> <p>Test A55 - Tractor Near Wire Coil Voltage (Page 6-53)</p>	Truck plugs to 0 mph. Auto/Man switch to Manual. Cycle key switch to clear.
---	--	---	---

Message Displayed: CODE 94 Lost LCP Lost Wire

	Code 94: Not Near Wire; Load Coil Pair	<p>Test A53 - Left Load Guidance Coil Voltage (Page 6-51)</p> <p>Test A54 - Right Load Guidance Coil Voltage (Page 6-52)</p> <p>Test A56 - Load Near Wire Coil Voltage (Page 6-54)</p>	Truck plugs to 0 mph. Auto/Man switch to Manual. Cycle key switch to clear.
---	---	--	---

Message Displayed: CODE 9E Inform service

Icon	Code Title/Reason	Tests to Run	Notes/Corrective Action
Message Displayed: CODE 9E Inform service			
	Code 9E: Track And Hold Signal Failed The truck is moving on the wire and the guidance signals are not fluctuating at all.	Test A51 - Left Tractor Guidance Coil Voltage (Page 6-49) Test A52 - Right Tractor Guidance Coil Voltage (Page 6-50) Test A53 - Left Load Guidance Coil Voltage (Page 6-51) Test A54 - Right Load Guidance Coil Voltage (Page 6-52)	Truck plugs to 0 mph. Auto/Man switch to Manual. Cycle key switch OFF/ON to clear.

Message Displayed: CODE 9F Inform service

	Code 9F: Filter Card Not Connected to Guidance Manager When the auto/man switch is switched to auto and the guidance manager does not sense the filter card.	Check connection between filter card and guidance manager. Replace filter card first then guidance manager.	Hard plug to 0 mph. Cycle key switch OFF/ON to clear.
---	--	---	---

Message Displayed: CODE 9G Inform service

	Code 9G: No Input; Load Antenna The signal from the load antenna is not being received by the Guidance Manager.	Test A53 - Left Load Guidance Coil Voltage (Page 6-51) Test A54 - Right Load Guidance Coil Voltage (Page 6-52)	Truck plugs to 0 mph. Auto/Man switch to Manual. Cycle key switch OFF/ON to clear.
---	---	---	--

Message Displayed: CODE 9H Inform service

	Code 9H: No Input; Tractor Antenna The signal from the tractor antenna is not being received by the Guidance Manager.	Test A51 - Left Tractor Guidance Coil Voltage (Page 6-49) Test A52 - Right Tractor Guidance Coil Voltage (Page 6-50)	Truck plugs to 0 mph. Auto/Man switch to Manual. Cycle key switch OFF/ON to clear.
---	---	---	--

Message Displayed: CODE 9J Inform service

	Code 9J: Load Antenna Input Too High	Test A53 - Left Load Guidance Coil Voltage (Page 6-51) Test A54 - Right Load Guidance Coil Voltage (Page 6-52)	Truck plugs to 0 mph. Auto/Man switch to Manual. Cycle key switch to clear.
---	---	---	---

Message Displayed: CODE 9K Inform service

Message Displayed: CODE A0 Inform service

Icon	Code Title/Reason	Tests to Run	Notes/Corrective Action
	Code 9K: Tractor Antenna Input Too High	Test A51 - Left Tractor Guidance Coil Voltage (Page 6-49) Test A52 - Right Tractor Guidance Coil Voltage (Page 6-50)	Truck plugs to 0 mph. Auto/Man switch to Manual. Cycle key switch to clear.

Message Displayed: CODE A0 Inform service

	Code A0: Incorrect Software Incorrect VM installed in truck or Flashed with incorrect software.	None	Travel, lift, and lower disabled. Cycle key switch to clear. If this code appears, upgrade the software in the truck using Flashware.
---	---	------	---

Message Displayed: CODE A2 Inform service

	Code A2: Software Compatibility Issue with VM and TPA	None	Travel disabled. Cycle key switch to clear. If this code appears, upgrade the software in the truck using Flashware.
---	--	------	--

Message Displayed: CODE A4 Inform service

	Code A4: Software Compatibility Issue with VM and LPA AC lift only.	None	Lift disabled. Cycle key switch to clear. If this code appears, upgrade the software in the truck using Flashware.
---	---	------	--

Message Displayed: CODE AL Inform service

	Code AL: VM Battery Backed Up RAM Failed	None	Travel, lift, and lower disabled. Cycle key switch to clear. If code will not clear, replace VM.
---	---	------	--

Message Displayed: CODE AP Inform service

	Code AP: TPA Software Fault	None	Travel disabled. Cycle key switch to clear. If code will not clear, Flash traction power amplifier with latest software.
---	------------------------------------	------	--

Message Displayed: CODE AT Inform service

Message Displayed: CODE FE Inform service

Icon	Code Title/Reason	Tests to Run	Notes/Corrective Action
	Code AT: LPA Software Fault AC lift only.	None	Lift disabled. Cycle key switch to clear. If code will not clear, Flash lift power amplifier with latest software.

Message Displayed: CODE FE Inform service

	Code FE: Internal VM Circuit for BSOC Not Calibrated	None	Code is displayed for 30 seconds. Replace VM.
---	---	------	---

Message Displayed: CODE FG Inform service

	Code FG: +5V Reference Voltage and +12V Power Supply Failure	Test A14 - VM +12V Power Supply (Page 6-39)	Travel, lift, and lower disabled. Brake will engage. Cycle key switch to clear.
---	---	---	---

Message Displayed: CODE FH Inform service

	Code FH: Battery Voltage Out-of-Range Wrong voltage battery or voltage out-of-range.	Test A15 - Battery Voltage (Page 6-40)	Travel, lift, and lower disabled. Brake will remain engaged. Cycle key switch to clear.
---	--	--	---

Message Displayed: CODE FN Inform service

	Code FN: Relays Did Not Open at Power Off	Test O32 - Toggle Relays (Page 6-103)	Travel, lift, and lower disabled. Brake will engage. Cycle key switch to clear.
---	--	---------------------------------------	---

Message Displayed: CODE FP Inform service

	Code FP: VM In-Circuit Hardware Failure	None	Travel, lift, and lower disabled. Brake will remain engaged. Cycle key switch to clear. Replace VM.
---	--	------	---

Message Displayed: CODE FT Inform service

Message Displayed: CODE G0 Inform service

Icon	Code Title/Reason	Tests to Run	Notes/Corrective Action
	Code FT: VM Internal Software Error	None	Travel, lift, and lower disabled. Brake will remain engaged. Cycle key switch to clear. If code will not clear, Flash VM with latest software.

Message Displayed: CODE G0 Inform service

	Code G0: Steer Tiller Encoder 1 is Intermittent or Failed Determined by channel A and/or B not functioning correctly when compared with Steer Tiller Encoder 2.	Test I35 - Steer Tiller Encoder 1 (Page 6-71)	Coasts to 2.5 mph. Travel limited to 2.5 mph. Cycle key switch to clear.
---	---	---	--

Message Displayed: CODE G2 Inform service

	Code G2: Auto Steer Center Failed 1. Home switch is more than 10 degrees from the initial value saved during a successful auto steer center. 2. Auto steer center time-out - greater than 2 seconds. 3. No encoder pulses sensed during auto steer center.	See "Auto Steer Center Problem" on page 5-31.	Moderate plug to 0.0 mph. Step off then back on the deadman pedal to allow travel again. Max travel speed limited to 1.0 mph. Cycle key switch OFF/ON to clear.
---	---	---	---

Message Displayed: CODE G3 Inform service

	Code G3: Home Prox Switch Not Functioning Correctly	See "Auto Steer Center Problem" on page 5-31.	All steer indicator lights will flash. Travel speed limited to 1.0 mph. Cycle key switch OFF/ON to clear.
---	--	---	---

Message Displayed: CODE G4 Inform service

	Code G4: Open Detected in Steer Control Circuit No neutral pulses detected when the truck is not moving and operator is on the deadman pedal.	See "Auto Steer Center Problem" on page 5-31.	Aggressive plug to 0.0 mph. Step off then back on the deadman pedal to allow travel again. Max travel speed set to 1.0 mph. Cycle key switch OFF/ON to clear.
---	---	---	---

Message Displayed: CODE G5 Inform service

Icon	Code Title/Reason	Tests to Run	Notes/Corrective Action
Message Displayed: CODE G5 Inform service			
	Code G5: Short Detected in Steer Power Circuit Steer motor encoder pulses or command detected and no steer tiller encoder pulses detected.	Test A37 - Steer Power Amplifier Current (Page 6-47) Test I25 - Steer Motor Encoder (Page 6-69)	Moderate plug to 0.0 mph. Step off then back on the deadman pedal to allow travel again. Max travel speed set to 1.0 mph. Cycle key switch OFF/ON to clear.

Message Displayed: CODE G7 Inform service			
	Code G7: Steer Tiller Encoder 2 is Intermittent or Failed Determined by the connect detect circuit for the CD Supply and Gnd connections or by channel A and/or B not functioning correctly when compared with Steer Tiller Encoder 1.	Test I36 - Steer Tiller Encoder 2 (Page 6-72)	Coasts to 2.5 mph. Travel limited to 2.5 mph. Cycle key switch to clear.

Message Displayed: CODE GD Inform service			
	Code GD: No Steer Motor Encoder Pulses Seen No steer motor encoder pulses seen when requesting a steer correction, travel is >0.1 mph or during auto steer center.	Test I25 - Steer Motor Encoder (Page 6-69)	Truck plugs to 0 mph. Travel limited to 1 mph. More steer tiller rotations required to turn drive unit. Cycle key switch to clear.

Message Displayed: CODE GE Inform service			
	Code GE: Both Steer Tiller Encoders Failed Determined by the connect detect circuit.	Test I35 - Steer Tiller Encoder 1 (Page 6-71) Test I36 - Steer Tiller Encoder 2 (Page 6-72)	Truck plugs to 0 mph. Travel limited to 1 mph. Cycle key switch to clear.

Message Displayed: CODE J2 Inform service			
	Code J2: Aisle Exit Error Only one magnet was sensed when the guided aisle was exited.	Test I72 - End-of-Aisle Sensor 2 (optional) (Page 6-84) Test I73 - End-of-Aisle Sensor 1 (optional) (Page 6-86)	Plugs to stop, speed is limited to 1 mph. While out of the aisle, switch the AUTO/MAN switch to manual. Turn the drive unit >10° and travel until the code clears.

Message Displayed: CODE J4 Inform service			
--	--	--	--



Message Displayed: CODE X3 Inform service

Icon	Code Title/Reason	Tests to Run	Notes/Corrective Action
	Code J4: Aisle Sensor Error	Test I72 - End-of-Aisle Sensor 2 (optional) (Page 6-84) Test I73 - End-of-Aisle Sensor 1 (optional) (Page 6-86)	Travel limited to 1 mph.

Message Displayed: CODE X3 Inform service

	Code X3: 180 in. Limit Switch Mismatch The 180 in. Switch (S100) is out of sequence with a standard mast switch.	Test I75 - 180 in. Limit Switch (optional) (Page 6-89)	Travel limited to 1.0 mph. Cycle key switch OFF/ON to clear.
--	--	---	---

Message Displayed: CODE X4 Inform service

 	Code X4: Lift Cutout Switch Mismatch Lift Cutout Switch (S124) mismatch with standard mast switch.	Test I76 - Lift Cutout Switch (optional) (Page 6-90)	Cycle key switch OFF/ON to clear. <i>Up arrow icon flashes and message lift cutout - max ht reached</i>
--	--	---	--

Message Displayed: CODE X5 Inform service

	Code X5: Lift Inhibit Switch Mismatch Lift Inhibit Switch (S24) mismatch with standard mast switch.	Test I05 - Lift Inhibit Switch (optional) (Page 6-62)	Cycle key switch OFF/ON to clear.
---	---	--	-----------------------------------

Test A20 - Lift Motor Current (AC lift only)

Test A20 - Lift Motor Current (AC lift only)

This test displays the lift motor current through the lift power amplifier.



The lift carriage and forks will move during this test.



The area around the forks must be clear. The ceiling clearance should allow for the highest lift.

Limits

- 0 to 500A lifting
- Maximum current 675A

For information on using Maintenance Mode, refer to page 3-24.

Run test:

The Operator Display shows the current that the lift power amplifier reads from one phase of the lift motor.

NOTE: Because only one phase is measured, a current problem may not be revealed.

Diagnosis and Repair

NOTE: Check all motor and power amplifier connections for tightness and corrosion.

Check individual phase currents with a clamping ammeter. The current should ramp evenly as the truck accelerates and decelerates. Phase currents must be approximately equal. Gross differences indicate a problem.

If readings are not within reference limits, the test has failed.

1. If any one phase differs significantly from the other two, check power cable continuity. Replace cables as necessary. See Terminal Hardware on page 7-66.

- If power cable continuity is OK, troubleshoot the drive motor. See AC Motor Troubleshooting on page 5-10.
 - If all phases give high readings, the lift pump may be binding.
2. The power amplifier may be bad. Run Test O28 - Ramp Lift Motor (AC lift only) (Page 6-100).

Test A22 - Traction Throttle Request

This test displays the percentage of traction throttle request from VR1 being read by the VM.

For information on using Maintenance Mode, refer to page 3-24.

Run test:

NOTE: Run Learn after you replace, repair, or adjust the throttle assembly. See Learn Controls on page 3-19.

The Operator Display shows the percentage of throttle request that the VM reads from the control handle throttle potentiometer (VR1) and sends to the traction power amplifier.

Acceptable values are:

Throttle Position	Percentage Displayed
Full Tractor-First	0 to +100
Neutral	0
Full Forks-First	0 to -100

The values must change smoothly and evenly as the handle moves from full tractor-first to full forks-first.

If percentages are not within reference limits, the test has failed.

NOTE: Any speed limiting conditions will result in less than 100 shown on display.

Diagnosis and Repair

Step	Action/ Meter Setting	(+) Lead	(-) Lead	Expected Results	Step Passed	Step Failed
1	Run Test A04 - Throttle Potentiometer Voltage (Page 6-32)	N/A	N/A	Test should pass. Compare Test A04 results with the results from A22. Max throw should show max values.	Replace the TPA	Check traction system for speed limits due to motor temperature, limit switches, or configured speed.

Test A23 - Lift Request

Test A23 - Lift Request

This test displays the percentage of lift throttle request from VR2 being read by the VM.

For information on using Maintenance Mode, refer to page 3-24.

Run test:

NOTE: Run the Learn after you replace, repair, or adjust the lift/lower potentiometer (VR2). See Learn Controls on page 3-19.

The Operator Display shows the percentage of lift request that the VM reads from the lift potentiometer (VR2).

Acceptable values are:

Throttle Position	Percentage Displayed
Full Lower	0 to -100
Neutral	0
Full Lift	0 to +100

The values must change smoothly and evenly as the handle moves from full lower to full lift.

If percentages are not within reference limits, the test has failed.

NOTE: Any lift limiting conditions will result in less than 100% shown on display.

Diagnosis and Repair

Step	Action/ Meter Setting	(+) Lead	(-) Lead	Expected Results	Step Passed	Step Failed
1	Run Test A05 - Lift/Lower Potentiometer Voltage (Page 6-33)	N/A	N/A	Test should pass. Compare Test A05 results with the results from A23. Max throw should show max values.	Replace the LPA	Check lift system for limits due to motor temperature or switches.

Test A34 - Lift/Lower Current

This test displays the current the proportional lift/lower solenoid coil is drawing.

For information on using Maintenance Mode, refer to page 3-24.

Run test:

Acceptable values are:

State	Current
Neutral	Approx. 0.15A
Full Lower	Approx. 1.3A

If results do not match the preceding table, the test has failed.

Diagnosis and Repair

Step	Action/ Meter Setting	(+) Lead	(-) Lead	Expected Results	Step Passed	Step Failed
1	JPT18 and JPF2 disconnected/ Ohms	JPF2-5	JPC18-1	Approx 28 ohms	Perform Step 2	T/S wires and coil
2	DCV	JPT18-1	B-	B+	Replace VM	T/S Fuse Relay Card

Test A35 - Brake

Test A35 - Brake

The brake coil is activated by a coil driver located inside the Vehicle Manager. This test displays the voltage measured across that coil driver.

For information on using Maintenance Mode, refer to page 3-24.

NOTE: This test can only be run in Active Maintenance.

Run test:

When the test is run, observe the following results:

State of Brake	Display
Brake deactivated	B+
Deadman Pedal Depressed/Travel Requested	Approx. 12V (36V trucks) Approx. 0V (24V trucks)

If results do not match the preceding table, the test has failed.

Diagnosis and Repair

Step	Action/ Meter Setting	(+) Lead	(-) Lead	Expected Results	Step Passed	Step Failed
1	JPT20 and JPF2 disconnected/ Ohms	JT20-14	JF2-2	Approx. 13 ohms	Perform Step 2	T/S wires and coil
2	DCV	JP20-14	TP4	Brake de-energized: B+ Brake energized: 36V truck = approx. 12V 24V truck = 0V	Inspect brake assembly for binding	If no B+, T/S Fuse Relay Card. If voltage does not drop when energized, replace VM

Test A37 - Steer Power Amplifier Current

This test displays the current that the steer motor is drawing.

For information on using Maintenance Mode, refer to page 3-24.

Run Test:

You should see:

State of Motor	Display
At rest	<2A
Clockwise (CW) Steering	-30 to -50A
Counterclockwise (CCW) Steering	30 to 50A
NOTE: CW and CCW is drive unit direction.	

If the results do not match the preceding table, the test has failed.

Diagnosis and Repair

Step	Action/ Meter Setting	(+) Lead	(-) Lead	Expected Results	Step Passed	Step Failed
1	DCV	JPT6-3	TP4	at rest: approx. 2.5V Steering CCW: <V at rest Steering CW: >V at rest	Replace VM	Replace Steer Amplifier

Test O18 - Toggle Horn

Test O18 - Toggle Horn

This test toggles the horn ON and OFF.

For information on how to use Maintenance Mode, refer to page 3-24.

Run test:

The horn should sound when test is activated.
If these results are not observed, the test has failed.

Diagnosis and Repair

Step	Action/ Meter Setting	(+) Lead	(-) Lead	Expected Results	Step Passed	Step Failed
1	DCV	H2	TP4	B+	Perform Step 2	T/S wires and Fuse Relay Card
2		TP1	H1	Horn OFF: <0.5V Horn ON: B+	Replace horn	Perform Step 3
3			JPT18-16		T/S wires to horn	Replace VM

Test O19 - Audible Alarm

Using this test, the operation of the audible alarm in the CCC can be verified.

A successful test proves the audible alarm is functioning.

For information on how to use Maintenance Mode, refer to page 3-24.

Run test:

Alarm	Operator Display
Sounding	Ramp
OFF	Off

This test will generate a sound on the audible alarm in the CCC.

If these results are not observed, the test has failed.

Diagnosis and Repair

Replace Carriage Control Card.

Test O20 - Travel Alarm (optional)

Test O20 - Travel Alarm (optional)

This test verifies the operation of the travel alarm.

A successful test proves the wiring and related circuitry in the VM are functioning correctly.

For information on how to use Maintenance Mode, refer to 3-24.

NOTE: In order to test the output portion of the Vehicle Manager, a device that will cause a load in the circuit is required. The load holding coil on the hydraulic manifold can be used for testing purposes. Remove the load holding coil and carefully connect wires into the circuit. Use extreme caution and make sure that the wires do not short to any components.

Run test:

Connect a voltmeter at JPT20-17 wrt JPT18-18.

Voltage Output	Operator Display
0.0 to 1.0V	Off
22.0V	On

When the display shows ON, the optional device must be activated.

If these results are not observed, the test has failed.

Diagnosis and Repair

Step	Action/ Meter Setting	(+) Lead	(-) Lead	Expected Results	Step Passed	Step Failed
1	DCV	AL+	AL-	Approx. 22V	Replace alarm	Perform Step 2
2				B+	Perform Step 3	Test wire to AL+
3		JPT18-18	TP4	24V truck: approx. 2V 36V truck: approx. 14V	Repair/replace wire to AL-	Replace VM
4	Connect Load Holding Coil/DCV	JPT20-17	JPT18-18	Approx. 22V	Replace alarm	Replace VM

Test O25 - Toggle 2 Stage Select Solenoid (optional)

Test O25 - Toggle 2 Stage Select Solenoid (optional)

This test toggles the solenoid OFF and ON, verifying its correct operation electrically.

NOTE: This test does *not* prove that the solenoid valve is mechanically functional.

A successful test proves that the solenoid coil, coil driver, wiring and related circuitry in the VM are functioning correctly.

For information on how to use Maintenance Mode, refer to page 3-24.

Run test:

1. Turn the key switch OFF and disconnect the battery connector.
2. Disconnect the wire from the solenoid coil at SOL-1.
3. Connect a digital ammeter in series with the solenoid: (-) lead to SOL-1, (+) lead to the wire removed from SOL-1.

Diagnosis and Repair

Step	Action/ Meter Setting	(+) Lead	(-) Lead	Expected Results	Step Passed	Step Failed
1	JPT18 and JPF2 disconnected/ Ohms	JPF2-5	JPC18-1	Approx 28 ohms	Perform Step 2	T/S wires and coil
2	DCV	JPT18-1	B-	B+	Replace VM	T/S Fuse Relay Card

4. Reconnect the battery connector and turn the key switch ON. Run test and observe the following results.

Ammeter Reading	Operator Display
0.0 to 0.02A	Off
1.0 to 2.0A	On

If the above results are not observed, the test has failed.

5. Turn the key switch OFF and disconnect the battery connector. Remove the ammeter from the circuit and reconnect the wire.

Test O28 - Ramp Lift Motor (AC lift only)

Test O28 - Ramp Lift Motor (AC lift only)

This test ramps the lift motor by gradually increasing the command to the lift power amplifier via the CAN bus. This test verifies that the lift power amplifier can drive the lift motor.

⚠ CAUTION

Running this test for an extended period of time can cause damage the motor, power amplifier, or wiring.

⚠ WARNING

Open the emergency lowering valve before performing this test. See "Emergency Lower Valve" on page 2-9.

For information on how to use Maintenance Mode, refer to page 3-24.

Diagnosis and Repair

Step	Action/ Meter Setting	(+) Lead	(-) Lead	Expected Results	Step Passed	Step Failed
1	Current probe (amp clamp) on phases U, V, and W	N/A	N/A	Current must be even on all phases and ramp up as the percentage increases.	Replace Lift Amplifier	If current does not ramp to one or two phases, test cables to motor. If OK, replace motor. If phases are low or unequal, replace the Lift Amplifier. If phases are equal and high but motor runs slow, check for binding. If not binding, replace lift motor.

Run test:

The requested rpm is displayed. Use the Up (▲) button to increase the rpm in increments of 25, from a minimum of 775 rpm to a maximum of 1500 rpm.

NOTE: To prevent lift pump damage due to very low rpm, the minimum lift motor speed request is 775 rpm.

When the maximum requested rpm is reached, press Down (▼) to reset the request to 0. Press the Enter (↵) button to exit the test.

Test O29 - Ramp Traction Motor

This test ramps the traction motor by gradually increasing the command to the traction power amplifier via the CAN bus. This test verifies that the traction power amplifier can generate current and drive the traction motor.

CAUTION

Running this test for an extended period of time can cause damage to the traction motor, power amplifier, or wiring.

WARNING

The traction motor will rotate during this test. Jack the drive wheel off the floor. Use extreme care whenever the truck is jacked up for any reason. Never block the truck between the telescopic and the floor. Use a suitable hoist to stabilize the mast. Keep hands and feet clear from beneath vehicle while jacking. Use jack stands or solid blocks to support truck. DO NOT rely on the jack alone. See Jacking on page 2-8.

For information on how to use Maintenance Mode, refer to page 3-24.

Run test:

Step on the deadman pedal and run test.

The requested rpm is displayed. Use the Up (▲) button to increase the rpm in increments of 25, from 0 to a maximum of 1500 rpm.

When the maximum requested rpm is reached, press Down (▼) to reset the request to 0. Press the Enter (↵) button to exit the test.

Diagnosis and Repair

Step	Action/ Meter Setting	(+) Lead	(-) Lead	Expected Results	Step Passed	Step Failed
1	Current probe (amp clamp) on phases U, V, and W	N/A	N/A	Current must be even on all phases and ramp up as the percentage increases.	Replace Traction Amplifier	If current does not ramp to one or two phases, test cables to motor. If OK, replace motor. If phases are low or unequal, replace the Traction Amplifier. If phases are equal and high but motor runs slow, check for binding. If not binding, replace drive motor.

Test O43 - Aux Load Hold Solenoid (optional)

Test O43 - Aux Load Hold Solenoid (optional)

This test toggles the Aux Load Hold Solenoid OFF and ON, verifying its correct operation electrically.

A successful test proves that the Aux Load Hold Solenoid coil, coil driver, wiring, and related circuitry in the VM are functioning correctly.

NOTE: This test does *not* prove that the Aux Load Hold Solenoid valve is mechanically functional.

For information on how to use Maintenance Mode, refer to page 3-24.

Run test:

1. Turn the key switch OFF and disconnect the battery connector.
2. Disconnect the wire from the Aux Load Hold Solenoid coil at AUX L/H SOL-X.
3. Connect a digital ammeter in series with the Aux Load Hold Solenoid: (-) lead to AUX L/H SOL-X terminal, (+) lead to the removed wire.

4. Reconnect the battery connector and turn the key switch ON. Run test and observe the following results.

Ammeter Reading	Operator Display
0.0 to 0.02A	Off
1.0 to 2.0A	On

If the above results are not observed, the test has failed.

5. Turn the key switch OFF and disconnect the battery connector. Remove the ammeter from the circuit and reconnect the wire.

Diagnosis and Repair TBD

Step	Action/ Meter Setting	(+) Lead	(-) Lead	Expected Results	Step Passed	Step Failed
1	JPT18 and JPF2 disconnected /Ohms	JPT18-12	JPF2-3	Approx. 38 ohms	Perform Step 2	T/S wires and coil
2	DCV	JPF2-3	TP4	B+	Replace VM	T/S relays and Fuse Relay Card

Section 7. Component Procedures

Component Locator Photos	7-3	Spiral pinion gear shim calculation:	7-31
Steering and Controls	7-9	Bevel gear shim calculation:	7-32
Steer Motor/Gearbox	7-10	Housing Bearing Cup and Shim Assembly	7-33
Encoder Bearing Replacement	7-10	7-33
Home Proximity Sensor Adjustment	7-11	Helical Gear/Spiral Pinion Gear Assembly	7-34
Control Handle.	7-12	7-34
Removal.	7-12	Axle Assembly	7-35
Disassembly	7-12	Measuring Backlash.	7-37
Lift/Lower Potentiometer and Spring Re-		Pivot Ring Assembly	7-38
placement	7-13	Drive Unit Assembly.	7-39
Horn Switch Replacement	7-13	Housing Cover Installation	7-41
Assembly	7-13	Drive Unit - Heavy Duty.	7-42
Travel Pot (VR1) Replacement	7-14	Pivot Ring Inspection	7-42
Travel Spring and Pinion	7-15	Drive Unit Removal.	7-42
Disassembly	7-15	Pivot Ring Disassembly	7-43
Assembly	7-15	Main Cover and Output Shaft Disassembly	7-44
Lift/Lower Knob Installation/Adjustment		7-44
.	7-16	Spiral Pinion Disassembly.	7-45
Cleaning and Inspection	7-16	Assembly Procedures	7-46
Hand Soldering Procedures	7-17	Spiral Pinion Assembly.	7-46
Installation	7-17	Main Cover and Output Shaft Assembly	7-47
Deadman Pedal	7-18	7-47
Switch Replacement.	7-18	Helical Gear Assembly.	7-49
Trucks S/N 00100 thru 00133	7-18	Calculate Shim Formulas	7-49
Trucks S/N 00134 and Higher	7-18	Installing and Testing Shims	7-50
Emergency Power Off Switch	7-20	Measuring Backlash.	7-51
Removal.	7-20	Main Cover Installation	7-51
Installation	7-20	Pivot Ring Assembly	7-51
Drive and Brake.	7-21	Radial Ring Inspection	7-53
Drive Motor	7-22	Brake	7-54
Removal/Installation	7-22	Brake Adjustment.	7-54
Drive Unit - Standard.	7-23	Brake Rotor Replacement	7-55
Pivot Ring Inspection	7-23	Removal/Disassembly	7-55
Drive Unit Removal	7-23	Assembly/Installation	7-55
Pivot Ring Disassembly	7-24	Drive Wheel.	7-58
Drive Unit Housing Disassembly	7-25	Removal	7-58
Radial Ring Removal	7-26	Installation	7-58
Axle Shaft and Bevel Gear Removal	7-26	Drive Tire Replacement	7-58
Spiral Gear and Helical Gear Removal	7-27	Electrical Components	7-61
Bearing Cup and Shim Removal	7-28	Battery Procedures	7-62
Spur Gear Removal	7-29	Battery Connector/Cables.	7-62
Housing Cleaning and Inspection	7-29	Battery Exterior Cleaning	7-62
Axle Shaft Disassembly	7-29	Testing, Charging, and Maintenance	7-63
Bevel Gear Disassembly	7-30	Motors.	7-64
Spiral Gear Disassembly	7-30	DC Motor Brushes	7-64
Assembly Procedures	7-31	Inspection	7-64
Gear Set Assembly	7-31	Replacement.	7-64
Calculate Shim Formulas	7-31	DC Motor Brush Spring Tension	7-65
		Inspection	7-65

DC Motor Commutator	7-66	Forks	7-95
Inspection.	7-66	Removal	7-95
Terminal Hardware	7-66	Installation	7-95
AC Motor Service	7-68	Mast Bearing Shimming	7-96
AC Motor Temperature Sensor.	7-68	Mast Disassembly and Shimming.	7-98
Drive Motor Replacement:	7-68	Shimming Main Frame to Outer	
Lift Motor Replacement:	7-68	Telescopic	7-98
AC Motor Bearing Encoder	7-69	Shimming Outer Telescopic to Inner	
Drive Motor Replacement:	7-69	Telescopic	7-99
Lift Motor Replacement:	7-70	Shimming Inner Telescopic to Carriage	
Power Amplifiers	7-71	7-100
Removal	7-71		
Installation	7-71		
Carriage Control Card Replacement	7-72		
EPRoM/Microprocessor Removal/Replacement			
.	7-73		
Removal	7-73		
Installation	7-73		
Hydraulic Components	7-75		
Flow Sensor Service Notes	7-76		
O-Ring Replacement	7-76		
Disassembly	7-77		
Assembly.	7-78		
High Pressure Relief Valve Adjustment.	7-79		
Lift/Lower and Load Holding Valves.	7-80		
Bleeding Lift Cylinders	7-81		
Side Lift Cylinders.	7-81		
Center Cylinder.	7-81		
Lift Pump and Motor	7-82		
Removal	7-82		
Installation	7-82		
Pressure Switch Adjustment	7-83		
Side Lift Cylinder.	7-84		
Remove	7-84		
Installation	7-84		
Cushion Service	7-85		
Cleaning	7-86		
Seal Repacking	7-86		
Center Lift Cylinder	7-88		
Removal	7-88		
Installation	7-88		
Service of Cylinder with Cushions	7-88		
Cushion Replacement	7-88		
Seal Replacement	7-89		
Installation	7-89		
Mast Section.	7-91		
Carriage.	7-92		
Removal	7-92		
Installation	7-93		
Center Cylinder Ride Spring Chain Anchors			
.	7-94		
Inspection.	7-94		

Component Locator Photos

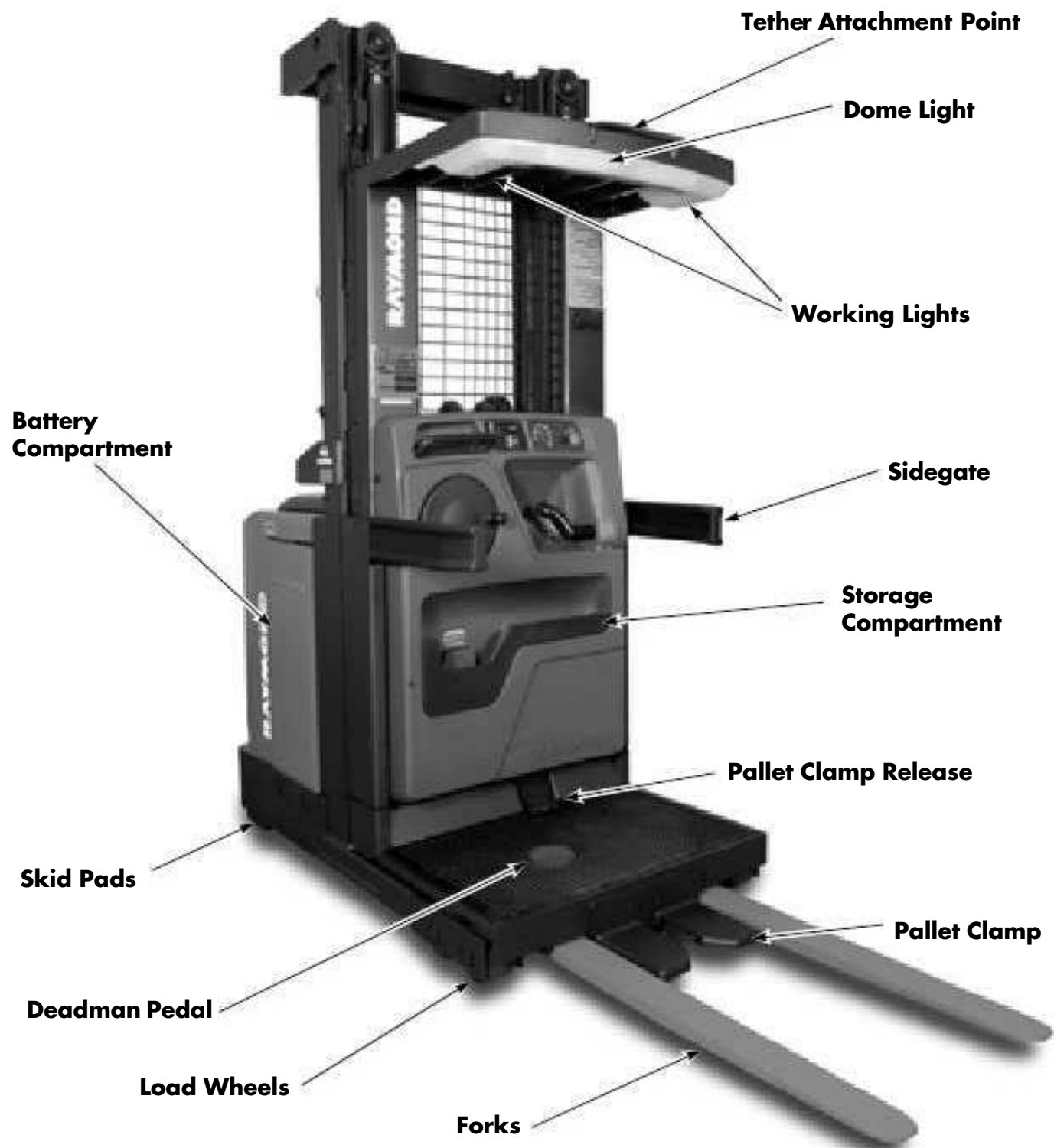

Figure 7-1. Model 5600 - Overall View

78C04050S.TIF

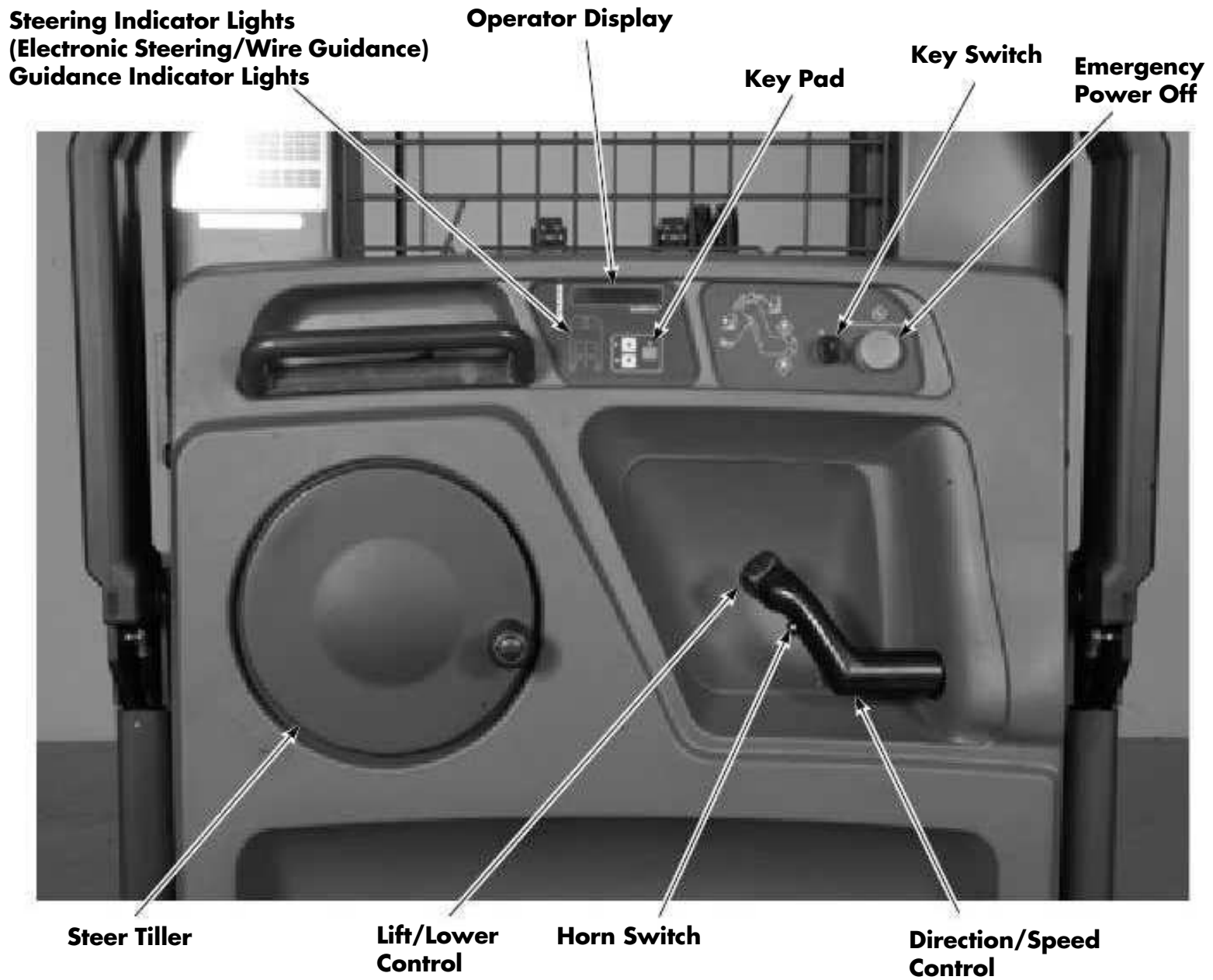

Figure 7-2. Operator Console

78C11036H.TIF

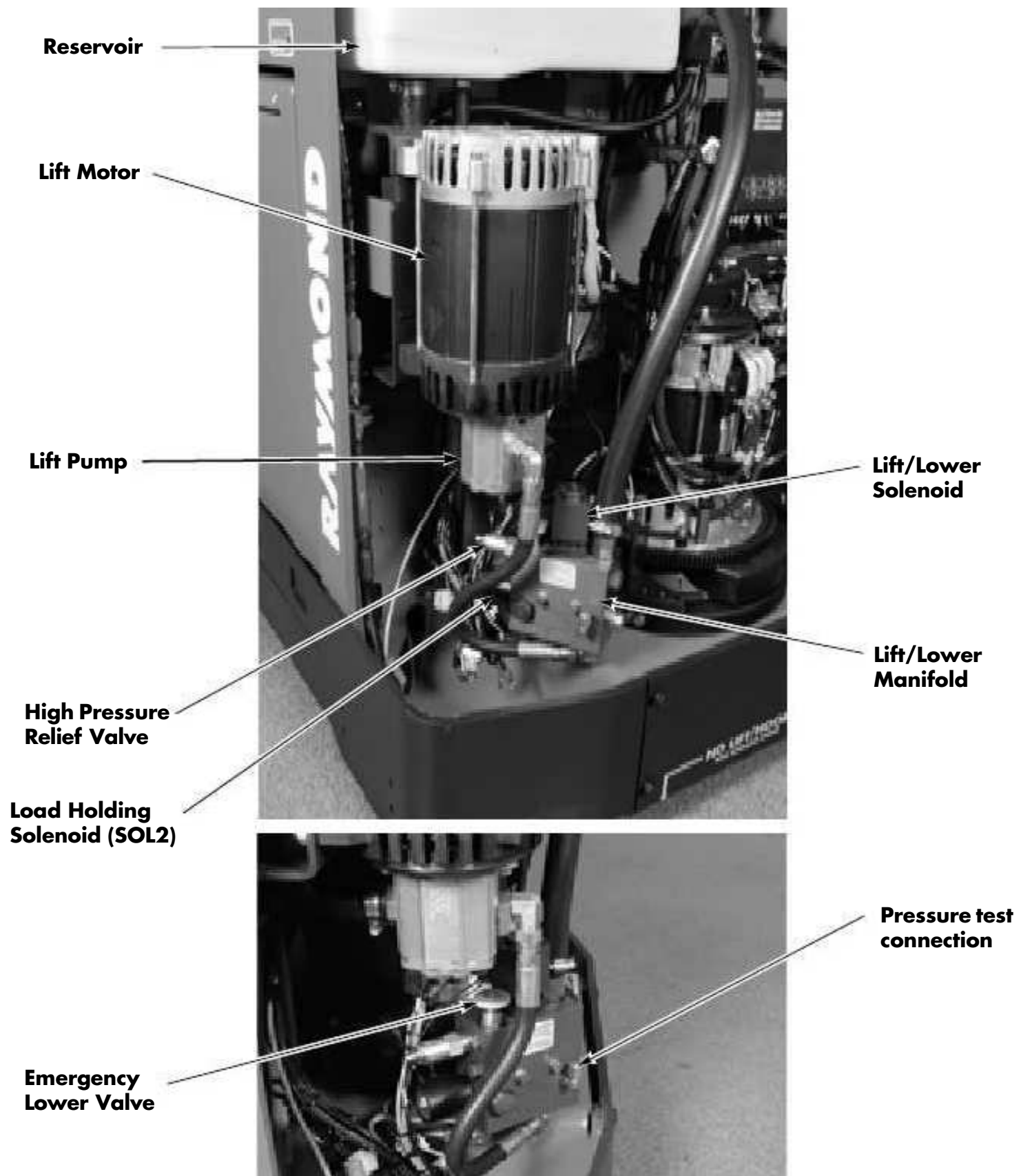

Figure 7-3. Hydraulic Compartment Components

7

Section 7. Component Procedures **Steering and Controls**

Steer Motor/Gearbox

Encoder Bearing Replacement

NOTE: Replace the shaft seal, the B side bearing, and the brushes while the motor is apart.

1. Turn the key switch OFF and disconnect the battery connector.
2. Remove the steer motor/gearbox.
3. Remove the B side end bell and brush retainers. See Figure 7-7.
4. Remove the A side end bell bolts and pull the end bell and rotor from the motor housing. Push the wires and rubber grommet out of the housing slot.
5. Loosen the two phillips head screws that are used with the small clips to retain the bearing in the A side end bell.
6. Remove the A side end bell from the rotor.
7. Use a press to remove the old bearing.

CAUTION

New encoder bearings are mounted like regular bearings except induction heaters must not be used because they demagnetize the encoder. Also, care must be taken against ESD. See page 2-7.

NOTE: When pressing a bearing onto a shaft, press on the inner race, never the outer race.

8. Press on the new bearing and reassemble the motor, Place a small amount of good quality grease between the new bearing and the shaft seal. Take care to not damage the pinion gear in the end of the motor shaft.

9. Torque the bolts holding the motor to the gear reducer to approximately 85 in. lbs. (9.9 N•m).



Figure 7-7. Steer Motor and Gearbox

7

Home Proximity Sensor Adjustment

1. Turn the key switch OFF and disconnect the battery connector.
2. Loosen the two lock nuts securing the sensor to the bracket. See Figure 7-8.

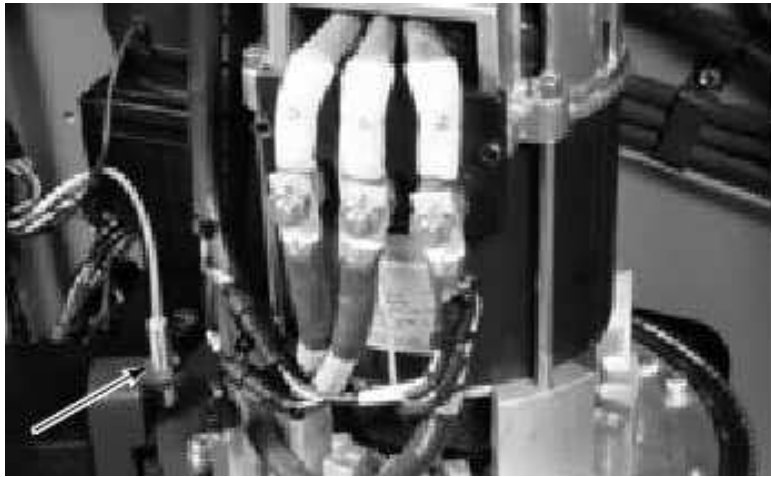

Figure 7-8. Home Proximity Sensor

3. Adjust the vertical gap between the sensor and the sensor rail to $0.060 +0.010 / -0.040$ in. ($1.5 +0.254 / -1.016$ mm). Tighten the lock nuts.
4. Reconnect the battery connector and turn the key switch ON.
5. Center the drive wheel. The sensor must be located horizontally just over the end of the sensor rail.

Control Handle

Removal

1. Turn the key switch OFF and disconnect the battery connector.
2. Disconnect JPC9 and remove the Control Handle from the truck.

NOTE: Observe orientation of switches/potentiometers (pot) and routing of cables/wires as the handle is disassembled to make reassembly easier.

CAUTION

Observe correct ESD precautions. See Electrostatic Discharge Precautions on page 2-7.

Before disassembly, determine what components require replacement:

- Lift/Lower Pot, Spring, and/or Horn Switch
- Travel Pot
- Travel Spring and/or Pinion
- Lift/Lower Knob

Disassembly

1. Remove the two 3/32 socket head nylon set screws in the lift/lower knob (thumb lever). If stripped, use a small 1/8 in. (3.2mm) blade flat screwdriver and carefully back out the set screw.
2. Loosen the two metal set screws in the lift/lower knob two full turns and remove the lift/lower knob.

NOTE: Carefully slide the two fiber washers, lift/lower spring, and third fiber washer off of the lift pot shaft. See Figure 7-9.



Figure 7-9. Spacer Washer and L/L Spring Removal

3. Remove the three 3 mm socket head cap screws from the handle assembly. See Figures 7-10 and 7-11. Separate the cover from the handle.



Figure 7-10. Cover Retaining Screws - Bottom



Figure 7-11. Cover Retaining Screw - Top

Lift/Lower Potentiometer and Spring Replacement

NOTE: Before sliding the potentiometer (pot) bracket off the pot shaft, identify what slot in the pot bracket is used to hold the pot anti-rotate tab. The anti-rotate tab must be located in the slot furthest from the pin in the pot bracket.

1. Remove the lift/lower pot and bracket from the cover. See Figure 7-12.

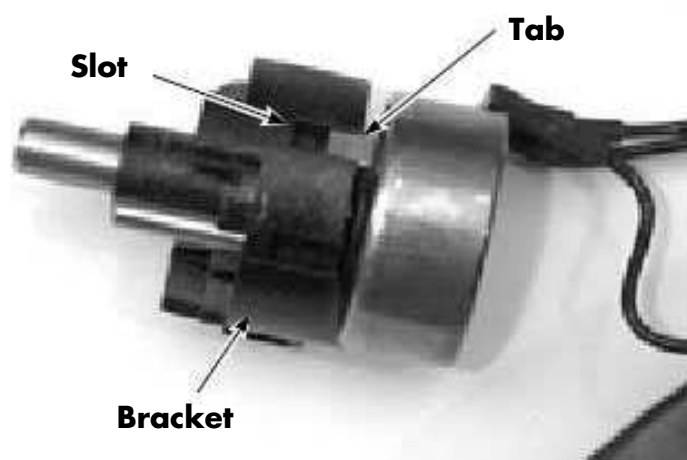

Figure 7-12. Anti-Rotate Tab

NOTE: The button, pin, and spring can easily slide apart. Identify the correct position of these components before disassembly.

2. If replacing the pot, carefully remove heat shrink tubing from the terminals. Identify the wires so they can be installed in the same location on the new pot.
3. Carefully unsolder the harness wires from the lift/lower pot.
4. Carefully solder harness wires to the correct terminals on the new lift/lower pot. Refer to Hand Soldering Procedures on page 7-17.
5. Slide lift/lower pot bracket onto the shaft. Make sure the anti-rotation tab is inserted into the correct slot on the bracket. See Figure 7-12.
6. Press the lift/lower pot and bracket into the handle cover. Make sure the key on the bracket engages the keyway in the handle cover.

Horn Switch Replacement

1. Disconnect the horn switch connector. See Figure 7-13.

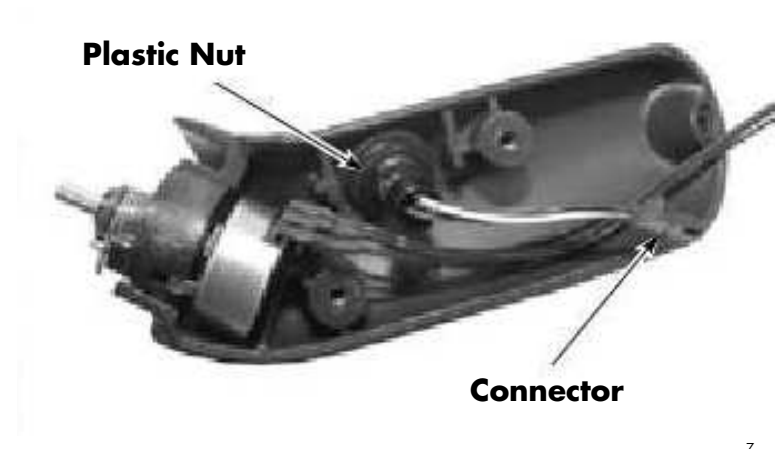

Figure 7-13. Horn Switch Removal

2. Remove plastic nut and internal tooth washer securing horn switch.
3. Install new horn switch assembly into the handle cover. Install internal tooth washer and plastic nut.

Assembly

1. Make sure all wires are routed correctly. Tuck the common ground wire into handle between the bottom of the potentiometer and the screw boss to prevent the wire from being pinched or interfering with the horn button.
2. Install the cover onto the handle assembly with the three socket head cap screws. Torque to 15-20 in. lb. (1.7-2.25 N•m).
3. Install a fiber washer and lift/lower spring (lightly greased with P/N 990-635) on the lift/lower pot shaft. Install the spring with the tangs straddling the pot bracket pin. See Figure 7-9.

NOTE: Replace the spring if the tangs are not parallel. *Do not* bend the spring.

4. Install the two remaining fiber washers.
5. Install the lift/lower knob. See “Lift/Lower Knob Installation/Adjustment” on page 7-16.

Travel Pot (VR1) Replacement

1. Remove the four hex head cap screws from the front of the travel pot enclosure and remove cover. See Figure 7-14.

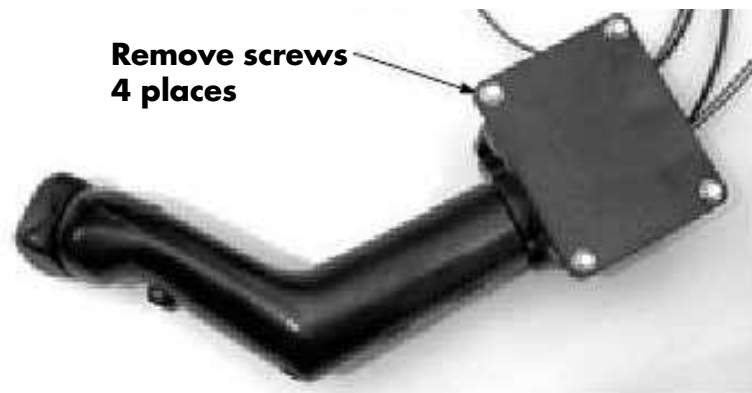

Figure 7-14. Travel Pot Cover Removal

2. Remove the two pan head machine screws from the back of the enclosure. Carefully pull the travel pot/bracket assembly from the enclosure. See Figures 7-15 and 7-16.



Figure 7-15. Travel Pot Bracket Screws

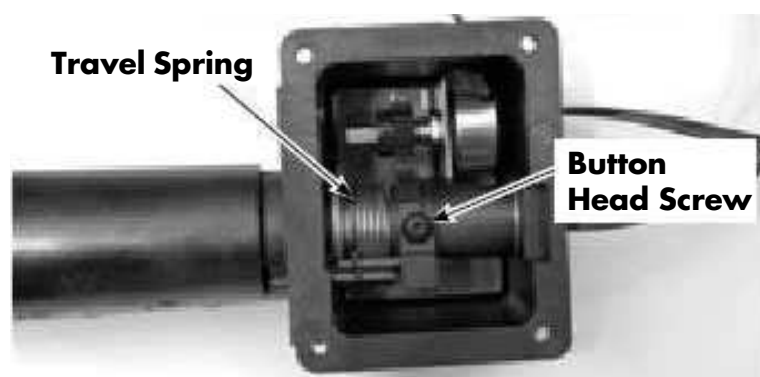

Figure 7-16. Travel Pot Enclosure (Cover Removed)

3. Loosen the set screw on the gear two full turns and slide the gear off the shaft. See Figure 7-17.
4. Remove retaining nut and lock washer from pot and separate from the bracket. See Figure 7-17.

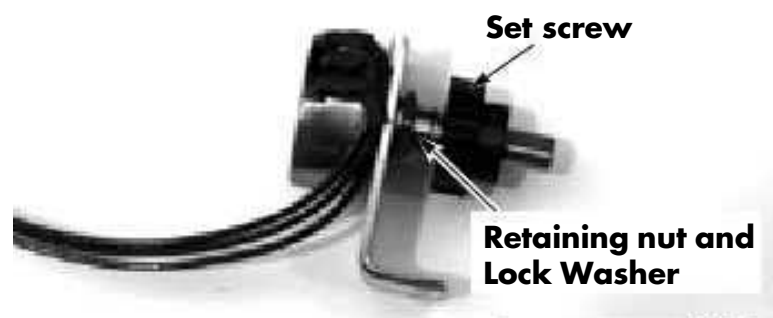

Figure 7-17. Travel Pot/Bracket Disassembly

5. Carefully remove heat shrink tubing from the terminals and identify the wires so they can be installed in the same location on the new pot.
6. Carefully unsolder the harness wires.
7. Slide 3/8 in. (9.5 mm) long shrink sleeving over previously sleeved wires.
8. Solder all electrical components to the harness. See "Hand Soldering Procedures" on page 7-17.
9. Shrink sleeving as necessary.
10. Assemble pot and bracket and install retaining nut and lock washer. When installing the travel pot into the bracket, leave the mounting nut finger tight. See Figure 7-17.
11. Install the gear on the pot shaft, aligning the set screw with the flat portion of the shaft.
12. Install the travel pot/bracket assembly into the enclosure. Engage the travel pot gear with the shaft gear (there is one large tooth that is used to align the gears). Tighten the pot gear set screw and torque to 3 to 4 in. lb. (0.3 to 0.4 N•m).

⚠ CAUTION

It is very easy to over torque and ruin the gear.

13. Tighten the two pan head machine screws on the back of the enclosure while moving the handle to ensure there is no binding. See [Figure 7-15](#).
14. Install the handle in the truck.
15. Adjust the travel pot. Run [Test A04 - Throttle Potentiometer Voltage \(Page 6-32\)](#) and adjust the travel pot voltages to the values given.
16. Tighten the retaining nut.
17. Install the cover on the travel pot enclosure with the four hex head cap screws. See [Figure 7-14](#).
18. Run Learn. See [“Learn Mode” on page 3-19](#).

Travel Spring and Pinion

Disassembly

1. Remove the four hex head cap screws from the front of the travel pot enclosure and remove cover. See [Figure 7-14](#).
2. Use a pin removal tool and pull pins 3 thru 6 from JC-9. These wires pass through the shaft to the lift/lower pot and horn switch.

NOTE: The washer and shims can easily slip off the shaft gear. Observe the correct position of these components before disassembling them.

3. Remove the button head screw from the shaft gear and slide shaft out of enclosure. See [Figure 7-16](#).
4. Carefully rotate the shaft gear assembly to disengage the spring tangs from the pin. Remove the shaft gear assembly from the enclosure.

Assembly

1. Slide the shaft gear assembly back into enclosure. Engage the travel pot gear with the shaft gear (there is one large tooth that is used to align the gears).

- a. Make sure the spring tangs straddle the pin (tangs must be parallel). If the spirol pins were replaced, make sure they are installed such that when the spring is installed, the spring sits on an even edge of the pin and not on the gap.

NOTE: Replace the spring if the tangs are not parallel. *Do not* bend the spring.

- b. Make sure the washer and shims are correctly aligned to allow the handle shaft to slide easily through the enclosure. See [Figure 7-18](#).



Figure 7-18. Travel Pot/Bracket Assembly Installation

2. Route the lift/lower pot and horn wires through the enclosure. Carefully slide the shaft through the enclosure, passing through the shaft gear assembly, washer, and shims.
3. Align the screw hole in the handle shaft with the hole in the shaft gear. Apply thread-locking compound (P/N 990-412) to the threads in the shaft and on the button head screw. Install the screw and torque to 8 to 12 in. lb. (0.9 to 1.3 N•m).
4. Reinstall the wire pins into the connector.

5. Inspect the tab on the plate ground to ensure that it is in contact with the bronze handle shaft bushing. See [Figure 7-19](#).



Figure 7-19. Plate Ground

6. Install the cover on the travel pot enclosure with the four hex head cap screws. See [Figure 7-14](#).

Lift/Lower Knob Installation/Adjustment

1. Rotate the lift/lower potentiometer shaft fully counterclockwise.
2. Install the lift knob on the potentiometer shaft. The pin on the knob must fit between the tangs of the potentiometer return spring.

Table 7-1. Control Handle Checks

Part	Check for:
Horn button assembly	Cracks or deformation
Lift/lower pot bracket	Cracks, deformation, loose dowel pin, over round or oversized shaft hole
Travel pot gear	Cracks, gear deformation, stripped threads
Travel shaft gear assembly	Cracks, gear deformation, or loose spirol pin
Travel pot enclosure	Cracks, loose spirol pin, stripped threads, deformation or indents on external stops
Handle halves	Cracks, damage or deformation/indents on external stops
Lift/lower knob	Cracks, deformation, stripped threads, loose dowel pin
Plate ground	Check for continuity between the control handle shaft and the truck frame
Other hardware	Stripped threads. All screw threads must be cleaned.

3. Rotate the lift/lower knob fully counterclockwise and tighten the metal set screws to 6 to 8 in. lb. (0.7 to 0.9 N•m).
4. Check the potentiometer for correct operation and spring return to neutral. Correct any binding.
5. Install and tighten two nylon set screws on top of the metal set screws.
6. Verify the potentiometer reference voltages. Refer to [Test A05 - Lift/Lower Potentiometer Voltage](#) on page 6-33.
7. Run Learn. See [“Learn Mode”](#) on page 3-19.

Cleaning and Inspection

CAUTION

When cleaning plastic parts, use a dry rag or a cleaner that is safe on plastics. Most chemicals can damage plastic.

While performing a repair on the Control Handle, clean and inspect the parts listed in [Table 7-1](#).

Hand Soldering Procedures

When hand soldering is performed on solid state potentiometers, the following is recommended:

- Flux - rosin base
- Solder - 60/40 rosin core or equivalent
- Solder Iron - 55 watt max.
- Tip Size - 0.118 in. (3 mm) dia. x 1.182 in. (30 mm) long screwdriver
- Tip Temperature - 500°F (260°C) max.
- Terminal Contact Time - 6 seconds max.

NOTE: Apply light soldering iron pressure on the terminal. Make sure the tip is clean. A dirty tip does not transfer heat well, therefore requiring longer dwell time and greater tip pressure.

CAUTION

Contact contamination can occur if cleaning solvent is allowed to enter switches or potentiometers.

After soldering, clean terminals with a brush dampened with an alcohol based cleaner (P/N 990-600/FOF). Make sure cleaner does not seep into the electrical component.

NOTE: Components damaged due to solvent saturation *will not* be covered under warranty.

Installation

1. Install control handle on truck. Connect JPC9.
2. Connect the ground wire to the truck frame.
3. Reconnect the battery connector and turn the key switch ON.
4. Perform Learn Controls and test truck operation before returning to service. See [“Learn Mode” on page 3-19.](#)

Deadman Pedal

Switch Replacement

There are two deadman switches (S2 and S23).

Trucks S/N 00100 thru 00133

1. Raise operator platform high enough (at least 3 ft. [91.44 cm]) to access bottom of deadman pedal from under platform.
2. Block operator platform with a 4 in. x 4 in. (100 x 100 mm) wooden block.
3. Turn the key switch OFF and disconnect the battery connector.
4. Remove snap ring from bottom of deadman pedal post. See [Figure 7-20](#).
5. While holding the two return springs in place, lift pedal straight up.

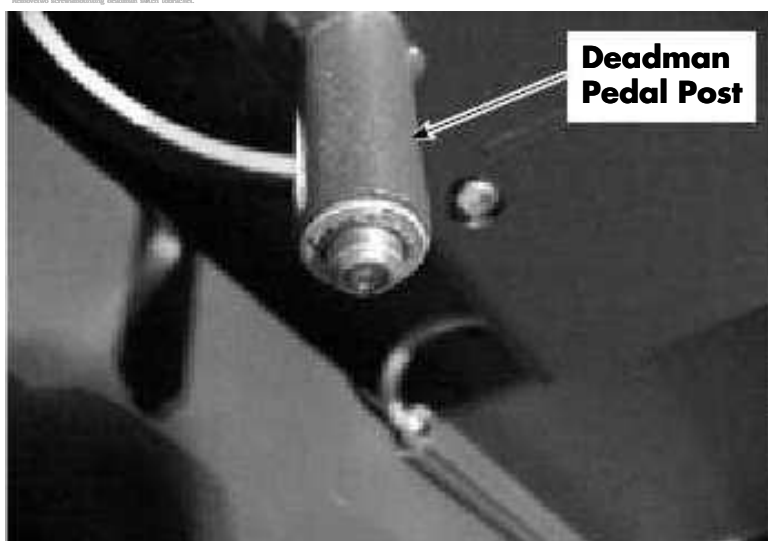

Figure 7-20. Deadman Pedal Post Under Platform

6. Remove two screws mounting deadman switch to bracket.
7. Disconnect wires from deadman switch(es). Note location and mark if necessary for recognition later.

8. Replace bad switch(es). See [Figure 7-21](#).

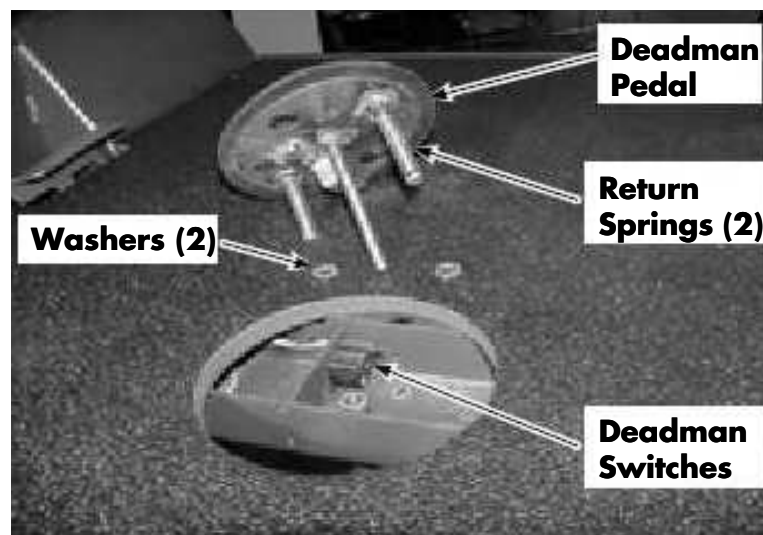

Figure 7-21. Deadman Pedal Components

9. Reconnect wires.
10. Align washers with holes.
11. While holding the two return springs in place, install pedal assembly. See [Figure 7-21](#).
12. Install snap ring on bottom of deadman pedal post.
13. Reconnect the battery connector and turn the key switch ON. Test truck operation before returning to service.

Trucks S/N 00134 and Higher

1. Raise operator platform high enough (at least 3 feet [91.44 cm]) to access bottom of deadman pedal from under platform.
2. Block operator platform with a 4 in. x 4 in. (100 x 100 mm) wooden block.
3. Turn the key switch OFF and disconnect the battery connector.

4. Remove the three lock nuts and washers that secure the deadman pedal assembly to the operator platform. See [Figure 7-22](#).

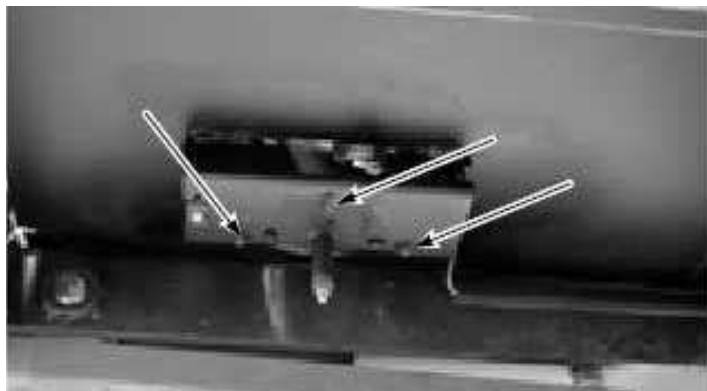

Figure 7-22. *Deadman Lock Nuts and Washers*

5. Remove the two screws mounting the deadman switch(es) to the bracket.
6. Disconnect wires from switch(es). Note location and mark if necessary for recondition later.
7. Replace bad switch(es).
8. Reconnect wires.
9. Align pedal assembly with holes in platform.
10. Install washer and lock nut on bottom of each deadman pedal assembly post. See [Figure 7-22](#).
11. Reconnect the battery connector and turn the key switch ON. Test truck operation before returning to service.

Emergency Power Off Switch

6. Reconnect the battery connector and turn the key switch ON. Test truck operation before returning truck to service.

Removal

1. Turn the key switch OFF and disconnect the battery connector.
2. Remove operator console cover.
3. Disconnect wires EPO-1 and EPO-2 from back of EPO switch. See [Figure 7-23](#).

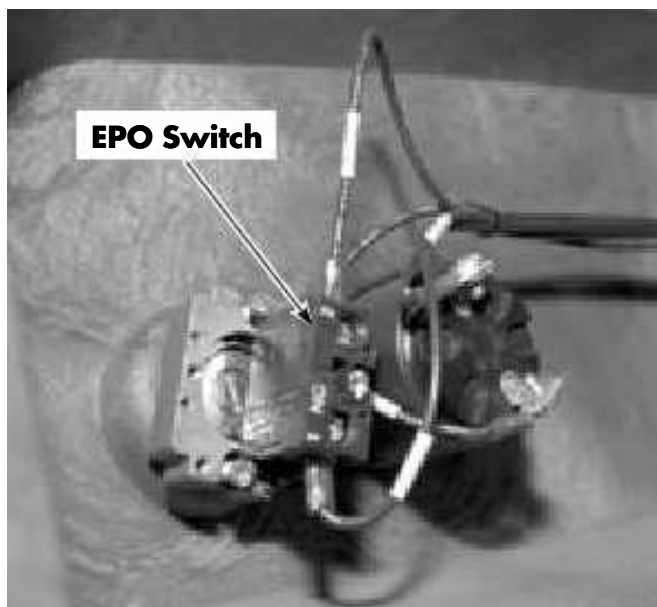

/144/_0

Figure 7-23. EPO Switch

4. Loosen two screws on backside of EPO switch.
5. Hold lower half of switch, push in and rotate top half 90° counterclockwise to unlock halves of EPO switch.

NOTE: The switch may be hard to turn.

6. Lift top half of EPO switch from bezel.

Installation

1. Insert lower portion of EPO switch in its hole in bezel.
2. Slide upper half of EPO switch over lower half until it is seated. Rotate top half 90° clockwise to lock.
3. Tighten screws on backside of EPO switch.
4. Re-connect wires.
5. Install operator console cover.

Drive and Brake

Drive Motor

Refer to AC Motor Service on page 7-68 for drive motor temperature sensor and encoder bearing replacement procedures.

Removal/Installation

1. Turn the key switch OFF and disconnect the battery connector.
2. Remove brake assembly including the rotor hub nut and rotor hub. See Figure 7-24. Note the number of spacers used.



Figure 7-24. Drive Motor

3. Identify and remove power cables from drive motor.
4. Remove the drive motor retaining screws.

5. Remove the drive motor.
6. For reassembly, reverse steps 1 thru 5 noting the following:
 - Clean motor mounting flange and drive unit. Install a new gasket.
 - Clean screws. Apply thread-locking compound (P/N 990-536) to screws and torque equally to 13 ft. lb. (18 N•m).
 - Torque the power cable nuts to 18 ft. lb. (24.4 N•m). See Terminal Hardware on page 7-66.
 - Check brake adjustment. See Brake Adjustment on page 7-54.
7. If the pinion on the drive motor needs to be installed:
 - a. Clean threads using thread-locking compound primer (P/N 990-533).
 - b. Install key and gear.
 - c. Apply thread-locking compound (P/N 990-462) to threads.
 - d. Torque nut to 85 ft. lb. (115 N•m).

Drive Unit - Standard

Pivot Ring Inspection

The fit of pivot ring bearings in the drive unit is such that some play is expected. However, as the rings wear, the play may increase. If the play is permitted to become extreme, it will become quite noticeable in the drive unit.

If worn rings are suspected as the cause of excessive play in the drive unit, inspect the drive housing to determine if the bearing radial rings must be replaced:

1. Jack the tractor of the truck up just enough to permit the drive tire to clear the floor.

⚠ WARNING

Use extreme care whenever the truck is jacked up. Keep hands and feet clear from vehicle while jacking the truck. After the truck is jacked, place solid blocks beneath it to support it. Do not rely on the jack alone to support the truck.

2. Place a magnetic base dial indicator on the deck plate and position the indicator point on top of the drive unit top cover.
3. Adjust the dial indicator to zero then lower the truck to the floor.
4. Note the new indicator reading. If the reading is 0.089 in. (2.26 mm) or less the radial rings do *not* have to be replaced. If the reading exceeds 0.089 in. (2.26 mm) the rings must be replaced. If the reading is between 0.055 and 0.089 in. (1.4 and 2.26 mm) the bearing rings must be checked during future scheduled maintenance visits.

Drive Unit Removal

1. Turn the key switch OFF and disconnect the battery connector.
2. Remove the bumper gate. See Figure 7-25.

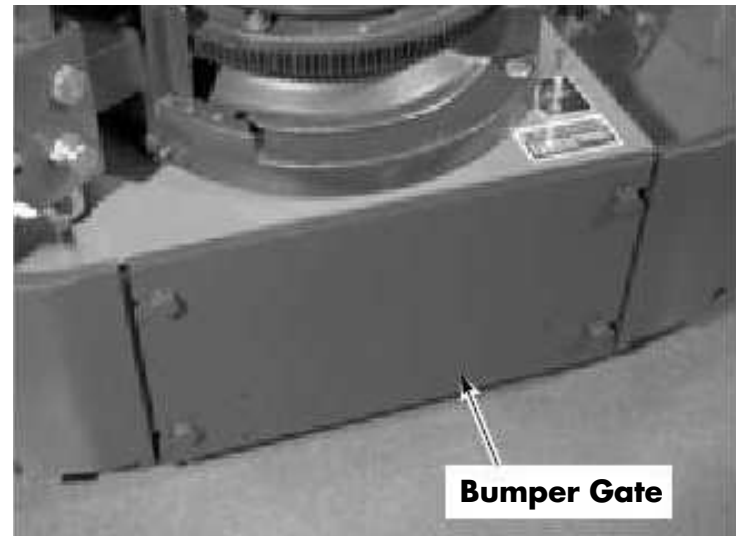

Figure 7-25. Removing Drive Unit

3. If the truck is wire guided, remove the sensor mounted on the backside of the bumper gate.
4. If the drive tire is to be removed, loosen the lug nuts.
5. Remove the proximity sensor and associated hardware on the drive unit casting.
6. Remove drive motor. See Drive Motor on page 7-22.

NOTE: If the drive unit is the only item requiring service, separating the brake assembly from the drive motor is not necessary.

⚠ WARNING

Use extreme care whenever the truck is jacked up for any reason. Never block the truck between the telescopic and the floor. Use a suitable hoist to stabilize the mast. Keep hands and feet clear from beneath vehicle while jacking. Use jack stands or solid blocks to support truck. DO NOT rely on the jack alone. See Jacking on page 2-8.

7. Jack and block the tractor so the drive tire is off the floor.
8. Drain oil from drive unit.
9. Unbolt the lift/lower manifold from the drive unit casting.

10. Remove the steering motor/gear reducer assembly.
11. Remove cap screws holding the drive unit assembly to the tractor.
12. Lift drive unit out of tractor frame using a suitable lifting device.
13. Clean the outside of the drive unit thoroughly and drain any remaining oil from the drive unit by removing the drain plug.



71826_006.tif

Figure 7-26. Inspect Housing for Hub Wear

14. Visually inspect the outside of the housing for damage, wear, or cracks. Pay particular attention to the area where hub wear may be evident.

Pivot Ring Disassembly

1. Remove the bearing filler plug screws using a 1/2 in. socket. See Figure 7-27.



71826_011.tif

Figure 7-27. Bearing Filler Plug Screws Removal

2. Remove the bearing filler plug with grease fitting.
3. Remove the steel balls through the bearing filler plug hole. To work the steel balls forward, insert a putty knife between the pivot ring and the housing. See Figure 7-28. Use care to prevent damaging the radial rings. Move the pivot ring slightly from side to side while working the putty knife toward the bearing filler plug hole.

NOTE: If the pivot ring will not spin or even turn, it is an indication of damaged radial rings and/or excessive wear to the channel in the housing. If this is the case, replace the entire drive unit. No further disassembly is necessary.



1826_014.tif

Figure 7-28. Remove Steel Ball Bearings

4. After removing all the steel balls, remove the pivot ring by lifting it off, toward the drive end of the housing. See Figure 7-29.



71826_015.tif

Figure 7-29. Pivot Ring Removal

the dial indicator probe perpendicular to the gear tooth surface.

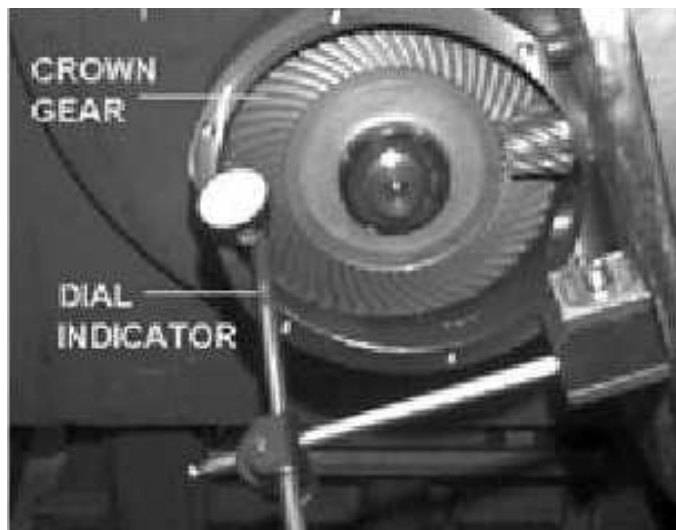

7diol.tif

Figure 7-84. Dial Indicator Position

3. Zero the indicator. Clasp the bottom of the gear and rotate it. Read the backlash measurement on the dial indicator. **Total backlash tolerance is between 0.004 and 0.006 in.**

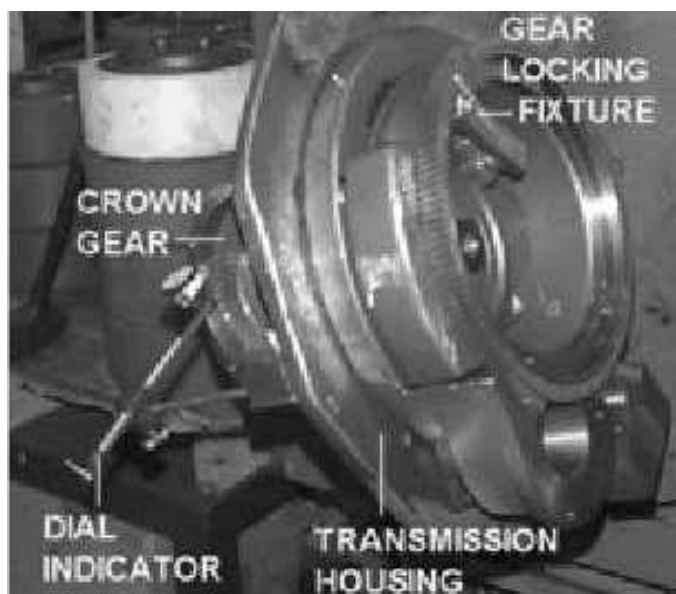

7backsh.tif

Figure 7-85. Measure Backlash

4. If the tolerance is not within the acceptable limits, calculate any necessary adjustments to the shims. Remove the clamp nut, axle assembly, and bevel gear. Install the correct amount of shims, and repeat Steps 3 and 4 of "Housing Bearing Cup and Shim Assembly" procedure on page 7-33.

Repeat steps 1 thru 3 of this procedure until the backlash is between 0.004 and 0.006.

5. When backlash is within the acceptable range, install the pivot ring.

Pivot Ring Assembly

1. Place a light coating of thread-locking compound (P/N 990-544) in the hole on the pivot ring assembly.
2. Line up the grease fitting hole with the grease fitting port. See Figure 7-86.



71826_111.tif

Figure 7-86. Spherical Bearing Alignment

3. Install the spherical bearing using a mallet or press. See Figure 7-87.



71826_112.tif

Figure 7-87. Install Spherical Bearing

4. Install the grease fitting in the pivot ring assembly using a grease fitting driver and a mallet or press. See Figure 7-88.

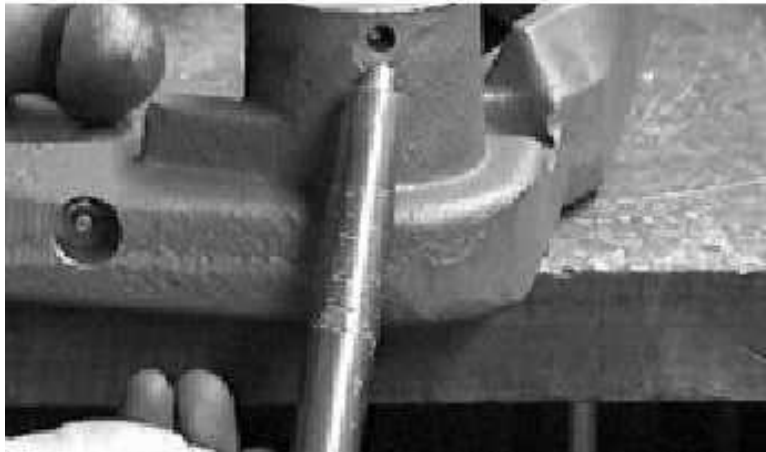

71826_113.tif

Figure 7-88. Grease Fitting Installation

5. On the inside of the pivot ring, make sure the roll pins are installed and in good condition on either side of the bearing filler plug hole. If they are missing or damaged, install new roll pins. See Figure 7-89.

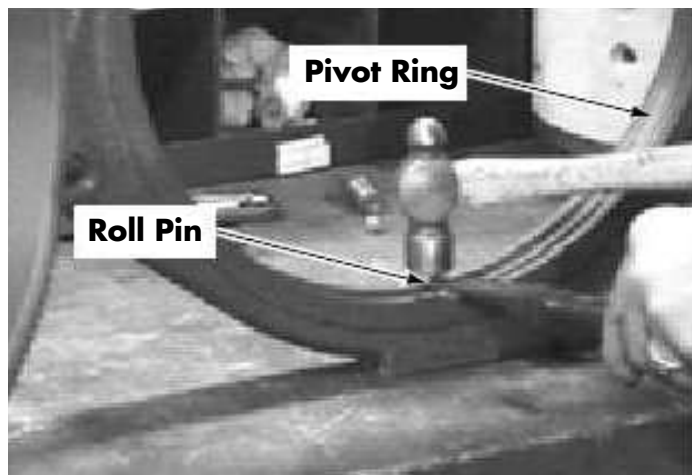

71018_035.tif

Figure 7-89. Roll Pin Installation

6. Install the radial rings so that the gap aligns with the bearing hole. Install the flat radial ring on the inside flat surface of the pivot ring. Then install the chamfered radial rings to the pivot ring. The chamfered edges will face the steel balls. The ends of the radial ring are against the roll pins. See Figure 7-90.

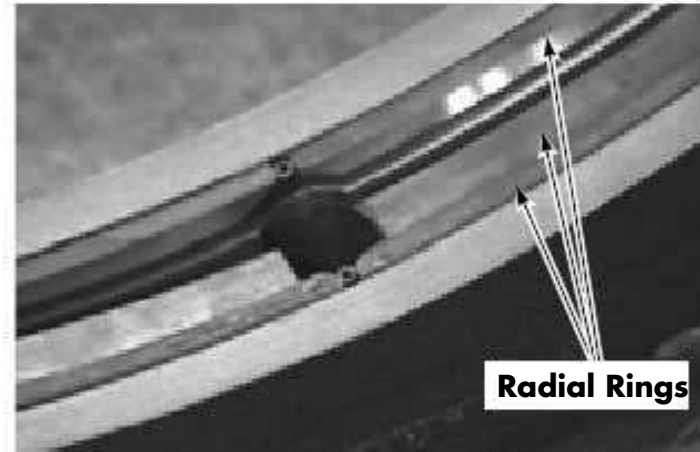

71018_036.tif

Figure 7-90. Radial Ring Installation

7. Install the brass bushing using a mallet or press. See Figure 7-91.



71826_125.tif

Figure 7-91. Brass Bushing Installation

Drive Unit Assembly

1. Install the radial rings on the housing. Stagger the ends of the rings around the housing so the gaps are not aligned. The beveled edges will face the steel balls. See Figure 7-92.



71826_116.tif

Figure 7-92. Radial Ring Installation on Housing

2. Install the pivot ring assembly to the housing. The spherical bearing should face the spur gear. See Figure 7-93.



71826_117.tif

Figure 7-93. Pivot Ring Installation

3. Place one steel ball at a time into the pivot ring filler hole. Use a screwdriver to direct the steel balls first to one side then the other. See Figure 7-94.

NOTE: Count the steel balls as they are inserted in the pivot ring assembly for correct pivot ring operation. The drive unit requires 65 balls. Too many balls will cause binding and too few balls will cause excessive motion.



71018_038.tif

Figure 7-94. Ball Bearing Installation

4. Place the bearing filler plug in the filler hole. The grease fitting should face the spur gear.



71826_119.tif

Figure 7-95. Bearing Filler Plug Installation

CAUTION

Excessive thread-locking compound will damage the ball bearings and pivot ring. Use thread-locking compound sparingly.

5. Apply thread-locking compound (P/N 990-536) sparingly to the filler plug bolts. Install the bolts and flat washers on each side of the grease fitting. Tighten to 20 ft. lbs. (27 N•m). See Figure 7-96.



71826_121.tif

Figure 7-96. Filler Plug Bolt Installation

6. Grease and then test the pivot ring. Check to see that it spins freely.

Housing Cover Installation

1. Clean the cover mating surface. Apply gasket compound (P/N 990-443) to the surface where the cover contacts the housing. See Figure 7-97.



71826_123.tif

Figure 7-97. Apply Gasket Compound

2. Install the cover bolts. Torque to 20 ft. lbs. (27 N•m). See Figure 7-98.



71826_124.tif

Figure 7-98. Tighten Cover Bolts

3. Apply thread-locking compound (P/N 990-626) to the drain plug.
4. Install the drain plug in the cover plate. Torque to 15 ft. lbs. (20 N•m).

Drive Unit - Heavy Duty

Pivot Ring Inspection

The fit of pivot ring bearings in the drive unit is such that some play is expected. However, as the radial rings wear, the play may increase. If the play is permitted to become extreme, it will become quite noticeable in the drive unit.

If worn rings are suspected as the cause of excessive play in the drive unit, inspect the drive housing to determine if the bearing radial rings must be replaced:

1. Jack the tractor of the truck up just enough to permit the drive tire to clear the floor.

⚠ WARNING

Use extreme care whenever the truck is jacked up. Keep hands and feet clear from vehicle while jacking the truck. After the truck is jacked, place solid blocks beneath it to support it. Do not rely on the jack alone to support the truck.

2. Place a magnetic base dial indicator on the deck plate and position the indicator point on top of the drive unit top cover.
3. Adjust the dial indicator to zero then lower the truck to the floor.
4. Note the new indicator reading. If the reading is 0.089 in. (2.26 mm) or less the radial rings do *not* have to be replaced. If the reading exceeds 0.089 in. (2.26 mm) the rings must be replaced. If the reading is between 0.055 and 0.089 in. (1.4 and 2.26 mm) the bearing rings must be checked during future scheduled maintenance visits.

Drive Unit Removal

1. Turn the key switch OFF and disconnect the battery connector.
2. Remove the bumper gate. See Figure 7-99.

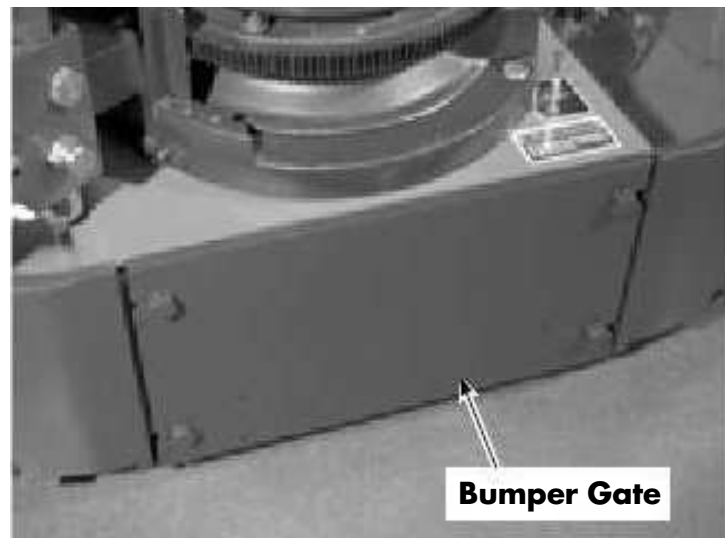

Figure 7-99. Removing Drive Unit

3. If the truck is wire guided, remove the sensor mounted on the backside of the bumper gate.
4. If the drive tire is to be removed, loosen the lug nuts.
5. Remove the proximity sensor and associated hardware on the drive unit casting.
6. Remove drive motor. See Drive Motor on page 7-22.

NOTE: If the drive unit is the only item requiring service, separating the brake assembly from the drive motor is not necessary.

⚠ WARNING

Use extreme care whenever the truck is jacked up for any reason. Never block the truck between the telescopic and the floor. Use a suitable hoist to stabilize the mast. Keep hands and feet clear from beneath vehicle while jacking. Use jack stands or solid blocks to support truck. DO NOT rely on the jack alone. See Jacking on page 2-8.

7. Jack and block the tractor so the drive tire is off the floor.
8. Drain oil from drive unit.
9. Unbolt the lift/lower manifold from the drive unit casting.

10. Remove the steering motor/gear reducer assembly.
11. Remove cap screws holding the drive unit assembly to the tractor.
12. Lift drive unit out of tractor frame using a suitable lifting device.
13. Clean the outside of the drive unit thoroughly and drain any remaining oil from the drive unit by removing the drain plug.
14. Visually inspect the outside of the housing for damage, wear or cracks.

Pivot Ring Disassembly

1. On the pivot ring, remove the grease fitting and the bearing filler plug. Inspect the bearing filler plug hole for uneven wear. See Figure 7-100.

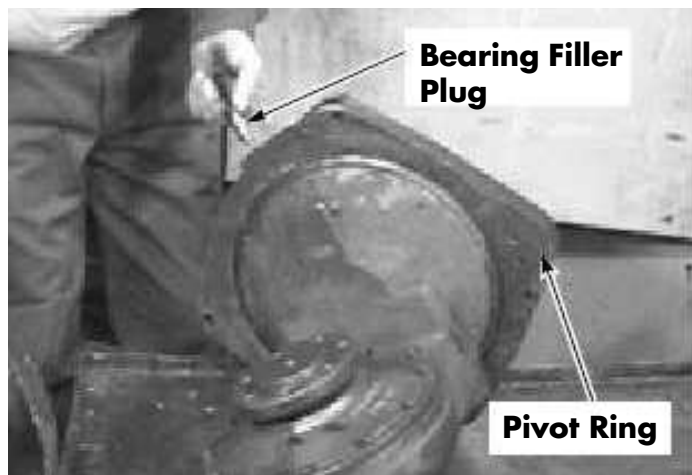

Figure 7-100. Grease Fitting and Filler Plug Removal

2. Turn the pivot ring to remove the steel balls through the bearing filler plug hole. See Figure 7-101.

NOTE: If the pivot ring will not spin or even turn, it is an indication of damaged radial rings and/or excessive wear to the channel in housing. If this is the case, replace the entire drive unit. No further disassembly is necessary.



Figure 7-101. Remove Steel Ball Bearings

3. After removing all the steel balls, remove the pivot ring by working it off toward drive end of the housing. See Figure 7-102.



Figure 7-102. Pivot Ring Removal

4. Remove the radial rings from the channel in the housing and inside the pivot ring. See Figure 7-103.



Figure 7-103. Radial Ring Removal

- Remove the roll pins and grease fittings from the pivot ring to ensure thorough cleaning.

⚠ CAUTION

Due to normal or excessive wear, the edges of the radial rings could be very sharp.

- Clean the grease from the radial ring channel in the housing. Inspect the channel for uneven wear. Also clean and inspect the inside of the pivot ring.

Main Cover and Output Shaft Disassembly

- Visually inspect the housing around the main cover for wear outside the cover bolts.

NOTE: Excessive housing wear outside the cover bolts can make them difficult to remove. If this occurs, replace the entire drive unit. No further disassembly is necessary.

- Remove the main cover bolts.
- Using a mallet, knock the flanged output shaft to break the seal on the main cover.
- Remove the main cover and output shaft assembly. See Figure 7-104.

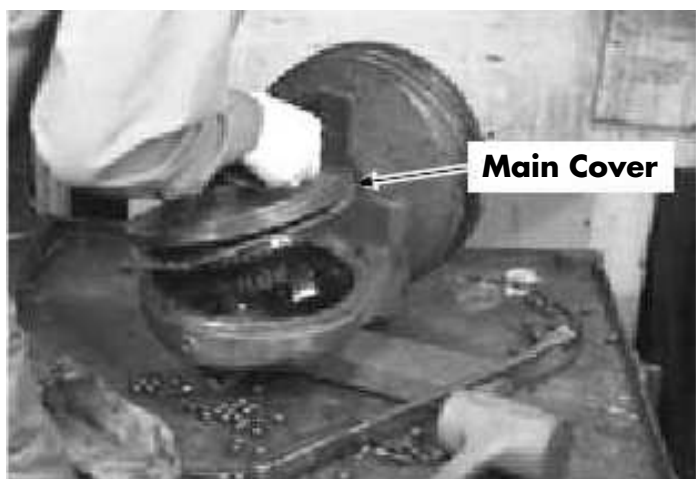

Figure 7-104. Cover and Output Shaft Removal

- A press and 8 in. x 6 in. tube are required to remove the bearing cup on the end of the output shaft.

⚠ CAUTION

Always watch for pinch points when using a press or pressing tools.

Safety glasses are required after this point in disassembly.

- Place the main cover assembly, gear side down, on the tube under press. Press the output shaft down slightly to create a space between the bevel gear and the output bearing spacer. See Figure 7-105.

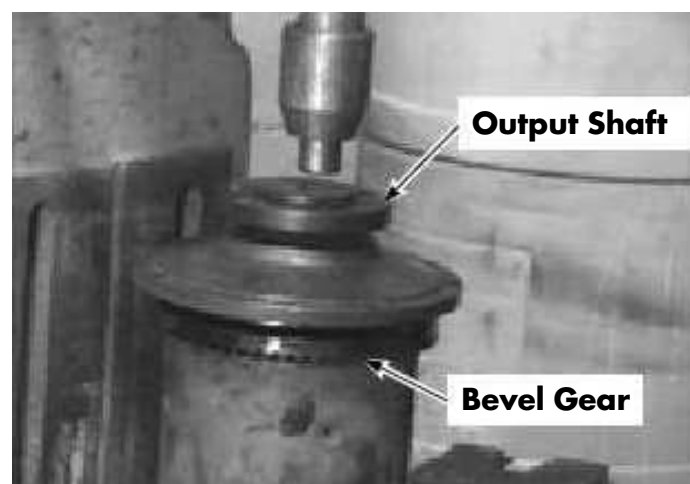

Figure 7-105. Press Down Output Shaft

- Tighten a bearing puller clamp under the lip of the output bearing spacer, being careful not to catch the exterior retaining ring. See Figure 7-106.



Figure 7-106. Bearing Puller Clamp Installation

- Place the main cover assembly, gear side up, on a 12 in. x 6 in. tube so the bearing puller clamp is resting on the tube. Press

out the flanged output shaft and the output bearing spacer.

9. Remove the exterior retaining ring.
10. To remove the bevel gear, support the main cover assembly on an 8 in. x 6 in. tube under press. Press the output shaft down through the bevel gear. The bearing cone is removed at the same time. See Figure 7-107.

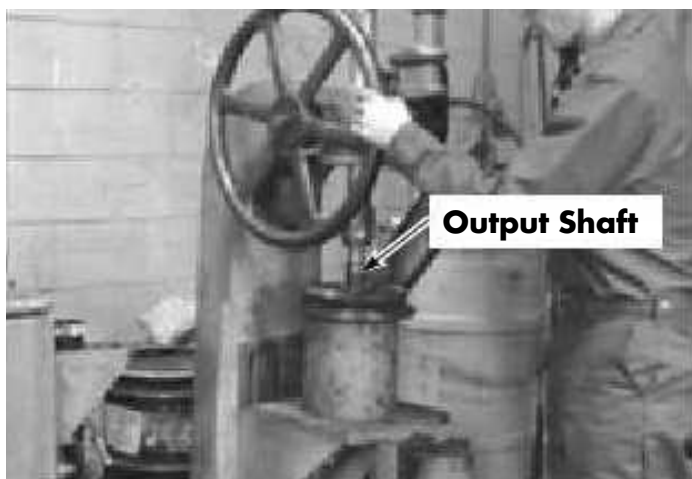

Figure 7-107. Bevel Gear Removal

11. Remove the bearing cup from the main cover with a race driver and pry bars.
12. Remove the lip seal from the main cover. See Figure 7-108.

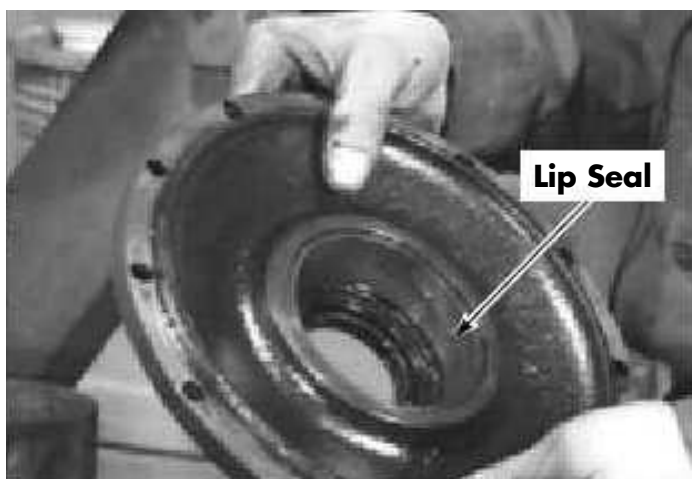

Figure 7-108. Bearing Cup and Lip Seal Removal

13. Remove the output shaft bearing cone in the base of the housing using two pry bars. Insert the pry bars under the bottom edge of the cone on opposite sides. Apply even pressure on both tools to lift the cone out. See Figure 7-109.

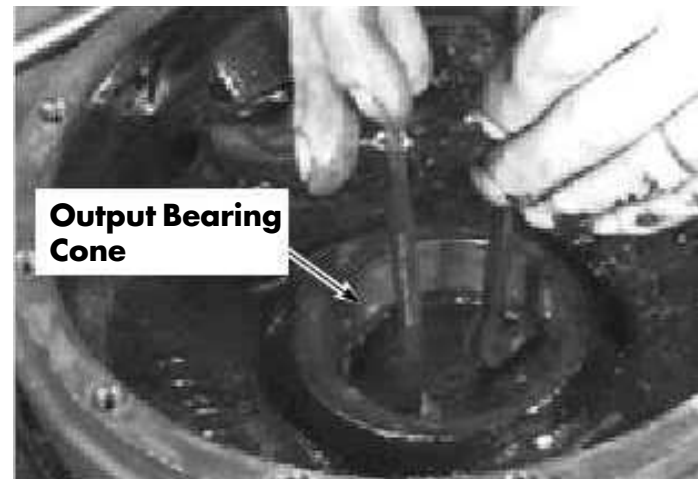

Figure 7-109. Output Shaft Bearing Cone Removal

14. Remove the shims from the housing bore. Save shims for reference only, as they are usually damaged when removing the bearing cone.
15. Remove the cover shims. Save the shims for reference only.

Spiral Pinion Disassembly

NOTE: The spiral pinion and bevel gear are a matched set. Their alignment is critical. Do not replace them separately.

1. Loosen the set screw on the clamp nut on the spiral pinion gear shaft. Using Tool 761-870/T03, remove the clamp nut. See Figure 7-110.

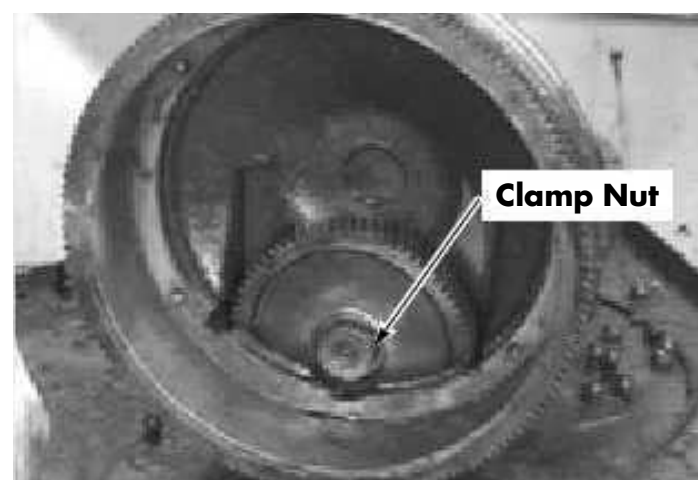

Figure 7-110. Clamp Nut Removal

2. Using a brass punch and hammer, drive the spiral pinion gear shaft out of the housing. See Figure 7-111.

Brake

The brake assembly is mounted on top of the drive motor. The brake is spring applied and electrically released. The brake can be manually released by installing the brake release bolts. See Figure 7-137.

⚠ WARNING

When brake release bolts are used, make sure they are removed before the truck is returned to service. If the bolts are not removed, the brake will not work correctly.

Brake Adjustment

Inspect the brake gap inspections on a regular schedule.

⚠ WARNING

Use extreme care whenever the truck is jacked up for any reason. Never block the truck between the telescopic and the floor. Use a suitable hoist to stabilize the mast. Keep hands and feet clear from beneath vehicle while jacking. Use jack stands or solid blocks to support truck. DO NOT rely on the jack alone. See Jacking on page 2-8.

1. Jack and block the tractor so the drive tire is off the floor.
2. With the brake de-energized (fully applied), use a feeler gauge to measure the total gap. See Figure 7-137.
3. Take measurements at three equally-spaced locations around the armature disk. The total gap must be 0.010 to 0.015 in. (0.25 to 0.38 mm). The gap must be uniform all the way around the armature disk. Brake wear is indicated if the total gap is greater than 0.015 in. (0.38 mm).

NOTE: Different thickness shims and spacers are available to maintain correct brake gap.

4. Add/remove shims as necessary to achieve the correct gap.

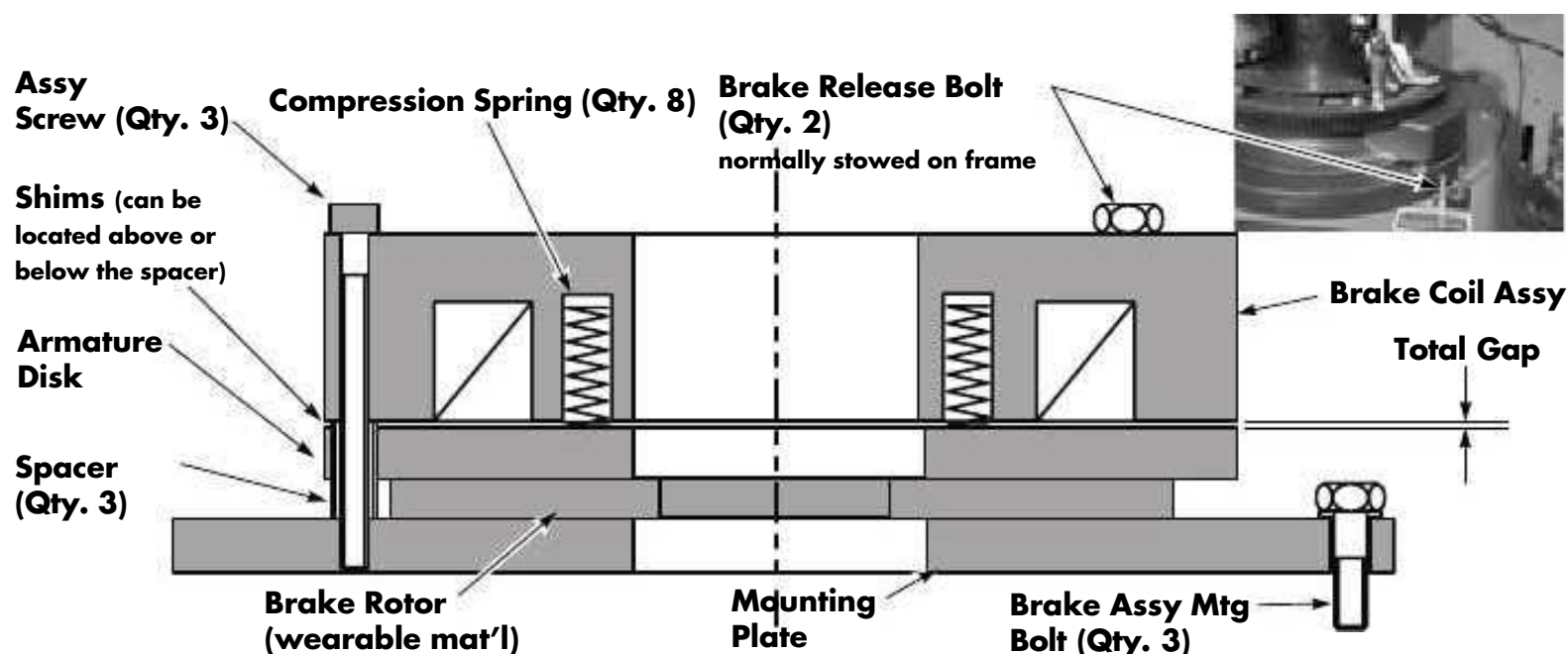

Figure 7-137. Brake Assembly Components

7

Brake Rotor Replacement

Replace the rotor if worn to a thickness of 0.236 in. (6 mm) or less.

Removal/Disassembly

1. Turn the key switch OFF and disconnect the battery connector.
2. Remove the covers from the power section.
3. Disconnect the electrical cable to the brake assembly.
4. Remove the three screws that secure the brake to the drive unit.
5. Remove the cable support.
6. Lift the brake unit up and off the drive unit. Take the assembly to a workbench. You will need the brake release screws located on the tractor.
7. Insert the brake release screws into the brake assembly. Tighten the two brake release screws to release the brake completely.
8. Remove one of the three screws that hold the brake assembly together. Use care not to lose any shims that may be used.
9. Slide the rotor out of the assembly.

Assembly/Installation

1. Slide the new rotor into the assembly. The rotor is positioned between the armature disk and the brake mounting plate. See Figures 7-138 and 7-139.
2. Install the one assembly screw removed to replace the rotor. Make sure to install any spacers removed. Torque the three M6 screws that secure the coil to the assembly to 9 ft. lb. (12 N•m) with the threads lubricated.
3. Carefully center the rotor within the assembly and remove the brake release bolts.
4. Measure the total gap as shown below. The total gap must be between 0.010 in. (0.25 mm) and 0.015 in. (0.38 mm). If the gap is not within tolerance, add or remove shims and/or spacers as necessary. Different thickness shims and spacers are available.

CAUTION

If the total gap exceeds 0.015 in. (0.38 mm), brake release problems will result particularly when the brake is hot and/or the battery is low.

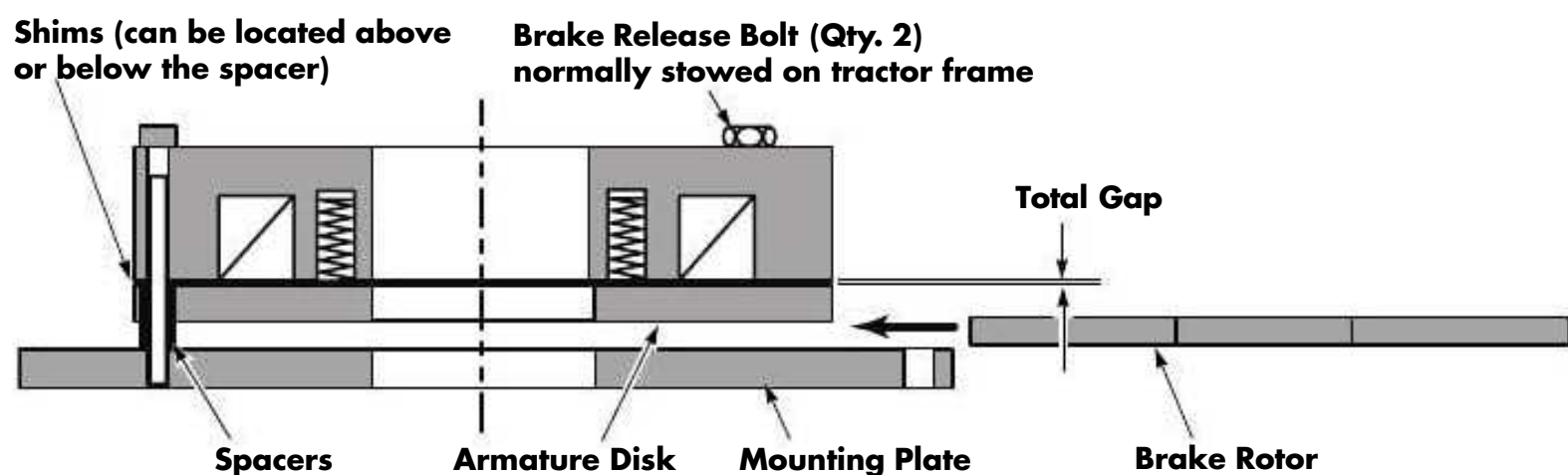

Figure 7-138. Installing Brake Rotor

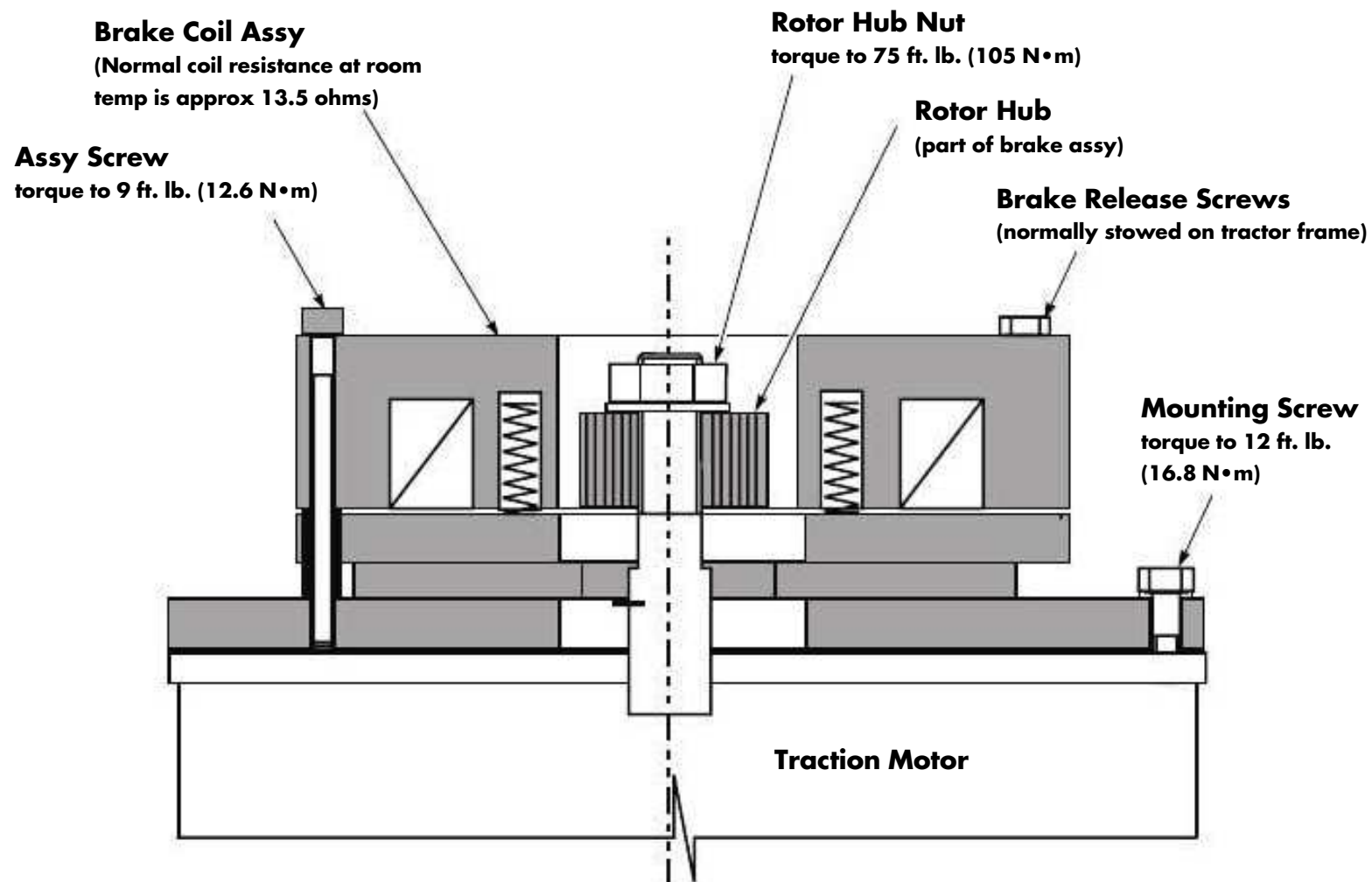

Figure 7-139. Brake Assembly - Section View

5. After the correct gap is achieved, torque the assembly screws as specified in step 2.
6. Inspect the splines on the rotor hub (on the drive motor). If the splines on the rotor hub have excessive wear, replace the hub before proceeding. Using a rotor hub with worn splines may cause rotor damage when the truck is driven.
7. Carefully install the brake assembly on the drive motor. It is critical that the splines on the rotor are not damaged during assembly.
8. Install the cable clamp that holds the power cables on the drive motor.
9. Secure the brake assembly to the drive motor. Apply thread-locking compound (P/N 990-462). Torque the three mounting screws to 12 ft. lb. (16.8 N•m).
10. Connect the brake to the truck electrical circuit.
11. If the rotor hub nut was removed, apply thread-locking compound (P/N 990-462) to threads on rotor hub nut. Install then torque the rotor hub nut holding the rotor hub to 25 ft. lb. (35 N•m).

CAUTION

Damaging the splines on the brake rotor may cause brake failure.

8. Install the cable clamp that holds the power cables on the drive motor.

⚠ WARNING

Make sure the brake release bolts are removed before placing the truck back into service. If the brake release bolts are not removed, the brake will not work correctly.

12. Reconnect the battery connector and turn the key switch ON.

⚠ WARNING

If the brake does not work while performing the next step, the truck will not stop but will coast for approximately 30 ft. (9 m).

13. Test the brake. In an open area allowing for travel over a long distance, perform the following:
 - a. Drive the truck approximately 2-3 mph (3.2-4.8 km/h).
 - b. Push the EPO switch. The truck should stop within approximately 2 to 4 ft. (0.6 to 1.2 m).

⚠ WARNING

Stepping off the deadman pedal does not test the brake.

NOTE: During acceleration a slight rattle from the brake rotor is considered normal and does not affect brake durability or function.

14. Install covers.

⚠ CAUTION

Do not separate piston from piston plug unless necessary. If disassembly is required, use a strap wrench only. Do not damage piston surface.

NOTE: When repacking the cylinder, replace all packings. See Parts Catalog for packing kits.

11. Install seal kit on cushion piston. See [Figure 7-168](#).

Tip: Twisting the fiber rings prior to installation helps them retain their “memory.” See [Figure 7-169](#).

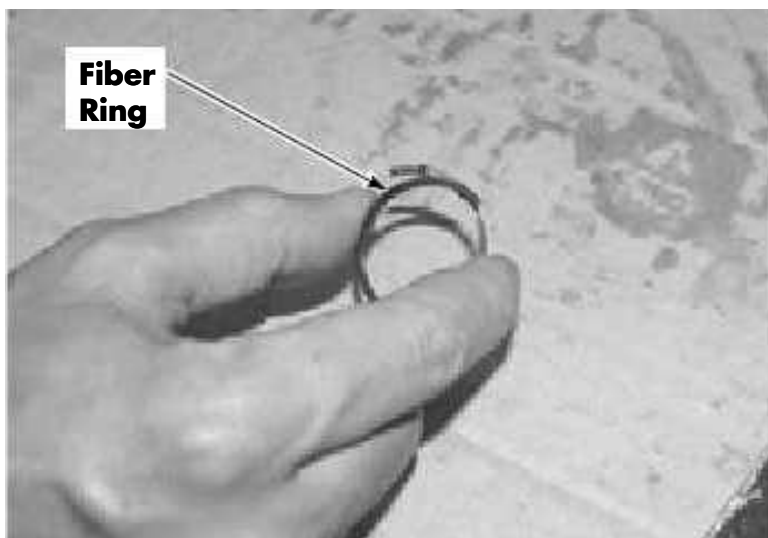

Figure 7-169. Twisting Fiber Rings

12. Install spring. Make sure it is fully seated in cushion piston.
13. Install cushion piston.
14. Install retaining ring and snap ring.

15. Install cylinder in truck. See [Side Lift Cylinder on page 7-84](#).



Figure 7-170. Cushion Assembly

Cleaning

1. Flush inside of housing.
2. Wipe piston with clean kerosene or suitable industrial solvent.
3. Inspect all surfaces for galling or heavy scratches. Remove minor damage with a fine emery cloth.
4. Inspect all parts: replace as necessary.

Seal Repacking

1. Remove cylinder. See [Side Lift Cylinder on page 7-84](#).

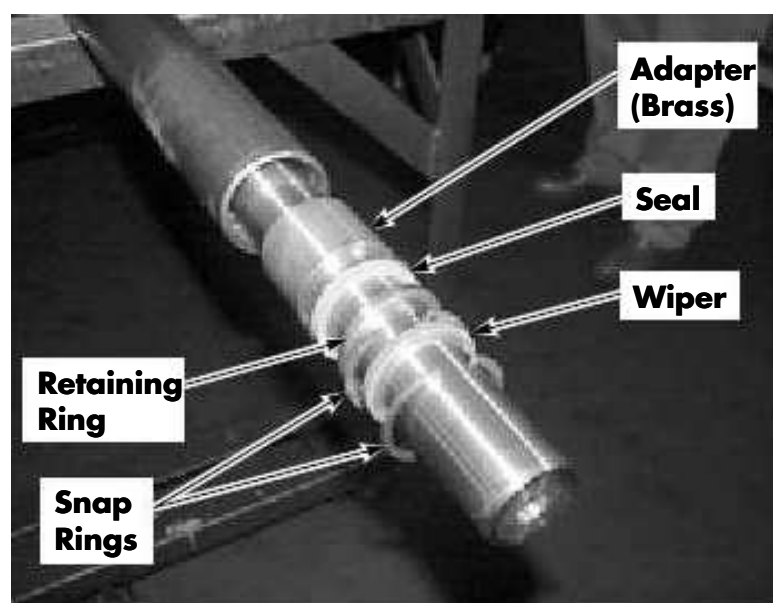

Figure 7-171. Packing Components on Side Cylinder

⚠ CAUTION

Do not damage chrome plating on piston.

2. Remove snap rings, seals, retaining ring and brass adapter. See [Figure 7-171](#).
3. Dip all packings in clean hydraulic fluid.
4. Lubricate inside of cylinder housing with hydraulic fluid.

NOTE: To prevent damage to packings at the top of the cylinder, use the following tools:

- Service driver, P/N 401-000-050
- Service guide, P/N 401-000-051

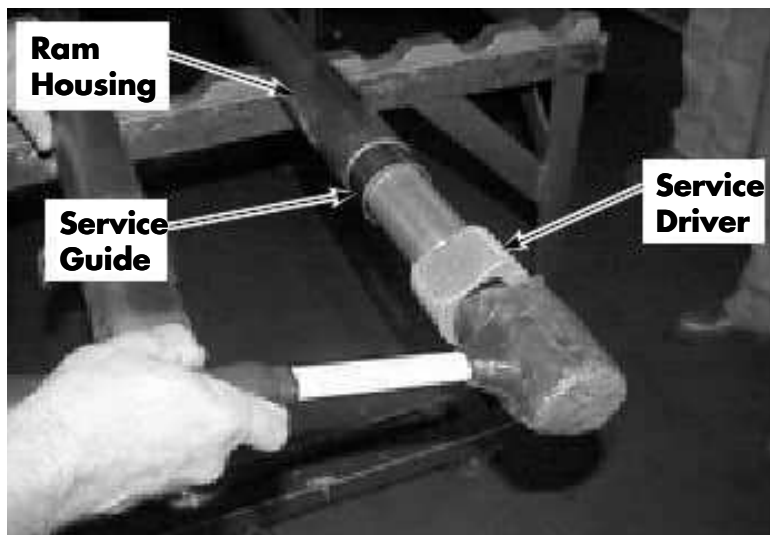

Figure 7-172. Using Cylinder Service Tools

5. Slide brass adapter on piston.
6. Install piston assembly into housing.
7. Install service guide. See [Figure 7-172](#).
8. Dip seal in oil and slide over piston, back first.
9. Drive seal into assembly with driver. See [Figure 7-172](#).
10. Remove service guide.
11. Install packing backup ring.
12. Install snap ring.
13. Install wiper.
14. Install snap ring.
15. Install cylinder. See [Side Lift Cylinder on page 7-84](#).

Center Lift Cylinder

Removal

1. Remove carriage. See [Carriage on page 7-92](#).



Figure 7-173. Center Cylinder, Bottom View

2. Remove snap ring and washer from bottom of center cylinder. See [Figure 7-173](#).
3. Remove and cap hydraulic hoses.
4. Remove U-shaped bracket.
5. Remove center cylinder.

Installation

1. Install center cylinder. Make sure the bushing is on the mounting bolt.
2. Install washer and snap ring to bolt under center cylinder. See [Figure 7-173](#).
3. Install U-shaped bracket.
4. Install carriage. See [Carriage on page 7-92](#).
5. Install end cap on center cylinder.
6. Connect power and test lift function before returning truck to service.

Service of Cylinder with Cushions

Cushion Replacement

Refer to [Figure 7-174 on page 7-89](#) for the following steps.

1. Remove retaining ring and top bearing .

NOTE: When the retaining ring is removed, a spring behind the top bearing may push the bearing out of the housing.

2. Remove the spring and pressure ring .
3. Remove the three Torx screws located about 6 in. from the top of the housing.
4. Remove piston from cylinder housing.
5. Remove the cushion assembly.
6. Coat the threads of the new cushion assembly with thread-locking compound primer (P/N 990-533) and apply thread-locking compound (P/N 990-571).
7. Assemble the new cushion assembly to piston rod.
8. Re-install piston assembly in cylinder housing.
9. Re-install the three Torx screws.
10. Lightly oil a new seal and install in pressure ring. Check to make sure the small orifice in the pressure ring is not obstructed.
11. Install spring.
12. Remove the bad parts from the top bearing.
13. Lightly oil new seal, O-ring, backup ring and wiper and install into the top bearing.
14. Install the top bearing.
15. Install the retaining ring.

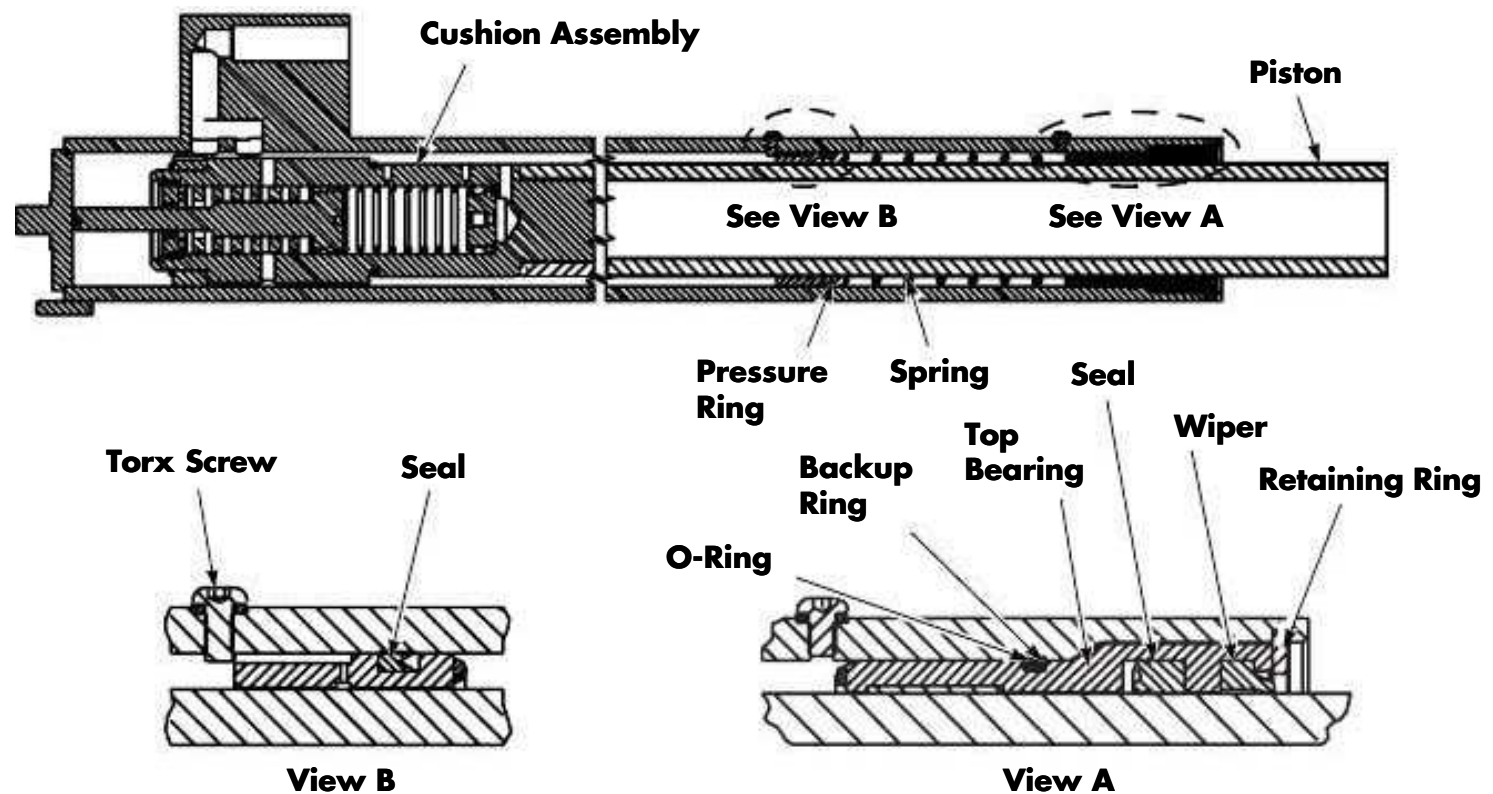

Figure 7-174. Center Lift Cylinder, Three-Stage with Cushions

Seal Replacement

Refer to [Figure 7-174](#) for the following steps.

1. Remove retaining ring and top bearing.

NOTE: When the retaining ring is removed, a spring behind the top bearing may push the bearing out of the housing.

2. Remove the spring and pressure ring.
3. Check to make sure the small orifice in the pressure ring is not obstructed.
4. Lightly oil a new seal and install in pressure ring.
5. Remove the bad parts from the top bearing.
6. Lightly oil new seal, O-ring, backup ring and wiper and install into the top bearing.
7. Install the top bearing.
8. Install the retaining ring.

2. Install cylinder. [See Side Lift Cylinder on page 7-84.](#)
3. Reconnect the battery connector and turn the key switch ON.
4. Bleed hydraulic system after reassembly. [See Bleeding Lift Cylinders on page 7-81.](#) Check for leaks.
5. Test all vehicle functions.

Installation

1. Reverse the removal procedure.

RAYMOND

Mast Section

Carriage

Removal

1. Turn the key switch OFF and disconnect the battery connector.
2. Remove operator console cover.
3. Remove electrical over-the-mast cable from bottom pulley on carriage. See [Figure 7-175](#).
4. Disconnect cable tension spring from carriage. See [Figure 7-175](#).

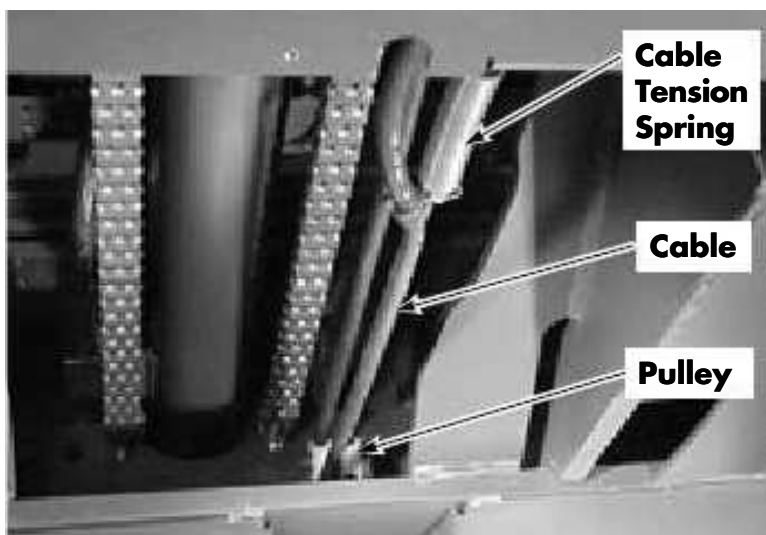

Figure 7-175. Electrical Over-the-Mast Cable

5. Disconnect JPC8 and JPC9 from carriage manager and cut cable tie from tractor side.

CAUTION

Do not place hands between the masts before blocking the carriage.

6. Feed cable through carriage to tractor.
7. Use 90° snap ring pliers to remove snap ring holding chain rocker assembly to center cylinder. See [Figure 7-176](#).

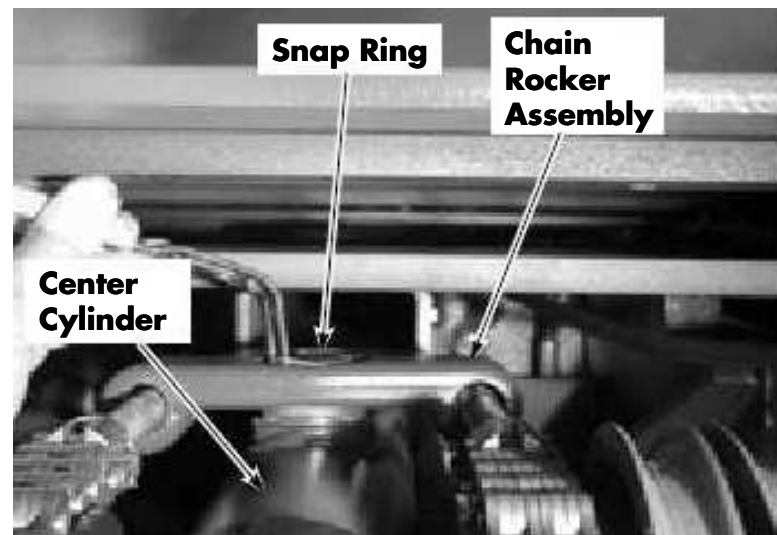

Figure 7-176. Center Cylinder, Top View

8. Attach a suitable hoist to carriage and lift approximately 1 ft. (30.5 cm).
9. Remove rocker assembly, its associated hardware and chain from center cylinder. Place chain on operator platform.
10. Remove end cap from center cylinder.
11. Remove carriage stops (2) from inner telescopic and pound in locator pins until carriage can clear the telescopic. See [Figure 7-177](#) and [Figure 7-178](#).

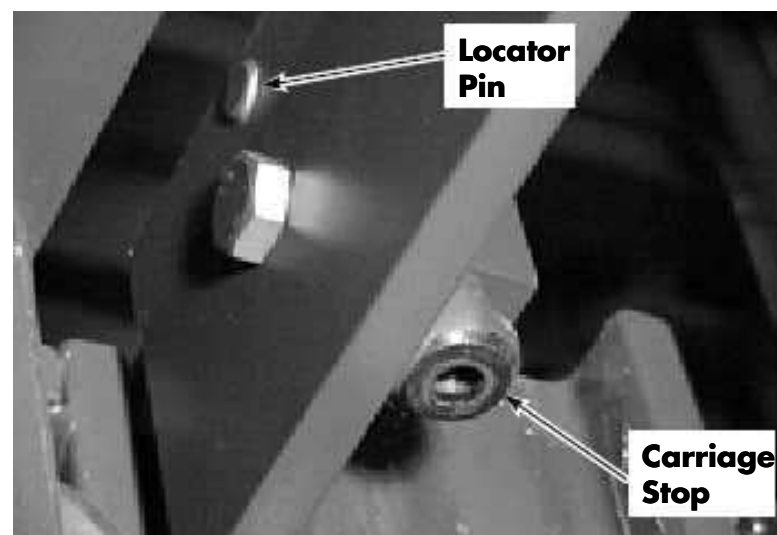

Figure 7-177. Inner Telescopic, Top Corner

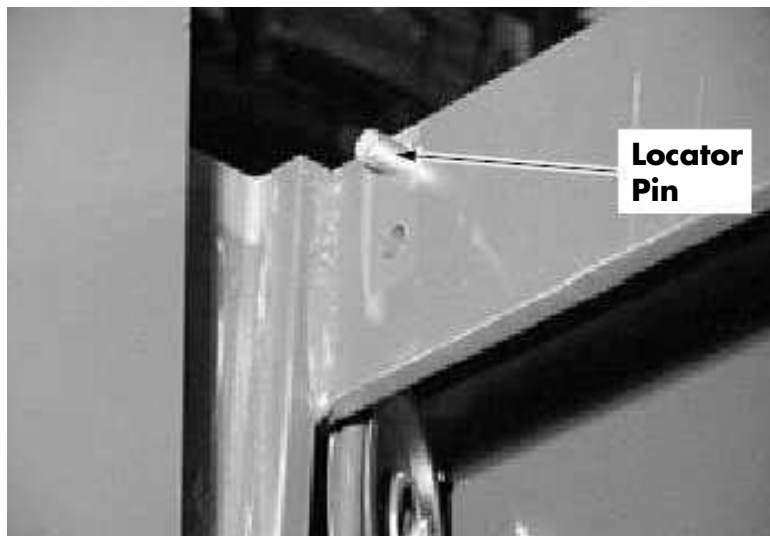

Figure 7-178. Inner Telescopic, Top Corner, Stops Removed

12. Remove operator platform.

Installation

1. With a suitable hoist, lower bottom bearings on carriage into channel on inner telescopic.
2. Make sure there are sufficient shims to prevent side play. See Mast Bearing Shimming on page 7-96.
3. Make sure the two switches (S36 and S37) at bottom of carriage are riding on their switch rail correctly. See Figure 7-179.

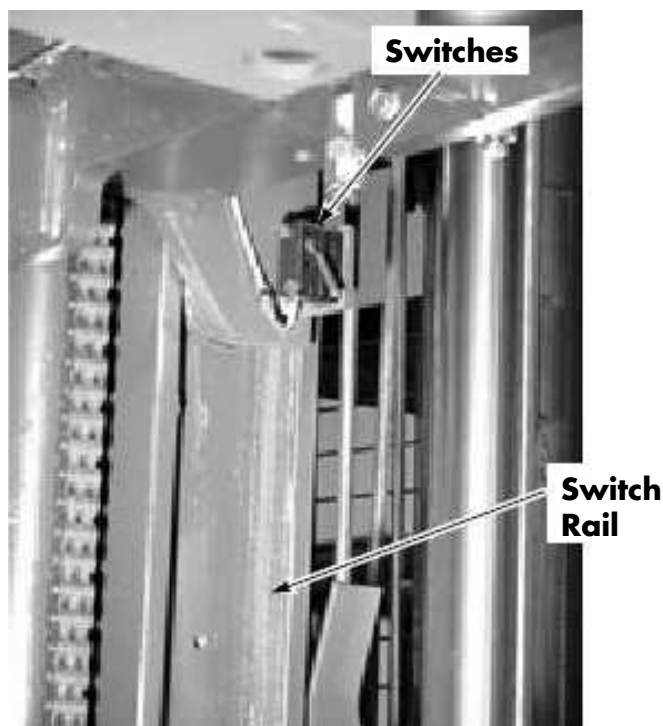

Figure 7-179. Underside of Carriage

4. Position platform 3 ft. (1 m) from floor.
5. Install rocker assembly, its associated hardware, and chain on center cylinder. See Figure 7-176.
6. Install end cap pulley on center cylinder.
7. Feed chains for center cylinder and over-the-mast cable.
8. Feed over-the-mast cable through back of carriage to carriage manager and connect to JPC8 and JPC9.
9. Use cable ties to secure electric cables to platform.
10. Install carriage stops at top of inner telescopic. See Figure 7-177.
11. Lower carriage and install cable on bottom pulley of carriage. Install cable retainer spring. See Figure 7-175.

NOTE: There is 5 1/2 in. (140 mm) from the top of the spring on the carriage to the center bolt in the cable clamp.

12. Install console cover.
13. Install mast guard.
14. Lift and lower platform fully, and check functions of lift system. Look for:
 - Hydraulic fluid leaks
 - Cables on pulleys
 - Switch actuation
 - Unusual bearing noise

Center Cylinder Ride Spring Chain Anchors

Inspect the chain anchors and pivot rocker any time that the chains are lubricated and adjusted.

Inspection

1. Remove the operator compartment console cover and tractor cover.
2. Lift the operator platform just high enough to have the chain anchor/pivot rocker visible through the opening under the operator control panel.
3. Place blocking under the operator platform. Lower the platform onto the support.
4. Turn the key switch OFF and disconnect the battery connector. Open the emergency lower valve.

The center cylinder will move down and the chains will go slack. If the center cylinder does not go down far enough to slacken the chains, push down on the top of the cylinder. This will allow the chain anchor to be visible for inspection. See Figure 7-180.

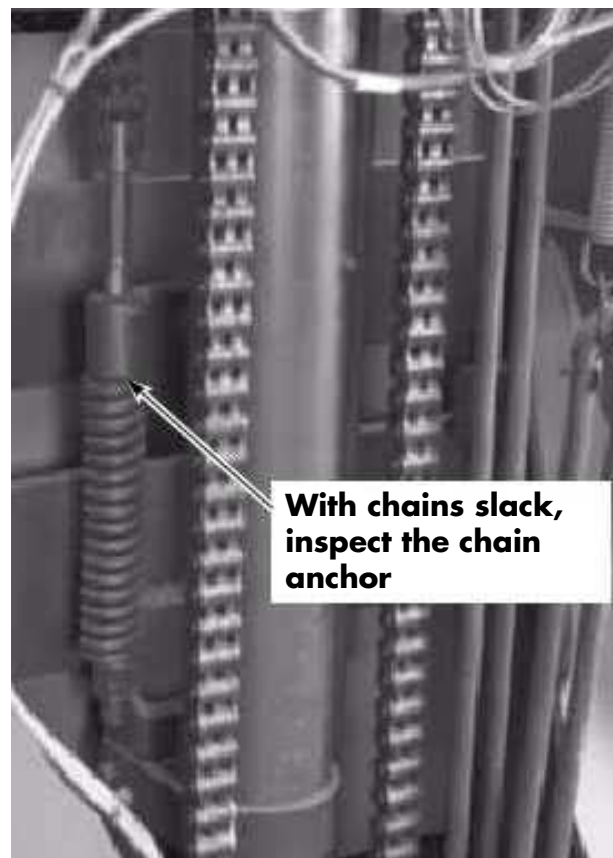

7

Figure 7-180: Chain Anchors

5. Inspect the chain anchor and pivot rocker for wear and replace if necessary.
6. Reconnect the battery connector and turn the key switch ON. Close the emergency lower valve.
7. Lift the platform *slowly* to take slack out of the chains and to clear the safety stand from beneath it.
8. Remove the stand and lower the platform.
9. Reinstall all covers.

Forks

Removal

1. Raise operator platform high enough to reach bottom of forks.
2. Block operator platform.
3. Secure fork to hoist using a suitable strap or chain. See Figure 7-181.
4. Remove socket head cap screw from underneath fork at tractor end.

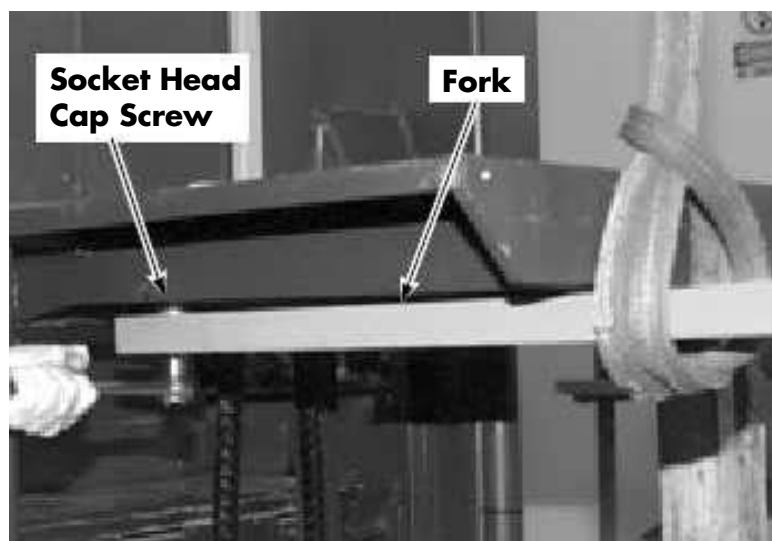

Figure 7-181. Fork Removal

5. Remove snap ring from pivot pin in mounting block of fork. See Figure 7-182.



Figure 7-182. Snap Ring, Pivot Pin, and Mounting Block

⚠ WARNING

The fork will drop in step 6. It weighs approx 150 lb. (68 kg).

6. Drive out pivot pin. The fork, washers, or shim will drop.
7. Replace damaged fork.

Installation

1. Hold new fork in place underneath operator platform.
2. Install pivot pin through fork.

NOTE: Always use new snap rings when assembling components.

3. Install new snap ring in pivot pin.
4. Install correct amount of washers or shims at back side of fork to maintain a level fork. See Figure 7-183.

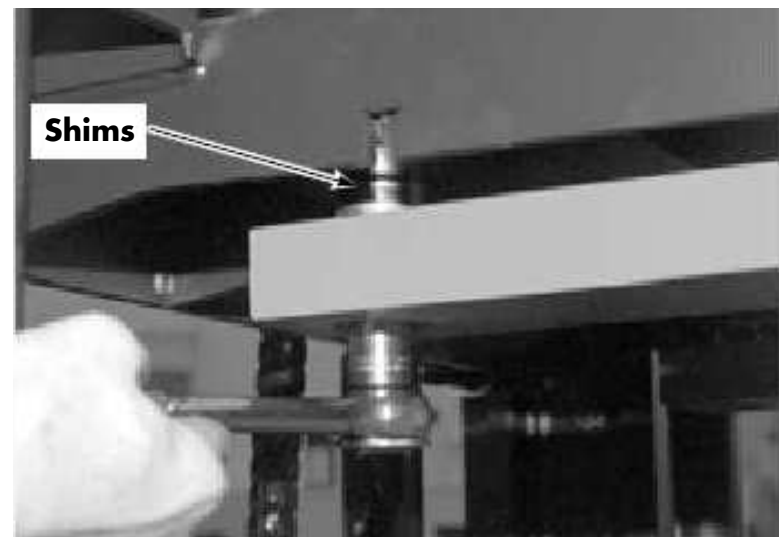

Figure 7-183. Installing Forks and Shims

5. Install socket head cap screw at tractor end of fork.
6. Remove block from operator platform.
7. Lower operator platform to floor and make sure forks are level. If forks are not level, add more shims to fork.

Mast Bearing Shimming

Shimming a mast is done to ensure a smooth running unit that is not too tight or too loose. Total movement between the bearings and telescopics must be between 0.030 to 0.045 in. (0.76 to 1.14 mm).

If any marks are found within the telescopics or main frame where the rollers have been running, they must be removed with a sanding disk with 80 grit paper. Do not attempt to remove all marks, only the ridges.

A correctly adjusted mast must show no more than a 0.5 in. (13 mm) mark where the roller touches the respective telescopic or main frame. The assembly must be shimmed to the tightest spot on the assembly (as the rollers run up and down the rail). Small areas that are slightly higher than the rest of the web can be buffed to avoid shimming the major portion of the rail too loose. While shimming the mast, the telescopics and carriage must be loose enough to slide them in and out by hand. Shimming the assembly in an upright position can result in shimming that is too tight and could cause premature wear.

The shims used under each roller bearing come in the following sizes: thin, medium, and thick. When the truck is built, the factory typically installs a thick shim on each side. If the bearings are too loose, you should add shims to the bearing. If the roller bearings are shimmed too tight, causing wear along the I-beam or mast shaving, reduce the shim thickness. Although different combinations of shims may be used to obtain the correct adjustment, you should try to maintain equal shim thickness on each side of the mast main frame and telescopics. See Figure 7-184.

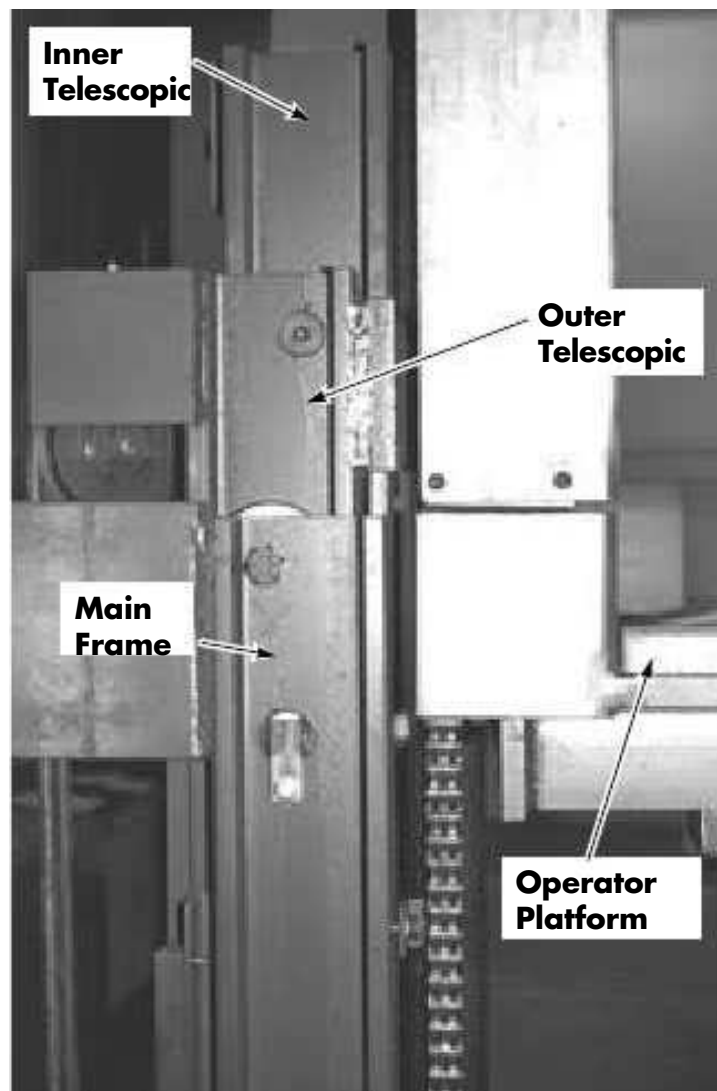

Figure 7-184. Staging of Mast Prior to Shimming Bearings

Steering System

Steering System

This section contains a description of the steering system. For wire guided steering information, refer to page 8-13.

System Components

- **Steering Request Encoder** – a dual encoder located behind the steer wheel on the carriage converts the operator request into electronic pulses
- **Carriage Control Card** - converts the inputs from the steering request encoder into a message sent to the Vehicle Manager
- **Vehicle Manager** - the controlling manager of the steering system. Generates commands to the steer amplifier based on the message from the Carriage Control Card
- **Steer Amplifier** - amplifies the steering commands from the Vehicle Manager and drives the steer motor
- **Electric Steer Motor/Gear Reducer** - positions the drive unit
- **Steer Motor Encoder** - located inside the steer motor and used to determine if the motor is responding to the commands of the VM
- **Home Sensor Prox** - used by the steering system to position the drive unit straight ahead during Auto Steer Center

System Overview

The Steering Request Encoder is attached to the steer tiller on the carriage. The Steering Request Encoder is a dual encoder. It contains two encoders in a single package.

Each encoder produces two channels that are quadrature phased and are used by the CCC to produce a steering request (steering count) that is sent to the VM over the communications bus. The VM, in turn, sends steering commands for either clockwise or counterclockwise rotation to the Steer Amplifier. The Steer Amplifier drives

the steering motor to obtain the movement that was requested from the tiller.

Both steering encoders in the dual encoder must be operational for full travel speed. If only one steering encoder is operational, travel speed is limited to 2.5 mph.

The VM monitors steer current (JPT6-3), the Steer Motor Encoder, and Neutral Pulse to determine that the steering system is operating correctly. The VM supplies +12VDC to the Steer Amplifier at JPT6-6 to power the circuits inside the Steer Amplifier. When the deadman is depressed, the VM energizes the TPC contactor, providing B+ to TP2 on the Steer Amplifier to power the steer motor.

Functional Description

The dual steering encoder is connected to the CCC at JPC1 (encoder 1) and JPC21 (encoder 2). Each encoder has a +5.3V supply, a DGND, two quadrature phased channels (CHA and CHB), and a jumper that is used as a connect detect to ensure that the steering encoder is connected to the CCC before normal operation of the truck is allowed by the VM.

When the tiller is moved, each encoder produces an output pair (CHA and CHB from encoder 1 and CHA-E2 and CHB-E2 from encoder 2). If the tiller is turned faster, the frequency of the output from the encoder increases. Each pair is converted into a positive or negative steering count that contains information on the direction and speed of the steering request from the tiller. This is sent over the communications bus to the VM. If either of the steering counts are missing, the VM will cause a steering code to be displayed;

- Code G0 if CHA/CHB is missing
- Code G7 if CHA-E2 / CHB-E2 is missing

When the VM receives the steering count from the CCC, it produces the appropriate steering command for the Steer Amplifier. This steering command is sent to the Steer Amplifier at JPT6-5 (CCW-PWM for CCW rotation) or JPT6-2 (CW-PWM for CW rotation). Although these commands are a PWM voltage, either can be

measured as a DC voltage with a Digital Multi Meter. The voltage will vary from approx. 11VDC when the steering tiller is stationary, and decreases as the steer tiller is moved faster. A slow request is represented by a voltage of about 9VDC and a fast request is represented by a voltage of approx. 5VDC measured with respect to (wrt) B-. Because the VM is monitoring both the steer motor current and the output from the Steer Motor Encoder, it knows that the steer motor moves when requested.

When the steer motor is not moving, there is no input to the VM from either the steer motor current or the steer motor encoder. This situation can occur when driving in a straight line. The VM needs a way to ensure the steer system is operational. This is accomplished through the Neutral Pulse. When the Steer Amplifier has an input at the CW-PWM line, it drives the Neutral Pulse output low (<0.5VDC). When the Steer Amplifier has an input on the CCW-PWM, it drives the Neutral Pulse high (>4VDC). When the deadman is depressed and there is no input on either the CW-PWM or the CCW-PWM lines, the VM dithers the CW-PWM and CCW-PWM control lines, causing the Neutral Pulse line to toggle between high and low states. The VM detects the Neutral Pulse is toggling as the CW-PWM and CCW-PWM lines vary, thereby ensuring the VM that the steering system is operational.

The connect detect jumper for encoder 1 is JPC1-8 and 9 and is called BRKDMAN/DEADMAN. If that jumper is open or JPC1 is disconnected, the hard wired voltage, BRAKE DEADMAN, from the CCC to the VM is interrupted and the VM will cause a Code 8C. If the jumper is intact and the encoder fails, the VM will lose steering encoder one and the VM will cause a Code G0.

The connect detect jumper for encoder 2 is JPC21-5 and 6 and is called CD SUPPLY/CD. This jumper connects a 5VDC supply to an input on the CCC processor. When the voltage is present, the CCC sends a message to the VM that the steering encoder is connected. If the voltage is not present, the message to the VM is that the encoder is not connected and the VM

causes a Code G7. If the jumper is intact and encoder 2 fails, the CCC will send a count for encoder 1 and not encoder 2, to the VM, and the VM will still cause a Code G7. Either failure will cause the same code.

Lift/Lower System

Lift/Lower System

Emergency Lower

Provisions are made to lower the carriage from the ground. When the Emergency Lower Valve is opened, hydraulic fluid is allowed to pass through the emergency lower valve at a constant rate.

Variable Speed DC Lift with *intellispeed*[®]

NOTE: For trucks without *intellispeed*, all functions are the same excluding references to the flow sensor, *intellispeed* manager, and height counts.

The CCC is constantly monitoring the output voltage of VR2 and sending it to the VM over the BUS. The VM compares this voltage to the voltages stored during the Learn process. The VM checks the battery voltage (for lift cutout), all enabled options and switches that could prevent the activation of the lift system. When satisfied that no criteria are present to prevent lift, it then determines the requested percentage of full speed lift. It then activates the lift/lower proportional valve fully open and closes the lift pump contactor by taking the coils to B-.

Opening the lift/lower valve fully prevents sudden movement of the platform when the lift pump is first activated by allowing the fluid to return to the tank. As soon as the command to close the P contactor is activated, the VM looks at the P Sense input, verifying the contactor closed as commanded. It then slowly reduces the PWM output to the coil for the lift/lower proportional valve to match the percentage of full speed lift requested. As the lift/lower proportional valve closes, hydraulic fluid passes through the 5 psi check valve, the normally closed check valve in the load holding valve, through the flow sensor to the flow controls at the bottom of the lift cylinders. The flow control in the center cylinder allows unrestricted fluid flow to the center lift ram. The center ram elevates first because less pressure is required. Once the platform hits the stops on the inner telescopic, the pressure increases enough to

start elevating the side cylinders. Oil flow spins the turbine in the flow sensor. As the turbine spins, the vanes pass by the magnetic pickups screwed into the flow sensor housing. This creates a series of high and low pulses (or counts) that go into the flow sensor module. The pickups are 90° out of phase. This allows the system to determine if the carriage is elevating or lowering, based on the direction the vanes are spinning. The flow sensor module passes these counts to the VM. The VM determines the direction of travel and the number of counts. The VM uses this information to calculate fork height, which it uses to determine speed reductions at elevated height.

When the VM first commands the activation of the lift system, it is looking for the feedback from the flow sensor. If the lift is commanded to activate and no counts from the flow sensor are present, the VM will flag an error condition and assume it is at maximum elevated height for speed limiting. Travel speed is reduced linearly by about 0.5 mph for every 18 in. from full speed down to 1 mph, between the lower reference switch and 240 inches. A low volume of fluid flow will not cause the turbine to spin. Because of this, if the lift system is feathered often, an error is registered. If the *intellispeed* option is not on the truck, the travel is reduced each time a mast limit switch is opened while elevating.

The VM monitors the P Sense line to determine the condition of the P contactor and verify the lift motor is spinning. When a lift request has finished (VR2 has either returned to neutral or through neutral to a lower request), the VM monitors the P Sense line for back ElectroMotive Force (EMF) from the motor to determine that the lift motor has stopped spinning. As long as the VM senses voltage on the P Sense line, it will provide voltage to the lift/lower proportional coil, keeping the valve open to allow the fluid from the pump to return to tank. This ensures the cylinders do not continue lifting after the request has ended. Once the lift motor has completely stopped spinning, the VM will remove voltage to the lift/lower coil, closing the lift/lower proportional valve.

24V Trucks With Hi-Pro Option

24V trucks with the Hi-Pro Option have a two stage lift pump. This lift pump has a 2nd stage select solenoid on the bottom of the pump. This solenoid is activated whenever there is less than 1000 lb. (454 kg) on the forks. When activated, the fluid from the second pump is ported to the lift system to increase lift speed. The weight calculation is done with either a pressure transducer or a pressure switch (trucks without *intellispeed*[®]) located on the hydraulic manifold. The input from the pressure switch goes directly to the VM and activates a circuit to turn off the 2nd stage select solenoid. On trucks with the pressure transducer, the VM calculates the weight and turns off the solenoid when a reading of 1000 lb. (454 kg) or more is registered.

Variable Speed AC Lift with *intellispeed*

NOTE: For trucks without *intellispeed*, all functions are the same excluding references to the flow sensor, *intellispeed* manager, and height counts.

The CCC is constantly monitoring the output voltage of VR2 and sending it to the VM over the BUS. The VM compares this voltage to the voltages stored during the Learn process. The VM checks the battery voltage (for lift cutout), all enabled options, and all switches that could prevent the activation of the lift system.

When satisfied that no criteria are present to prevent lift, the VM then determines the requested percentage of full speed lift. It then sends an RPM command over the BUS to the Lift Power Amplifier. The LPA activates the LPC contactor by taking the coil to B- internally in the LPA. As soon as the command to close the P contactor is activated, the LPA looks at the (+) input from the LPC verifying the contactor closed as commanded. It then slowly increases the voltage output to the lift motor to match the RPM requested. As the voltage is increased to the lift motor, the motor and pump spin faster, increasing the output of oil to the lift system.

The LPA monitors the input from the bearing encoder in the lift motor and determines the RPM of the motor. It adjusts the output to the motor to maintain the requested RPM. The hydraulic fluid passes through the 5 psi check valve, the normally closed check valve in the load holding valve, through the flow sensor to the flow controls at the bottom of the lift cylinders. The flow control in the center cylinder allows unrestricted oil flow to the center lift ram. The center ram elevates first because less pressure is required. Once the platform hits the stops on the inner telescopic, the pressure increases enough to start elevating the side cylinders. As the lift cylinders start to elevate, the fluid flow starts to spin the turbine in the flow sensor once the volume is large enough. As the turbine spins, the vanes pass by the magnetic pickups screwed into the flow sensor housing. This creates a series of high and low pulses (or counts) that go into the flow sensor module. The pickups are 90° out of phase. This allows the system to determine if the carriage is elevating or lowering, based on the direction the vanes are spinning. The flow sensor module passes these counts to the VM. The VM determines the direction of travel and the number of counts. The VM uses this information to calculate the fork height that it uses to determine speed reductions at elevated height. When the VM first commands the activation of the lift system, it is looking for the feedback from the flow sensor. If the lift is commanded to activate and no counts from the flow sensor are present, the VM will flag an error condition and assume it is at maximum elevated height for speed limiting. Travel speed is reduced linearly, about 0.5 mph every 18 in., from full speed down to 1 mph, between 60 and 240 inches. A low volume of fluid flow will not cause the turbine to spin. Because of this, if the lift system is *feathered* often, an error is registered. If the *intellispeed* option is not on the truck, the travel is reduced each time a mast limit switch is opened.

the outer coils (Guidance Coils) on both the tractor end and the load end sensors as the truck begins to align over the wire. When the voltages that the truck detects from the load end and tractor end guidance coils begin to balance out and match the Learned Offset values for those coils, the Guidance Card will switch from Aligning Mode to Locked on Wire or Guided Mode. At that time, all of the wire guidance icon LEDs on the Carriage Light Display Card will illuminate solid and full travel speed is allowed in either direction.

The Guidance Card constantly monitors the voltages from each of the four guidance coils via the Filter Card. It compares the voltage from each coil to the value for each coil that was obtained through the Learn procedure. By comparing the actual values for all four guidance coils with the learned values stored in the memory, the Guidance Card can issue the appropriate steering commands to the VM to keep the truck centered over the guide wire. Also, using these values, the Guidance Card calculates the Heading Angle (HA - angle of the truck to the wire) and the Distance From Wire (DFW - how far the truck is from the wire) and issues the appropriate Slow or Stop commands to the VM when DFW or HA values set in Configure Mode are exceeded. See Table 3-2, "Configure Mode Menu," on page 3-13.

End-of-Aisle Control

The End-of-Aisle system consists of truck mounted components and magnets embedded in the floor inside of the aisle. The truck mounted hardware consists of four magnet sensors mounted between the baselegs under the operator's platform. They are connected directly to the VM. When the system is activated, the VM monitors the inputs from the sensors. When entering the aisle and both sensors cross a magnet in less than 24 in. (610 mm), the VM recognizes this as In-Aisle-State. This information is stored in Non Volatile Memory (NVM). NVM cannot be changed by a loss of power to the system. The only way to change it is by another input. This input can only be initiated by crossing another set of magnets or by traveling and turning the steering more than 10°. This allows the truck to

be powered down inside the aisle and remember that it is in an In-Aisle-State when powered back up. System operation is not changed upon aisle entry.

When the truck is exiting an aisle and each sensor is activated by magnets within 10 in. of each other, the truck will plug to reduce speed until the speed is reached that is stored in the Configuration Menu. Once this speed is reached, travel speed is limited by the VM to the speed programmed in the Configuration Menu until the control handle is returned to neutral and travel is requested again. During the plugging sequence, the operator can override the plugging strength with a request for a more aggressive plug from the control handle. When the sensors are activated by magnets that are more than 11 in. (279 mm) but less than 30 in. (762 mm) apart, the VM plugs the truck to a complete stop. The operator must then return the control handle to neutral and request travel again.

End-of-Aisle Configurations

Figure 8-1 shows the various EOA configurations possible within a system.

End-of-Aisle Magnet Installation Information

If there are consistent, repetitive problems with end-of-aisle operation, and the truck appears to be OK, the magnets may have been installed out of tolerance. Figure 8-2 and Figure 8-3 depict the correct location of the magnets.

System Overview

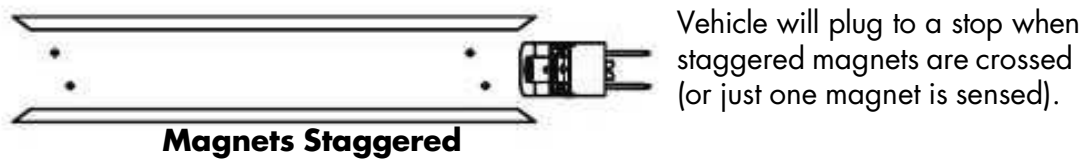
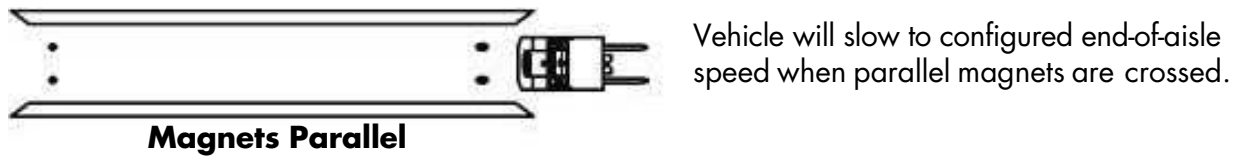

Vehicle will slow to configured end-of-aisle speed when parallel magnets are crossed.

Vehicle will plug to a stop when staggered magnets are crossed (or just one magnet is sensed).

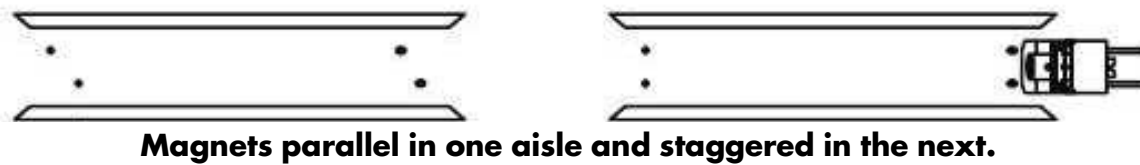

Vehicle will slow to configured speed in aisle that has parallel magnets and plug to a stop in aisle that has staggered magnets.

Figure 8-1. End-of-Aisle Configurations

8

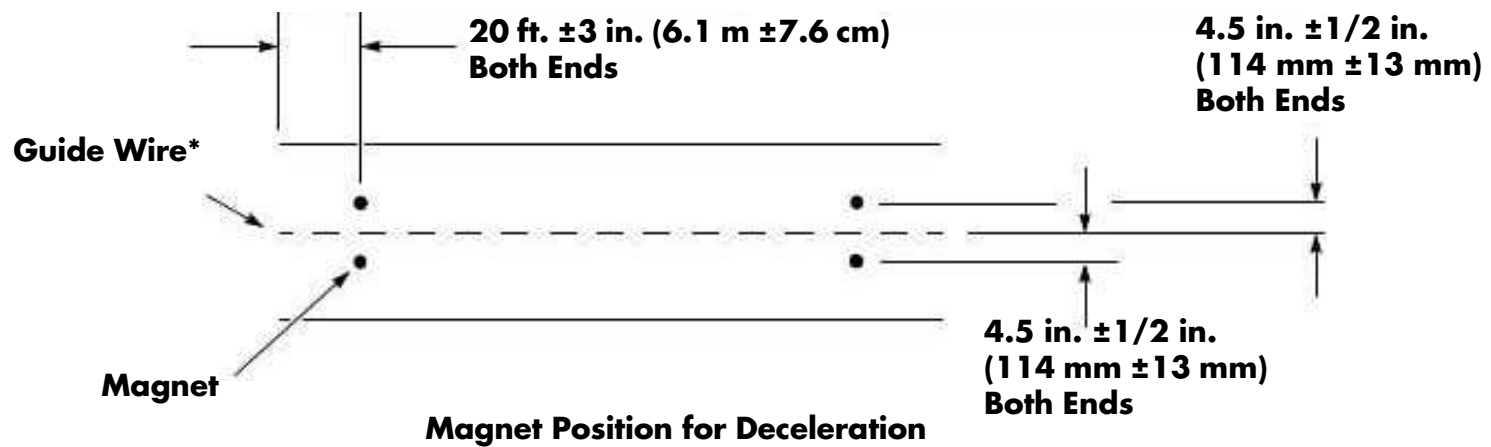

* In rail guided applications, use the center of the aisle as the reference point for the dimensions.

Figure 8-2. End-of-Aisle Magnet Position (Deceleration)

8

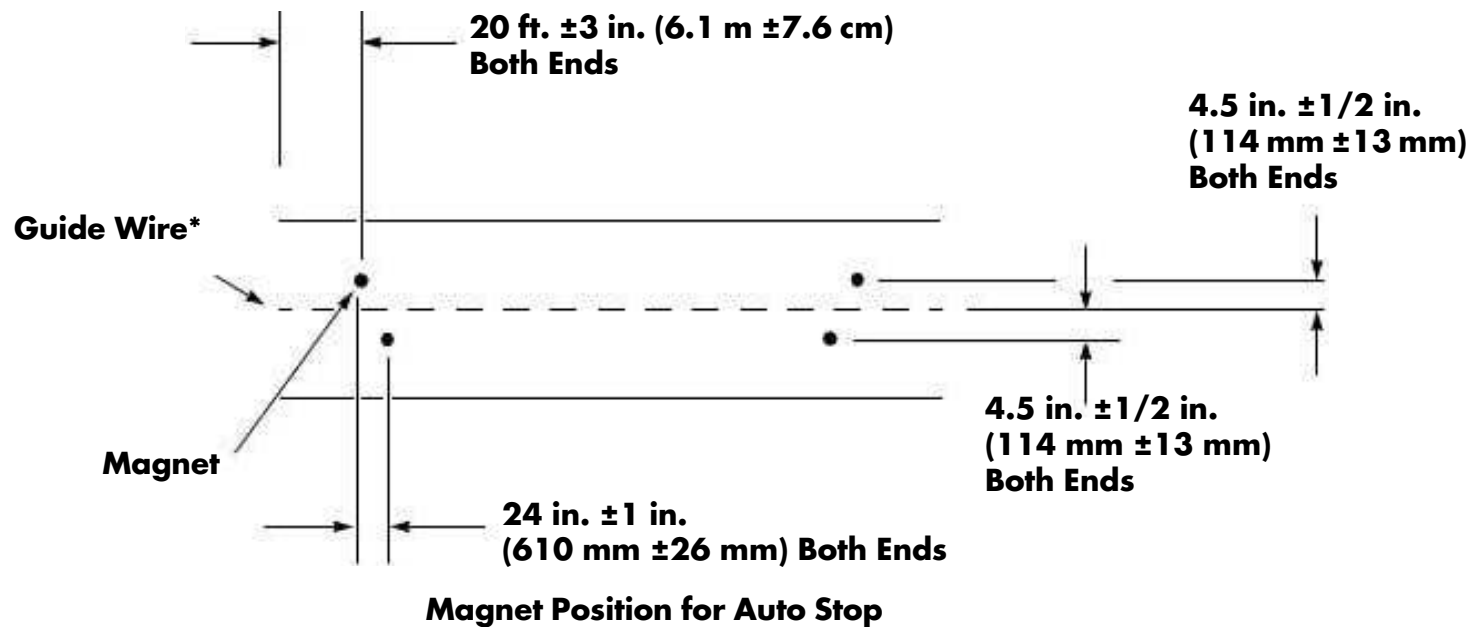

***In rail guided applications, use the center of the aisle as the reference point for the dimensions.**

Figure 8-3. End-of-Aisle Magnet Position (Auto Stop)

8

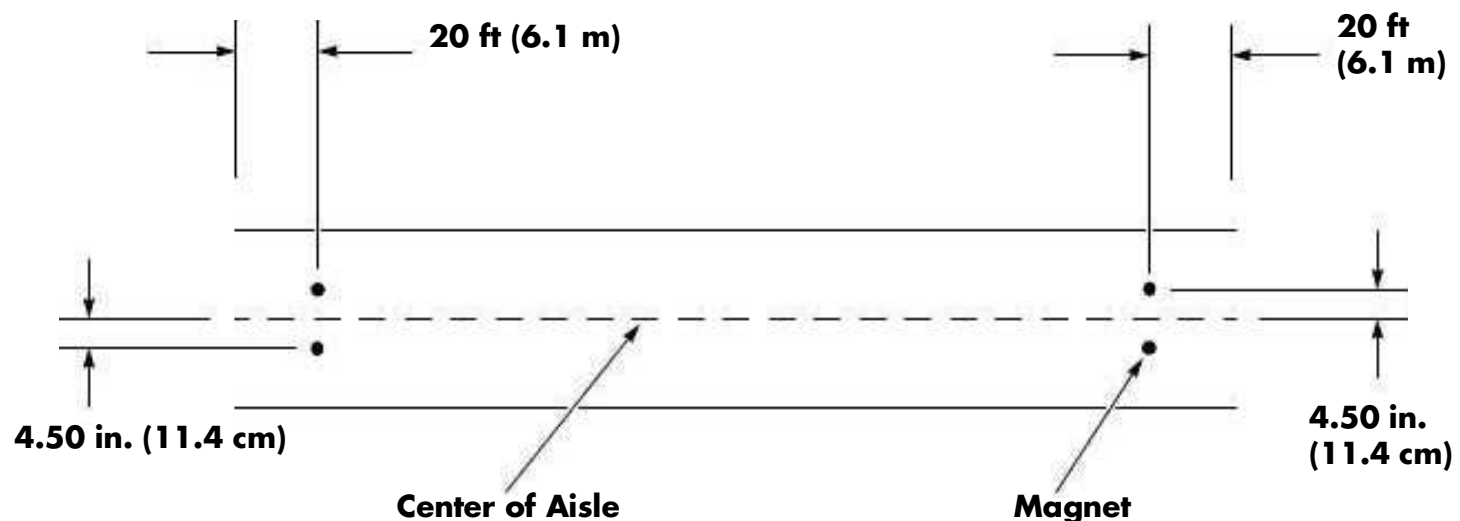

Figure 8-4. End of Aisle Magnet Location

8

End-of-Aisle Slow Down

With Wire Guidance

When the truck is locked on the guide wire, the VM will start looking for the input from the magnet sensors. When a set of magnets is crossed entering the aisle, the system functions as described in End-of-Aisle Control. If the magnets are crossed while exiting the aisle with the AUTO/MANUAL switch in the AUTO position, the truck will slow down or stop;

whichever the system is configured for. If the AUTO/ MANUAL switch is moved to the MANUAL position prior to crossing the magnets, the system will not look for the magnets. Steering is reverted to the operator and normal operation is resumed. Once out of the aisle and the steering is turned more than 10° while traveling, the aisle state is reset to out-of-aisle.

End-of-Aisle Slow Down

With auto steer center in a rail guided system WITH a rail switch installed on one guide roller assembly.

When the truck enters the rails, the switch mounted on the guide roller assembly is closed. When the switch is activated, a tone will sound and the truck is speed limited until the AUTO/MANUAL switch is placed in the AUTO position. When the switch is placed in the AUTO position, the drive unit auto steer centers and steering control is taken away from the operator. The speed restriction is removed and full speed travel is allowed. The VM then starts looking for floor magnet inputs. When exiting the aisle, if the magnets are crossed with the AUTO/MANUAL switch in the AUTO position, the truck will slow down or stop, depending on system configuration. If the AUTO/MANUAL switch is moved to the MANUAL position prior to crossing the magnets, the system will not look for the magnets. Steering is reverted to the operator and normal operation is resumed. An audible tone sounds until either the AUTO/MANUAL switch is turned back to AUTO or the rail switch on the guide roller opens. Once out of the aisle and the steering is turned more than 10° while traveling, the aisle state is reset to out-of-aisle.

With auto steer center in a rail guided system WITHOUT a rail switch installed on the guide roller assembly.

When the truck is in the aisle and the AUTO/MANUAL switch is in AUTO, the VM will start looking for the input from the magnet sensors. When a set of magnets is crossed entering the aisle, the system functions as described in “End-of-Aisle Control” on page 8-15. When exiting the aisle, if the magnets are crossed with the AUTO/MANUAL switch in either position, the truck will slow down or stop, depending on how the system is configured.

Pin-Out Matrix

Item	Connection	Function Description	Theory of Operation	Normal Level	Signal Source	Signal User
43	JPC9-6	L/L	Variable voltage from VR2 wiper. The CCC monitors this voltage and sends it to the VM. Voltage must be between 0.4 and 4.6V. If not, Code 81 is displayed.	1.3V Neutral: 0.4V Full Lift: 2.1V Full Lower	CCC	CCC
44	JPC9-7	DGND	B- for VR1.	<0.3V wrt TP4	VM	VR1
45	JPC9-8	+5.3V	Supply voltage for VR1 (Travel Pot).	>5V	CCC	VR1
46	JPC9-9	TRAVEL	Variable voltage from VR1 wiper. The CCC monitors this voltage and sends it to the VM. Voltage must be between 0.4 and 4.6V. If not, Code 80 is displayed.	1.3V Neutral; 0.8V Full Fwd: 2.6V Full Rev	CCC	CCC
47	JPC9-10	Not Used				
48	JPC11-1	+12VF	Supplies working voltage to the CCC.	10.8-13V w/key switch ON	VM	CCC
49	JPC11-2	BUS-	Carries the negative component of the digital communications between the CCC and the managers on the tractor side of the communications bus.	2.0V	CCC	LPA, TPA and VM
50	JPC11-3	BUS+	Carries the positive component of the digital communications between the CCC and the managers on the tractor side of the communications bus.	3.0V	CCC	LPA, TPA and VM
51	JPC11-4	BRAKE DEADMAN	Sent by the CCC to the VM to energize the brake when all other conditions are met. This output is sent when S2 is closed.	>6V with deadman up and brake applied; <0.5V with deadman down and brake released	CCC	VM
52	JPC11-5	CARRIAGE DEADMAN	Sent by the CCC to the VM to energize the brake when all other conditions are met. This output is sent when S23 is closed.	>6V with deadman up and brake applied; <0.5V with deadman down and brake released	CCC	VM
53	JPC11-6	DGND	Reference and negative for the circuits on the CCC. Although it eventually connects to B-, it is kept separate from the other grounds to help reduce the effects of noise on system operation.	<0.3V wrt TP4	VM	CCC
54	JPC12-2	B-F SPARE	B- for Security Start Switch Relay.	B-	CCC	K2 Relay for Security Start Switch

Pin-Out Matrix

Item	Connection	Function Description	Theory of Operation	Normal Level	Signal Source	Signal User
55	JPC13-2	+12VF	12V supply to S61 (Left Sidegate Switch).	10.8-13V w/key switch ON	VM	CCC
56	JPC13-1	SIDEGATE LEFT	Output from S61 used by the CCC to detect the position of the left sidegate. The VM will prohibit travel if the sidegate is up or the switch is open.	10.8-13V w/key switch ON	VM	CCC
57	JPC13-3	PGND	B- for S61.	<0.3V wrt TP4	VM	CCC
58	JPC14-1	SIDEGATE RIGHT	Output from S60 used by the CCC to detect the position of the right sidegate. The VM will prohibit travel if the sidegate is up or the switch is open.	<1V with sidegate down: approx. 10V w/sidegate up	S60	CCC
59	JPC14-2	+12VF	12V supply to S60 (Right Sidegate Switch).	10.8-13V w/key switch ON	VM	S60
60	JPC14-3	PGND	B- for S60.	<0.3V wrt TP4	VM	CCC
61	JPC15-1	Not Used				
62	JPC15-15	DGND	B- for the Carriage Control Light Display Card.	<0.3V wrt TP4	VM	Light Display Card
63	JPC15-16	5.3V	Supply voltage for the Carriage Control Light Display Card.	>5V	CCC	Light Display Card
64	JPC15-24	Not Used				
65	JPC16-1	B+EPO	Present when both the Key Switch and EPO switch are closed. Supplies B+ Estop to the Fuse/Relay Card where it is used by the K1, K2, and K3 relays.	B+	CCC	Fuse/Relay Card
66	JPC16-2	B-FUSED	B- for the Spare Power Connector (JPC12-2) on the CCC. Supplies B- for the optional lights, fan, and RF unit.	<0.3V wrt TP4	Fuse/Relay Card	CCC
67	JPC16-3	B+FUSED	B+ for the Spare Power Connector (JPC12-1) on the CCC. Supplies B+ for the optional lights, fan, and RF unit.	B+ wrt TP4 w/battery connected	Fuse/Relay Card (FU7)	CCC
68	JPC16-4	B-FUSED	B- for the CCC from the Fuse/Relay Card.	<0.3V wrt TP4	Fuse/Relay Card (FU6)	CCC
69	JPC16-5	B+EPO	B+EPO Spare.	B+	CCC	Spare
70	JPC16-6	B+KEY	B+ that is switched by the Key Switch (S1) and sent from the CCC to supply B+ Key to the Fuse/Relay Card.	B+ w/S1 closed	CCC	Fuse/Relay Card
71	JPC16-7	B+FUSED	B+ Fused Spare.	B+	CCC	Spare
72	JPC16-8	B+FUSED	Main B+ supply to the CCC and is fused through FU5 on the Fuse/Relay Card.	B+ wrt TP4	Fuse/Relay Card	CCC

Pin-Out Matrix

Item	Connection	Function Description	Theory of Operation	Normal Level	Signal Source	Signal User
73	JPC21-1	+5.3V	Supplies +5.3V to the E2 Steering Request Encoder. It is dependent on the +12VP from the VM at JPC11-1.	>5V	CCC	E2 Steering Request Encoder
74	JPC21-2	DGND	B- for the circuits of the E2 Steering Request Encoder.	<0.3V wrt TP4	CCC	E2 Steering Request Encoder
75	JPC21-3	CHB-E2	One part of the steering request from the E2 Steering Request Encoder when the steering tiller is moved. It is a square wave signal (0V and 5V) identical to CHA-E2 but different phase. The CCC sends this information to the VM.	0-5V nominal w/tiller moving: >4.5V or <0.5V w/tiller stationary	E2 Steering Request Encoder	E2 Steering Request Encoder
76	JPC21-4	CHA-E2	One part of the steering request from the E2 Steering Request Encoder when the steering tiller is moved. It is a square wave signal (0V and 5V) identical to CHB-E2 but different phase. The CCC sends this information to the VM.	0-5V nominal w/tiller moving: >4.5V or <0.5V w/tiller stationary	E2 Steering Request Encoder	E2 Steering Request Encoder
77	JPC21-5	CD SUPPLY	5.3V output from the CCC power supply. This voltage is dependent on +12VP from the VM at JPC11-1. This voltage goes back to the CCC microprocessor to let the CCC know that JPC21 is connected. If not connected, Code G0 is displayed.	>4V	E2 Steering Request Encoder	CCC
78	JPC21-6	CD	+5.3V output from the CCC power supply. This voltage is dependent on +12VP from the VM at JPC11-1. This voltage goes back to the CCC microprocessor to let the CCC know that JPC21 is connected. If not connected, Code G0 is displayed.	>5V	E2 Steering Request Encoder	CCC
79	JPF1-1	B-	B- for FU8 (15A/5A) Fuse for optional Aux power.	<0.5V	TP4	Aux Power
80	JPF1-2	B-	B- for FU8 (15A/5A) Fuse for optional Aux power.	<0.5V	TP4	Aux Power
81	JPF1-3	Not Used				
82	JPF1-4	B-F	B-F from FU8 for optional Aux Power.	<0.5V	FU8 to B-	Aux Power
83	JPF1-5	Not Used				

Pin-Out Matrix

Item	Connection	Function Description	Theory of Operation	Normal Level	Signal Source	Signal User
84	JPF1-6	B+F or B-F	Provides either B+F or B-F to B+K3 on the Lift and Travel Power Amplifiers. At Startup the K3 coil is energized, providing B+ to the pre-charge circuit and logic circuits in the power amplifiers. With the K3 coil de-energized, JPF1-6 is at B- to discharge the amplifier precharge circuits.	B- w/K3 De-energized; B+ w/K3 Energized	FU5 when K3 is energized; FU6 when K3 is de-energized	LPA and TPA
85	JPF2-1	B+K2	B+ that is present when the K2 relay tips close (DC lift only).	B+ w/K2 closed	Fuse/Relay Card	LPC Coil
86	JPF2-2	B+ K2	B+ K2 to power the horn.	B+ with K2 energized	K2 tips	Horn
87	JPF2-3	B+K2	B+ K2 when the K2 relay tips are closed.	B+	K2 tips	VM
88	JPF2-3	B+K2	B+ supplied to the Aux Mast solenoids.	B+	Fuse/Relay Card	Aux Mast Solenoids
89	JPF2-4	Not Used				
90	JPF2-5	B+K2	B+K2 to power Load Holding Solenoid.	B+ with K2 energized.	K2 tips	L/H Sol.
91	JPF2-6	B+K2	B+K2 when the K2 relay tips are closed.	B+	K2 tips	VM
92	JPF2-7	B+K2	B+K2 when the K2 relay tips are closed.	B+	K2 tips	VM
93	JPF2-8	N/A				
94	JPF2-8	B+K2	B+ supplied to the 2 Stage Select Solenoid.	B+	Fuse/Relay Card	2 Stage Select Sol.
95	JPF2-9	B+KEY	B+ Key for warning light when K1 tips are closed.	B+	CCC	Warning Light
96	JPF3-1	B-	B- for FU6 (15A) that provides B- to the Vehicle Manager.	<0.5V	TP4	VM
97	JPF3-2	B-	B- for FU6 (15A) that provides B- to the Vehicle Manager.	<0.5V	TP4	VM
98	JPF3-3	B-F	B-F for DGND on the VM.	<0.5V	FU6	VM
99	JPF3-4	B-F	B-F for DGND on the VM.	<0.5V	FU6	VM
100	JPF3-5	B-F	B-F for the VM.	<0.5V	FU6	VM
101	JPF3-6	B-F	B-F for the VM.	<0.5V	FU6	VM
102	JPF3-7	B-F	B-F for the VM.	<0.5V	FU6	VM
103	JPF3-8	B-F	B-F for S10 (150 or 120 In. Limit Switch) on the mast.	<0.5V	FU6	S10
104	JPF3-9	B-F	B-F for wire guidance.	<0.5V	Fuse/Relay Card	Guidance Manager

Pin-Out Matrix

Item	Connection	Function Description	Theory of Operation	Normal Level	Signal Source	Signal User
220	JPT24-9	DGND	Return path for S47A and S47B (Aisle Detect Sensors).	<0.5V	S47A and S47B	VM
221	JPT24-10	DGND	Return path for Pressure Transducer A.	<0.5V	Pressure transducer	VM
222	JPT24-11	DGND	Return path for the Intellispeed Flow Sensor.	<0.5V	Flow Sensor	VM
223	JPT24-16	SLACK SW2	Input to the VM from S30 (Slack Chain Switch #2).	<1V closed: >9V open	Slack SW2	VM
224	JPT24-18	P/T_A	Analog DC voltage that varies directly with the weight on the carriage. Approx. 0.5V per 1000 lbs. It is necessary to have the VM supply approx. 12V as well as DGND in order for the transducer to function correctly.	1V with forks fully lowered	Pressure Transducer	VM
225	JPT24-19	FS_TEMP	Variable voltage that is representative of the temperature of the fluid in the lift system.	0.2-4.86V, approx. 3.2V @86°F	Flow Sensor	VM
226	JPT24-24	BATTERY_SENSE_IN	B+ present when the battery is plugged in. It is supplied through a thermistor on the Relay Control Fuse Panel. This is used by the VM to determine that the correct battery is connected. It will accept between 28 and 45V (36V Battery) or 18 and 30V (24V Battery). If the correct battery is sensed, Relay Enable is energized during start-up. After start-up, this voltage is used to determine BSOC.	B+ (there should be no voltage drop)	TP1	VM
227	JPTA1-1	B+K3	B+ present when K3 is energized. This is used to power the control circuits of the TPA.	B+ w/K3 energized	K3	TPA
228	JPTA1-6	TPC CONTACTOR	Control path for the TPC. The TPA supplies a path for B- for the contactor by way of the B- terminal.	TPC de-energized: B+ energized: 14.7V	TPA	TPC
229	JPTA1-7	DGND	Return path for the bearing encoder in the traction motor.	<0.5V	Travel Velocity Sensor	TPA
230	JPTA1-8	T TEMP+	Analog voltage that varies with the drive motor temperature. Used by the TPA to adjust motor performance.	Approx. 1V @75°F (24°C)	Traction Motor Temp.Sensor	TPA
231	JPTA1-11	ID0	Not Used by the Traction Power Amp.			
232	JPTA1-12	ID1	B+ present at the TPA with K3 tips energized. It is used as an identifier to determine correct connection.	B+ w/K3 energized	K3	TPA

Pin-Out Matrix

Item	Connection	Function Description	Theory of Operation	Normal Level	Signal Source	Signal User
233	JPTA1-13	B+KB	B+ for the TPC. The TPA supplies B+ for the TPC.	B+	TPA	TPC
234	JPTA1-14	Not Used				
235	JPTA1-23	BUS+	The wire that carries the positive component of the digital communications between the TPA, the VM, and the CCC.	3V	CCC	TPA, LPA, VM
236	JPTA1-25	Not Used				
237	JPTA1-26	T VEL SENSOR +	5V supply to the bearing encoder on the traction motor. This voltage is produced by the traction power amp from B+K3.	4.95V	TPA	Travel Velocity Sensor
238	JPTA1-28	Not Used				
239	JPTA1-29	Not Used				
240	JPTA1-31	T VEL PHASE A	This is generated when there is movement of the bearing encoder in the drive motor. It is a square wave that is either high (>3V) or low (<1V). The frequency varies directly with the speed of the drive motor. Identical to T VEL Phase B, except for phase. The TPA uses the relationship between phase A and B to determine travel speed and direction.	Motor Stationary: 4.06 or 0.03V: Turning: 2.3V	Travel Velocity Sensor	TPA
241	JPTA1-32	T VEL PHASE B	This is generated when there is movement of the bearing encoder in the drive motor. It is a square wave that is either high (>3V) or low (<1V). The frequency varies directly with the speed of the drive motor. Identical to T VEL Phase A, except for phase. The TPA uses the relationship between phase A and B to determine travel speed and direction.	Motor Stationary: 4.06 or 0.03V: Turning: 2.3V	Travel Velocity Sensor	TPA
242	JPTA1-33	BUS-	The wire that carries the negative component of the digital communications between the TPA, VM, and the CCC.	2.3V	CCC	TPA, LPA, CCC
243	JS27-2	O.T.M. Cable	Spare over-the-mast wire for future option.	B-	VM	Option
244	LPA (+)	LPA +	B+ to the LPA used to produce the AC phases U,V, and W when the LPC is closed to power the lift motor.	B+ with LPC closed	LPC	LPA
245	LPA (-)	LPA B-	B- from TP4 on the power panel. It is used for the power circuits on the LPA. Without B-, U, V, and W cannot be produced and the lift motor will not turn.	<0.5V	TP4	LPA

Pin-Out Matrix

Item	Connection	Function Description	Theory of Operation	Normal Level	Signal Source	Signal User
246	LPA (U)	Lift Motor Phase U	One of three phases from the LPA to the Lift Motor. This AC voltage is produced by the LPA and is dependent on B+ at the + terminal and B- on the LPA. This AC voltage is measured between any two phases and varies from 0VAC at rest to about 24VAC at full RPM.	VAC between two phases: Stationary: 0VAC Full Travel: 24VAC Stall: approx. 4VAC	LPA	Lift Motor
247	LPA (V)	Lift Motor Phase V	One of three phases from the LPA to the Lift Motor. This AC voltage is produced by the LPA and is dependent on B+ at the + terminal and B- on the LPA. This AC voltage is measured between any two phases and varies from 0VAC at rest to about 24VAC at full RPM.	VAC between two phases: Stationary: 0VAC Full Travel: 24VAC Stall: approx. 4VAC	LPA	Lift Motor
248	LPA (W)	Lift Motor Phase W	One of three phases from the LPA to the Lift Motor. This AC voltage is produced by the LPA and is dependent on B+ at the + terminal and B- on the LPA. This AC voltage is measured between any two phases and varies from 0VAC at rest to about 24VAC at full RPM.	VAC between two phases: Stationary: 0VAC Full Travel: 24VAC Stall: approx. 4VAC	LPA	Lift Motor
249	PC12-1	B+F (SPARE)	B+ power for optional Work Lights or RF Unit. Present when the battery is connected. It is fused through FU5 on the Fuse/Relay Card.	B+ wrt TP4 w/battery connected	Fuse/Relay Card	Work Lights and RF Unit
250	PC12-2	B-F (SPARE)	B- power for optional Work Lights or RF Unit. Present when the battery is connected. It is fused through FU6 on the Fuse/Relay Card.	<0.3V wrt TP4	Fuse/Relay Card	Work Lights and RF Unit
251	TPA (+)	TPA B+	B+ to the TPA used to produce the AC phases U, V and W when the TPC is closed to power the drive motor.	B+ w/TPC closed	B+ from TPC	TPA
252	TPA (B-)	TPA B-	B- from TP4 on the power panel. It is used for the power circuits on the TPA. Without B-, U, V and W cannot be produced and the drive motor will not turn.	<0.5V	TP4	TPA
253	TPA (U)	Traction Motor Phase U	One of three phases from the TPA to the traction motor. This AC voltage is produced by the TPA and is dependent on B+ at TPA (+) and B- at TPA (B-). This AC voltage is measured between any two phases and varies from 0VAC at rest to about 24VAC at full acceleration.	VAC between two phases: Stationary: 0VAC Full Travel: 24VAC Stall: approx. 4VAC	TPA	Drive Motor

Pin-Out Matrix

Item	Connection	Function Description	Theory of Operation	Normal Level	Signal Source	Signal User
254	TPA (V)	Traction Motor Phase V	One of three phases from the TPA to the traction motor. This AC voltage is produced by the TPA and is dependent on B+ at TPA (+) and B- at TPA (B-). This AC voltage is measured between any two phases and varies from 0VAC at rest to about 24VAC at full acceleration.	VAC between two phases: Stationary: 0VAC Full Travel: 24VAC Stall: approx. 4VAC	TPA	Drive Motor
255	TPA (W)	Traction Motor Phase W	One of three phases from the TPA to the traction motor. This AC voltage is produced by the TPA and is dependent on B+ at TPA (+) and B- at TPA (B-). This AC voltage is measured between any two phases and varies from 0VAC at rest to about 24VAC at full acceleration.	VAC between two phases: Stationary: 0VAC Full Travel: 24VAC Stall: approx. 4VAC	TPA	Drive Motor

Torque Chart - Standard (Brass)

Torque Chart - Standard (Brass)

Brass MS63 Standard Bolts, Coarse Thread		
Size	Torque (with bolts oiled*)	
	N•m	in. lb.
4-40	0.37	3.3
4-48	0.40	3.6
6-32	0.69	6.1
6-40	0.77	6.8
8-32	1.24	11
8-36	1.24	11
10-24	1.58	14
10-32	1.92	17
1/4-20	3.96	35
1/4-28	4.52	40
5/16-18	8.25	73
5/16-24	9.15	81
3/8-16	14.69	130
3/8-24	16.61	147

Note: Use "oiled" values for bolts with thread-locking compound.

Decimal Equivalent Chart

Decimal Equivalent Chart

4ths	8ths	16ths	32nds	64ths	To 3 Places	To 2 Places	MM Equivalent
				1/64	.016	.02	0.397
			1/32		.031	.03	0.794
				3/64	.047	.05	1.191
		1/16			.062	.06	1.587
				5/64	.078	.08	1.984
			3/32		.094	.09	2.381
				7/64	.109	.11	2.778
	1/8				.125	.12	3.175
				9/64	.141	.14	3.572
			5/32		.156	.16	3.969
				11/64	.172	.17	4.366
		3/16			.188	.19	4.762
				13/64	.203	.20	5.159
			7/32		.219	.22	5.556
				15/64	.234	.23	5.593
1/4					.250	.25	6.350
				17/64	.266	.27	6.747
			9/32		.281	.28	7.144
				19/64	.297	.30	7.540
		5/16			.312	.31	7.937
				21/64	.328	.33	8.334
			11/32		.344	.34	8.731
				23/64	.359	.36	9.128
	3/8				.375	.38	9.525
				25/64	.391	.39	9.922
			13/32		.406	.41	10.319
				27/64	.422	.42	10.716
		7/16			.438	.44	11.112
				29/64	.453	.45	11.509
			15/32		.469	.47	11.906
				31/64	.484	.48	12.303
1/2					.500	.50	12.700

Decimal Equivalent Chart

4ths	8ths	16ths	32nds	64ths	To 3 Places	To 2 Places	MM Equivalent
				33/64	.516	.52	13.097
			17/32		.531	.53	13.494
				35/64	.547	.55	13.891
		9/16			.562	.56	14.288
				37/64	.578	.58	14.684
			19/32		.594	.59	15.081
				39/64	.609	.61	15.478
	5/8				.625	.62	15.875
				41/64	.641	.64	16.272
			21/32		.665	.66	16.669
				43/64	.672	.67	17.065
		11/16			.688	.69	17.462
				45/64	.703	.70	17.859
			23/32		.719	.72	18.256
				47/64	.734	.73	18.653
3/4					.750	.75	19.050
				49/64	.766	.77	19.447
			25/32		.781	.78	19.844
				51/64	.797	.80	20.241
		13/16			.812	.81	20.637
				53/64	.828	.83	21.034
			27/32		.844	.84	21.431
				55/64	.859	.86	21.828
	7/8				.875	.88	22.225
				57/64	.891	.89	22.622
			29/32		.906	.91	23.019
				59/64	.922	.92	23.416
		15/16			.938	.94	23.812
				61/64	.953	.95	24.209
			31/32		.969	.97	24.606
				63/64	.984	.98	25.003
					1.000	1.00	25.400

Standard/Metric Conversions

Standard/Metric Conversions

To Convert...	Multiply, Add, or Subtract...
Area	
Square Inches to Square Centimeters	Square Inches x 6.452
Square Centimeters to Square Inches	Square Centimeters x 0.155
Square Feet to Square Meters	Square Feet x 0.093
Square Meters to Square Feet	Square Meters x 10.753
Square Yards to Square Meters	Square Yards x 0.836
Square Meters to Square Yards	Square Meters x 1.196
Distance	
Inches to Millimeters	Inches x 25.4
Millimeters to Inches	Millimeters x 0.039
Inches to Centimeters	Inches x 2.54
Centimeters to Inches	Centimeters x 0.394
Feet to Meters	Feet x 0.305
Meters to Feet	Meters x 3.281
Yards to Meters	Yards x 0.914
Meters to Yards	Meters x 1.094
Miles to Kilometers	Miles x 1.609
Kilometers to Miles	Kilometers x 0.621
Mass	
Ounces to Grams	Ounces x 28.35
Grams to Ounces	Ounces x 0.035
Ounces to Kilograms	Ounces x 0.028
Kilograms to Ounces	Kilograms x 35.27
Pounds to Kilograms	Pounds x 0.454
Kilograms to Pounds	Kilograms x 2.2
Pressure	
Pounds per Square Inch (PSI) to kiloPascals	PSI x 6.894
kiloPascals to Pounds per Square Inch (PSI)	kiloPascals x 0.145
Speed	
Miles per hour to Kilometers per hour	Miles per hour x 1.609
Kilometers per hour to Miles per hour	Kilometers per hour x 0.6214
Temperature	
Fahrenheit to Celsius	(°F minus 32) x 0.555
Celsius to Fahrenheit	(°C x 1.8) plus 32
Torque	
Inch Pounds (in. lbs.) to Newton Meters (N•m)	Inch Pounds x 0.113
Newton Meters (N•m) to Inch Pounds (in. lbs.)	Newton Meters x 8.85
Foot Pounds (ft. lbs.) to Newton Meters (N•m)	Foot Pounds x 1.3568
Newton Meters (N•m) to Foot Pounds (ft. lbs.)	Newton Meters x 0.737
Volume	
Pints to Liters	Pints x 0.473
Liters to Pints	Liters x 2.113
Quarts to Liters	Quarts x 0.946
Liters to Quarts	Liters x 1.057
Gallons to Liters	Gallons x 3.785
Liters to Gallons	Liters x 0.26

Schematics

Schematics

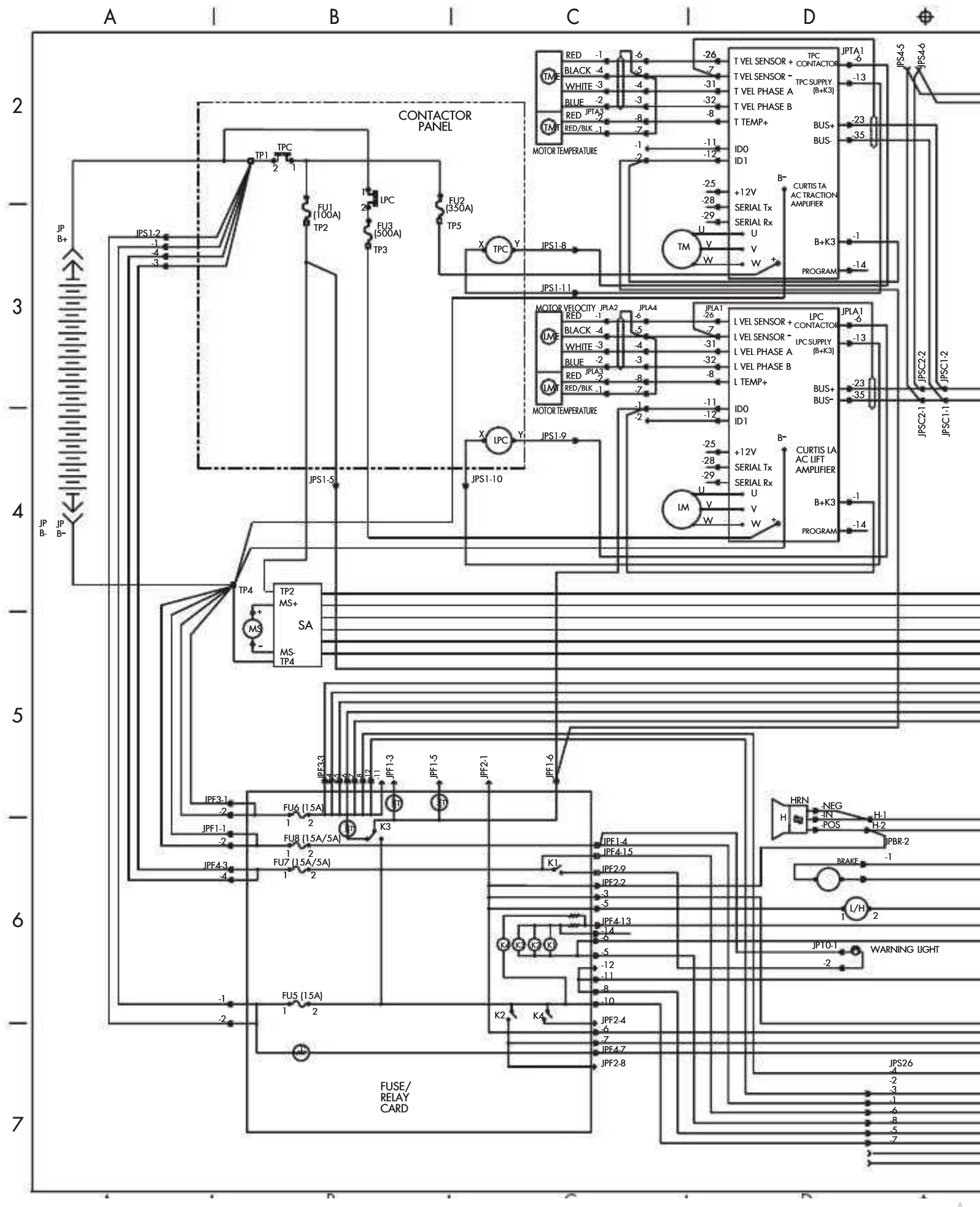
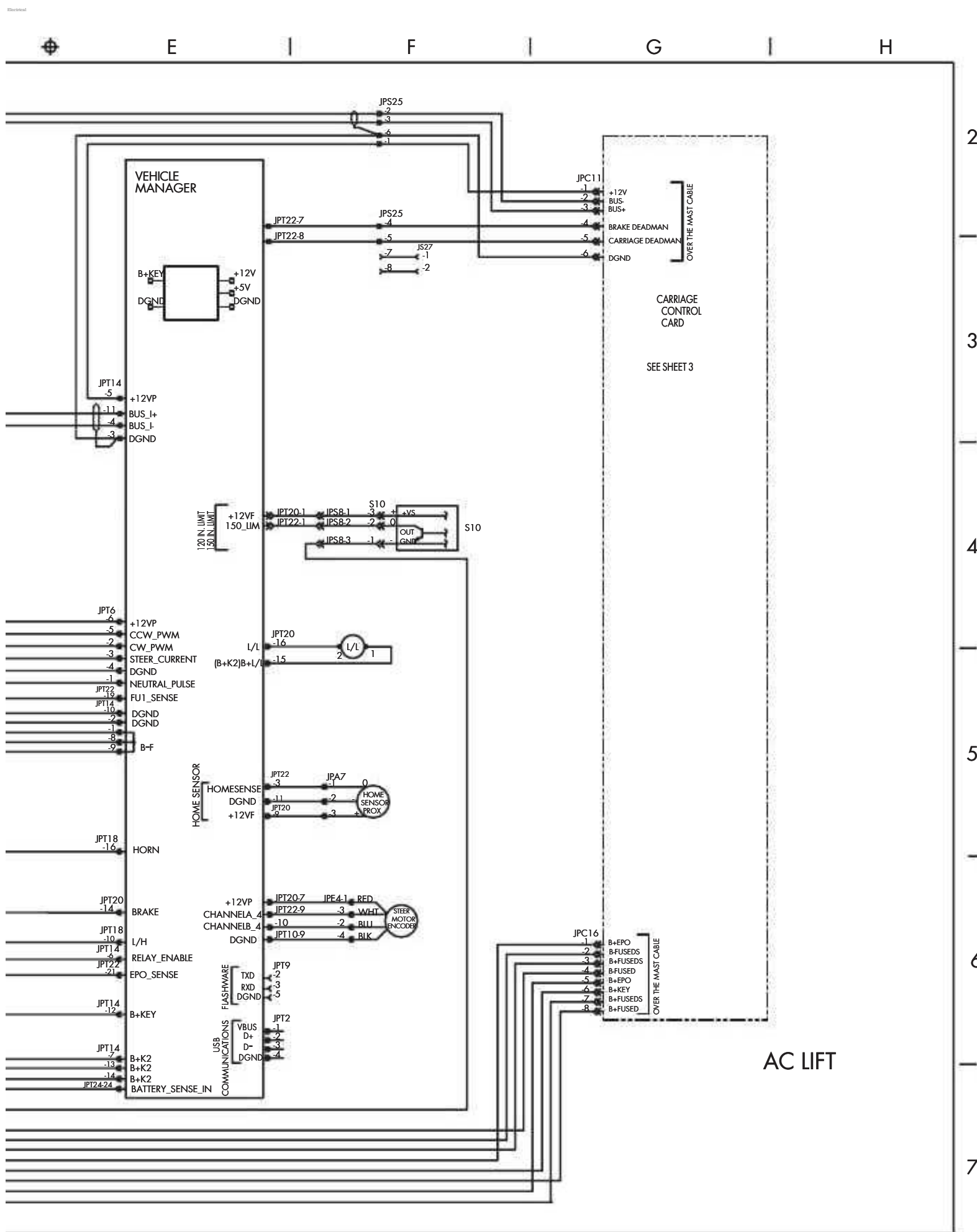

Figure A-1. Electrical Schematic Sheet 1 (AC Lift)



Schematics

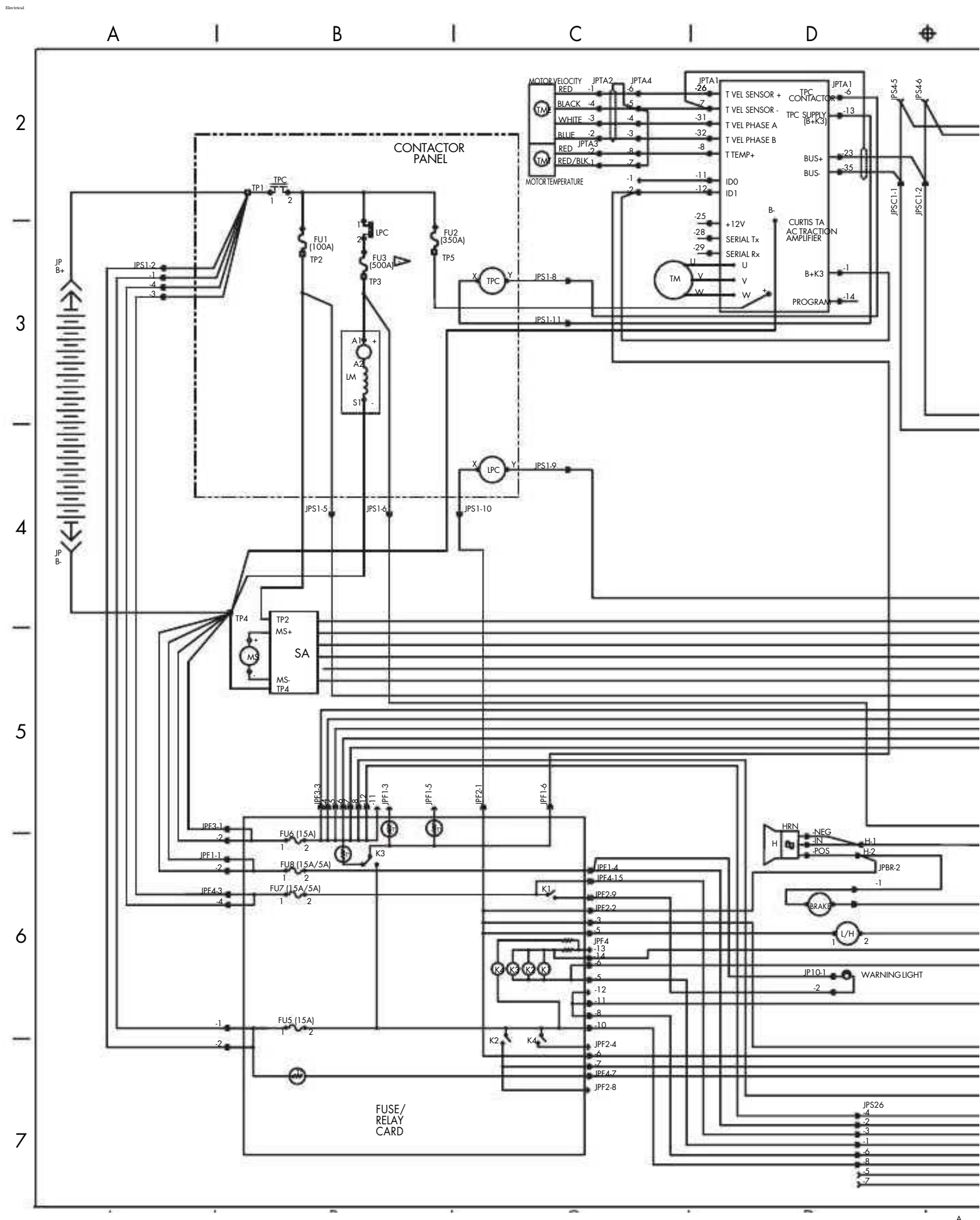
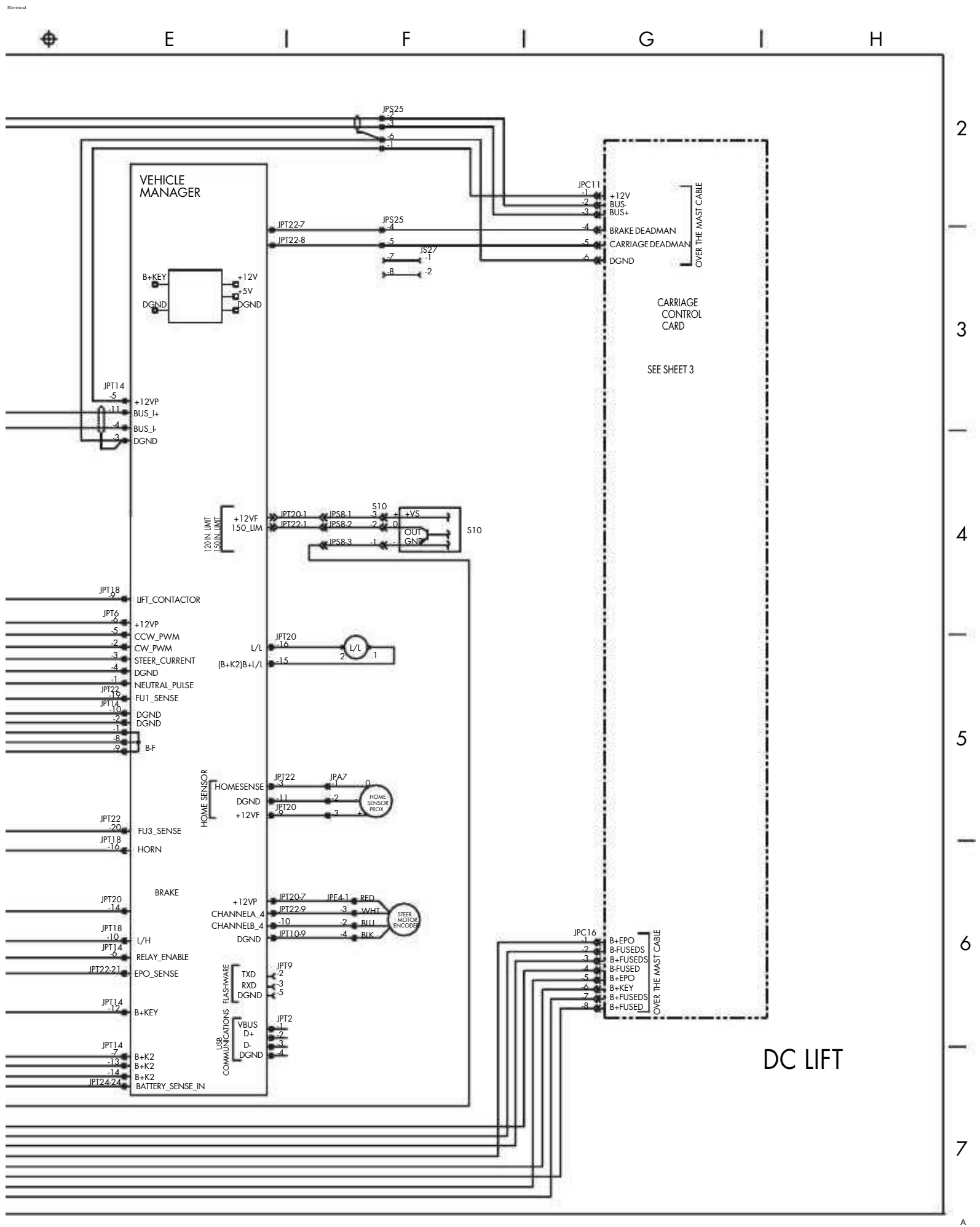

Figure A-2. Electrical Schematic Sheet 2 (DC Lift)



Schematics

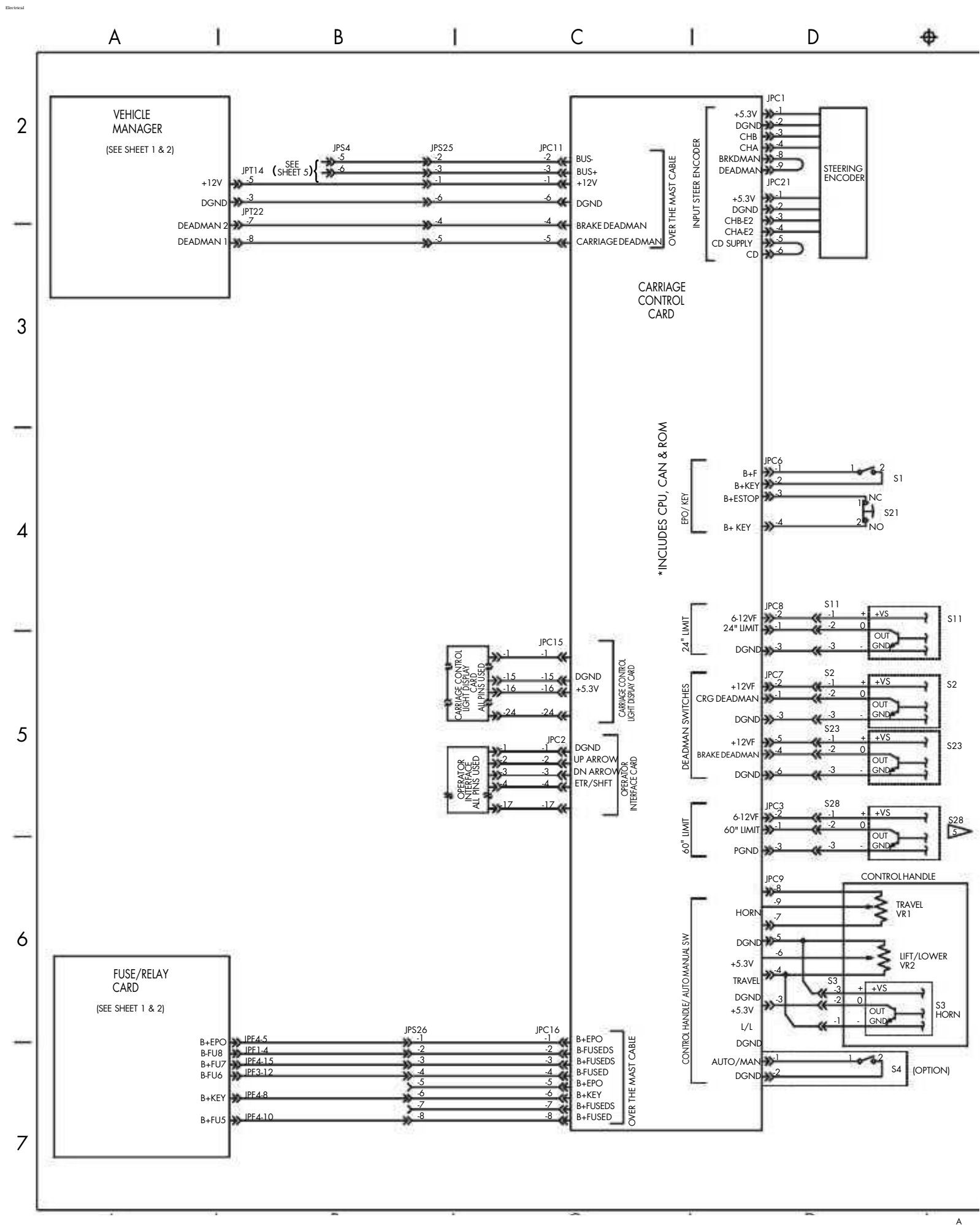

Figure A-3. Electrical Schematic Sheet 3

Removal 7-95
 Fraction to Decimal Conversion A-8
 Fuse Relay Card 8-5

G

Grounded DC Motor Test 5-9
 Guidance Manager
 Theory of Operation 8-4
 Guide Wire
 Learn Wirefreq 3-21
 Learning Wire Frequency 3-21

H

Heater Assemblies 3-36
 High Pressure Relief Valve Adjustment 7-79
 Home Proximity Sensor
 Adjustment 7-11
 Hydraulic
 Bleeding Cylinders 7-81
 Flow Sensor Service Notes 7-76
 System Storage Preparation 3-38
 Hydraulic Components
 Center Cylinder 7-88

I

Input Tests 6-55 to 6-90
 Installation 3-5
 Cold Storage Conditioning 3-6
 Warranty 3-6

K

Kit, Antistatic 2-7

L

L/L Pot Test 6-33
 Learn
 Controls 3-19
 Guide Wire Offsets 3-21
 Ht/Wt 3-19
 Mode 3-8
 When to Run 3-19
 Wirefreq 3-21
 LEDs
 Wire Guidance 6-2
 Lift

Motor 7-82
 Pump 7-82
 Lift Chain Storage Preparation 3-38
 Lift Cylinder
 Three-Stage Center w/Cushions
 Cushion Replacement 7-88
 Installation 7-89
 Seal Replacement 7-89
 Service 7-88

Lift Motor
 Terminal Nuts 7-66
 Lift Power Amplifier 7-71
 Theory of Operation 8-4
 Lift/Lower
 Knob Installation/Adjustment 7-16
 System Theory 8-10
 Valve 7-80

Lights
 Steering Indicator 6-2
 Wire Guidance LEDs 6-2
 Load Holding Valve 7-80
 Locator Photos 7-3 to 7-8
 Lubricants A-3
 Lubrication
 Specification Chart A-2
 Lubrication Equivalency Chart A-2

M

Maintenance Minder 4-3
 Disabling 4-4
 Enabling 4-3
 Maintenance Mode 3-8, 3-24
 Active 3-8, 3-24
 Static 3-8, 3-24
 Manual Design 1-3
 Map of the Manual 1-2
 Mast
 Bearing
 Shimming 7-96 to 7-101
 Inner Tele to Carriage 7-100
 Main Frame to Outer Telescopic
 7-98
 Outer Tele to Inner Tele 7-99
 Bearing Replacement
 Upper 7-97
 Checks 4-7
 Disassembly 7-98
 Messages and Codes 6-9 to 6-30
 Microprocessor Removal/Replacement 7-73
 Modes of Operation
 Program Mode 3-8

Index

Run Mode3-7

Motor

- Checks4-8
- Drive, Remove/Install7-22
- Lift7-82
- Storage Preparation3-38

Motors5-6 to 5-10, 7-64 to 7-67

AC

- Bearing Encoder7-69
- Open Winding5-10
- Service7-68
- Shorted Winding5-10
- Temperature Sensor7-68

DC

- Brush Spring Tension7-65
- Brushes7-64
- Commutator7-66
- Field Winding Test5-9
- Grounded Motor Test5-9
- Open Circuit Test5-8
- Short Circuited Armature5-9
- Tests5-8 to 5-9

Drive

- Terminal Nuts7-66

Lift

- Terminal Nuts7-66

Power Cable Nut Torques7-66

Troubleshooting

- AC5-10
- DC5-6

O

Open Circuit DC Motor Test5-8

Open Winding AC Motor5-10

Operator Display6-2

- Steering Indicator Lights6-2

Output Tests6-91 to 6-108

P

Password3-7

- How to Change3-12

Photos, Locator7-3 to 7-8

Pin Extractor3-38

Pin-Out Matrix8-19 to 8-39

Power Amplifier Replacement7-71

Power Cable Nut Torques7-66

Pressure Switch Adjustment7-83

Program Mode3-8

- Configure Mode3-8

LEARN3-8

Maintenance3-8

Pump

- Lift7-82

R

Relief Valve

- Adjustment7-79

Run Mode3-7

S

Safety

- Battery2-5
- Definitions2-2
- Electrostatic Discharge Precautions2-7
- Emergency Lower Valve2-9
- General2-3 to 2-4

Scheduled Maintenance

- 360 Day4-9
- 60 Day4-6
- Guidelines4-2 to 4-9

SealantsA-3

Sensor

- Flow7-76

Sensors

- Home Prox Adjustment7-11

Shimming Mast Bearings ...7-96 to 7-101

- Inner Tele to Carriage7-100
- Main Frame to Outer Telescopic ..7-98
- Outer Tele to Inner Tele7-99

Shorted Winding AC Motor5-10

Solenoid

- Main Load Hold
- Test6-94

Specification Plate3-4

Specifications, Vehicle3-4

Standard/Metric ConversionsA-10

Static Maintenance Mode3-8, 3-24

Steer Motor/Gearbox7-10

- Encoder Bearing Replacement ...7-10

Steering

- Indicator Lights6-2

Steering and Controls7-9

Storage

- Hydraulic Cylinders3-38
- Hydraulic System3-38
- Lift Chains3-38
- Motors3-38
- Warranty Issues3-38

SuperWord 3-7
 How to Change 3-12
 Switches
 Deadman Replacement 7-18
 Emergency Power Off 7-20
 Pressure Switch Adjustment 7-83
 Tests
 S10 6-82
 S11 6-58
 S15 6-78
 S2 6-57
 S21 6-73
 S23 6-56
 S24 6-62
 S25 6-88
 S27 6-81
 S28 6-59
 S3 6-63
 S4 6-79
 S46 6-86
 S47 6-84
 S60 & 61 6-80
 S7 6-61
 System Architecture 8-2 to 8-5
 Systems
 Theory of Operation 8-3
 Systems Overview 3-2

T

Terminal hardware 7-66
 Tests
 A04 (VR1) 6-32
 A05 (VR2) 6-33
 A08 (TM Temp) 6-34
 A09 (LM Temp) 6-35
 A10 (TPA Temp) 6-36
 A11 (TM Current) 6-37
 A13 (Press Sensor) 6-38
 A14 (VM +12V) 6-39
 A15 (Batt) 6-40
 A19 (LPA Temp) 6-41
 A20 (LM Current) 6-42
 A22 (Traction Request) 6-43
 A23 (Lift Request) 6-44
 A34 (L/L Current) 6-45
 A35 (Brake) 6-46
 A37 (Steer PA Current) 6-47
 A51 (Left Tractor Guidance Coil) . 6-49
 A52 (Right Tractor Guidance Coil) 6-50
 A53 (Left Load Guidance Coil) ... 6-51
 A54 (Right Load Guidance Coil) .. 6-52

A55 (Tractor Near Wire Coil) 6-53
 A56 (Load Near Wire Coil) 6-54
 Analog 6-31 to 6-54
 DC Motor 5-8 to 5-9
 I00 (S23) 6-56
 I01 (S2) 6-57
 I02 (S11) 6-58
 I03 (S28) 6-59
 I04 (S7) 6-61
 I05 (S24) 6-62
 I15 (S3) 6-63
 I38 (S21) 6-73
 I65 (S15) 6-78
 I66 (S4) 6-79
 I67 (S60 & 61) 6-80
 I68 (S27) 6-81
 I69 (S10) 6-82
 I72 (S47) 6-84
 I73 (S46) 6-86
 I74 (S25) 6-88
 Input 6-55 to 6-90
 O00 (TPC) 6-92
 O02 (LPC) 6-93
 O11 (SOL1) 6-94
 O12 (Ramp L/L SOL) 6-95
 O18 (Horn) 6-96
 O19 (Audible Alarm) 6-97
 O20 (Travel Alarm) 6-98
 O25 (2 Stage Select SOL) 6-99
 O28 (Ramp LM) 6-100
 O29 (Ramp TM) 6-101
 O30 (Brake SOL) 6-102
 O32 (Relays) 6-103
 O39 (OD Lights) 6-104
 O40 (L/L Alarm) 6-105
 O41 (Aux Sel SOL) 6-106
 O42 (Main Sel SOL) 6-107
 O43 (Aux Load Hold SOL) 6-108
 Output 6-91 to 6-108
 Wire Guidance 6-49 to 6-54
 Theory of Operation
 Antenna Cards 8-4
 Carriage Control Card 8-3
 Emergency Lower Valve 8-10
 Filter Card 8-4
 Fuse/Relay Card 8-5
 Guidance Manager 8-4
 Intellispeed 8-4
 Lift Power Amplifier 8-4



1031794B