

Operation & Maintenance Manual

LIFT TRUCKS

D20S-5, D25S-5, D30S-5, D33S-5, D35C-5

G20E-5, G25E-5, G30E-5

GC20E-5, GC25E-5, GC30E-5, GC33E-5

G20P-5, G25P-5, G30P-5, G33P-5, G35C-5

GC20P-5, GC25P-5, GC30P-5, GC33P-5

 **WARNING**

Do not start, operate or service this machine unless you have read and understood these instructions and received proper training.
Unsafe or improper use of the machine may cause serious injury or death.
Operators and maintenance personnel must read this manual and receive training before operating or maintaining the machine.
This manual should be kept with the machine for reference and periodically reviewed by the machine operator and by all personnel who will come into contact with it.

The following warning is provided pursuant to California Health & Safety Code Sections 25247.5 et, seq,

 **WARNING**

California Proposition 65

Engine Exhaust, some of its constituents, and certain vehicle components contain or emit chemicals known to the State of California to cause cancer and birth defects or other reproductive harm.

Battery posts, terminals and related accessories contain lead and lead compounds, chemicals known to the State of California to cause cancer and birth defects or other reproductive harm.
WASH HANDS AFTER HANDLING.

Table of Contents

Information Section

Foreword	2
----------------	---

Safety Section

Important Safety Information	4
Safety	5
Warning Signs and Labels	5
Parking brake	9
General Hazard Information	10
Operation Information	11
Maintenance Information	14
Operator Restraint System (If Equipped)	17
Avoiding Lift Truck Tipover	21
Safety Rules	23
How to Survive in a Tipover	28

General Section

Specifications	30
Noise and Vibration	42
Capacity Chart (Without Sideshifter Pneumatic) ..	43
Capacity Chart (With Sideshifter Pneumatic)	47
Capacity Chart (Without Sideshifter cushion)	51
Capacity Chart (With Sideshifter cushion)	55
Serial Number	59
Operator's Warning and Identification Plate	62

Operation Section

Operator's Station and Monitoring Systems	63
Seat Switch System (If Equipped)	67
Lift Truck Controls	69
Refueling	71
Before Starting the Engine	74
Starting the Engine	76
Dual Fuel System	79
Lift Truck Operation	82
Mono-Ped Control System (Option)	117
Auto Shift Controller ASC-100 (If Equipped)	118
Operating Techniques	121
Parking the Lift Truck	125
Lift Fork Adjustment	126
Storage Information	127
Transportation Hints	128
Towing Information	129

Maintenance Section

Inspection, Maintenance and Repair of Lift Truck Forks	130
Tire Inflation Information	134
Torque Specifications	135
Cooling System Specifications	137
Fuel Specifications	139
Lubricant Information	141
Lubricant Viscosities and Refill Capacities	143
Maintenance Intervals	144
When Required	148
Every 10 Service Hours or Daily	155
First 50 - 100 Service Hours or a Week	161
First 250 Service Hours or a Month	166
Every 250 Service Hours or Monthly	167
Every 500 Service Hours or 3 Months	176
Every 1000 Service Hours or 6 Months	185
Every 1500 Service Hours or 9 Months	191
Every 2000 Service Hours or Yearly	194
Every 2500 Service Hours or 15 Months	201
Every 3000 Service Hours or 18 Months	204

Index Section

Index	205
-------------	-----

Foreword

Literature Information

This manual should be stored in the operator's compartment in the literature holder or seat back literature storage area.

This manual contains safety, operation, transportation, lubrication and maintenance information.

Some photographs or illustrations in this publication show details or attachments that can be different from your lift truck. Guards and covers might have been removed for illustrative purposes.

Continuing improvement and advancement of product design might have caused changes to your lift truck which are not included in this publication. Read, study and keep this manual with the lift truck.

Whenever a question arises regarding your lift truck, or this publication, please consult your DOOSAN dealer for the latest available information.

Safety

The Safety Section lists basic safety precautions. In addition, this section identifies the text and locations of warning signs and labels used on the lift truck.

Read and understand the basic precautions listed in the Safety Section before operating or performing lubrication, maintenance and repair on this lift truck.

Operator Restraint System (If Equipped)

This manual contains safety, operation and maintenance information for the DOOSAN operator restraint system. Read, study and keep it handy.

WARNING

Your DOOSAN truck comes equipped with an operator restraint system. Should it become necessary to replace the seat for any reason, it should only be replaced with another DOOSAN operator restraint system.

Photographs or illustrations guide the operator through correct procedures of checking, operation and maintenance of the DOOSAN operator restraint system.

SAFE and EFFICIENT OPERATION of a lift truck depends to a great extent on the skill and alertness on the part of the operator. To develop this skill the operator should read and understand the Safe Driving Practices contained in this manual.

Forklift trucks seldom tipover, but in the rare event they do, the operator may be pinned to the ground by the lift truck or the overhead guard. This could result in serious injury or death.

Operator training and safety awareness is an effective way to prevent accidents, but accidents can still happen. The DOOSAN operator restraint system can minimize injuries. The DOOSAN operator restraint system keeps the operator substantially within the confines of the operator's compartment and the overhead guard.

This manual contains information necessary for Safe Operation. Before operating a lift truck, make sure that the necessary instructions are available and understood.

Operation

The Operation Section is a reference for the new operator and a refresher for the experienced one.

This section includes a discussion of gauges, switches, lift truck controls, attachment controls, transportation and towing information.

Photographs and illustrations guide the operator through correct procedures of checking, starting, operating and stopping the lift truck.

Operating techniques outlined in this publication are basic. Skill and techniques develop as the operator gains knowledge of the lift truck and its capabilities.

Maintenance

The Maintenance Section is a guide to equipment care. The illustrated, step-by-step instructions are grouped by servicing intervals. Items without specific intervals are listed under "When Required" topics. Items in the "Maintenance Intervals" chart are referenced to detailed instructions that follow.

Maintenance Intervals

Use the service hour meter to determine servicing intervals. Calendar intervals shown (daily, weekly, monthly, etc.) can be used instead of service hour meter intervals if they provide more convenient servicing schedules and approximate the indicated service hour meter reading. Recommended service should always be performed at the interval that occurs first.

Under extremely severe, dusty or wet operating conditions, more frequent lubrication than is specified in the "Maintenance Intervals" chart might be necessary.

Perform service on items at multiples of the original requirement. For example, at "Every 500 Service Hours or 3 Months", also service those items listed under "Every 250 Service Hours or Monthly" and "Every 10 Service Hours or Daily".

Environment Management

Note that DOOSAN INFRACORE is ISO 14001 certified which is harmonized with ISO 9001. Periodic ENVIRONMENTAL AUDITS & ENVIRONMENTAL PERFORMANCE EVALUATIONS have been made by internal and external inspection entities. LIFE-CYCLE ANALYSIS has also been made through out the total product life. ENVIRONMENT MANAGEMENT SYSTEM includes DESIGN FOR ENVIRONMENT from the initial stage of the design. ENVIRONMENT MANAGEMENT SYSTEM considers environmental laws & regulations, reduction or elimination of resource consumption as well as environmental emission or pollution from industrial activities, energy saving, environment-friendly product design(lower noise, vibration, emission, smoke, heavy metal free, ozone depleting substance free, etc.), recycling, material cost reduction, and even environmentally oriented education for the employee.

Important Safety Information

Most accidents involving product operation, maintenance and repair are caused by failure to observe basic safety rules or precautions. An accident can often be avoided by recognizing potentially hazardous situations before an accident occurs. A person must be alert to potential hazards, and use common sense. Persons must also have the necessary training, skills and tools before attempting to perform these functions.

Improper operation, lubrication, maintenance or repair of this product can be dangerous and could result in injury or death.

Do not operate or perform any lubrication, maintenance or repair on this product, until you have read and understood the operation, lubrication, maintenance and repair information.

Safety precautions and warnings are provided in this manual and on the product. If these hazard warnings are not heeded, bodily injury or death could occur to you or other persons.

The hazards are identified by the "Safety Alert Symbol" and followed by a "Signal Word" such as "WARNING" as shown below.



The meaning of this safety alert symbol is as follows:

Attention! Become Alert! Your Safety is involved.

The message that appears under the warning, explaining the hazard, can be either written or pictorially presented.

Operations that may cause product damage are identified by NOTICE labels on the product and in this publication.

DOOSAN cannot anticipate every possible circumstance that might involve a potential hazard, and common sense is always required. The warnings in this publication and on the product are therefore not all inclusive. Before any tool, procedure, work method or operating technique not specifically recommended by DOOSAN is used, you must be sure that it is safe for you and others. You should also ensure that the product will not be damaged or made unsafe by the operation, lubrication, maintenance or repair procedures you choose.

The information, specifications, and illustration in this publication are on the basis of information available at the time it was written. The specifications, torques, pressures, measurements, adjustments, illustrations, and other items can change at any time. These changes can affect the service given to the product. Obtain the complete and most current information before starting any job. DOOSAN dealers have the most current information available.

Safety

The safety rules and regulations in this section are representative of some, but not all rules and regulations noted under the Occupational Safety and Health Act (OSHA) and are paraphrased without representation that the OSHA rules and regulations have been reproduced verbatim.

Please refer to 1910.178 in Federal Register Vol. 37, No. 202, the National Fire Protection Association No. 505 (NFPA), American National Standard, ANSI B56.1 Safety Standard for Low lift and High Lift Trucks and subsequent revisions for a complete list of OSHA rules and regulations as to the safe operation of powered industrial lift trucks. Since regulations vary from country to country outside in U.S.A., operate this lift truck in accordance with local regulations.

DOOSAN lift trucks are manufactured according to the regulations and standards laid down in EU Machinery Directive 98/37/EC and EMC directive 89/336/EC. Please refer to the Directives 89/655/EC and 89/391/EC and its amendments for the safe use of DOOSAN lift trucks.

The most effective method of preventing serious injury or death to the lift truck operator or others is for the lift truck operator to be familiar with the proper operation of the lift truck, to be alert and to avoid actions or conditions which can result in an accident.

Do not operate a lift truck if in need of repair, defective or in any way unsafe. Report all defects and unsafe conditions immediately. Do not attempt any adjustments or repairs unless trained and authorized to do so.

Warning Signs and Labels

There are several specific safety signs on your lift truck. Their exact location and description of the hazard are reviewed in this section. Please take the time to familiarize yourself with these safety signs. Make sure that you can read all warning and instruction labels. Clean or replace these labels if you cannot read the words or see the pictures. When cleaning the labels use a cloth, water and soap. Do not use solvent, gasoline, etc. You must replace a label if it is damaged, missing or cannot be read. If a label is on a part that is replaced, make sure a new label is installed on the replaced part. See your dealer for new labels.

Traing Required To Operate or Service Warning



Located on the right side of the steering wheel.

WARNING

Improper operation or maintenance could result in injury or death. Do not operate or work on the lift truck unless you are properly trained. Read and understand the Operation and Maintenance Manual. Additional manuals are available from DOOSAN Lift Truck dealers.

This label also provides allowable lift truck capacity information

General Warning to Operator



Located on the right side of the operator's seat (STD).

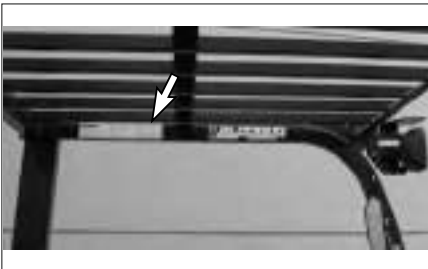

Located on the overhead guard (If Convenience Package Equipped).

WARNING

Only trained and authorized personnel may operate this machine. For safe operation, read and follow the operation and maintenance Manual furnished with this lift truck and observe the following warnings:

1. Before starting machine. Check all controls and warning devices for proper operation.
2. Refer to machine identification plate for allowable machine capacity. Do not overload. Operate machines equipped with attachments as partially loaded machines when not handling a load.
3. Put directional control or shift lever in neutral before "ON - OFF" switch is turned on.
4. Start, turn and brake smoothly. Slow down for turns, slippery or uneven surfaces. Extremely poor surfaces should be repaired. Avoid running over loose objects or holes in the roadway surfaces. Use extreme caution when turning on inclines.
5. Travel with load as low as possible and tilted back. If load interferes with visibility, travel with load trailing.
6. On grade operations travel with load up grade.
7. Watch out for pedestrians and obstructions. Check overhead clearances.
8. Do not permit riders on forks or machine at any time.
9. Do not allow anyone to stand or pass under the elevated portion of any machine.
10. Be sure operating surface can safely support machine.
11. Operate machine and attachments only from operator's position.
12. Do not handle unstable or loosely stacked loads.
13. Use minimum tilt when picking up or depositing a load.
14. Use extreme care when handling long, high, or wide loads.
15. Forks should be completely under load and spread apart as far as load permits.
16. Machine should be equipped with overhead guard or equivalent protection. Where load requires it, use a load backrest extension. Use extreme caution if operating without these devices.
17. Parking - Lower lifting mechanism to floor. Put directional control or shift lever in neutral. Set parking/secondary brake. Turn "ON - OFF" switch off. Chock wheels if machine is on incline. Disconnect battery when storing electric machines.
18. Observe safety rules when handling fuel for engine powered machine and when changing batteries for electric machines.

Pressure Warning

⚠ WARNING

Contents under pressure may be hot. Allow to cool before opening.

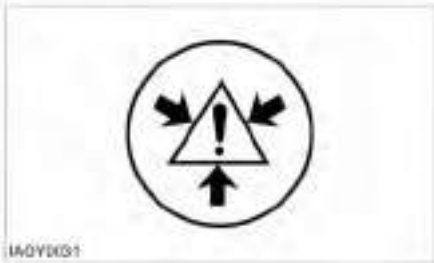

Located on the radiator top tank by the radiator cap.

Hand Placement Warning

⚠ WARNING



No hands. Do not place hands in this area. Do not touch, lean on, or reach through the mast or permit others to do so.



Located on the mast.

No Standing On Fork Warning

No Standing Under Fork Warning

⚠ WARNING

Do not stand or ride on the forks. Do not stand or ride on a load or pallet on the forks. Do not stand or walk under the forks.

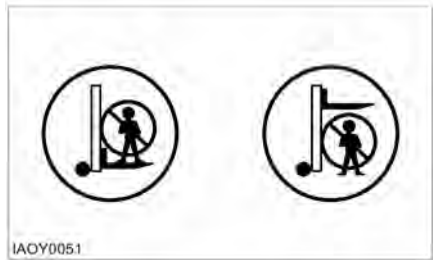

Located on the lift cylinder.

Load Backrest Must Be In Place Warning

⚠ WARNING

Operation without this device in place may be hazardous.



Located on the load backrest.

Overhead Guard Must Be In Place Warning

⚠ WARNING

Operation without this device in place may be hazardous. This guard conforms to A.N.S.I.B56.1 and F.E.M.Section IV. This design has been tested with an impact of appropriate valve.



Located on the Overhead Guard.

No Riders Warning

⚠ WARNING

To avoid personal injury, allow no riders. A lift truck is designed for only one operator and no riders.



Located beside the operator's station (STD) or on front of the hood (Convenience Package).

Moving Fan Warning

⚠ WARNING

To avoid personal injury, stay clear of moving fan.



Located inside the engine compartment cover.

Parking brake

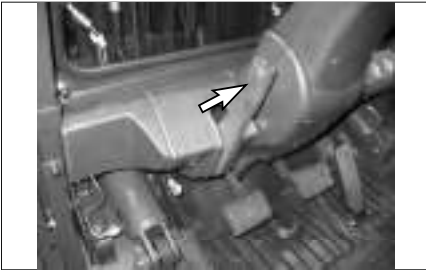

Pull the lever **BACK** to engage the parking brake.



Push the lever **FORWARD** to release the parking brake.

Applying the parking brake puts the transmission in **NEUTRAL**. The parking brake must be applied when leaving the lift truck and when starting the lift engine. If the operator leaves the seat without applying the parking brake, an audible alarm will sound.

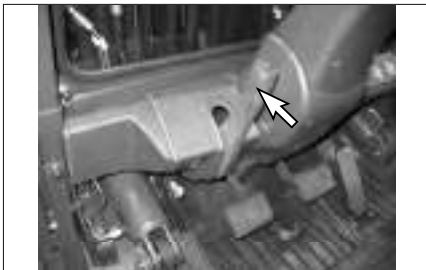

WARNING

When leaving machine apply parking brake!
 Parking brake is not automatically applied.
 Alarm will sound if parking brake is not applied.

WARNING

Correct adjustment is necessary to provide adequate braking. See the **MAINTENANCE** section for adjustment procedures. The lift truck may creep at engine idle and can cause damage, injury or death. Always apply the parking brake when leaving the lift truck. The parking brake is **NOT** automatically applied.

General Hazard Information



Attach a "Do Not Operate" or similar warning tag to start switch or controls before servicing or repairing the lift truck.

Do not start or service the lift truck when a "DO NOT OPERATE" or similar warning tag is attached to the start switch or controls.

Wear a hard hat, protective glasses and other protective equipment as required by job conditions.

Know the width of your attachments so proper clearance can be maintained when operating near fences, boundary obstacles, etc.

Do not wear loose clothing or jewelry that can catch on controls or other parts of the lift truck.

Keep the lift truck, especially the deck and steps, free of foreign material such as debris, oil tools and other items which are not part of the lift truck.

Secure all loose items such as lunch boxes, tools and other items which are not part of the lift truck.

Know the appropriate work-site hand signals and who gives them. Accept signals from one person only.

Always use the overhead guard. The overhead guard is intended to protect the lift truck operator from overhead obstructions and from falling objects.

A truck that is used for handling small objects or uneven loads must be fitted with a load backrest.

If the lift truck must be operated without the overhead guard in place due to low overhead clearance, use extreme care. Make sure there is no possibility of falling objects from any adjacent storage or work area. Make sure the load is stable and fully supported by the carriage and the load backrest extension (if equipped).

Do not raise loads any higher than necessary and never raise a load higher than 1830 mm (72 in) with the overhead guard removed.

Always use load backrest extension when the carriage or attachment does not fully support the load. The load backrest extension is intended to prevent the load or any part of the load from falling backwards into the operator's station.

When operating the lift truck, do not depend only on flashing lights or back-up alarm (if equipped) to warn pedestrians.

Always be aware of pedestrians and do not proceed until the pedestrians are aware of your presence and intended actions and have moved clear of the lift truck and/or load.

Do not drive lift truck up to anyone standing in front of an object.

Obey all traffic rules and warning signs.

Keep hands, feet and head inside the operator station. Do not hold onto the overhead guard while operating the lift truck. Do not climb on any part of the mast or overhead guard or permit others to do so.

Do not allow unauthorized personnel to ride on the forks or any other part of the lift truck, at any time.

When working in a building or dock, observe floor load limits and overhead clearances.

Inhaling Freon gas through a lit cigarette or other smoking method or inhaling fumes released from a flame contacting Freon can cause bodily harm or death. Do not smoke when servicing air conditioners or wherever Freon gas may be present.

Never put maintenance fluids into glass containers. Use all cleaning solutions with care.

Do not use steam, solvent, or high pressure to clean electrical components.

Report all needed repairs.



Inspect the part of the chain that is normally operated over the crosshead roller. When the chain bends over the roller, the movement of the parts against each other causes wears.

Inspect to be sure that chain link pins do not extend outside of the bore hole.

If any single link pin is extended beyond its connecting corresponding link, it should be suspected of being broken inside of its bore hole.

Inspect the chain anchor and the anchor links for wear.

Do not change any factory set adjustment values (including engine rpm setting) unless you have both authorization and training. Especially Safety equipment and switches may not be removed or adjusted incorrectly. Repairs, adjustments and maintenances that are not correct can make a dangerous operating condition.

For any checkup, repair, adjustments, maintenance and all other work concerning your forklift truck, please contact your DOOSAN dealer. We would like to draw your attention to the fact that any secondary damages due to improper handling, insufficient maintenance, wrong repairs or the use of other than original DOOSAN spare parts waive any liability by DOOSAN.

Operation Information

Mounting and Dismounting

Mount and dismount the lift truck carefully.

Clean your shoes and wipe your hands before mounting.

Use both hands and face the lift truck when mounting and dismounting.

Use the handgrips for mounting and dismounting.

Do not try to climb on or off the lift truck when carrying tools or supplies.

Do not use any controls as handholds when entering or leaving the operator's station.

Never get on or off a moving lift truck. Never jump off the lift truck.

Keep hands and steering wheel free of slippery material.

Before Starting the Lift Truck

Perform a walk-around inspection daily and at the start of each shift. Refer to the topic "Walk-around Inspection" in "Every 10 Service Hours or Daily" section of this manual.

Adjust the seat so that full brake pedal travel can be obtained with the operator's back against the seat back.

Make sure the lift truck is equipped with a lighting system as required by conditions.

Make sure all hydraulic controls are in the HOLD position.

Make sure the direction control lever is in the NEUTRAL position.

Make sure the parking brake is engaged.

Make sure no one is standing and/or working on, underneath or close to the lift truck before operating the lift truck.

Operate the lift truck and controls only from the operator's station.

Make sure the lift truck horn, lights, backup alarm (if equipped) and all other devices are working properly.

Check for proper operation of mast and attachments. Pay particular attention to unusual noises or erratic movement which might indicate a problem.

Make sure service and parking brakes, steering, and directional controls are operational.

Make sure all personnel are clear of lift truck and travel path.

Refer to the topic "Lift Truck Operation" in the "Operation Section" of this manual for specific starting instructions.

Starting the Lift truck



Do not start the engine or move any of the controls if there is a "DO NOT OPERATE" or similar warning tag attached to the start switch or controls.

Before Operating the Lift Truck

Test brakes, steering controls, horn and other devices for proper operation. Report any faulty performance. Do not operate lift truck until repaired.

Learn how your lift truck operates. Know its safety devices. Know how the attachments work. Before moving the lift truck, look around. Start, turn and brake smoothly.

An operator must constantly observe his lift truck for proper operation.

Operating the Lift Truck

Always keep the lift truck under control.

Obey all traffic rules and warning signs.

Never leave the lift truck with the engine operating, or with the parking brake disengaged.

Operate the engine only in a well ventilated area.

Lower a mast, with or without load, before turning or traveling. Tip over could result. Watch out for overhead obstructions.

Always observe floor load limits and overhead clearance.

Start, turn, and brake smoothly. Slow down for turns, grades, slippery or uneven surfaces.

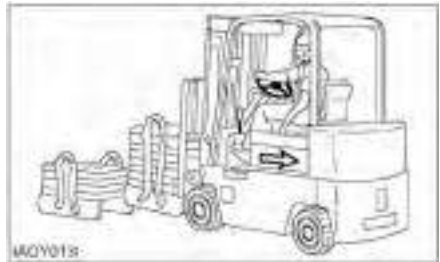

Use special care when operating on grades. Do not angle across or turn on grades. Do not use lift truck on slippery grades. Travel with forks downgrade when unloaded. Travel with load upgrade.

Do not overload, or handle offset, unstable, or loosely stacked loads. Refer to load capacity plate on the lift truck. Use extreme caution when handling suspended, long, high or wide load.



Tilt the elevated load forward only when directly over unloading area and with load as low as possible.

Do not stunt ride or indulge in horseplay.

Always look and keep a clear view of the path of travel.

Travel in reverse if load or attachment obstructs visibility. Use extreme caution if visibility is obstructed.

Stay in designated travel path, clear of dock edges, ditches, other drop-offs and surfaces which cannot safely support the lift truck.

Slow down and use extra care through doorways, intersections and other location where visibility is reduced.

Slow down for cross aisles, turns, ramps, dips, uneven or slippery surfaces and in congested areas, avoid pedestrians, other vehicles, obstruction, pot holes and other hazards or objects in the path of travel.

Always use overhead guards except where operation conditions do not permit. Do not operate lift truck in high stacking areas without overhead guards.

When stacking, watch for falling objects. Use load backrest extension and overhead guard.

Refer to the topic "Operation Techniques" in the "Operation Section" of this manual.

Loading or Unloading Trucks/Trailers

Do not operate lift trucks on trucks or trailers which are not designed or intended for that purpose. Be certain truck or trailer brakes are applied and wheel chocks in place (or be certain unit is locked to the loading dock) before entering onto trucks or trailers.

If trailer is not coupled to tractor, make sure the trailer landing gear is properly secured in place. On some trailers, extra supports may be needed to prevent upending or corner dipping.

Be certain dock plates are in good condition and properly placed and secured. Do not exceed the rated capacity of dock boards or bridge plates.

Lift Truck Parking

When leaving the operator station, park the lift truck in authorized areas only. Do not block traffic.



- Park the lift truck level, with the forks lowered and the mast tilted forward until the fork tips touch the floor.
- Move the direction control lever to NEUTRAL.
- Engage the parking brake.
- Turn the key switch off and remove the key.
- Turn the disconnect switch to OFF (if equipped).
- Block the drive wheels when parking on an incline.

Maintenance Information

Perform all maintenance unless otherwise specified as follows:

- Park the lift truck in authorized areas only.
- Park the lift truck level, with the forks lowered and the mast tilted forward until the fork tips touch the floor.
- Place the transmission controls in neutral.
- Engage the parking brake.
- Stop the engine.
- Remove the start switch key and turn the disconnect switch OFF (if equipped).
- Block the drive wheels when parking on an incline.

Pressure Air

Pressure air can cause personal injury. When using pressure air for cleaning, wear a protective face shield, protective clothing and protective shoes.

The maximum air pressure must be below 205 kPa (30 psi) for cleaning purposes.

Fluid Penetration

Always use a board or cardboard when checking for a leak. Escaping fluid under pressure, even a pinhole size leak, can penetrate body tissue, causing serious injury, and possible death. If fluid is injected into your skin, it must be treated by a doctor familiar with this type of injury immediately.

Crushing or Cutting Prevention

Support equipment and attachments properly when working beneath them. Do not depend on hydraulic cylinders to hold it up. Any attachment can fall if a control is moved, or if a hydraulic line breaks.

Never attempt adjustments while the lift truck is moving or the engine is running unless otherwise specified.

Where there are attachment linkages, the clearance in the linkage area will increase or decrease with movement of the attachment.

Stay clear of all rotating and moving parts.

Keep objects away from moving fan blades.

They will throw or cut any object or tool that falls or is pushed into them.

Do not use a kinked or frayed wire rope cable. Wear gloves when handling the wire rope cable.

Retainer pins, when struck with force, can fly out and injure nearby persons. Make sure the area is clear of people when driving retainer pins.

Wear protective glasses when striking a retainer pin to avoid injury to your eyes.

Chips or other debris can fly off objects when struck. Make sure no one can be injured by flying debris before striking any object.

Falling Objects Protective Structure (FOPS)

This is an attached guard located above the operator's compartment and secured to the lift truck.

To avoid possible weakening of the Falling Objects Protective Structure (FOPS), consult a DOOSAN dealer before altering, by adding weight to, welding on, or cutting or drilling holes into the structure.

The overhead guard is not intended to protect against every possible impact. The overhead guard may not protect against some objects penetrating into the operator's station from the sides or ends of the lift truck.

The lift truck is equipped with an overhead guard and FOPS as standard. If there is a possibility of overhead objects falling through the guard, the guard must be equipped with smaller holes or a Plexiglas cover.

Any altering done that is not specifically authorized by DOOSAN invalidates DOOSAN's FOPS certification. The protection offered by this FOPS will be impaired if it has been subjected to structural damage. Structural damage can be caused by an overturn accident, by falling objects, etc.

Do not mount any item such as fire extinguishers, first aid kits and lights by welding brackets to or drilling holes in any FOPS structure. See your DOOSAN dealer for mounting guidelines.

Burn Prevention

Coolant

At operating temperature, the engine coolant is hot and under pressure. The radiator and all lines to heaters or the engine contain hot water or steam. Any contact can cause severe burns.

Steam can cause personal injury.

Check the coolant level only after engine has been stopped and the filter cap is cool enough to remove with your bare hand.

Remove the cooling system filter cap slowly to relieve pressure.

Cooling system additive contains alkali that can cause personal injury. Avoid contact with the skin and eyes and do not drink.

Allow cooling system components to cool before draining.

Oils

Hot oil and components can cause personal injury. Do not allow hot oil or components to contact the skin.

At operation temperature, the hydraulic tank is hot and can be under pressure.

Remove the hydraulic tank filter cap only after the engine has been stopped and the filter cap is cool enough to remove with your bare hand.

Remove the hydraulic tank filter cap slowly to relieve pressure.

Relieve all pressure in air, oil fuel or cooling systems before any lines, fittings or related items are disconnected or removed.

Batteries

Batteries give off flammable fumes which can explode.

Do not smoke when observing the battery electrolyte levels.

Electrolyte is an acid and can cause personal injury if it contacts skin or eyes.

Always wear protective glasses when working with batteries.

Fire or Explosion Prevention

All fuels, most lubricants and some coolant mixtures are flammable.

Fuel leaked or spilled onto hot surfaces or electrical components can cause a fire.

Do not smoke while refueling or in a refueling area.

Do not smoke in areas where batteries are charged, or where flammable materials are stored.

Batteries in series can be located in separate compartments. When using jumper cables always connect positive(+) cable to positive(+) terminal of battery connected to starter solenoid and negative(-) cable from external source to starter negative(-) terminal.

(If not equipped with starter negative(-) terminal, connect to engine block.)

See the Operation Section of this manual for specific starting instructions.

Clean and tighten all electrical connections. Check daily for loose or frayed electrical wires. Have all loose or frayed electrical wires tightened, repaired or replaced before operating the lift truck.

Keep all fuels and lubricants stored in properly marked containers and away from all unauthorized persons.

Store all oily rags or other flammable material in a protective container, in a safe place.

Do not weld or flame cut on pipes or tubes that contain flammable fluids. Clean them thoroughly with nonflammable solvent before welding or flame cutting on them.

Remove all flammable materials such as fuel, oil and other debris before they accumulate on the lift truck.

Do not expose the lift truck to flames, burning brush, etc., if at all possible.

Shields, which protect hot exhaust components from oil or fuel spray in the event of a line, tube or seal failure, must be installed correctly.

Do not operate in areas where explosive gases exist or are suspected.

Fire Extinguisher

Have a fire extinguisher-type BC and 1.5KG minimum capacity-on rear overhead guard leg with latch and know how to use it. Inspect and have it serviced as recommended on its instruction plate.

Ether

Ether is poisonous and flammable.

Breathing ether vapors or repeated contact of ether with skin can cause personal injury.

Use ether only in well-ventilated areas.
Do not smoke while changing ether cylinders.

Use ether with care to avoid fires.

Do not store replacement ether cylinders in living areas or in the operator's compartment.

Do not store ether cylinders in direct sunlight or at temperatures above 39°C (102°F).

Discard cylinders in a safe place. Do not puncture or burn cylinders.

Keep ether cylinders out of the reach of unauthorized personnel.

Lines, Tubes and Hoses

Do not bend or strike high pressure lines. Do not install bent or damaged lines, tubes or hoses.

Repair any loose or damaged fuel and oil lines, tubes and hoses. Leaks can cause fires. Contact your DOOSAN dealer for repair or replacement.

Check lines, tubes and hoses carefully. Do not use your bare hand to check for leaks. Use a board or cardboard to check for leaks. See Fluid Penetration in the Safety Section for more details. Tighten all connections to the recommended torque. Replace if any of the following conditions are found.

- End fittings damaged or leaking.
- Outer covering chafed or cut and wire reinforcing exposed.
- Outer covering ballooning locally.
- Evidence of kinking or crushing of the flexible part of hose.
- Armoring embedded in the outer cover.
- End fittings displaced.

Make sure that all clamps, guards and heat shields are installed correctly to prevent vibration, rubbing against other parts, and excessive heat during operation.

Tire Information

Explosions of air-inflated tires have resulted from heat-induced gas combustion inside the tires. The heat, generated by welding or heating rim components, external fire, or excessive use of brakes can cause gaseous combustion.

A tire explosion is much more violent than a blowout. The explosion can propel the tire, rim and axle components as far as 500 m (1500 ft) or more from the lift truck. Both the force of the explosion and the flying debris can cause personal injury or death, and property damage.

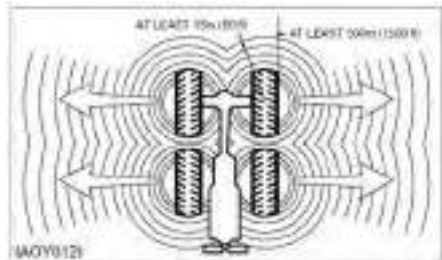

Do not approach a warm tire closer than the outside of the area represented by the shaded area in the above drawing.

Dry nitrogen (N₂) gas is recommended for inflation of tires. If the tires were originally inflated with air, nitrogen is still preferred for adjusting the pressure. Nitrogen mixes properly with air.

Nitrogen inflated tires reduce the potential of a tire explosion, because nitrogen does not support combustion. Also, nitrogen helps prevent oxidation and the resulting deterioration of rubber and corrosion of rim components.

Proper nitrogen inflation equipment and training in its use are necessary to avoid over-inflation. A tire blowout or rim failure can result from improper or misused equipment.

Stand behind the tread and use a self-attaching chuck when inflation a tire.

Servicing, changing tires and rims can be dangerous and should be done only by trained personnel using proper tools and procedures. If correct procedures are not followed while servicing tires and rims, the assemblies could burst with explosive force and cause serious personal injury or death. Follow carefully the specific information provided by your tire or rim servicing personnel or dealer.

Operator Restraint System(If Equipped)

Warning Signs and Labels

Your DOOSAN lift truck has the following tipover warning decals.

Make sure that you can read all safety signs. Clean or replace these if you cannot read the words or see the pictures. When cleaning the labels use a cloth, water and soap. Do not use solvent, gasoline, etc. You must replace a label if it is damaged, missing or cannot be read. If a label is on a part that is replaced, make sure a new label is installed on the replaced part. See your DOOSAN Lift Truck dealer for new labels.

The most effective method of preventing serious injury or death to yourself or others is to familiarize yourself with the proper operation of the lift truck, to be alert, and to avoid actions or conditions which can result in an accident.

WARNING

Tipover can occur if the truck is improperly operated. In the event of tipover, injury or death could result.





The "Survive in tipover" warning is located on the overhead guard. It shows the proper use of the operator restraint system.

Seat Adjustment



Move the lever, slide the seat to the desired position, and release the lever.

Adjust the seat before operating the lift truck. After adjusting, set the seat to make sure it is properly locked. Do not adjust the seat while the truck is in motion.

WARNING

Do not place your hand or fingers under the seat. Injury may occur as the seat moves up and down.

If Optional Suspension Seat (weight adjusting type) Equipped

Forward and Backward Adjustment

The seat can be adjusted by pushing the lever on the right side of seat.

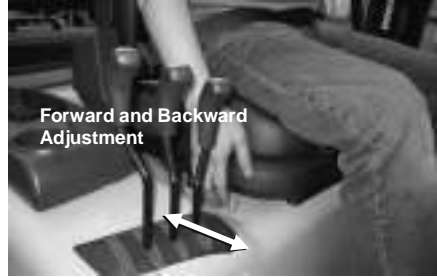

Adjust the seat before operating the lift truck. After adjusting, set the seat to make sure it is properly locked. Do not adjust the seat while the truck is in motion .

Weight adjustment

Pull the weight adjustment lever upwards and move right or left side.
Adjust to driver's weight in 7 steps (50 ~ 110 kg)

NOTICE

Do not place your hand or fingers under the seat.
Injury may occur as the seat moves up and down.



Backrest Inclination

The backrest angle can be adjusted by using the lever on the left side of seat.

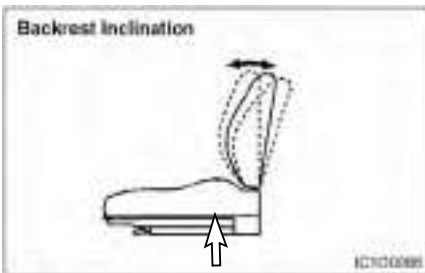

Seat Belt

The Operator Restraint System, Prevents the operator from jumping from the operator's compartment in the event of a forward or side tipover. The system is designed to keep the operator on the seat and in the operator's compartment in the event of a tipover.

Inspection

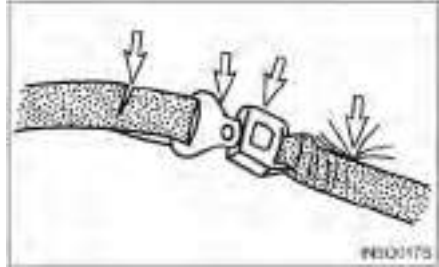

1. If the seat belt is torn, if pulling motion is interrupted during extension of the belt, or if the belt cannot be inserted into the buckle properly, replace the seat belt assembly.

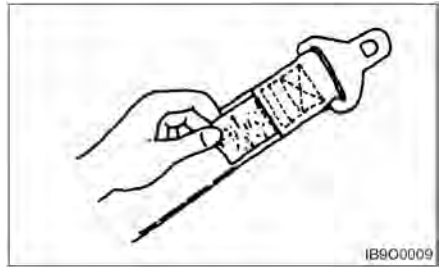

2. Belt Maintenance - Every 500 service hours. Check that the belt fastening works properly and that winding device is free from run lock when jerked. Check that the belt is suitably fastened to the seat. Check that the seat is correctly secured to the hood and the chassis. On visual inspection, fastenings must be intact, otherwise, contact the safety manager.

⚠ WARNING

Your DOOSAN truck comes equipped with a DOOSAN operator restraint system. Should it become necessary to replace the seat for any reason, it should only be replaced with another DOOSAN operator restraint system.



3. In the event of a tipover, the seat and restraint system should be inspected for damage and replaced, if necessary.

NOTE: Operator restraints shall be examined at the regular truck service intervals. It is recommended that they be replaced if any of the following conditions are found:

- Cut or frayed strap
- Worn or damaged hardware including anchor points
- Buckle or retractor malfunction
- Loose stitching

⚠ WARNING

The seat belt may cause the operator to bend at the waist. If you are pregnant or have suffered from some abdominal disease, consult a doctor before you use the seat belt.

Fasten the Seat Belt

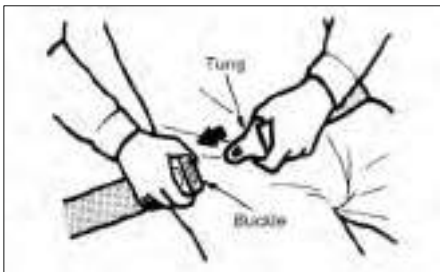

1. Grip the plate (connector) of the belt and pull the belt from the retractor. Then insert the plate into the slot of the buckle until a snap is heard. Pull on the belt to confirm it is latched.
2. Make sure the belt is not twisted.

⚠ WARNING

If you fasten the belt across your abdomen, the belt may injure your abdomen in an accident.

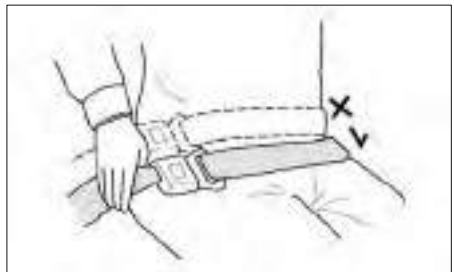

3. Be sure to fasten the belt across your hips, not across your abdomen.

NOTE: The belt is designed to automatically adjust to your size and movement. A quick pull on the belt will confirm that the automatic adjuster will hold the belt position in the event of an accident.

Release the Seat Belt

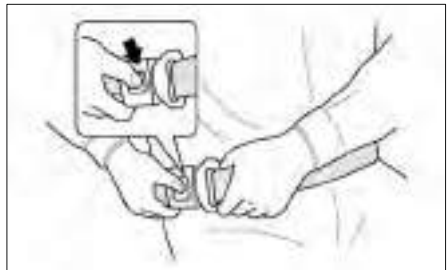

Push the button of the buckle to release the belt. The belt will automatically retract when released. Hold the plate of the belt and allow the belt to slowly retract.

Avoiding Lift Truck Tipover

Lift Truck Stability

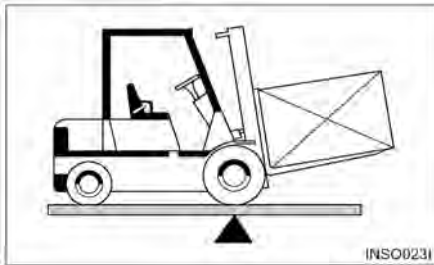

Counterbalanced lift truck design is based on the balance of two weights on opposite sides of a fulcrum (the front axle). The load on the forks must be balanced by the weight of the lift truck. The location of the center of gravity of both the truck and the load is also a factor. This basic principle is used for picking up a load. The ability of the lift truck to handle a load is discussed in terms of center of gravity and both forward and sideways stability.

Center of Gravity (CG)

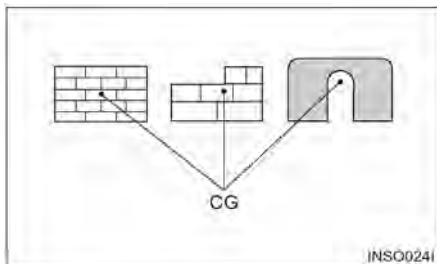

The point within an object, at which the whole weight of the object may be regarded as being concentrated, is called the center of gravity or CG. If the object is uniform, its geometric center will coincide with its CG. If it is not uniform, the CG could be at a point outside of the object. When the lift truck picks up a load, the truck and load have a new combined CG.

Stability and Center of Gravity

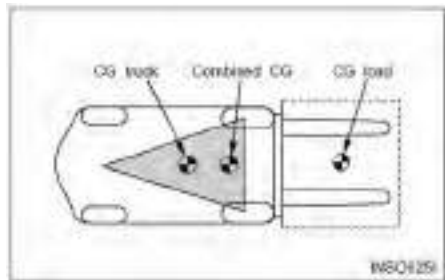

The stability of the lift truck is determined by the location of its CG; or, if the truck is loaded, the combined CG of the truck and load. The lift truck has moving parts and, therefore, has a CG that moves. The CG moves forward or backward as the mast is tilted forward or backward. The CG moves up or down as the mast moves up or down. The CG and, therefore, the stability of the loaded lift truck, are affected by a number of factors such as:

- the size, weight, shape and position of the load
- the height to which the load is lifted
- the amount of forward or backward tilt
- tire pressure
- dynamic forces created when the lift truck is accelerated, braked or turned
- condition and grade of surfaces on which the lift truck is operated

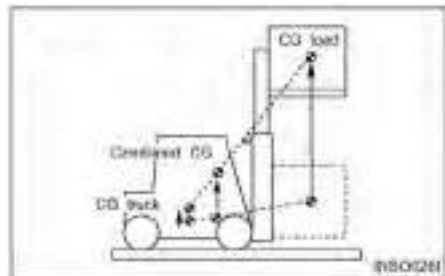

These same factors are also important for unloaded lift trucks. They tip over sideways easier than a loaded lift truck carrying its load in the lowered position.

Lift Truck Stability Base

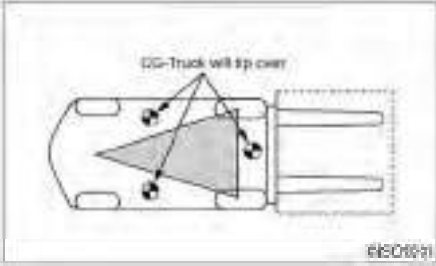

For the lift truck to be stable (not tip over forward or to the side), the CG must stay within the area of the lift truck stability base – a triangular area between the front wheels and the pivot of the steer wheels. If the CG moves forward of the front axle, the lift truck will tip forward. If the CG moves outside of the line on either side of the stability base, the lift truck will tip to the side.

⚠ WARNING

Dynamic forces (braking, acceleration, turning) also affect stability and can produce tipover even when the CG is within the stability triangle.

Capacity Load (Weight and Load Center)

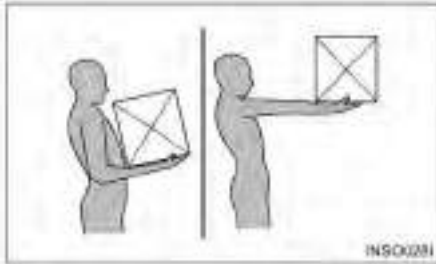

The capacity load of the lift truck is shown on the capacity/nameplate riveted to the truck. It is determined by the weight and load center. The load center is determined by the location of the CG of the load.

The load center shown on the nameplate is the horizontal distance from the front face of the forks, or the load face of an attachment, to the CG of the load. The location of the CG in the vertical direction is the same as the horizontal dimension.

Remember that, unless otherwise indicated, the capacity load shown on the nameplate is for a standard lift truck with standard backrest, forks and mast, and having no special-purpose attachment. In addition, the capacity load assumes that the load center is no further from the top of the forks than it is from the face of the backrest. If these conditions do not exist, the operator may have to reduce the safe operating load because the truck stability may be reduced. The lift truck should not be operated if its capacity/nameplate does not indicate capacity load.

NOTE: If the load is not uniform, the heaviest portion should be placed closer to the backrest and centered on the forks.

NOTICE

1. Capacity/Nameplates originally attached to forklifts sold by DOOSAN shall not be removed, altered or replaced without DOOSAN's approval.
 2. DOOSAN assumes no responsibility for lift trucks placed in service without a valid DOOSAN Nameplate.
 3. If necessary to change your specification, contact your DOOSAN lift truck dealer.
-

Safety Rules



Only properly trained and authorized personnel should operate forklift trucks. Wear a hard hat and safety shoes when operating a lift truck. Do not wear loose clothing.



Inspect and check the condition of your forklift truck using the operator's check list before starting work. Immediately report to your supervisor any obvious defects or required repairs.



Do not operate your truck in unauthorized areas. Know your forklift truck and think safety. Do not compromise safety. Follow all safety rules and read all warning signs.



Do not operate a lift truck unless you are in the operator's seat. Keep hands and feet inside the operator's compartment. Do not put any part of the body outside of the operator's compartment. Never put any part of body into the mast structure or between the mast and the truck



Do not start, stop, turn or change direction suddenly or at high speed. Sudden movement can cause the lift truck to tip over. Slow the speed of your truck and use the horn near corners, exits, entrances, and near people.



Never operate a lift truck with wet hands or shoes. Never hold any controls with grease on your hands. Your hands or feet will slide off of the controls and cause an accident.



Do not raise anyone on the forks of your lift truck. Do not let other people ride on the truck. Lift trucks are designed to carry loads, not people.



Do not overload. Always handle loads within the rated capacity shown on the capacity plate. Do not add extra counterweight to the truck. An overload can cause the truck to roll over and cause injury to personnel and damage to the lift truck.



Do not operate your truck without the load backrest extension and overhead guard. Keep the load against the backrest with the mast tilted backward



Do not drive on soft ground. Observe all signs, especially those on maximum permitted floor loadings, elevator capacities and clearance heights. Handle loads carefully and check them closely for stability and balance.



Do not lift or move loads that are not safe. Do not pick up an off center load. Such a load increases the possibility of a tipover to the side. Make sure loads are correctly stacked and positioned across both forks. Always use the proper size pallet. Position the forks as wide as possible under the load. Position loads evenly on the forks for proper balance. Do not lift a load with one fork.



Do not drive on slippery surfaces. Sand, gravel, ice or mud can cause a tipover. If unavoidable, slow down.

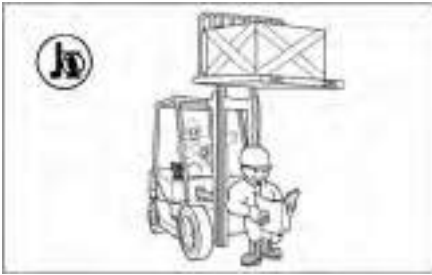

Do not permit anyone to stand or walk under the load or lifting mechanism. The load can fall and cause injury or death to anyone standing below.



Do not elevate the load with the mast tilted forward. Do not tilt the elevated loads forwards. This will cause the lift truck to tip over forward.



Look out for overhead obstructions when raising or stacking loads. Do not travel with a raised load. The lift truck can roll over and cause injury or death to you or other personnel.



Do not jump off if your truck starts to tip over. Stay in your seat to survive.

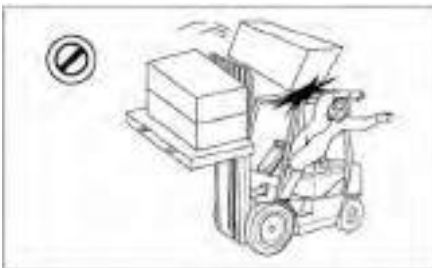

Do not move loose loads that are higher than the load backrest. Be alert for falling loads when stacking. Travel with the load tilted back and the forks as low as possible. This will increase stability to the truck and load and permit better visibility for you.



Go up ramps in forward direction and down ramps in reverse direction when moving loads. Never elevate a load with the forklift truck on an incline. Go straight off and straight down. Use an assistant when going up or down a ramp with a bulky load.

Safety Section



Do not stack or turn on ramps.
Do not attempt to pick-up or deposit a load unless the lift truck is level. Do not turn on or drive across an incline.



Do not drive in forward direction when loads restrict your visibility. Operate your lift truck in reverse to improve visibility except when moving up a ramp.



Do not go over rough terrain. If unavoidable, slow down.
Cross railroad tracks slowly and diagonally whenever possible. A railroad crossing can give a loaded forklift truck a real jolt. For smoother crossing, cross the railroad diagonally so one wheel crosses at a time.

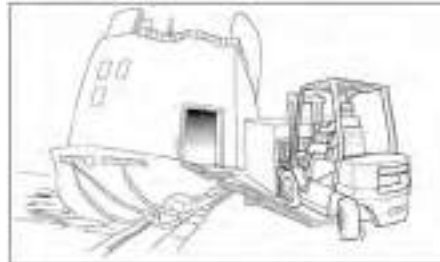

Be careful when operating a lift truck near the edge of a loading dock or ramp. Maintain a safe distance from the edge of docks, ramps and platforms. Always watch tail swing. The truck can fall over the edge and cause injury or death.



Avoid running over loose objects.
Look in the direction of travel. Look out for other persons or obstructions in your path of travel.
An operator must be in full control of his lift truck at all times.



Do not operate on bridge plates unless they can support the weight of the truck and load.
Make sure that they are correctly positioned.
Put blocks on the vehicle you enter to keep it from moving.

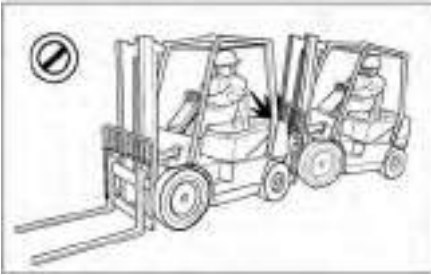

Do not operate your truck close to another truck. Always keep a safe distance from other trucks and make sure there is enough distance to stop safely. Never overtake other vehicles.



Park your lift truck in authorized areas only. Fully lower the forks to the floor, put direction lever in NEUTRAL position, engage the parking brake, and turn the key to the OFF position. Remove the key and put blocks behind the wheels to prevent the truck from rolling. Shut off your forklift truck when leaving it unattended. Check the condition of your forklift truck after the day's work.



Do not use your lift truck to push or tow another truck. Do not let another push or tow your truck. If a truck will not move, call a service technician.



Exhaust from all internal combustion engines contains carbon monoxide, a colorless, odorless, tasteless, poisonous gas. Exposure to carbon monoxide can cause serious injury or health problems, including death and avoid unnecessary idling of the engine. If nausea, dizziness or headaches are experienced stop the truck and seek fresh air.



Forklift trucks may only be refueled at specially reserved locations. Switch off the engine when refueling. Smoking and handling of naked flames during refueling are strictly prohibited. This prohibition also applies during the changing of the LPG (liquefied propane gas) tank. Mop up spilled fuel and do not forget to close the fuel tank before restarting the engine.

How to Survive in a Tipover

⚠ WARNING

In the event of a tipover, the risk of serious injury or death will be reduced if the operator is using the operator restraint system and follows the instructions provided.

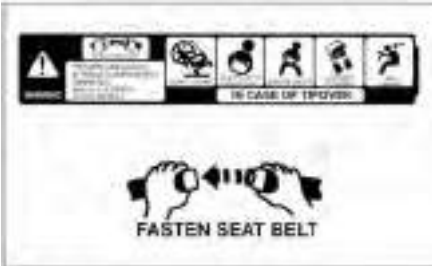

Always use operator restraint system.



Don't jump.



Hold on tight.



Brace your feet and keep them within the operator's compartment.



Lean away from the direction of fall.



Lean forward.

Specifications

CHARACTERISTICS					
1	MANUFACTURER			DOOSAN	DOOSAN
2	MODEL			D20S-5 (YANMAR,TIER2)	D25S-5 (YANMAR,TIER2)
3	CAPACITY	at rated load center	kg	2000	2500
4	LOAD CENTER	distance	mm	500	500
5	POWER TYPE	electric, diesel, gas, LPG-gas		diesel	diesel
6	OPERATOR TYPE	stand-on, ride-seated		rider-seated	rider-seated
7	TIRES	C=cushion, P=pneumatic		p	p
8	WHEELS(x=driven)	number of front/rear		2/2	2/2
DIMENSIONS					
9	LIFT WITH STD TWO-STAGE MAST	maximum fork height with rated load	mm	3230	3230
10		free lift	mm	152	152
11	FORK CARRIAGE	ISO class		II	II
12	FORKS	thickness x width x length	mm	40x100x1050	40x100x1050
13		fork spacing (maximum x minimum)	mm	275x1035	275x1035
14	TILT OF MAST	forward/backward	deg	6/10	6/10
15		length to fork face	mm	2530	2595
16		width	mm	1170	1170
17	OVERALL DIMENSIONS	mast lowered height	mm	2175	2175
18		mast extended height	mm	4490	4490
19		overhead guard height	mm	2183	2183
20		seat height	mm	1026	1026
21	OUTSIDE TURNING RADIUS		mm	2220	2265
22	LOAD MOMENT CONSTANT		mm	480	480
23	90. STACKING AISLE		mm	2700	2745
23 a	90. INTERSECTING AISLE		mm	1970	2000
PERFORMANCE					
24	SPEED	travel, loaded/unloaded	km/hr	21/21.5	21/21.5
25		lift, loaded/unloaded	mm/s	530/550	520/550
26		lowering, loaded/unloaded	mm/s	510/460	510/460
27	DRAWBAR PULL	at 1.6km/hr, loaded/unloaded	kg	1765	1740
28	GRADEABILITY	at 1.6km/hr, loaded/unloaded	%	33	28
29	ACCELERATION	time reached at max speed, loaded/unloaded	sec		
WEIGHT					
30	TOTAL WEIGHT at unloaded		kg	3580	3950
31	AXLE LOAD	at loaded, front/rear	kg	4930/650	5660/790
32		at unloaded, front/rear	kg	1720/1860	1650/2300
CHASSIS					
33	TIRES	number of front/rear		2/2	2/2
34		front size		7.00x15-12	7.00x15-12
35		rear size		6.50x10-10	6.50x10-10
36	WHEEL BASE		mm	1625	1625
37	TREAD	front/rear	mm	975/1000	975/1000
38	GROUND CLEARANCE	at loaded, the lowest point	mm	115	115
39		at loaded, center of wheelbase	mm	143	143
40	SEVICE BRAKE			foot/hyd	foot/hyd
41	PARKING BRAKE			hand/mech	hand/mech
DRIVE					
42	BATTERY	voltage/capacity	V/AH	12/85	12/85
43	ENGINE	manufacturer/model		YANMAR/4TNV98	YANMAR/4TNV98
44		rated output / rpm	kw(hp)	46.3(62.1)/2200	46.3(62.1)/2200
45		max. torque / rpm	N-m(lb-ft)	240(177)/1320	240(177)/1320
46		cycle/cylinders/displacement	cc	4/4/3319	4/4/3319
47	TRANSMISSION	type		powershift	powershift
48		number of speeds forward/reverse		1/1	1/1
49	OPERATING PRESSURE	system/attachment	bar	181/156	195/156
50	NOISE LEVEL	equivalent continuous sound pressure level (Leq) at operator's ear (DI : BITA/CE pRen 12053)	dB(A)		

DOOSAN	DOOSAN	DOOSAN	
D30S-5	D33S-5	D35C-5	1
(YANMAR,TIER2)	(YANMAR,TIER2)	(YANMAR,TIER2)	2
3000	3250	3500	3
500	500	500	4
diesel	diesel	diesel	5
rider-seated	rider-seated	rider-seated	6
p	p	p	7
2/2	2/2	2/2	8
3230	3230	3000	9
152	152	152	10
III	III	III	11
45x125x1050	45x125x1050	45x125x1050	12
286x1044	286x1044	286x1044	13
6/10	6/10	6/10	14
2700	2730	2765	15
1197	1197	1255	16
2165	2165	2165	17
4490	4490	4260	18
2183	2183	2183	19
1026	1026	1026	20
2365	2395	2420	21
485	485	495	22
2850	2880	2915	23
2050	2100	2170	23a
20/20.5	20/20.5	20.5/21	24
500/550	490/550	480/550	25
510/460	510/460	510/460	26
1830	1820	1750	27
25	23.5	21.5	28
			29
4450	4630	4810	30
6580/870	6940/940	7340/970	31
1840/2610	1800/2830	1780/3030	32
2/2	2/2	2/2	33
28x9x15-12	28x9x15-12	250x15-18	34
6.50x10-10	6.50x10-12	6.50x10-12	35
1700	1700	1700	36
982/1000	982/1000	1026/1000	37
105	105	105	38
143	143	143	39
foot/hyd	foot/hyd	foot/hyd	40
hand/mech	hand/mech	hand/mech	41
12/85	12/85	12/85	42
YANMAR/4TNV98	YANMAR/4TNV98	YANMAR/4TNV98	43
46.3(62.1)/2200	46.3(62.1)/2200	46.3(62.1)/2200	44
240(177)/1320	240(177)/1320	240(177)/1320	45
4/4/3319	4/4/3319	4/4/3319	46
powershift	powershift	powershift	47
1/1	1/1	1/1	48
216/156	216/156	216/156	49
			50

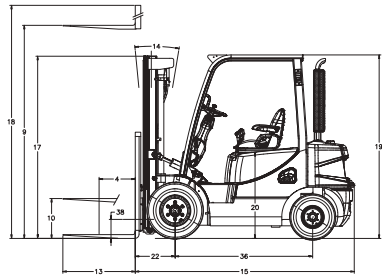
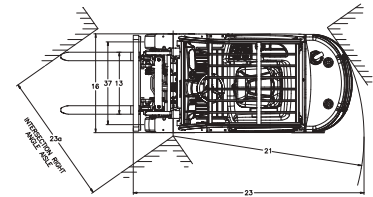

Specifications

CHARACTERISTICS					
1	MANUFACTURER				DOOSAN
2	MODEL				DOOSAN
3	CAPACITY	at rated load center	kg	2000	2500
4	LOAD CENTER	distance	mm	500	500
5	POWER TYPE	electric, diesel, gas, LPG-gas		diesel	diesel
6	OPERATOR TYPE	stand-on, ride-seated		rider-seated	rider-seated
7	TIRES	C=cushion, P=pneumatic		p	p
8	WHEELS(x=driven)	number of front/rear		2/2	2/2
DIMENSIONS					
9	LIFT WITH STD TWO-STAGE MAST	maximum fork height with rated load	mm	3230	3230
10		free lift	mm	152	152
11	FORK CARRIAGE	ISO class		II	II
12	FORKS	thickness x width x length	mm	40x100x1050	40x100x1050
13		fork spacing (maximum x minimum)	mm	275x1035	275x1035
14	TILT OF MAST	forward/backward	deg	6/10	6/10
15		length to fork face	mm	2530	2595
16		width	mm	1170	1170
17	OVERALL DIMENSIONS	mast lowered height	mm	2175	2175
18		mast extended height	mm	4490	4490
19		overhead guard height	mm	2183	2183
20		seat height	mm	1026	1026
21	OUTSIDE TURNING RADIUS		mm	2220	2265
22	LOAD MOMENT CONSTANT		mm	480	480
23	90. STACKING AISLE		mm	2700	2745
23 a	90. INTERSECTING AISLE		mm	1970	2000
PERFORMANCE					
24	SPEED	travel, loaded/unloaded	km/hr	19/19.5	19/19.5
25		lift, loaded/unloaded	mm/s	530/550	520/550
26		lowering, loaded/unloaded	mm/s	510/460	510/460
27	DRAWBAR PULL	at 1.6km/hr, loaded/unloaded	kg	1765	1740
28	GRADEABILITY	at 1.6km/hr, loaded/unloaded	%	33	28
29	ACCELERATION	time reached at max speed, loaded/unloaded	sec		
WEIGHT					
30	TOTAL WEIGHT at unloaded		kg	3580	3950
31	AXLE LOAD	at loaded, front/rear	kg	4930/650	5660/790
32		at unloaded, front/rear	kg	1720/1860	1650/2300
CHASSIS					
33	TIRES	number of front/rear		2/2	2/2
34		front size		7.00x15-12	7.00x15-12
35		rear size		6.50x10-10	6.50x10-10
36	WHEEL BASE		mm	1625	1625
37	TREAD	front/rear	mm	975/1000	975/1000
38	GROUND CLEARANCE	at loaded, the lowest point	mm	115	115
39		at loaded, center of wheelbase	mm	143	143
40	SEVICE BRAKE			foot/hyd	foot/hyd
41	PARKING BRAKE			hand/mech	hand/mech
DRIVE					
42	BATTERY	voltage/capacity	V/AH	12/85	12/85
43	ENGINE	manufacturer/model		YANMAR/4TNE98	YANMAR/4TNE98
44		rated output / rpm	kw(hp)	43.7(58.6)/2300	43.7(58.6)/2300
45		max. torque / rpm	N-m(lb-ft)	181(133)/1600	181(133)/1600
46		cycle/cylinders/displacement	cc	4/4/3319	4/4/3319
47	TRANSMISSION	type		powershift	powershift
48		number of speeds forward/reverse		1/1	1/1
49	OPERATING PRESSURE	system/attachment	bar	181/156	195/156
50	NOISE LEVEL	equivalent continuous sound pressure level (Leq) at operator's ear (DI : B/ITA/CE prEN 12053)	dB(A)		

DOOSAN	DOOSAN	DOOSAN	1
D30S-5	D33S-5	D35C-5	2
(YANMAR,TIER3)	(YANMAR,TIER3)	(YANMAR,TIER3)	
3000	3250	3500	3
500	500	500	4
diesel	diesel	diesel	5
rider-seated	rider-seated	rider-seated	6
p	p	p	7
2/2	2/2	2/2	8
3230	3230	3000	9
152	152	152	10
III	III	III	11
45x125x1050	45x125x1050	45x125x1050	12
286x1044	286x1044	286x1044	13
6/10	6/10	6/10	14
2700	2730	2765	15
1197	1197	1255	16
2165	2165	2165	17
4490	4490	4260	18
2183	2183	2183	19
1026	1026	1026	20
2365	2395	2420	21
485	485	495	22
2850	2880	2915	23
2050	2100	2170	23a
18/18.5	18/18.5	18.5/19	24
500/550	490/550	420/550	25
510/460	510/460	510/460	26
1830	1820	1750	27
25	23.5	21.5	28
			29
4450	4630	4810	30
6580/870	6940/940	7340/970	31
1840/2610	1800/2830	1780/3030	32
2/2	2/2	2/2	33
28x9x15-12	28x9x15-12	250x15-18	34
6.50x10-10	6.50x10-12	6.50x10-12	35
1700	1700	1700	36
982/1000	982/1000	1026/1000	37
105	105	105	38
143	143	143	39
foot/hyd	foot/hyd	foot/hyd	40
hand/mech	hand/mech	hand/mech	41
12/85	12/85	12/85	42
YANMAR/4TNE98	YANMAR/4TNE98	YANMAR/4TNE98	43
43.7(58.6)/2300	43.7(58.6)/2300	43.7(58.6)/2300	44
181(133)/1600	181(133)/1600	181(133)/1600	45
4/4/3319	4/4/3319	4/4/3319	46
powershift	powershift	powershift	47
1/1	1/1	1/1	48
216/156	216/156	216/156	49
			50

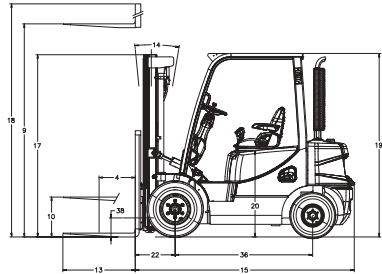
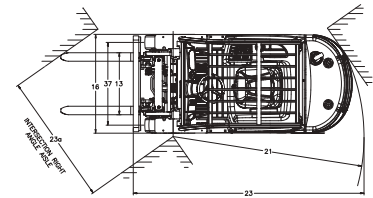

Specifications

CHARACTERISTICS			
1	MANUFACTURER		
2	MODEL		
3	CAPACITY	at rated load center	kg
4	LOAD CENTER	distance	mm
5	POWER TYPE	electric, diesel, gas, LPG-gas	
6	OPERATOR TYPE	stand-on, ride-seated	
7	TIRES	C=cushion, P=pneumatic	
8	WHEELS(x=driven)	number of front/rear	
DIMENSIONS			
9	LIFT WITH STD TWO-STAGE MAST	maximum fork height with rated load	mm
10		free lift	mm
11	FORK CARRIAGE	ISO class	
12	FORKS	thickness x width x length	mm
13		fork spacing (maximum x minimum)	mm
14	TILT OF MAST	forward/backward	deg
15	OVERALL DIMENSIONS	length without forks	mm
16		width	mm
17		mast lowered height	mm
18		mast extended height	mm
19		overhead guard height	mm
20		seat height	mm
21	OUTSIDE TURNING RADIUS		mm
22	LOAD MOMENT CONSTANT		mm
23	90° STACKING AISLE		mm
23a	90° INTERSECTING AISLE		mm
PERFORMANCE			
24	SPEED	travel, loaded/unloaded	km/hr
25		lift, loaded/unloaded	mm/s
26		lowering, loaded/unloaded	mm/s
27	DRAWBAR PULL	at 1.6km/hr, loaded/unloaded	kg
28	GRADEABILITY	at 1.6km/hr, loaded/unloaded	%
29	ACCELERATION	time reached at max speed, loaded/unloaded	sec
WEIGHT			
30	TOTAL WEIGHT at unloaded		kg
31	AXLE LOAD	at loaded, front/rear	kg
32		at unloaded, front/rear	kg
CHASSIS			
33	TIRES	number of front/rear	
34		front size	
35		rear size	
36	WHEEL BASE		mm
37	TREAD	front/rear	mm
38	GROUND CLEARANCE	at loaded, the lowest point	mm
39		at loaded, center of wheelbase	mm
40	SEVICE BRAKE		
41	PARKING BRAKE		
DRIVE			
42	BATTERY	voltage/capacity	V/AH
43	ENGINE	manufacturer/model	
44		rated output / rpm	kw(hp)
45		max. torque / rpm	N•m(lb•ft)
46		cycle/cylinders/displacement	cc
47	TRANSMISSION	type	
48		number of speeds forward/reverse	
49	OPERATING PRESSURE	system/attachment	bar
50	NOISE LEVEL	equivalent continuous sound pressure level (Leq) at operator's ear (DI : BITA/CE prEN 12053)	dB(A)

DOOSAN	DOOSAN	DOOSAN		1
G20E-5	G25E-5	G30E-5		2
2000	2500	3000		3
500	500	500		4
LP	LP	LP		5
rider-seated	rider-seated	rider-seated		6
p	p	p		7
2/2	2/2	2/2		8
3230	3230	3230		9
152	152	152		10
II	II	III		11
40x100x1050	40x100x1050	45x125x1050		12
275x1035	275x1035	286x1044		13
6/10	6/10	6/10		14
2530	2595	2700		15
1170	1170	1197		16
2175	2175	2165		17
4490	4490	4490		18
2183	2183	2183		19
1026	1026	1026		20
2220	2265	2365		21
480	480	485		22
2700	2745	2850		23
1970	2000	2050		23a
19/20	19/20	18/19		24
530/600	510/600	500/600		25
510/460	510/460	510/460		26
1440	1415	1485		27
27	22.5	20.5		28
				29
3570	3940	4380		30
4940/630	5670/770	6310/1050		31
1730/1840	1660/2280	1800/2580		32
2/2	2/2	2/2		33
7.00x15-12	7.00x15-12	28x9x15-12		34
6.50x10-10	6.50x10-10	6.50x10-10		35
1625	1625	1700		36
975/1000	975/1000	982/1000		37
115	115	105		38
143	143	143		39
foot/hyd	foot/hyd	foot/hyd		40
hand/mech	hand/mech	hand/mech		41
12/45	12/45	12/45		42
G420F(E)	G420F(E)	G420F(E)		43
39.9(53.5)/2500	39.9(53.5)/2500	39.9(53.5)/2500		44
157(116)/1600	157(116)/1600	157(116)/1600		45
4/4/1975	4/4/1975	4/4/1975		46
powershift	powershift	powershift		47
1/1	1/1	1/1		48
181/156	195/156	216/156		49
				50

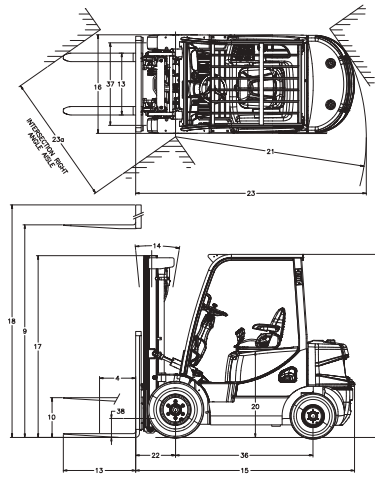

Specifications

CHARACTERISTICS						
1	MANUFACTURER			DOOSAN	DOOSAN	
2	MODEL			G20P-5	G25P-5	
3	CAPACITY	at rated load center	kg	2000	2500	
4	LOAD CENTER	distance	mm	500	500	
5	POWER TYPE	electric, diesel, gas, LPG-gas		lp	lp	
6	OPERATOR TYPE	stand-on, ride-seated		rider-seated	rider-seated	
7	TIRES	C=cushion, P=pneumatic		p	p	
8	WHEELS(x=driven)	number of front/rear		2/2	2/2	
DIMENSIONS						
9	LIFT WITH STD	maximum fork height with rated load	mm	3230	3230	
10	TWO-STAGE MAST	free lift	mm	152	152	
11	FORK CARRIAGE	ISO class		II	II	
12	FORKS	thickness x width x length	mm	40x100x1050	40x100x1050	
13		fork spacing (maximum x minimum)	mm	275x1035	275x1035	
14	TILT OF MAST	forward/backward	deg	6/10	6/10	
15	OVERALL DIMENSIONS	length without forks	mm	2530	2595	
16		width	mm	1170	1170	
17		mast lowered height	mm	2175	2175	
18		mast extended height	mm	4490	4490	
19		overhead guard height	mm	2183	2183	
20		seat height	mm	1026	1026	
21	OUTSIDE TURNING RADIUS		mm	2220	2265	
22	LOAD MOMENT CONSTANT		mm	480	480	
23	90° STACKING AISLE		mm	2700	2745	
23a	90° INTERSECTING AISLE		mm	1970	2000	
PERFORMANCE						
24	SPEED	travel, loaded/unloaded	km/hr	19/20	19/20	
25		lift, loaded/unloaded	mm/s	530/600	510/600	
26		lowering, loaded/unloaded	mm/s	510/460	510/460	
27	DRAWBAR PULL	at 1.6km/hr, loaded/unloaded	kg	1750	1725	
28	GRADEABILITY	at 1.6km/hr, loaded/unloaded	%	33	28	
29	ACCELERATION	time reached at max speed, loaded/unloaded	sec			
WEIGHT						
30	TOTAL WEIGHT at unloaded			kg	3570	3940
31	AXLE LOAD	at loaded, front/rear	kg	4940/630	5670/770	
32		at unloaded, front/rear	kg	1730/1840	1660/2280	
CHASSIS						
33	number of front/rear			2/2	2/2	
34	TIRES	front size		7.00x15-12	7.00x15-12	
35		rear size		6.50x10-10	6.50x10-10	
36	WHEEL BASE		mm	1625	1625	
37	TREAD	front/rear	mm	975/1000	975/1000	
38	GROUND CLEARANCE	at loaded, the lowest point	mm	115	115	
39		at loaded, center of wheelbase	mm	143	143	
40	SEVICE BRAKE			foot/hyd	foot/hyd	
41	PARKING BRAKE			hand/mech	hand/mech	
DRIVE						
42	BATTERY	voltage/capacity	V/AH	12/65	12/65	
43	ENGINE	manufacturer/model		G424F(E)	G424F(E)	
44		rated output / rpm	kw(hp)	47.7(64)/2550	47.7(64)/2550	
45		max. torque / rpm	N•m(lb•ft)	182(135)/2200	182(135)/2200	
46		cycle/cylinders/displacement	cc	4/4/2405	4/4/2405	
47	TRANSMISSION	type		powershift	powershift	
48		number of speeds forward/reverse		1/1	1/1	
49	OPERATING PRESSURE	system/attachment	bar	181/156	195/156	
50	NOISE LEVEL	equivalent continuous sound pressure level (Leq) at operator's ear (DI : BITA/CE prEN 12053)	dB(A)			

DOOSAN	DOOSAN	DOOSAN	
G30P-5	G33P-5	G35C-5	1
3000	3250	3500	2
500	500	500	3
lp	lp	lp	4
rider-seated	rider-seated	rider-seated	5
p	p	p	6
2/2	2/2	2/2	7
			8
			9
3230	3230	3000	10
152	152	152	11
III	III	III	12
45x125x1050	45x125x1050	45x125x1050	13
286x1044	286x1044	286x1044	14
6/10	6/10	6/10	15
2700	2730	2765	16
1197	1197	1255	17
2165	2165	2165	18
4490	4490	4260	19
2183	2183	2183	20
1026	1026	1026	21
2365	2395	2420	22
485	485	495	23
2850	2880	2915	24
2050	2100	2170	25a
			26
18/19	18/19	18.5/19.5	27
500/600	500/600	420/600	28
510/460	510/460	510/460	29
1815	1805	1735	30
25.5	24	21.5	31
			32
			33
4380	4560	4750	34
6310/1050	6890/920	7300/950	35
1800/2780	1760/2800	1750/3000	36
			37
2/2	2/2	2/2	38
28x9x15-12	28x9x15-12	250x15-18	39
6.50x10-10	6.50x10-12	6.50x10-12	40
1700	1700	1700	41
982/1000	982/1000	1026/1000	42
105	105	105	43
143	143	143	44
foot/hyd	foot/hyd	foot/hyd	45
hand/mech	hand/mech	hand/mech	46
			47
12/65	12/65	12/65	48
G424F(E)	G424F(E)	G424F(E)	49
47.7(64)/2550	47.7(64)/2550	47.7(64)/2550	50
182(135)/2200	182(135)/2200	182(135)/2200	
4/4/2405	4/4/2405	4/4/2405	
powershift	powershift	powershift	
1/1	1/1	1/1	
216/156	216/156	216/156	
			50

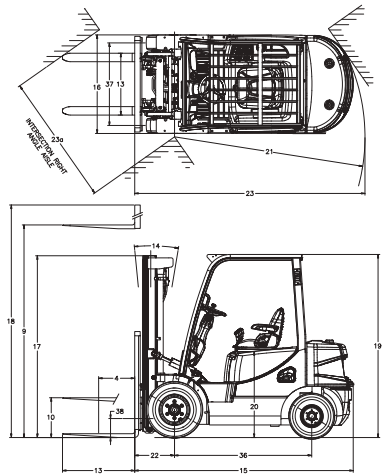

Specifications

CHARACTERISTICS			
1	MANUFACTURER		DOOSAN
2	MODEL		GC20E-5
3	CAPACITY	at rated load center	kg 2000
4	LOAD CENTER	distance	mm 500
5	POWER TYPE	electric, diesel, gas, LPG-gas	LP
6	OPERATOR TYPE	stand-on, ride-seated	ride-seated
7	TIRES	C=cushion, P=pneumatic	C
8	WHEELS(x=driven)	number of front/rear	2/2
DIMENSIONS			
9	LIFT WITH STD TWO-STAGE MAST	maximum fork height with rated load	mm 3230
10		free lift	mm 152
11	FORK CARRIAGE	ISO class	II
12	FORKS	thickness x width x length	mm 40x100x1050
13		fork spacing (maximum x minimum)	mm 297x905
14	TILT OF MAST	forward/backward	deg 6/8
15	OVERALL DIMENSIONS	length without forks	mm 2218
16		width	mm 1110
17		mast lowered height	mm 2130
18		mast extended height	mm 4480
19		overhead guard height	mm 2150
20		seat height	mm 1038
21	OUTSIDE TURNING RADIUS	mm 2000	
22	LOAD MOMENT CONSTANT	mm 367	
23	90. STACKING AISLE	mm 2367	
23a	90. INTERSECTING AISLE	mm 1798	
PERFORMANCE			
24	SPEED	travel, loaded/unloaded	km/hr 16/16
25		lift, loaded/unloaded	mm/s 530/600
26		lowering, loaded/unloaded	mm/s 510/460
27	DRAWBAR PULL	at 1.6km/hr, loaded/unloaded	kg 1795
28	GRADEABILITY	at 1.6km/hr, loaded/unloaded	% 35.5
29	ACCELERATION	time reached at max speed, loaded/unloaded	sec
WEIGHT			
30	TOTAL WEIGHT at unloaded	kg 3410	
31	AXLE LOAD	at loaded, front/rear	kg 4770/640
32		at unloaded, front/rear	kg 1540/1870
CHASSIS			
33	TIRES	number of front/rear	2/2
34		front size	21x7-15
35		rear size	16x5-10.5
36	WHEEL BASE	mm 1410	
37	TREAD	front/rear	mm 932/983
38	GROUND CLEARANCE	at loaded, the lowest point	mm 90
39		at loaded, center of wheelbase	mm 135
40	SEVICE BRAKE		foot/hyd
41	PARKING BRAKE		hand/mech
DRIVE			
42	BATTERY	voltage/capacity	V/AH 12/45
43	ENGINE	manufacturer/model	G420F(E)
44		rated output / rpm	kw(hp) 39.9(53.5)/2500
45		max. torque / rpm	N•m(lb•ft) 157(116)/1600
46		cycle/cylinders/displacement	cc 4/4/1975
47	TRANSMISSION	type	powershift
48		number of speeds forward/reverse	1/1
49	OPERATING PRESSURE	system/attachment	bar 181/156
50	NOISE LEVEL	equivalent continuous sound pressure level (Leq) at operator's ear (DI : BITA/CE prEN 12053)	dB(A)

DOOSAN	DOOSAN	DOOSAN		1
GC25E-5	GC30E-5	GC33E-5		2
2500	3000	3000(6500LBS)		3
500	500	600		4
LP	LP	LP		5
rider-seated	rider-seated	rider-seated		6
C	C	C		7
2/2	2/2	2/2		8
3230	3230	3230		9
152	152	152		10
II				11
40x100x1050	45x125x1050	45x125x1050		12
297x905	282x954	282x954		13
6/8	6/8	6/8		14
2268	2333	2368		15
1110	1110	1110		16
2130	2130	2130		17
4480	4480	4480		18
2150	2150	2150		19
1038	1038	1038		20
2045	2105	2135		21
367	373	373		22
2412	2478	2508		23
1822	1872	1907		23a
16/16	16/16	16/16		24
510/600	500/600	500/600		25
510/460	510/460	510/460		26
1775	1750	1740		27
30	25.5	23.5		28
				29
3710	4180	4350		30
5500/710	6330/850	6490/860		31
1460/2250	1470/2710	1420/2930		32
2/2	2/2	2/2		33
21x7-15	21x8-15	21x8-15		34
16x5-10.5	16x6-10.5	16x6-10.5		35
1410	1410	1410		36
932/983	907/956	907/956		37
90	90	90		38
135	135	135		39
foot/hyd	foot/hyd	foot/hyd		40
hand/mech	hand/mech	hand/mech		41
12/45	12/45	12/45		42
G420F(E)	G420F(E)	G420F(E)		43
39.9(53.5)/2500	39.9(53.5)/2500	39.9(53.5)/2500		44
157(116)/1600	157(116)/1600	157(116)/1600		45
4/4/1975	4/4/1975	4/4/1975		46
powershift	powershift	powershift		47
1/1	1/1	1/1		48
195/156	216/156	216/156		49
				50

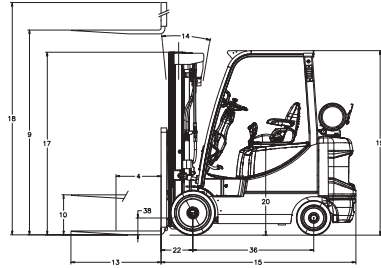
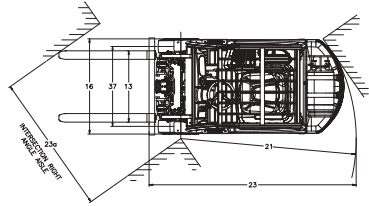

Specifications

CHARACTERISTICS			
1	MANUFACTURER		DOOSAN
2	MODEL		GC20P-5
3	CAPACITY	at rated load center	kg 2000
4	LOAD CENTER	distance	mm 500
5	POWER TYPE	electric, diesel, gas, LPG-gas	LP
6	OPERATOR TYPE	stand-on, ride-seated	ride-seated
7	TIRES	C=cushion, P=pneumatic	C
8	WHEELS(x=driven)	number of front/rear	2/2
DIMENSIONS			
9	LIFT WITH STD TWO-STAGE MAST	maximum fork height with rated load free lift	mm mm 3230 152
11	FORK CARRIAGE	ISO class	II
12	FORKS	thickness x width x length	mm 40x100x1050
13		fork spacing (maximum x minimum)	mm 297x905
14	TILT OF MAST	forward/backward	deg 6/8
15	OVERALL DIMENSIONS	length without forks	mm 2218
16		width	mm 1110
17		mast lowered height	mm 2130
18		mast extended height	mm 4480
19		overhead guard height	mm 2150
20		seat height	mm 1038
21	OUTSIDE TURNING RADIUS		mm 2000
22	LOAD MOMENT CONSTANT		mm 367
23	90.° STACKING AISLE		mm 2374
23a	90.° INTERSECTING AISLE		mm 1798
PERFORMANCE			
24	SPEED	travel, loaded/unloaded	km/hr 16/16
25		lift, loaded/unloaded	mm/s 530/600
26		lowering, loaded/unloaded	mm/s 510/460
27	DRAWBAR PULL	at 1.6km/hr, loaded/unloaded	kg 2170
28	GRADEABILITY	at 1.6km/hr, loaded/unloaded	% 44
29	ACCELERATION	time reached at max speed, loaded/unloaded	sec
WEIGHT			
30	TOTAL WEIGHT at unloaded		kg 3430
31	AXLE LOAD	at loaded, front/rear	kg 4780/650
32		at unloaded, front/rear	kg 1550/1880
CHASSIS			
33	TIRES	number of front/rear	2/2
34		front size	21x7-15
35		rear size	16x5-10.5
36	WHEEL BASE		mm 1410
37	TREAD	front/rear	mm 932/983
38	GROUND CLEARANCE	at loaded, the lowest point	mm 90
39		at loaded, center of wheelbase	mm 135
40	SEVICE BRAKE		foot/hyd
41	PARKING BRAKE		hand/mech
DRIVE			
42	BATTERY	voltage/capacity	V/AH 12/65
43	ENGINE	manufacturer/model	G424F(E)
44		rated output / rpm	kw(hp) 47.7(64)/2550
45		max. torque / rpm	N•m(lb•ft) 182(135)/2200
46		cycle/cylinders/displacement	cc 4/4/2405
47	TRANSMISSION	type	powershift
48		number of speeds forward/reverse	1/1
49	OPERATING PRESSURE	system/attachment	bar 181/156
50	NOISE LEVEL	equivalent continuous sound pressure level (Leq) at operator's ear (DI : BITA/CE prEN 12053)	dB(A)

			1
DOOSAN	DOOSAN	DOOSAN	
GC25P-5	GC30P-5	GC33P-5	2
2500	3000	3000(6500LBS)	3
500	500	600	4
LP	LP	LP	5
rider-seated	rider-seated	rider-seated	6
C	C	C	7
2/2	2/2	2/2	8
3230	3230	3230	9
152	152	152	10
II	III	III	11
40x100x1050	45x125x1050	45x125x1050	12
297x905	282x954	282x954	13
6/8	6/8	6/8	14
2268	2333	2368	15
1110	1110	1110	16
2130	2130	2130	17
4480	4480	4480	18
2150	2150	2150	19
1038	1038	1038	20
2045	2105	2135	21
367	373	373	22
2419	2479	2509	23
1822	1872	1907	23a
16/16	16/16	16/16	24
510/600	500/600	500/600	25
510/460	510/460	510/460	26
2050	2125	2115	27
37	31	29	28
			29
3730	4200	4370	30
5510/720	6340/860	6500/870	31
1470/2260	1490/2710	1430/2940	32
2/2	2/2	2/2	33
21x7-15	21x8-15	21x8-15	34
16x5-10.5	16x6-10.5	16x6-10.5	35
1410	1410	1410	36
932/983	907/956	907/956	37
90	90	90	38
135	135	135	39
foot/hyd	foot/hyd	foot/hyd	40
hand/mech	hand/mech	hand/mech	41
12/65	12/65	12/65	42
G424F(E)	G424F(E)	G424F(E)	43
47.7(64)/2550	47.7(64)/2550	47.7(64)/2550	44
182(135)/2200	182(135)/2200	182(135)/2200	45
4/4/2405	4/4/2405	4/4/2405	46
powershift	powershift	powershift	47
1/1	1/1	1/1	48
195/156	216/156	216/156	49
			50

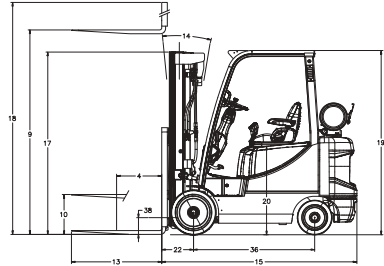
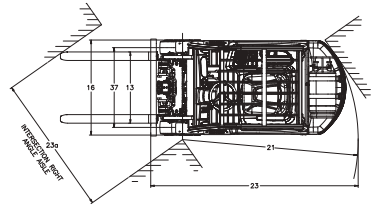

Noise and Vibration

Model	Sound Pressure Level at Operator's ear (Leq.) according to EN12053 Guaranteed Sound	Power level(L _{WA}) By Noise Directive 2000/14/EC	Whole-body Vibration Level according to EN13059 (m/s ²)	
	dB(A)	dB(A)	Mean	Uncertainty
TIER - II (4TNV98 E/G) D20S-5,D25S-5,D30S-5, D33S-5, D35C-5 (W/O Cabin)	82	104	0.7	0.2
TIER - III (4TNE98 E/G) D20S-5,D25S-5,D30S-5, D33S-5, D35C-5 (W/O Cabin)	82	104		
TIER - III (G420F(E) E/G) G20E-5,G25E-5,G30E-5 (W/O Cabin)	82	104		
TIER - III (G424F(E) E/G) G20P-5,G25P-5,G30P-5, G33P-5,G35C-5 (W/O Cabin)	84	106	1.1	0.3
TIER - III (G420F(E) E/G) GC20E-5,GC25E-5,GC30E-5, GC33E-5 (W/O Cabin)	80	*NA		
TIER - III (G424F(E) E/G) GC20P-5,GC25P-5,GC30P-5, GC33P-5 (W/O Cabin)	82	*NA		

* NA : Not Applicable

Capacity Chart (Without Sideshifter Pneumatic)

MODEL	SINGLE TIRE	
	STD, FFL	FFT
D20S-5, G20E-5, G20P-5	<p>A. 2030-4350mm MFH MAST B. 4960mm MFH MAST</p>	<p>A. 3900-4290mm MFH MAST B. 4730mm MFH MAST C. 5560mm MFH MAST D. 6010mm MFH MAST</p>
	<p>A. 2030-4350mm MFH MAST B. 4960mm MFH MAST</p>	<p>A. 3900-4290mm MFH MAST B. 4730mm MFH MAST C. 5560mm MFH MAST D. 6010mm MFH MAST</p>
D30S-5, G30E-5, G30P-5	<p>A. 2030-4350mm MFH MAST B. 4960mm MFH MAST</p>	<p>A. 3900-4730mm MFH MAST B. 5560mm MFH MAST C. 6010mm MFH MAST</p>

Capacity Chart (Without Sideshifter Pneumatic)

MODEL	SINGLE TIRE	
	STD, FFL	FFT
D33S-5, G33P-5	<p>A. 2030-3800mm MFH MAST B. 3950-4350mm MFH MAST C. 4960mm MFH MAST</p>	<p>A. 3900-4290mm MFH MAST B. 4730mm MFH MAST C. 5560mm MFH MAST D. 6010mm MFH MAST</p>
	<p>A. 1800-3805mm MFH MAST B. 4205mm MFH MAST C. 4805mm MFH MAST</p>	<p>A. 3555-3960mm MFH MAST B. 4380mm MFH MAST C. 4820mm MFH MAST D. 5205mm MFH MAST E. 5655mm MFH MAST</p>

Capacity Chart (Without Sideshifter Pneumatic)

MODEL	DOUBLE TIRE	
	STD, FFL	FFT
D20S-5, G20E-5, G20P-5	<p>A. 2030-4350mm MFH MAST B. 4960mm MFH MAST</p>	<p>A. 3900-4290mm MFH MAST B. 4730mm MFH MAST C. 5560mm MFH MAST D. 6010mm MFH MAST</p>
	<p>A. 2030-4350mm MFH MAST B. 4960mm MFH MAST</p>	<p>A. 3900-4730mm MFH MAST B. 5560mm MFH MAST C. 6010mm MFH MAST</p>
D30S-5, G30E-5, G30P-5	<p>A. 2030-4350mm MFH MAST B. 4960mm MFH MAST</p>	<p>A. 3900-4730mm MFH MAST B. 5560mm MFH MAST C. 6010mm MFH MAST</p>

Capacity Chart (Without Sideshifter Pneumatic)

MODEL	DOUBLE TIRE	
	STD, FFL	FFT
D33S-5, G33P-5	<p>A. 2030-4350mm MFH MAST B. 4960mm MFH MAST</p>	<p>A. 3900-4290mm MFH MAST B. 4730mm MFH MAST C. 5560mm MFH MAST D. 6010mm MFH MAST</p>
	<p>A. 1800-3805mm MFH MAST B. 4205mm MFH MAST C. 4805mm MFH MAST</p>	<p>A. 3555-3960mm MFH MAST B. 4380mm MFH MAST C. 4820mm MFH MAST D. 5205mm MFH MAST E. 5655mm MFH MAST</p>

Capacity Chart (With Sideshifter Pneumatic)

MODEL	SINGLE TIRE	
	STD, FFL	FFT
D20S-5, G20E-5, G20P-5	<p>A. 2300–3950mm MFH MAST B. 4350mm MFH MAST C. 4960mm MFH MAST</p>	<p>A. 3900mm MFH MAST B. 4290mm MFH MAST C. 4730mm MFH MAST D. 5560mm MFH MAST E. 6010mm MFH MAST</p>
	<p>A. 2030–3950mm MFH MAST B. 4350mm MFH MAST C. 4960mm MFH MAST</p>	<p>A. 3900mm MFH MAST B. 4290mm NFH MAST C. 4730mm NFH MAST D. 5560mm NFH MAST E. 6010mm MFH MAST</p>
D30S-5, G30E-5, G30P-5	<p>A. 2030–3950mm MFH MAST B. 4350mm MFH MAST C. 4960mm MFH MAST</p>	<p>A. 3900mm NFH MAST B. 4290mm MFH MAST C. 4730mm MFH MAST D. 5560mm MFH MAST E. 6010mm MFH MAST</p>

Capacity Chart (With Sideshifter Pneumatic)

MODEL	SINGLE TIRE	
	STD, FFL	FFT
D335-5, G33P-5	<p>A. 2030-3800mm MFH MAST B. 3950mm MFH MAST C. 4350mm MFH MAST D. 4960mm MFH MAST</p>	<p>A. 3900mm MFH MAST B. 4290mm MFH MAST C. 4730mm MFH MAST D. 5560mm MFH MAST E. 6010mm MFH MAST</p>
	<p>A. 1800-3800mm MFH MAST B. 4205mm MFH MAST C. 4805mm MFH MAST</p>	<p>A. 3555-3960mm MFH MAST B. 4380mm MFH MAST C. 4820mm MFH MAST D. 5205mm MFH MAST E. 5655mm MFH MAST</p>

Capacity Chart (With Sideshifter Pneumatic)

MODEL	DOUBLE TIRE	
	STD, FFL	FFT
D20S-5, G20E-5, G20P-5	<p>A. 2030-3950mm MFH MAST B. 4350mm MFH MAST C. 4960mm MFH MAST</p>	<p>A. 3900mm MFH MAST B. 4290mm MFH MAST C. 4730mm MFH MAST D. 5560mm MFH MAST E. 6010mm MFH MAST</p>
	<p>A. 2030-3950mm MFH MAST B. 4350mm MFH MAST C. 4960mm MFH MAST</p>	<p>A. 3900mm MFH MAST B. 4290mm MFH MAST C. 4730mm MFH MAST D. 5560mm MFH MAST E. 6010mm MFH MAST</p>
D30S-5, G30E-5, G30P-5	<p>A. 2030-3950mm MFH MAST B. 4350mm MFH MAST C. 4980mm MFH MAST</p>	<p>A. 3900mm MFH MAST B. 4290mm MFH MAST C. 4730mm MFH MAST D. 5560mm MFH MAST E. 6010mm MFH MAST</p>

Capacity Chart (With Sideshifter Pneumatic)

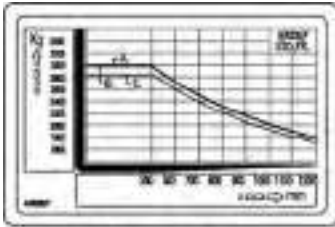
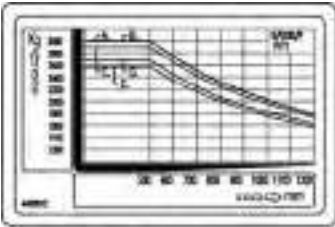
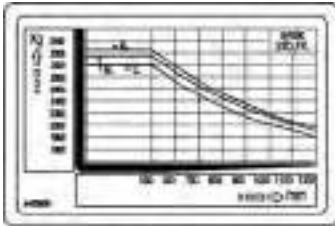
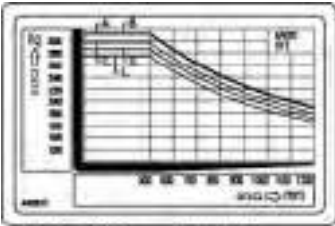
MODEL	DOUBLE TIRE	
	STD, FFL	FFT
D33S-5, G33P-5	 <p>A. 2030-3950mm MFH MAST B. 4350mm MFH MAST C. 4960mm MFH MAST</p>	 <p>A. 3900mm MFH MAST B. 4290mm MFH MAST C. 4730mm MFH MAST D. 5560mm MFH MAST E. 8010mm MFH MAST</p>
	 <p>A. 1800-3805mm MFH MAST B. 4205mm MFH MAST C. 4805mm MFH MAST</p>	 <p>A. 3555-3960mm MFH MAST B. 4380mm MFH MAST C. 4820mm MFH MAST D. 5205mm MFH MAST E. 5855mm MFH MAST</p>

Capacity Chart (Without Sideshifter cushion)

MODEL	NARROW TIRE	
	STD, FFL	FFT
GC20E-5, GC20P-5	<p>A. 2030–4350mm MFH MAST B. 4960mm MFH MAST</p>	<p>A. 3900–4290mm MFH MAST B. 4730mm MFH MAST C. 5560mm MFH MAST D. 6010mm MFH MAST</p>
	<p>A. 2030–4350mm MFH MAST B. 4960mm MFH MAST</p>	<p>A. 3900mm MFH MAST B. 4290mm MFH MAST C. 4730mm MFH MAST D. 5560mm MFH MAST E. 6010mm MFH MAST</p>
GC30E-5, GC30P-5	<p>A. 2030–3950mm MFH MAST B. 4350mm MFH MAST C. 4960mm MFH MAST</p>	<p>A. 3900–4290mm MFH MAST B. 4730mm MFH MAST C. 5560mm MFH MAST D. 6010mm MFH MAST</p>

Capacity Chart (Without Sideshifter cushion)

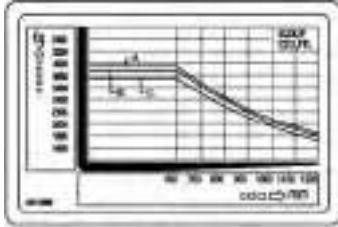
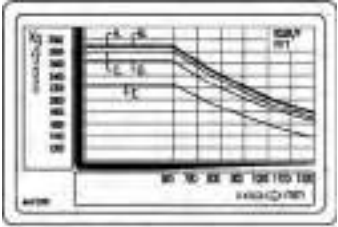
MODEL	NARROW TIRE	
	STD, FFL	FFT
GC33E-5, GC33P-5	 <p>A. 2030-3950mm MFH MAST B. 4350mm MFH MAST C. 4960mm MFH MAST</p>	 <p>A. 3900mm MFH MAST B. 4290mm MFH MAST C. 4730mm MFH MAST D. 5560mm MFH MAST E. 6010mm MFH MAST</p>

Capacity Chart (Without Sideshifter cushion)

MODEL	WIDE TIRE	
	STD, FFL	FFT
GC20E-5, GC20P-5	<p>A. 2030-4350mm MFH MAST B. 4960mm MFH MAST</p>	<p>A. 3900-4290mm MFH MAST B. 4730mm MFH MAST C. 5560mm MFH MAST D. 6010mm MFH MAST</p>
	<p>A. 2030-3950mm MFH MAST B. 4350mm MFH MAST C. 4960mm MFH MAST</p>	<p>A. 3900mm MFH MAST B. 4290mm MFH MAST C. 4730mm MFH MAST D. 5560mm MFH MAST E. 6010mm MFH MAST</p>
GC30E-5, GC30P-5	<p>A. 2030-3950mm MFH MAST B. 4350mm MFH MAST C. 4960mm MFH MAST</p>	<p>A. 3900-4290mm MFH MAST B. 4730mm MFH MAST C. 5560mm MFH MAST D. 6010mm MFH MAST</p>

Capacity Chart (Without Sideshifter cushion)

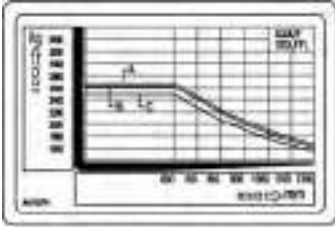
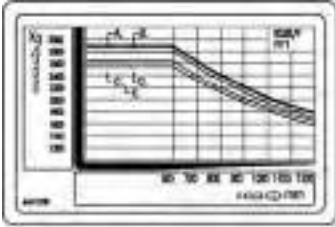
MODEL	WIDE TIRE	
	STD, FFL	FFT
GC33E-5, GC33P-5	 <p>A. 2030-3950mm MFH MAST B. 4350mm MFH MAST C. 4960mm MFH MAST</p>	 <p>A. 3900mm MFH MAST B. 4290mm MFH MAST C. 4730mm MFH MAST D. 5560mm MFH MAST E. 6D10mm MFH MAST</p>

Capacity Chart (With Sideshifter cushion)

MODEL	NARROW TIRE	
	STD, FFL	FFT
GC20E-5, GC20P-5	<p>A. 2030-3950mm MFH MAST B. 4350mm MFH MAST C. 4960mm MFH MAST</p>	<p>A. 3900mm MFH MAST B. 4290mm MFH MAST C. 4730mm MFH MAST D. 5560mm MFH MAST E. 6010mm MFH MAST</p>
	<p>A. 2030-3950mm MFH MAST B. 4350mm MFH MAST C. 4960mm MFH MAST</p>	<p>A. 3900mm MFH MAST B. 4290mm MFH MAST C. 4730mm MFH MAST D. 5560mm MFH MAST E. 6010mm MFH MAST</p>
GC30E-5, GC30P-5	<p>A. 2030-3950mm MFH MAST B. 4350mm MFH MAST C. 4960mm MFH MAST</p>	<p>A. 3900mm MFH MAST B. 4290mm MFH MAST C. 4730mm MFH MAST D. 5560mm MFH MAST E. 6010mm MFH MAST</p>

Capacity Chart (With Sideshifter cushion)

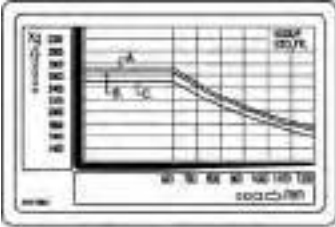
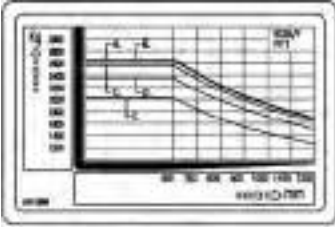
MODEL	NARROW TIRE	
	STD, FFL	FFT
GC33E-5, GC33P-5	 <p>A. 2030-3950mm MFH MAST B. 4350mm MFH MAST C. 4960mm MFH MAST</p>	 <p>A. 3900mm MFH MAST B. 4290mm MFH MAST C. 4730mm MFH MAST D. 5560mm MFH MAST E. 6010mm MFH MAST</p>

Capacity Chart (With Sideshifter cushion)

MODEL	WIDE TIRE	
	STD, FFL	FFT
GC20E-5, GC20P-5	<p>A. 2030-3950mm MFH MAST B. 4350mm MFH MAST C. 4960mm MFH MAST</p>	<p>A. 3900mm MFH MAST B. 4290mm MFH MAST C. 4730mm MFH MAST D. 5560mm MFH MAST E. 6010mm MFH MAST</p>
	<p>A. 2030-3950mm MFH MAST B. 4350mm MFH MAST C. 4960mm MFH MAST</p>	<p>A. 3900mm MFH MAST B. 4290mm MFH MAST C. 4730mm MFH MAST D. 5560mm MFH MAST E. 6010mm MFH MAST</p>
GC30E-5, GC30P-5	<p>A. 2030-3950mm MFH MAST B. 4350mm MFH MAST C. 4960mm MFH MAST</p>	<p>A. 3900mm MFH MAST B. 4290mm MFH MAST C. 4730mm MFH MAST D. 5560mm MFH MAST E. 6010mm MFH MAST</p>

Capacity Chart (With Sideshifter cushion)

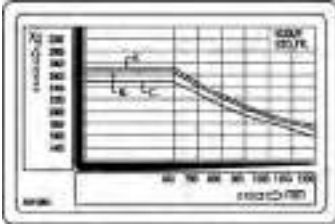
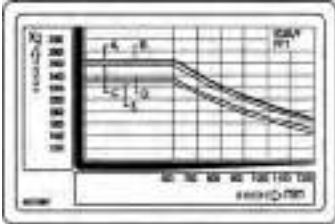
MODEL	WIDE TIRE	
	STD, FFL	FFT
GC33E-5, GC33P-5	 <p>A. 2030-3950mm MFH MAST B. 4350mm MFH MAST C. 4960mm MFH MAST</p>	 <p>A. 3900mm MFH MAST B. 4290mm MFH MAST C. 4730mm MFH MAST D. 5560mm MFH MAST E. 6010mm MFH MAST</p>

Serial Number

Serial Number Locations

For quick reference, record your lift truck's serial numbers in the spaces provided below the photographs.



Lift Truck Serial Number

• _____



3.3 liter Diesel Engine (4TNV98) Serial Number

• _____

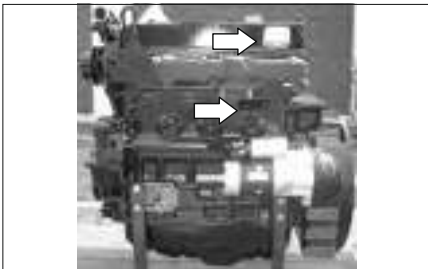

3.3 liter Diesel Engine (4TNE98) Serial Number

• _____

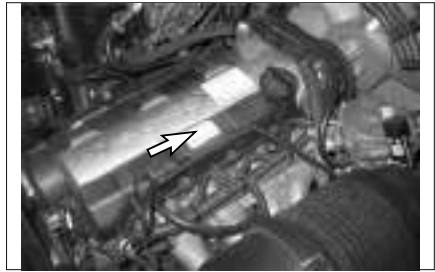

2.0 liter Spark-Ignition Engine Serial Number (G420F(E))

• _____

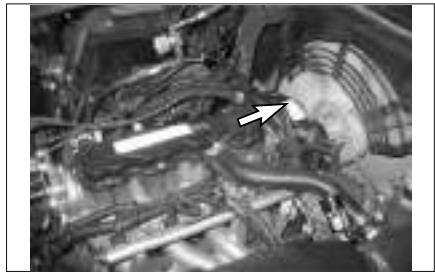

2.4 liter Spark-Ignition Engine Serial Number (G424F(E))

• _____



Power Shift Transmission Serial Number

• _____



Drive Axle Serial Number

• _____



Typical Example

Side Shifter Serial Number (If Equipped)

• _____

Attachment Abbreviations (Includes Special Forks)

SC	-Special Carriage-increased width, height or outreach
SSS	-Shaft-type Sideshift Carriage
HSS	-Hook-type Sideshift Carriage (ITA)
CW	-Counterweight
SF	-Special Forks
SWS	-Swing Shift, Sideshift
RAM	-Ram or Boom
DBCBH	-Double Cube Block Handler
HFP	-Hydraulic Fork Positioner
CR	-Crane Arm or Crane Boom
TH	-Tire Handler
CTH	-Container Handler
LPP	-Load Push-Pull Device
CC	-Carton Clamp
RC	-Roll Clamp
LS	-Load Stabilizer
PWH	-Pulp Wood Handler
SS-ST	Sideshift-Side Tilt Carriage

Operator's Warning and Identification Plate

Familiarize yourself with the OPERATOR'S WARNING PLATE and IDENTIFICATION, LIFT CAPACITY and ATTACHMENT PLATES. DO NOT exceed capacity as equipped load ratings.

Operator's Warning Plate



Located on the right side of the operator's seat.

Identification, Lift Capacity and Attachment Plate



Located on the cowl to the right side of the steering column.

If Convenience Package Equipped



Located on the overhead guard.

Below are abbreviations that may appear on the IDENTIFICATION, LIFT CAPACITY and ATTACHMENT PLATES and their meanings.

Mast Abbreviations

- STD - Standard Mast (single inner member, low free lift)
- FF - Full Free Lift Mast (single inner member with high free lift duplex cylinder)
- FFT - Triple Lift Mast (two inner members with either low or full free lift characteristics).
- QUAD - Quadruple (Quad) Mast (with three inner members)

NOTE: When only a mast-type is listed on the identification plate, a standard carriage and forks are used.

Operator's Station and Monitoring Systems

Instrument Panel

Your lift truck may not have the same indicator or warning lights as shown in the illustrations. Due to the various options available, typical instrument panels are shown.

However, the symbols on the indicators and lights on your panel identify what those particular items are. Also, the symbol for each of the items is identified and an explanation of their function and location is described on the following pages.

Diesel (12V)

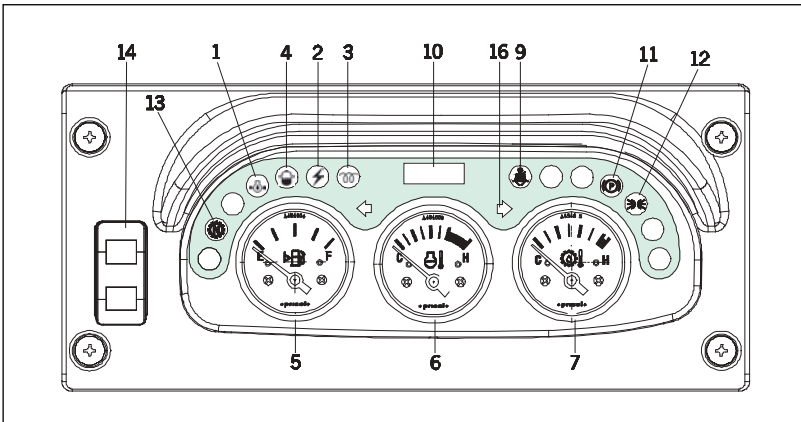

LPG/GAS (12V)

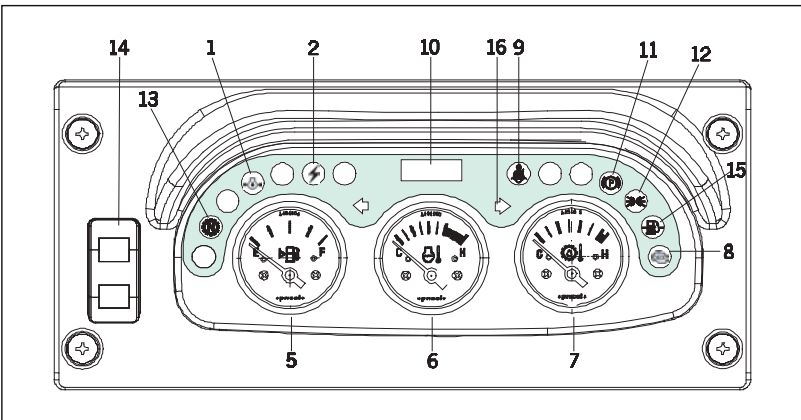



1. Engine Oil Pressure Indicator Light - Indicates insufficient engine oil pressure. The light will come on when the ignition switch is turned to the ON position. The light should go off after the engine is started. If the light turns on while operating the lift truck, insufficient engine oil pressure is indicated. Park the lift truck and stop the engine.



2. Alternator Indicator Light - Indicates if the battery charging system is operational. The light will come on when the ignition switch is turned to the ON position.

The light should go off after the engine is started, indicating the alternator is producing sufficient voltage to charge the battery. If the light turns on with the engine running, check the alternator charging system for a malfunction.



3. Diesel Engine Start Preheat Indicator Light - The light will come ON when the key is turned to the ON position from the OFF position. This indicates that the glow plugs are preheating the pre-combustion chambers for easier starting.

The amount of time needed to preheat the pre-combustion chambers is approximately seven seconds, depending on the surrounding air temperature. When the light goes OFF the maximum pre-combustion chamber temperature has been reached and the key can be turned to the START position to start the engine.



4. Diesel Engine Water in Fuel Filter Indicator Light - Indicates when the engine is running, there is water in the fuel filter exceeds 100cc.

The light will come ON when the ignition switch is turned to the ON position. The light should go off after the engine is started. If the light turns on with the engine running, park the lift truck and stop the engine. Drain some fuel (and any water) until clean fuel flows from the filter which approximately takes 5 to 6 seconds



5. Fuel Level Gauge - Indicates fuel level (Gas, Diesel, or Dual Fuel Trucks Only)



6. Engine Coolant Temperature Gauge - Indicates coolant temperature. If both tenth & ninth flash out of phase while operating the lift truck, overheating is indicated. Park the lift truck and stop the engine.

Check the cooling system for a malfunction. Both tenth & ninth will flash out of phase when the coolant temperature reaches approximately 106°C (223°F) on all engines.



7. Transmission Oil Temperature Gauge - Indicates transmission oil temperature. If both tenth & ninth flash out of phase while operating the lift truck, excessive transmission oil temperature is indicated. Park the lift truck and stop the engine.



8. G420F(E)/G424F(E) Engine Malfunction Indicator Lamp (MIL)
G420F(E) and G424F(E) engine control systems are equipped with built-in fault diagnostics. Detected system faults can be displayed by the Malfunction Indicator Lamp (MIL) as Diagnostic Fault Codes (DFC) or flash codes, and viewed in detail with the use of service tool software. When the ignition key is turned ON the MIL will perform a self-test, illuminate once and then go OFF. If a detected fault condition exists, the fault or faults will be stored in the memory of the engine control module (ECM). Once a fault occurs the MIL will illuminate and remain ON. This signals the operator that a fault has been detected by the SECM.



9. Seat Belt Warning Light (If Equipment)
Indicates when the seat belt dose not fastened by operator. The light will come on when the ignition switch is turned to the on position. The light should go off after engine is started.



10. Service hour Meter - Indicates the total number of hours the engine and the lift truck have operated. The hour meter will operate when the ignition switch is in the ON position, whether the engine is running or not. The hour meter is used to determine lubrication and maintenance intervals.



11. Parking indicator light- The light will come ON when the parking lever is applied.



12. Front Floodlights- Push down on the switch(14), to the first step, to turn the front floodlights on.

Front and Rear Floodlights – Push down on the switch(14), to the second step, to turn both the front and rear floodlights on. The floodlights are optional.



13. Transmission Neutral Position Light - Indicates the neutral position of transmission.



14. Front and Rear Floodlights Switch – The front floodlight is ON when push down switch to the first step.

The front and rear floodlights are ON when push down switch to the second step.



15. Low Level Light of LP GAS – Indicates the low Level of LP GAS (LP or DUAL only)



16. Directional Turning Indicator Light

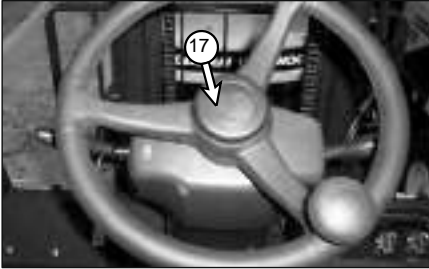

17. Horn Switch - Push on the horn button to sound the horn.

Electrical Disconnect Switch (If Equipped)

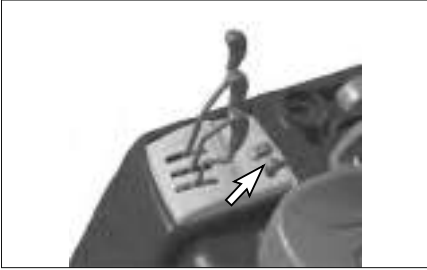

1. ON - Connects the battery for electrical power to all electrical circuits.



2. OFF - Disconnects the battery from all electrical circuits.

Engine Compartment

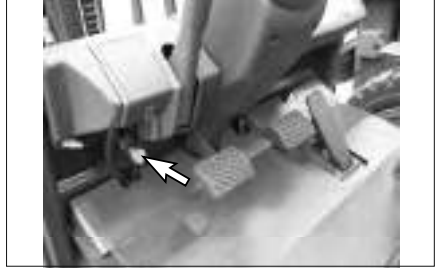

1. The engine compartment is accessible by pulling the latch (GC Series), or pushing down the lever located at cowl (G.D Series) and raising the hood and seat assembly (Note: Unlock latch before pulling-if key equipped)



2. The hood and seat assembly is held up by a support cylinder. Make certain the air cylinder is operating properly and securely hold the hood up before doing anything in the engine compartment.

Seat Switch System (If Equipped)



The lift truck is equipped with a SEAT SWITCH SYSTEM. In normal operation if the direction lever is placed in either forward or reverse, the lift truck will move at a speed proportional to the accelerator pedal's position. If the operator leaves the seat without setting the parking brake, within three seconds after leaving the seat, the SEAT SWITCH SYSTEM will automatically disengage the transmission. The directional lever, however, will remain in that forward or reverse location although internally the transmission will have shifted into neutral.

Before exiting the lift truck, the parking brake should always be applied.

WARNING

WHEN LEAVING MACHINE APPLY PARKING BRAKE!

PARKING BRAKE IS NOT AUTOMATICALLY APPLIED.

NOTE: Some trucks may be equipped (ask your dealer if this applies to your truck) with an alarm that will sound if the parking brake is not applied when leaving the machine.

NOTICE

Prior to operating the lift truck, be sure to understand and check the SEAT SWITCH SYSTEM.

While in normal operation and on level ground, select a direction with the directional lever and with the park brake released. You will note that the truck will move slowly in the selected direction. If you lift yours hips off of the seat, within three seconds, the SEAT SWITCH SYSTEM will disengage the transmission allowing the truck to coast but not automatically stop.

To restore the lift truck to normal operation, while sitting in the operator's seat depress the brake pedal to hold the lift truck, return the directional lever to the neutral position, and then reselect a direction of travel (either forward or reverse). The transmission will then re-engage.

If seat or seat switch replacement becomes necessary, be sure to use genuine DOOSAN Infracore lift truck parts. Lift trucks should never be operated without an operational SEAT SWITCH SYSTEM.

⚠ WARNING

When closing the engine hood, be careful not to pinch your hand.

Circuit Breaker



Circuit Breaker -Protects the main electrical circuits. To reset the circuit breaker, push the button in. Located in the engine compartment.

Seat

NOTE: Seat arrangements may vary. Basic operation will be similar.

Seat adjustment should be checked at the beginning of each shift and when operators change.

Lock the seat into position before operating, to prevent an unexpected seat change.

Adjust seat to allow full brake pedal travel with operator's back against seat back.



NOTE: The seat can only be correctly adjusted with the operator fully seated.

Tilt Steering Column



To adjust the steering column, push down the knob(1), and move the steering column to the desired position, then release the knob(1).

Fuel Selector Switch (G420F(E)/G424F(E) Dual Fuel Only)

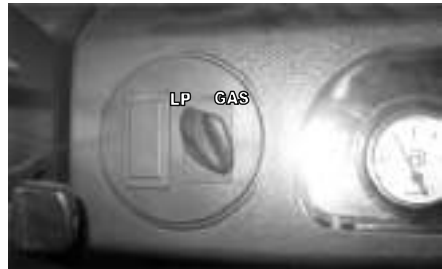

1. LPG - This position supplies electrical power to the LP fuellock solenoid, when the ignition switch is in the ON or the START position.

With the LP fuel tank valve open, LP can then flow the tank through the converter to the carburetor.



2. OFF – This position shuts off all fuel supply to the carburetor/injector.



3. GAS - This position supplies electrical power to gasoline fuel pump and injector. This will allow gasoline fuel to flow from the tank through the fuel filter and fuel pump to the injector.

Lift Truck Controls

Direction Control Lever



1. Forward - Push the lever forward for FORWARD direction travel.



2. Neutral - Move the lever to center position for NEUTRAL.



3. Reverse - Pull the lever back for REVERSE direction travel.

Transmission Inching Control Pedal



Inching Control Pedal - Pushing down on the inching pedal, modulates the hydraulic pressure to the clutch packs, permitting disc slippage.

Further pushing on the pedal completely relieves clutch pack pressure and applies the service brakes to stop and hold the lift truck.

NOTE: The purpose of the inching control pedal is to provide precise inching control at slow travel speed, with high engine rpm. This is used for fast hydraulic lift during load approach, pickup or positioning.

Service Brake Pedal

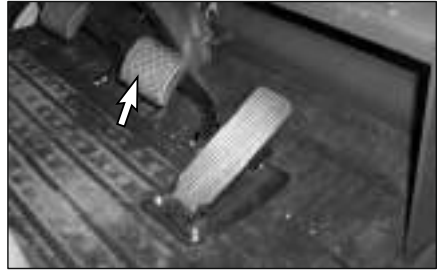

Push DOWN on the brake pedal to slow or stop the lift truck.



RELEASE the brake pedal to allow the lift truck to move.

Accelerator Pedal



Push DOWN on the pedal to increase engine rpm (speed).



RELEASE the pedal to decrease engine rpm (speed).

Parking Brake Lever

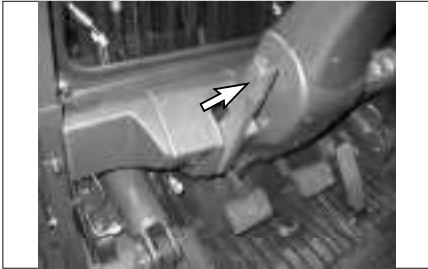

Pull the lever BACK to engage the parking brake.



Push the lever FORWARD to release the parking brake.

Lift Control

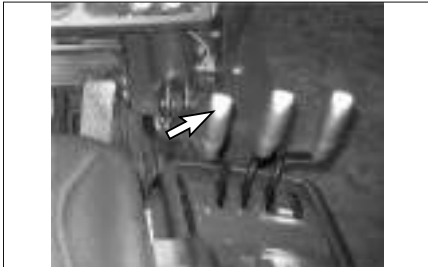

NOTE: To prevent a sudden change of position of the load, operate all lift, tilt and attachment controls smoothly.



1. Lower Position - Push the lever FORWARD smoothly to lower the load.



2. Hold Position - When the lever is released it will return to the HOLD or center position. Lifting or lowering action will stop.



3. Lift Position - Pull the lever BACK smoothly to lift the load.

Tilt Control

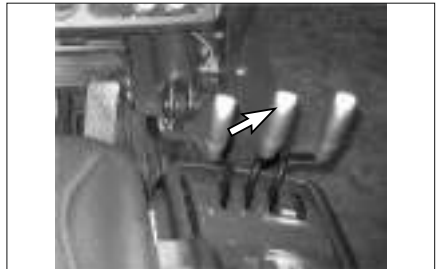

1. Mast Tilt Forward - Push the lever FORWARD smoothly to tilt the mast forward.



2. Mast Hold - When the lever is released it will return to the HOLD or center position. Tilting action will stop.



3. Mast Tilt Back - Pull the lever BACK smoothly to tilt the mast backward.

Sideshift Attachment (If Equipped)



1. Sideshift Left - Push the lever FORWARD to shift the carriage to the left.



2. Sideshift Hold - When the lever is released it will return to the HOLD or center position. Sideshifting action will stop.



3. Sideshift Right - Pull the lever BACK to shift the carriage to the right.

Refueling

Gasoline or Diesel Engine Equipped

WARNING

Explosive fumes may be present during refueling.

Do not smoke in refueling areas.

Lift truck should be refueled only at designated safe locations. Safe outdoor locations are preferable to those indoors.

Stop the engine and get off the lift truck during refueling.

NOTICE

Do not allow the lift truck to become low on fuel or completely run out of fuel. Sediment or other impurities in the fuel tank could be drawn into the fuel system. This could result in difficult starting or damage to components.

Fill the fuel tank at the end of each day of operation to drive out moisture laden air and to prevent condensation.

In the cold weather, the moisture condensation can cause rust in the fuel system and hard starting due to its freezing

Do not fill the tank to the top. Fuel expands when it gets warm and may overflow.



1. Park the lift truck only at a designated safe location. Place the transmission in NEUTRAL. Lower the forks to the ground. Engage the parking brake. Stop the engine.



2. Open the filter cap.
3. Fill the fuel tank slowly. Close the filter cap. If spillage occurs, wipe off excess fuel and wash down area with water.

NOTE: Drain water and sediment from fuel tank as required by prevailing conditions. Also, drain water and sediment from the main fuel storage tank weekly and before the tank is refilled. This will help prevent water or sediment being pumped from the storage tank into the lift truck fuel tank.

Changing LP Tanks

WARNING

Only trained, authorized personnel should fill or exchange LP tanks.

Personnel engaged in filling of LP containers should wear protective clothing such as face shield, long sleeves and gauntlet gloves.

Do not refuel or store LP powered lift trucks near any underground entrance, elevator shafts or any other place where LP could collect in a pocket causing a potentially dangerous condition.

Examine all LP containers before filling and again before reuse, for damage to various valves, liquid gauge, fittings and hand valve wheels.

All defective or damaged LP containers must be removed from service.

Explosive fumes may be present during refueling.

Do not smoke in refueling areas.

Lift truck should be refueled only at designated safe locations. Safe outdoor locations are preferable to indoor locations.

Stop the engine and get off the lift truck during refueling.

The careless handling of LP containers can result in a serious accident.

Use extreme care when transporting containers to prevent damage to them.

1. Park the lift truck on level ground, with the parking brake applied, the transmission in NEUTRAL, the forks lowered and the engine running at low idle.

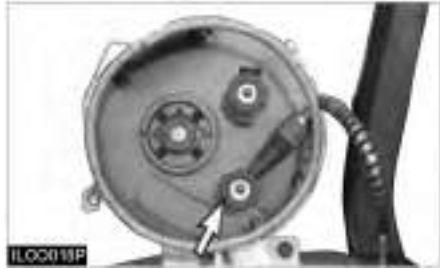

2. Close the fuel shut off valve at the LP tank. Run the engine until it stops, then turn off the ignition switch and the disconnect switch (if equipped).
3. Disconnect the fuel supply line.

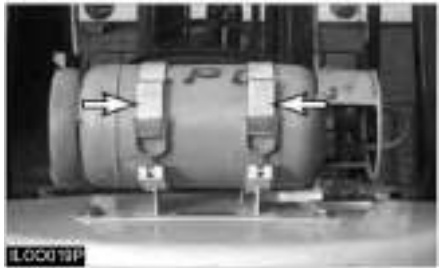

If Swing out type LP-Cradle Equipped



4. Loosen the retaining clamps and remove the tank.
5. Check the mounting to be sure the locating pin (dowel) is not missing or broken.

NOTICE

If the location pin (dowel) is missing or broken, be sure the pin is replaced.



6. Check to be sure that the LP warning plate is in position on the lift truck, and is legible.
7. Check to be sure the replacement tank is of the correct type.
8. Inspect the replacement tank for damage such as dents, scrapes or gouges and for indication of leakage at valves or threaded connections.

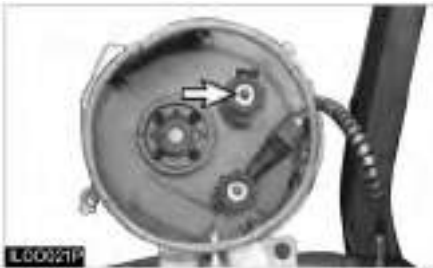

9. Check for debris in the relief valve, for damage to various valves and liquid level gauge.
10. Inspect the quick - disconnect couplings for deterioration, damage or missing flexible seals.

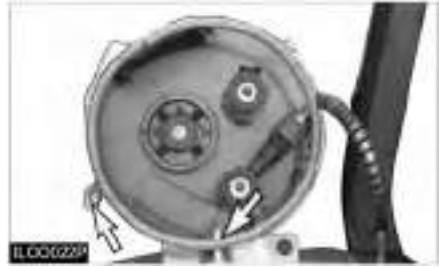

11. Position the replacement tank so that the locating pin (dowel) is in place.

⚠ WARNING

The LP tank must not extend past the counterweight

12. Clamp the tank securely.
13. Connect the fuel supply line.
14. Open the fuel valve by slowly turning it counterclockwise. If the fuel valve is opened too quickly, a back pressure check valve will shut off the fuel supply. If this happens, close the fuel valve completely. Wait five seconds and then open the fuel valve very slowly.
15. Inspect the LP fuel lines and fittings with a soap solution after filling the tank or when looking for leaks.

Before Starting the Engine

Walk - Around Inspection

Make a thorough walk - around inspection before mounting the lift truck or starting the engine. Look for such items as loose bolts, debris buildup, oil or coolant leaks. Check condition of tires, mast, carriage, forks or attachments. Have repairs made as needed and all debris removed.



1. Inspect the operator's compartment for loose items and cleanliness.
2. Inspect the instrument panel for broken or damaged indicator lights or gauges.
3. Test the horn and other safety devices for proper operation.
4. Inspect the mast and lift chains for wear, broken links, pins and loose rollers.



5. Inspect the carriage, forks or attachments for wear, damage and loose or missing bolts.
6. Inspect the tires and wheels for cuts, gouges, foreign objects, inflation pressure and loose or missing bolts.



7. Inspect the overhead guard for damage and loose or missing mounting bolts.
8. Inspect the hydraulic system for leaks, worn hoses or damaged lines.
9. Look for transmission and drive axle leaks on the truck and on the ground.



10. Inspect the engine compartment for oil, coolant and fuel leaks.

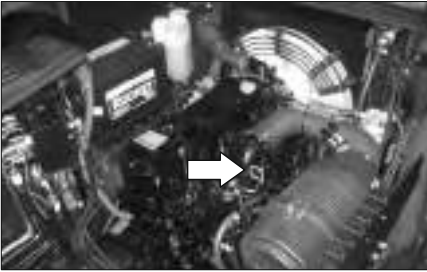

11. Measure the engine crankcase oil level with the dip stick. Maintain the oil level between the MAX. and MIN., (or FULL and ADD) notches on the dip stick.

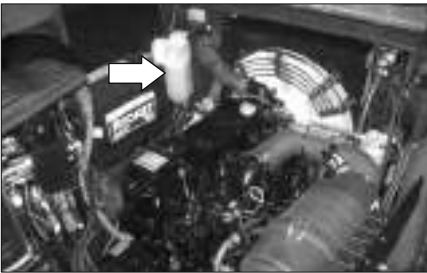

12. Observe the engine coolant level in the coolant recovery bottle. With the engine cold, maintain the level to the COLD mark. If the recovery bottle is empty, also fill the radiator at the top tank.



13. Observe the fuel level gauge after starting the truck. Add fuel if necessary.

⚠ WARNING

Personal injury may occur from accidents caused by improper seat adjustment. Always adjust the operator's seat before starting the lift truck engine.

Seat adjustment must be done at the beginning of each shift and when operators change.



14. To position the seat, PUSH the lever away from the seat track and move the seat forward or backward to a comfortable position.

Starting the Engine

Prestart Conditions

NOTE: The engine will not start unless the transmission directional control lever is in the NEUTRAL position.

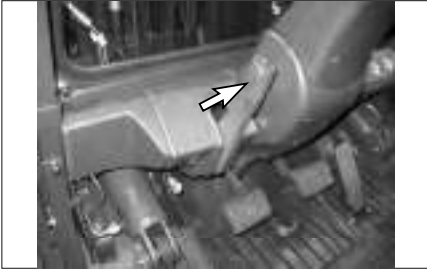

1. Engage the parking brake, if not already engaged. Place the transmission directional control lever in the NEUTRAL position.

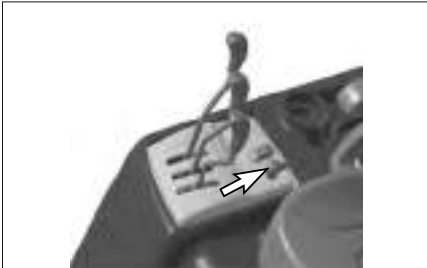

2. Lift trucks equipped with electrical disconnect switches; the engine will not start unless the disconnect switch is in the ON (closed) position.

Gasoline Engine

NOTICE

Do not leave the key in ON position when engine is not running.
Do not engage the starter more than 10 seconds at any one time.

1. Don't press accelerator pedal, and turn the ignition switch to the START position.
2. Once the engine starts, release the ignition switch.
3. If the engine does not start, repeat step 1.
4. If engine coolant is cold, engine speed could be higher than low idle speed. Don't drive forklift until engine speed becomes normal low idle speed.

NOTICE

If the inside of engine cylinder is wet by gasoline, the engine could not start. In this case, press accelerator pedal fully and turn the ignition switch to ON position for 10 seconds. The inside of cylinder would be dry because ECM does not allow gasoline fuel injection. Repeat it three times. Don't press accelerator pedal and turn the Ignition switch to the START position to start engine.

LP Engine

WARNING

LP fuel is flammable and can cause personal injury.

Inspect LP fuel lines and fitting for leaks.

Inspect tank for secure mounting.

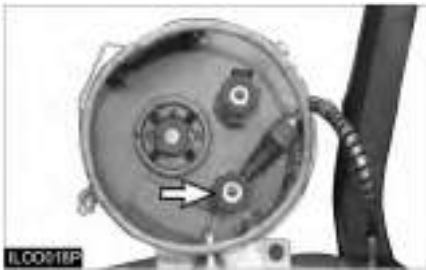

1. Turn the tank fuel valve ON by slowly turning the valve counterclockwise. Observe the LP gauge (if equipped).
2. Don't press accelerator pedal, and turn the ignition switch to the START position.
3. Once the engine starts, release the ignition switch.
4. If the engine does not start, repeat step 2.
5. If engine coolant is cold, engine speed could be higher than normal low idle speed. Don't drive forklift until engine speed becomes normal low idle speed.

Diesel Engine

Starting a Cold Diesel Engine

1. Turn the key to the ON position. The start pre heat light will come ON. The preheat light will stay ON approximately seven seconds, depending on the surrounding air temperature.

NOTICE

Do not engage the starter for more than 10 seconds.

2. When the preheat light goes OFF, turn the key to the START position, with the accelerator pedal pressed.
3. Release the key when the engine starts and release the accelerator pedal to a low idle position.
4. If the engine stalls or does not start, turn the key to the OFF position, then repeat steps 1 thru 3.

Starting a Warm Diesel Engine

1. Turn the key to the ON position and then to START position, without waiting for the preheat light to go OFF. At the same time press the accelerator.
2. Release the key when the engine starts and release the accelerator pedal to a low idle position.

Starting From a 12 Volt External Source

WARNING

Sparks occurring near the battery could cause vapors to explode.

Always connect the external power source ground cable to a point away from and below the battery, and well clear of fuel system components.



NOTICE

Do not reverse battery cables. It can cause damage to the alternator.

Always connect the external power source cables in parallel with the lift truck battery cables : POSITIVE(+) to POSITIVE(+) and NEGATIVE(-) to NEGATIVE(-).

Attach ground cable last, remove first. All lift trucks equipped with DOOSAN built internal combustion engines are NEGATIVE(-) ground.

Dual Fuel System

Changing From Gasoline to LP – Gas



NOTE: The Underwriter's Laboratory (U.L.) requires that the gasoline tank must be at least one - quarter full when operating on LP. This will allow the lift truck to be restarted on gasoline and moved to an approved refueling area, when operating in a hazardous area.

1. Park the lift truck level in an authorized refueling area with the forks lowered, the parking brake applied, the transmission in NEUTRAL and the engine running.

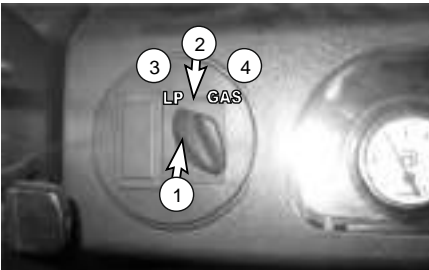

2. Move lever (1), on the fuel selector switch to the OFF (2) position. Leave lever (1) in this position until the engine stops.
3. Move lever (1) to the LPG (3) position.



4. Open the fuel valve, on the LP tank, by slowly turning the valve counterclockwise.
5. Turn the ignition switch key to the OFF position and then to the START position to start the engine. Release it when the engine starts.

Changing From LP to Gasoline

1. Park the lift truck level in an authorized refueling area with the forks lowered, the parking brake applied, the transmission in NEUTRAL and the engine running.

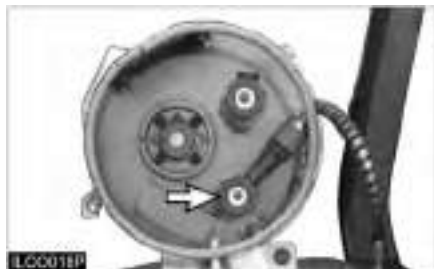

2. Close the fuel valve on the LP tank. hood open.

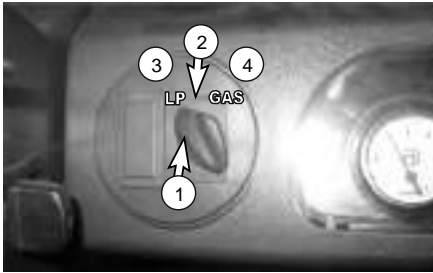

3. Move lever (1) from the LPG (3) POSITION to the OFF (2) position. Allow the engine to run until the fuel in the line runs out and engine stops.
4. Move lever (1) from the LPG (3) position to the GAS (4) position.
5. Turn the ignition switch key to the OFF position.
6. Turn the ignition switch key to the START position and start the engine. Release it when the engine starts.

After Starting the Engine

Observe all indicator lights and gauges frequently during operation, to make sure all systems are working properly. The entire indicator lights will come ON with the ignition switch in the ON position before the engine is started.

Diesel (12V)

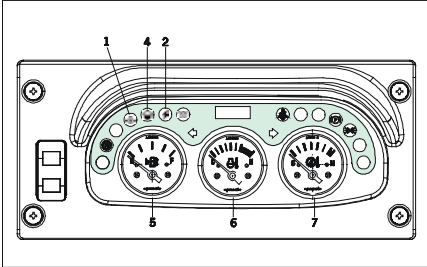

LPG/GAS (12V)

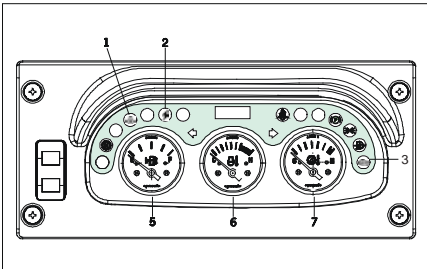

1. The engine oil pressure indicator light (1), will not come ON with the engine running, unless there is low or no oil pressure. Stop the engine immediately, if the light comes ON.
2. The alternator indicator light (2), should not come ON during normal operation. The alternator is not charging if the light comes ON with the engine running.
3. The spark-ignition G420/424F(E) engine MIL(Malfunction Indicator Light)(3) will not come ON with the engine running, unless the fault or faults are stored in the memory of the engine control module(ECM). Stop the engine and check the electric engine control system if the light comes ON. Refer G420F(E)/G424F(E) Engines of this section.

4. The diesel engine water in fuel filter indicator light(4), will not come ON with the engine running, unless water in fuel filter exceeds 100cc. Stop the engine immediately and drain the water if the light comes ON.
5. Observe the fuel level gauge (5) for fuel level in the tank.
6. The engine coolant temperature gauge pointer (6) will be in the green band with the engine running, unless the coolant temperature is excessive.
7. The transmission oil temperature gauge pointer (7) will be in the green band with the engine running, unless the oil temperature is excessive.

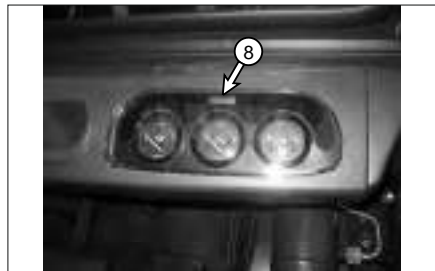

8. Observe the hour meter (8) to make sure it is operating properly.

Lift Truck Operation

Power Shift Transmission/ Drive axle

1. Start the engine. See topic "Starting the Engine".



2. Push down on the service brake pedal to hold the lift truck until ready to move it.
3. Release the parking brake.

NOTE: The parking brake must be released before the directional control can be used.



4. Select the direction of travel by pushing the directional lever FORWARD for forward direction or by pulling the lever BACK for reverse direction.

⚠ WARNING

A lift truck with the engine running but without an operator can move slowly (creep) if the transmission is engaged.

This could result in personal injury.

Always place the transmission control lever in the NEUTRAL (center) position and apply the parking brake before dismantling the lift truck.



5. Release the service brake.
6. Push down on the accelerator pedal to obtain the desired travel speed. Release the pedal to decrease travel speed.

⚠ WARNING

Sudden reversal of a loaded lift truck traveling forward can cause the load to fall or the lift truck to tip over.

Stop the loaded lift truck completely, before shifting to reverse.

Failure to comply could result in personal injury.

NOTE: Where conditions permit, directional changes can be made under full power at speeds up to 6 km/h (3.73 mph). A speed of 6 km/h (3.73 mph) is a fast walk. Directional shift changes at speeds above 6 km/h (3.73 mph) are considered abusive. Bring the lift truck to a complete stop where load stability or other factors prevent safe operation under full power shifts.

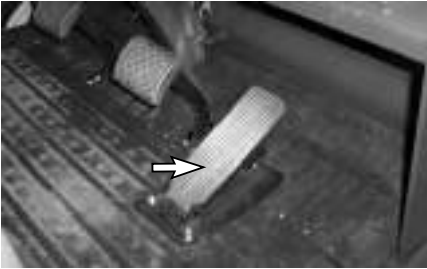

7. To change the lift truck direction of travel, release the accelerator pedal.
8. Push down on the service brake pedal to reduce the lift truck speed as necessary.



9. Move the directional lever to the desired direction of travel. Slowly push down on the accelerator pedal as the lift truck changes direction.
10. When the direction change is completed, continue to push down on the accelerator pedal to obtain the desired travel speed.



11. To stop the lift truck when traveling in either direction, release the accelerator pedal.
12. Push down on the service brake pedal and bring the lift truck to a smooth stop.

Inching



NOTE: The purpose of the inching pedal is to provide precise lift truck inching control at very slow travel speed and high engine rpm. This is used for fast hydraulic lift, during load approach, pick up or load positioning.

1. To inch (creep) in either direction, slowly push down on the inching pedal. This will start to apply the service brakes and allow the transmission clutch discs to slip.
2. Vary the position of the inching pedal and the accelerator pedal to control the inching speed and distance.
3. Pushing down further on the inching pedal will disengage the transmission completely and apply the service brakes fully to stop and hold the lift truck. This will provide full engine power for fast hydraulic lift.

WARNING

Do not use inching pedal instead of brake pedal.

It will give wearing to transmission clutch disc.

Electronic Controlled Spark-Ignition Engines

G420FE Engine and G424FE Engine

EMS (Engine management system) of G420FE engine and G424FE engine is a closed loop system utilizing a 3-way catalytic muffler to reduce the emission level in the exhaust gas. In order to obtain maximum effect from the catalyst, an accurate control of the air fuel ratio is required. A small

engine control module (SECM) uses two heated exhaust gas oxygen sensors (HEGO) in the exhaust system to monitor exhaust gas content. One HEGO is installed in front of the catalytic muffler and one is installed after the catalytic muffler.

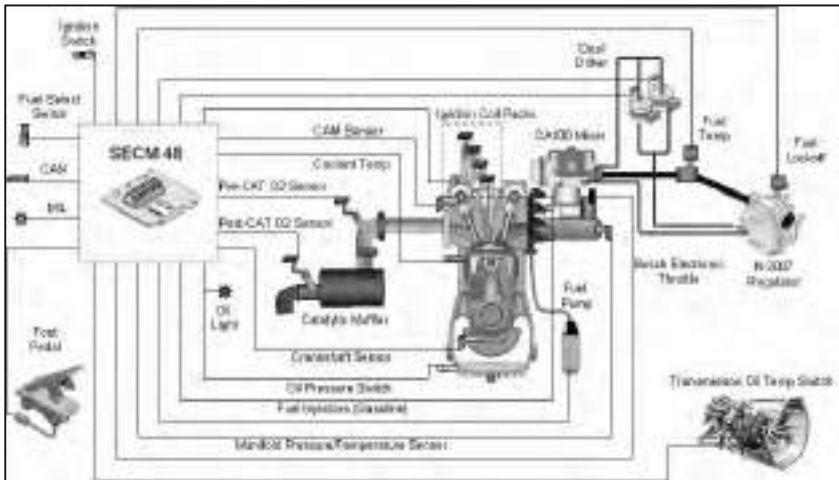

EMS schematic of G420FE Dual fuel engine

The SECM makes any necessary corrections to the air fuel ratio by controlling the inlet fuel pressure to the air/fuel mixer by modulating the dual fuel trim valves (FTV) connected to the regulator. Reducing the fuel pressure leans the air/fuel mixture and increasing the fuel pressure enriches the air/fuel mixture. To calculate any necessary corrections to the air fuel ratio, the SECM uses a number of different sensors to gain information about the engine's performance. Engine speed is monitored by the SECM through a variable reluctance (VR) or Hall Effect sensor. Intake manifold air temperature and absolute pressure are monitored with a TMAP sensor. MI-07 is a drive-by-wire (DBW) system connecting the accelerator pedal to the electronic throttle through the electrical harness; mechanical cables are not used. A throttle position sensor (TPS) monitors throttle position in relation to the accelerator pedal position sensor (APP) command.

Even engine coolant temperature and adequate oil pressure are monitored by the SECM. The SECM controller has full adaptive learning capabilities, allowing it to adapt control function as operating conditions change. Factors such as ambient temperature, fuel variations, ignition component wear, clogged air filter, and other operating variables are compensated.

MPI (multi-point injection) is used for this system. Fuel injection pressure and flow rate depend on engine-specific fuel injection requirements. A variety of regulators and injectors can be used to fit individual needs. The gasoline fuel pressure regulator is a one-way, non-return configuration. All gasoline specific components are automotive production parts and validated to strict automotive standards. Four (4) sequential injection channels are supported.

G420F Engine and G424F Engine

EMS (Engine management system) of G420F engine and G424F engine is an open loop LP system and/or closed loop gasoline system. 3-way catalytic muffler is not used for this system.

LPG regulator and the mixer are operated in open loop as no mixture adjustments are made by the SECM. Manifold pressure from the TMAP, rpm from the crank position sensor and throttle position is used by the SECM to calculate load. Feedback from the electronic throttle is still provided to the SECM by the throttle position sensors (TPS).

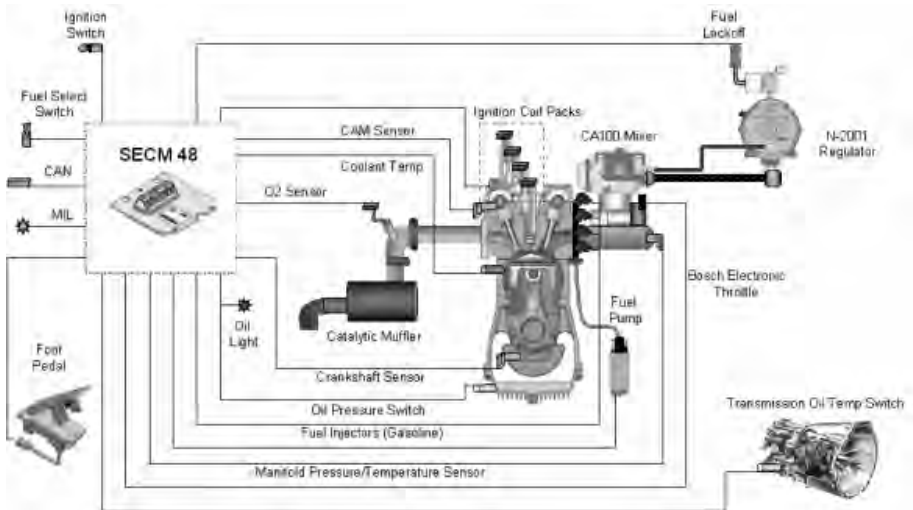

EMS schematic of G420F Dual Fuel engine

Basic Troubleshooting(LP)

The MI-07 systems are equipped with built-in fault diagnostics. Detected system faults can be displayed by the Malfunction Indicator Lamp (MIL) and are covered in the Advanced Diagnostics section. Items such as fuel level, plugged fuel lines, clogged fuel filters and malfunctioning pressure regulators may not set a fault code by the Small Engine Control Module (SECM). Below are

basic checks that should be made before referring to the Advanced Diagnostics section, if engine or drivability problems are encountered.

Locating a problem in a propane engine is done exactly the same way as with a gasoline engine. Consider all parts of the ignition and mechanical systems as well as the fuel system.

Problem	Probable Cause	Corrective Action
Engine Cranking but Will Not Start	Fuel container empty	Fill fuel container <ul style="list-style-type: none"> Do not exceed 80% of liquid capacity
	Liquid valve closed	Slowly open liquid valve
	Excess flow valve closed	Reset excess flow valve <ul style="list-style-type: none"> Close liquid valve Wait for a "click" sound Slowly open liquid valve
	Plugged fuel line	Remove obstruction from the fuel line <ul style="list-style-type: none"> Close liquid fuel valve Using caution, disconnect the fuel line (some propane may escape) Clear obstruction with compressed air Re-connect fuel line Slowly open liquid fuel valve Leak test
	Broken Fuse - SECM	Replace Fuse for SECM <ul style="list-style-type: none"> See Maintenance Section, Fuses replacement
	Clogged fuel filter	Repair/replace as required <ul style="list-style-type: none"> See Maintenance Section, LP Fuel Filter replacement
	Faulty vapor connection between the pressure regulator/converter and the mixer	Check connection <ul style="list-style-type: none"> Verify no holes in hose Clamps must be tight Look for kinked, pinched and/or collapsed hose
	Fuel Lock-off malfunction	Repair/replace Fuel Lock-off <ul style="list-style-type: none"> See Engine Service Manual
	Pressure regulator/converter malfunction	Test pressure regulator/converter operation <ul style="list-style-type: none"> See Engine Service Manual
	Incorrect air/fuel or ignition/spark control	See Advanced Diagnostics
No VR Sensor Signal	Verify the VR signal is present <ul style="list-style-type: none"> See Advanced Diagnostics 	

Problem	Probable Cause	Corrective Action
Difficult to Start	Fuel container almost empty	LPG Vapor from liquid outlet <ul style="list-style-type: none"> • Fill fuel container • Do not exceed 80% of liquid capacity
	Excess flow valve closed	Reset excess flow valve <ul style="list-style-type: none"> • Close liquid valve • Wait for a "click" sound • Slowly open liquid valve
	Clogged fuel filter	Repair/replace as required <ul style="list-style-type: none"> • See <i>Maintenance Section, LP Fuel Filter replacement</i>
	Plugged fuel line	Remove obstruction from the fuel line <ul style="list-style-type: none"> • Close liquid fuel valve • Using caution, disconnect the fuel line (some propane may escape) • Clear obstruction with compressed air • Re-connect fuel line • Slowly open liquid fuel valve • Leak test
	Faulty vapor connection between the pressure regulator/convertor and the mixer	Check connection <ul style="list-style-type: none"> • Verify no holes in hose • Clamps must be tight • Look for kinked, pinched and/or collapsed hose
	Pressure regulator/convertor malfunction	Test pressure regulator/convertor operation <ul style="list-style-type: none"> • See <i>Engine Service Manual</i>
	Fuel container almost empty	LPG Vapor from liquid outlet <ul style="list-style-type: none"> • Fill fuel container • Do not exceed 80% of liquid capacity
	Air filter clogged	Check air filter <ul style="list-style-type: none"> • Clean/replace as required
	Incorrect air/fuel or ignition control	See Advanced Diagnostics
	Engine Mechanical	See Engine Service Manual

Problem	Probable Cause	Corrective Action
Will Not Run Continuously	Fuel container almost empty	LPG Vapor from liquid outlet <ul style="list-style-type: none"> • Fill fuel container • Do not exceed 80% of liquid capacity
	Excess flow valve closed	Reset excess flow valve <ul style="list-style-type: none"> • Close liquid valve • Wait for a "click" sound • Slowly open liquid valve
	Clogged fuel filter	Repair/replace as required <ul style="list-style-type: none"> • See <i>Maintenance Section, LP Fuel Filter replacement</i>
	Plugged fuel line	Remove obstruction from the fuel line <ul style="list-style-type: none"> • Close liquid fuel valve • Using caution, disconnect the fuel line (some propane may escape) • Clear obstruction with compressed air • Re-connect fuel line • Slowly open liquid fuel valve & Leak test
	Pressure regulator freezes	Check level in cooling system <ul style="list-style-type: none"> • Must be full, check coolant strength • -35F minimum Check coolant hoses <ul style="list-style-type: none"> • Watch for kinks and/or pinched hoses • Verify one pressure hose and one return hose
	Fuel Lock-off malfunction	Repair/replace Fuel Lock-off <ul style="list-style-type: none"> • See <i>Engine Service Manual</i>
	Incorrect idle speed or ignition problem	See Advanced Diagnostics
Engine Mechanical	See Engine Service Manual	
Will Not Accelerate/Hesitation During Acceleration	Fuel container almost empty	LPG Vapor from liquid outlet <ul style="list-style-type: none"> • Fill fuel container • Do not exceed 80% of liquid capacity
	Excess flow valve closed	Reset excess flow valve <ul style="list-style-type: none"> • Close liquid valve • Wait for a "click" sound • Slowly open liquid valve

Problem	Probable Cause	Corrective Action
Will Not Accelerate/Hesitation During Acceleration	Clogged fuel filter	Repair/replace as required <ul style="list-style-type: none"> • See <i>Maintenance Section, LP Fuel Filter replacement</i>
	Faulty vapor connection between the pressure regulator/converter and the mixer	Check connection <ul style="list-style-type: none"> • Verify no holes in hose • Clamps must be tight • Look for kinked, pinched and/or collapsed hose
	Throttle butterfly valve not opening or sticking	See Advanced Diagnostics
	Foot Pedal signal incorrect or intermittent	
	Incorrect air/fuel or ignition control Engine Mechanical	See Engine Service Manual
Engine Stalls	Fuel container almost empty	LPG Vapor from liquid outlet <ul style="list-style-type: none"> • Fill fuel container • Do not exceed 80% of liquid capacity
	Excess flow valve closed	Reset excess flow valve <ul style="list-style-type: none"> • Close liquid valve • Wait for a "click" sound • Slowly open liquid valve
	Clogged fuel filter	Repair/replace as required <ul style="list-style-type: none"> • See <i>Maintenance Section, LP Fuel Filter replacement</i>
	Plugged fuel line	Remove obstruction from the fuel line <ul style="list-style-type: none"> • Close liquid fuel valve • Using caution, disconnect the fuel line (some propane may escape) • Clear obstruction with compressed air • Re-connect fuel line • Slowly open liquid fuel valve & Leak test

Problem	Probable Cause	Corrective Action
Engine Stalls	Fuel Lock-off malfunction	Repair/replace Fuel Lock-off <ul style="list-style-type: none"> ● See <i>Engine Service Manual</i>
	Faulty vapor connection between the pressure regulator/converter and the mixer	Check connection <ul style="list-style-type: none"> ● Verify no holes in hose ● Clamps must be tight ● Look for kinked, pinched and/or collapsed hose
	Pressure regulator freezes	Check level in cooling system <ul style="list-style-type: none"> ● Must be full, check coolant strength ● -35F minimum ● Check coolant hoses ● Watch for kinks and/or pinched hoses ● Verify one pressure hose and one return hose
	Pressure regulator malfunction	Test pressure regulator operation <ul style="list-style-type: none"> ● See <i>Engine Service Manual</i>
	Vacuum leak	Check for vacuum leaks <ul style="list-style-type: none"> ● Between mixer and throttle body ● Between throttle body and intake manifold ● Between intake manifold and cylinder head
	Air/Fuel Mixer malfunction	Check mixer <ul style="list-style-type: none"> ● See <i>Engine Service Manual</i>
Engine Mechanical	See Engine Manufacturers Service Manual	
Rough Idle	Faulty vapor connection between the pressure regulator/converter and the mixer	Check connection <ul style="list-style-type: none"> ● Verify no holes in hose ● Clamps must be tight ● Look for kinked, pinched and/or collapsed hose
	Pressure regulator malfunction	Test pressure regulator operation <ul style="list-style-type: none"> ● See <i>Engine Service Manual</i>
	Vacuum leak	Check for vacuum leaks <ul style="list-style-type: none"> ● Between mixer and throttle body ● Between throttle body and intake manifold ● Between intake manifold and cylinder head
	Air/Fuel Mixer malfunction	Check mixer <ul style="list-style-type: none"> ● See <i>Engine Service Manual</i>

Problem	Probable Cause	Corrective Action
Rough Idle	Incorrect Idle speed control	See Advanced Diagnostics & See Engine Service Manual
	Incorrect timing or spark control	
	Engine Mechanical	See Engine Service Manual
High Idle Speed	Incorrect Idle speed control	See Advanced Diagnostics & See Engine Service Manual
	Throttle sticking	
	Foot pedal sticking or incorrect pedal signal	Check pedal return spring travel for binding <ul style="list-style-type: none"> • See <i>Advanced Diagnostics</i>
Poor High Speed Performance	Clogged fuel filter	Repair/replace as required <ul style="list-style-type: none"> • See <i>Maintenance section, Fuel Filter replacement</i>
	Plugged fuel line	Remove obstruction from the fuel line <ul style="list-style-type: none"> • Close liquid fuel valve • Using caution, disconnect the fuel line (some propane may escape) • Clear obstruction with compressed air • Re-connect fuel line • Slowly open liquid fuel valve & Leak test
	Air filter clogged	Check air filter <ul style="list-style-type: none"> • Clean/replace as required
	Faulty vapor connection between the pressure regulator/convertor and the mixer	Check connection <ul style="list-style-type: none"> • Verify no holes in hose • Clamps must be tight • Look for kinked, pinched and/or collapsed hose
	Pressure regulator malfunction	Test pressure regulator operation <ul style="list-style-type: none"> • See <i>Engine Service Manual</i>
	Air/Fuel Mixer malfunction	Check mixer <ul style="list-style-type: none"> • See <i>Engine Service Manual</i>
	Restricted exhaust system	Check exhaust system <ul style="list-style-type: none"> • Measure exhaust back pressure
	Incorrect ignition control	
	Incorrect air/fuel control	See Advanced Diagnostics & See Engine Service Manual
	Incorrect throttle position	

Problem	Probable Cause	Corrective Action
Excessive Fuel Consumption/LPG Exhaust Smell	Air/Fuel Mixer malfunction	Check mixer <ul style="list-style-type: none"> • See <i>Engine Service Manual</i>
	Air filter clogged	Check air filter <ul style="list-style-type: none"> • Clean/replace as required
	Vacuum leak	Check system vacuum hoses from regulator to FTV and mixer <ul style="list-style-type: none"> • Repair/replace as necessary
	Pressure regulator malfunction/fuel pressure too high	Test pressure regulator operation <ul style="list-style-type: none"> • See <i>Engine Service Manual</i>
	Faulty FTV	Check FTV for housing cracks or obstructions <ul style="list-style-type: none"> • See <i>Advanced Diagnostics FTV operation</i> • Repair and/or replace as necessary
	Weak ignition and/or spark control	See <i>Advanced Diagnostics</i>
	Incorrect air/fuel control	See <i>Advanced Diagnostics</i>
	Exhaust system leaks	Repair exhaust system
	Oxygen sensor failure	Replace as necessary <ul style="list-style-type: none"> • See <i>Advanced Diagnostics</i>

Basic Troubleshooting (Gasoline)

Problem	Probable Cause	Corrective Action
Engine Cranking but Will Not Start (Gas)	Fuel tank empty	Fill fuel container <ul style="list-style-type: none"> The tank should be at least ¼ full to properly prime the fuel pump. Fuel select switch is not on GAS
	Clogged fuel filter	Repair/replace as required <ul style="list-style-type: none"> See <i>Maintenance section Primary and Secondary Fuel Filter replacement</i>
	Faulty vapor connection between the pressure regulator/ converter and the mixer (LPG)	Check connection <ul style="list-style-type: none"> Verify no holes in hose Clamps must be tight Look for kinked, pinched and/or collapsed hose
	Electric Fuel Pump malfunction (GAS)	Check electrical connection <ul style="list-style-type: none"> Check Relay and fuse Turn key ON and verify pump is operating
	Fuel Pressure regulator malfunction	Test pressure regulator operation <ul style="list-style-type: none"> See <i>Engine Service Manual</i>
	Fuel Injector malfunction	Test Injector operation <ul style="list-style-type: none"> See <i>Engine Service Manual</i>
	Incorrect air/fuel or ignition/ spark control	See Advanced Diagnostics
	No VR Sensor Signal	Verify the VR signal is present <ul style="list-style-type: none"> See <i>Advanced Diagnostics</i>

Problem	Probable Cause	Corrective Action
Difficult to Start (Gas)	Fuel tank almost empty	Fuel Pump Cavitations <ul style="list-style-type: none"> • The tank should be at least ¼ full to properly prime the fuel pump • Fuel select switch is not on GAS
	Clogged fuel filter	Repair/replace as required <ul style="list-style-type: none"> • See <i>Maintenance section, Primary and Secondary Fuel Filter replacement</i>
	Electric Fuel Pump malfunction (GAS)	Check electrical connection <ul style="list-style-type: none"> • Check Relay and fuse Turn key ON and verify pump is operating • See <i>Engine Service Manual</i>
	Pressure regulator malfunction	Test pressure regulator operation <ul style="list-style-type: none"> • See <i>Engine Service Manual</i>
	Fuel Injector malfunction	Test Injector operation <ul style="list-style-type: none"> • See <i>Engine Service Manual</i>
	Air filter clogged	Check air filter <ul style="list-style-type: none"> • Clean/replace as required
	Incorrect air/fuel or ignition control Engine Mechanical	See <i>Advanced Diagnostics</i> See <i>Engine Service Manual</i>
Will Not Run Continuously (Gas)	Isolate the gasoline system by running the lift truck on LPG	Verify LPG cylinder is full and valve is open. If the problem does not exist in LPG mode proceed with the corrective action steps below. If the problem also exists in LPG mode then the root cause is most likely to be something other than the fuel system <ul style="list-style-type: none"> • See <i>Advanced Diagnostics</i>
	Fuel tank almost empty	Fuel Pump Cavitations <ul style="list-style-type: none"> • The tank should be at least ¼ full to properly prime the fuel pump
	Clogged fuel filter	Repair/replace as required <ul style="list-style-type: none"> • See <i>Maintenance section, Primary and Secondary Fuel Filter replacement</i>

Problem	Probable Cause	Corrective Action
Will Not Run Continuously (Gas)	Electric Fuel Pump malfunction (GAS)	Check electrical connection <ul style="list-style-type: none"> • Check Relay and fuse Turn key ON and verify pump is operating • See <i>Engine Service Manual</i>
	Pressure regulator malfunction	Test pressure regulator operation <ul style="list-style-type: none"> • See <i>Engine Service Manual</i>
	Fuel Injector malfunction	Test Injector operation <ul style="list-style-type: none"> • See <i>Engine Service Manual</i>
	Incorrect idle speed or ignition problem	See Advanced Diagnostics
	Engine Mechanical	See Engine Service Manual
Will Not Accelerate/Hesitation During Acceleration or Engine Stalls (Gas)	Isolate the gasoline system by running the lift truck on LPG	Verify LPG cylinder is full and valve is open. If the problem does not exist in LPG mode proceed with the corrective action steps below. If the problem also exists in LPG mode then the root cause is most likely to be something other than the fuel system <ul style="list-style-type: none"> • See <i>Advanced Diagnostics</i>
	Fuel tank almost empty	Fuel Pump Cavitations <ul style="list-style-type: none"> • The tank should be at least ¼ full to properly prime the fuel pump
	Clogged fuel filter	Repair/replace as required <ul style="list-style-type: none"> • See <i>Maintenance section, Primary and Secondary Fuel Filter replacement</i>
	Pressure regulator malfunction	Test pressure regulator operation <ul style="list-style-type: none"> • See <i>Engine Service Manual</i>
	Fuel Injector malfunction	Test injector operation

Problem	Probable Cause	Corrective Action
Will Not Accelerate/Hesitation During Acceleration or Engine Stalls (Gas)	Throttle butterfly valve not opening or sticking	See Advanced Diagnostics
	Foot Pedal signal incorrect or intermittent	
	Incorrect air/fuel or ignition control	
	Engine Mechanical	See Engine Service Manual
Rough Idle (Gas)	Isolate the gasoline system by running the lift truck on LPG	Verify LPG cylinder is full and valve is open. If the problem does not exist in LPG mode proceed with the corrective action steps below. If the problem also exists in LPG mode then the root cause is most likely to be something other than the fuel system <ul style="list-style-type: none"> • See <i>Advanced Diagnostics & Service Manual</i>
	Pressure regulator malfunction	Test pressure regulator operation <ul style="list-style-type: none"> • See <i>Engine Service Manual</i>
	Clogged fuel filter	Repair/replace as required <ul style="list-style-type: none"> • See <i>Maintenance section, Primary and Secondary Fuel Filter replacement</i>
	Pressure regulator malfunction	Test pressure regulator operation <ul style="list-style-type: none"> • See <i>Engine Service Manual</i>
	Fuel Injector malfunction	Test Injector operation <ul style="list-style-type: none"> • See <i>Engine Service Manual</i>
	Vacuum leak	Check for vacuum leaks <ul style="list-style-type: none"> • Between mixer and throttle body • Between throttle body and intake manifold • Between intake manifold and cylinder head

Problem	Probable Cause	Corrective Action
Rough Idle (Gas)	Incorrect Idle speed control	See Advanced Diagnostics & Engine Service Manual
	Incorrect timing or spark control	
	Engine Mechanical	See Engine Service Manual
High Idle Speed (Gas)	Incorrect Idle speed control	See Advanced Diagnostics & Engine Service Manual
	Throttle sticking	
	Foot pedal sticking or incorrect pedal signal	Check pedal return spring travel for binding See Advanced Diagnostics

Problem	Probable Cause	Corrective Action
Poor High Speed Performance (Gas)	Isolate the gasoline system by running the lift truck on LPG	Verify LPG cylinder is full and valve is open. If the problem does not exist in LPG mode proceed with the corrective action steps below. If the problem also exists in LPG mode then the root cause is most likely to be something other than the fuel system See Advanced Diagnostics & Dual Fuel Engine Service Manual
	Clogged fuel filter	Repair/replace as required • See <i>Maintenance section, Fuel Filter replacement</i>
	Plugged fuel line	Remove obstruction from the fuel line • Close liquid fuel valve • Using caution, disconnect the fuel line (some propane may escape) • Clear obstruction with compressed air • Re-connect fuel line • Slowly open liquid fuel valve & Leak test
	Air filter clogged	Check air filter • Clean/replace as required
	Faulty vapor connection between the pressure regulator/convertor and the mixer	Check connection • Verify no holes in hose • Clamps must be tight • Look for kinked, pinched and/or collapsed hose
	Pressure regulator malfunction	Test pressure regulator operation • See Dual Fuel Engine Service Manual

Problem	Probable Cause	Corrective Action
Poor High Speed Performance (Gas)	Air/Fuel Mixer malfunction	Check mixer • See <i>Engine Service Manual</i>
	Restricted exhaust system	Check exhaust system • <i>Measure exhaust back pressure</i>
	Incorrect ignition control	See Advanced Diagnostics & Engine Service Manual
	Incorrect air/fuel control	
	Incorrect throttle position	

Advanced Diagnostics

MI-07 systems are equipped with built-in fault diagnostics. Detected system faults can be displayed by the Malfunction Indicator Lamp (MIL) as Diagnostic Fault Codes (DFC) or flash codes, and viewed in detail with the use of the Service Tool software. When the ignition key is turned on, the MIL will illuminate and remain on until the engine is started. Once the engine is started, the MIL lamp will go out unless one or more fault conditions are present. If a detected fault condition exists, the fault or faults will be stored in the memory of the small engine control module (SECM). Once an active fault occurs the MIL will illuminate and remain ON. This signals the operator that a fault has been detected by the SECM.

Reading Diagnostic Fault Codes

All MI-07 fault codes are three-digit codes. When the fault codes are retrieved (displayed) the MIL will flash for each digit with a short pause (0.5 seconds) between digits and a long pause (1.2 seconds) between fault codes. A code 12 is displayed at the end of the code list.

EXAMPLE: A code 461 (ETCSticking) has been detected and the engine has shut down and the MIL has remained ON. When the codes are displayed the MIL will flash four times (4), pause, then flash six times (6), pause, then flash one time (1) This identifies a four sixty one (461), which is the ETCSticking fault. If any additional faults were stored, the SECM would again have a long pause, then display the next fault by flashing each digit. Since no other faults were stored there will be a long pause then one flash (1), pause, then two flashes (2). This identifies a twelve, signifying the end of the fault list. This list will then repeat.

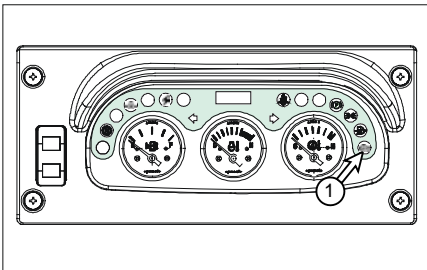

(1) Malfunction Indicator Lamp (MIL) for Engine control system.

Displaying Fault Codes (DFC) from SECM Memory

To enter code display mode you must turn OFF the ignition key. Now turn ON the key but do not start the engine. As soon as you turn the key to the ON position you must cycle the foot pedal by depressing it to the floor and then fully releasing the pedal (pedal maneuver). You must fully cycle the foot pedal three (3) times within five (5) seconds to enable the display codes feature of the SECM. Simply turn the key OFF to exit display mode. The code list will continue to repeat until the key is turned OFF.

Table 2. MI-07 Diagnostic Fault Codes (Flash Codes)

DFC	PROBABLE FAULT	FAULT ACTION *	CORRECTIVE ACTION FIRST CHECK
12	NONE Signifies the end of one pass through the fault list	NONE	None, used as end of the fault list identification
131	Inj1Open Gasoline Injector 1 open circuit, broken injector 1 wire or defective injector	(1) TurnOnMil (2) Disable LiquidO2Ctrl (3) Delayed EngineShutdown	Check INJ1 wiring for an open circuit SECM (Signal) A5 to Injector 1 Pin A Switched 12V to Injector 1 Pin B Check Injector 1 Resistance, 12 to14 ohms (cold)
132	Inj2Open Gasoline Injector 2 open circuit, broken injector 2 wire or defective injector	(1) TurnOnMil (2) Disable LiquidO2Ctrl (3) Delayed EngineShutdown	Check INJ2 wiring for an open circuit SECM (Signal) A8 to Injector 2 Pin A Switched 12V to Injector 2 Pin B Check Injector 2 Resistance, 12 to14 ohms (cold)
133	Inj3Open Gasoline Injector 3 open circuit, broken injector 3 wire or defective injector	(1) TurnOnMil (2) Disable LiquidO2Ctrl (3) Delayed EngineShutdown	Check INJ3 wiring for an open circuit SECM (Signal) A4 to Injector 3 Pin A Switched 12V to Injector 3 Pin B Check Injector 3 Resistance, 12 to14 ohms (cold)
134	Inj4Open Gasoline Injector 4 open circuit, broken injector 4 wire or defective injector	(1) TurnOnMil (2) Disable LiquidO2Ctrl (3) Delayed EngineShutdown	Check INJ4 wiring for an open circuit SECM (Signal) A7 to Injector 4 Pin A Switched 12V to Injector 4 Pin B Check Injector 4 Resistance, 12 to 14 ohms (cold)
141 (14)	ECTRangeLow Coolant Sensor failure or shorted to GND	(1) TurnOnMil (2) DelayedEngine Shutdown	Check ECT sensor connector and wiring for a short to GND SECM (Signal) Pin B15 To ECT Pin 3 SECM (Sensor GND) Pin B1 to ECT Pin 1 SECM (System GND) Pin A16, B17
151 (15)	ECTRangeHigh Coolant sensor disconnected or open circuit	(1) TurnOnMil (2) DelayedEngine Shutdown	Check if ECT sensor connector is disconnected or for an open ECT circuit SECM (Signal) Pin B15 to ECT Pin 3 SECM (Sensor GND) Pin B1 to ECT Pin 1

(*) Fault actions shown are default values specified by the OEM.

Table 2. MI-07 Diagnostic Fault Codes (Flash Codes) cont'd.

DFC	PROBABLE FAULT	FAULT ACTION *	CORRECTIVE ACTION FIRST CHECK
161 (16)	ECTOverTempFault Engine coolant temperature is high. The sensor has measured an excessive coolant temperature typically due to the engine overheating.	(1) TurnOnMil (2) DelayedEngine Shutdown	Check coolant system for radiator blockage, proper coolant level and for leaks in the system. Possible ECT short to GND, check ECT signal wiring SECM (Signal) Pin B15 to ECT Pin 3 SECM (Sensor GND) Pin B1 to ECT Pin 1 SECM (System GND) Pin A16, B17 Check regulator for coolant leaks
171	ECT_IR_Fault Engine coolant temperature not changing as expected	TurnOnMil	Check for coolant system problems, e.g. defective or stuck thermostat
181	FuelSelectConflict Conflict in fuel select signals, normally set if both of the fuel select signals are shorted to ground	(1) TurnOnMil (2) Delayed EngineShutdown	Check fuel select switch connection for a short to GND SECM (SIGNAL) Pin A12 SECM (SIGNAL) Pin A15 SECM (Sensor GND) Pin B1
191	CamEdgesFault No CAM signal when engine is known to be rotating, broken crankshaft sensor leads or defective CAM sensor	None	Check CAM sensor connections SECM (SIGNAL) Pin B10 to CAM sensor Pin 2 SECM (Sensor GND) Pin B1 to CAM sensor Pin 3 Switched 12V to CAM sensor Pin 1 Check for defective CAM sensor
192	CamSyncFault Loss of synchronization on the CAM sensor, normally due to noise on the signal or an intermittent connection on the CAM sensor	None	Check CAM sensor connections SECM (SIGNAL) Pin B10 to CAM sensor Pin 2 SECM (Sensor GND) Pin B1 to CAM sensor Pin 3 Switched 12V to CAM sensor Pin 1 Check for defective CAM sensor
193	CrankEdgesFault No crankshaft signal when engine is known to be rotating, broken crankshaft sensor leads or defective crank sensor	None	Check Crankshaft sensor connections SECM (SIGNAL) Pin B5 to Crank sensor Pin 3 SECM (Sensor GND) PIN B1 to Crank sensor Pin 2 Switched 12V to Crank sensor Pin 1 Check for defective Crank sensor
194	CrankSyncFault Loss of synchronization on the crankshaft sensor, normally due to noise on the signal or an intermittent connection on the crankshaft sensor	None	Check Crankshaft sensor connections SECM (SIGNAL) Pin B5 to Crank sensor Pin 3 SECM (Sensor GND) Pin B1 to Crank sensor Pin 2 Switched 12V to Crank sensor Pin 1 Check for defective Crank sensor

(*) Fault actions shown are default values specified by the OEM.

Table 2. MI-07 Diagnostic Fault Codes (Flash Codes) cont'd.

DFC	PROBABLE FAULT	FAULT ACTION *	CORRECTIVE ACTION FIRST CHECK
221 (22)	TPS1RangeLow TPS1 sensor voltage out of range low, normally set if the TPS1 signal has shorted to ground, circuit has opened or sensor has failed	(1) TurnOnMil (2) CutThrottle	Check throttle connector connection and TPS1 sensor for an open circuit or short to GND SECM Pin B23 (signal) to ETC Pin 6 SECM Pin B1 (sensor GND) to ETC Pin 2 SECM (system GND) Pin A16, B17
222	TPS2RangeLow TPS2 sensor voltage out of range low, normally set if the TPS2 signal has shorted to ground, circuit has opened or sensor has failed	(1) TurnOnMil (2) CutThrottle	Check throttle connector connection and TPS2 sensor for an open circuit or short to GND SECM Pin B4 (signal) to ETC Pin 5 SECM Pin B1 (sensor GND) to ETC Pin 2 SECM (system GND) Pin A16, B17
231 (23)	TPS1RangeHigh TPS1 sensor voltage out of range high, normally set if the TPS1 signal has shorted to power or the ground for the sensor has opened	(1) TurnOnMil (2) CutThrottle	Check throttle connector and TPS1 sensor wiring for a shorted circuit SECM Pin B23 (signal) to ETC Pin 6 SECM Pin B1 (sensor GND) to ETC Pin 2
232	TPS2RangeHigh TPS2 sensor voltage out of range high, normally set if the TPS2 signal has shorted to power or the ground for the sensor has opened	(1) TurnOnMil (2) CutThrottle	Check throttle connector and TPS1 sensor wiring for a shorted circuit SECM Pin B4 (signal) to ETC Pin 5 SECM pin B1 (sensor GND) to ETC Pin 2
241 (24)	TPS1AdaptLoMin Learned closed throttle end of TPS1 sensor range lower than expected	None	N/A
242	TPS2AdaptLoMin Learned closed throttle end of TPS2 sensor range lower than expected	None	N/A
251 (25)	TPS1AdaptHiMax Learned WOT end of TPS1 sensor range higher than expected	None	N/A
252	TPS2AdaptHiMax Learned WOT end of TPS2 sensor range higher than expected	None	N/A
271	TPS1AdaptHiMin Learned WOT end of TPS1 sensor range lower than expected	None	N/A

(*) Fault actions shown are default values specified by the OEM.

Table 2. Diagnostic Fault Codes (Flash Codes) cont'd.

DFC	PROBABLE FAULT	FAULT ACTION *	CORRECTIVE ACTION FIRST CHECK
272	TPS2AdaptHiMin Learned WOT end of TPS2 sensor range lower than expected	None	N/A
281	TPS1AdaptLoMax Learned closed throttle end of TPS1 sensor range higher than expected	None	N/A
282	TPS2AdaptLoMax Learned closed throttle end of TPS2 sensor range higher than expected	None	N/A
291	TPS_Sensors_Conflict TPS sensors differ by more than expected amount NOTE: The TPS is not a serviceable item and can only be repaired by replacing the DV-EV throttle assembly.	(1) TurnOnMil (2) CutThrottle	Check the throttle connector and pins for corrosion. To check the TPS disconnect the throttle connector and measure the resistance from: TPS Pin 2 (GND) to Pin 6 (TPS1 SIGNAL) (0.7 Ω \pm 30%) TPS Pin 3 (PWR) to Pin 6 (TPS1 SIGNAL) (1.4 Ω \pm 30%)
331 (33)	MAPTimeRangeLow Manifold Absolute Pressure sensor input is low, normally set if the TMAP pressure signal wire has been disconnected or shorted to ground or the circuit has opened to the SECM	TurnOnMil	Check TMAP connector and MAP signal wiring for an open circuit TMAP Pin 4 to SECM Pin B18 (signal) TMAP Pin 1 to SECM Pin B1 (sensor GND) TMAP Pin 3 to SECM Pin B24 (XDRP +5 Vdc) Check the MAP sensor by disconnecting the TMAP connector and measuring at the sensor: TMAP Pin 1 (GND) to Pin 4 (pressure signal KPA) (2.4k Ω - 8.2k Ω) TMAP Pin 3 (power) to Pin 4 (pressure signal KPA) (3.4k Ω - 8.2k Ω)
332	MAPRangeLow Manifold Absolute Pressure sensor input is low, normally set if the TMAP pressure signal wire has been disconnected or shorted to ground or the circuit has opened to the SECM	(1) TurnOnMil (2) EngineShutdown	Check TMAP connector and MAP signal wiring for an open circuit TMAP Pin 4 to SECM Pin B18 (signal) TMAP Pin 1 to SECM Pin B1 (sensor GND) TMAP Pin 3 to SECM Pin B24 (XDRP +5 Vdc) Check the MAP sensor by disconnecting the TMAP connector and measuring at the sensor: TMAP Pin 1 (GND) to Pin 4 (pressure signal KPA) (2.4k Ω - 8.2k Ω) TMAP Pin 3 (power) to Pin 4 (pressure signal KPA) (3.4k Ω - 8.2k Ω)

(*) Fault actions shown are default values specified by the OEM.

Table 2. Diagnostic Fault Codes (Flash Codes) cont'd.

DFC	PROBABLE FAULT	FAULT ACTION *	CORRECTIVE ACTION FIRST CHECK
341 (34)	MAPTimeRangeHigh Manifold Absolute Pressure Sensor Input is High, normally set if the TMAP pressure signal wire has become shorted to power, shorted to the IAT signal, the TMAP has failed or the SECM has failed.	TurnOnMil	Check TMAP connector and MAP signal wiring for a shorted circuit TMAP Pin 4 to SECM Pin B18 (signal) TMAP Pin 1 to SECM Pin B1 (sensor GND) TMAP Pin 3 to SECM Pin B24 (XDRP +5 Vdc) Check the MAP sensor by disconnecting the TMAP connector and measuring at the sensor: TMAP Pin 1(GND) to Pin 4 (pressure signal KPA) (2.4kΩ - 8.2kΩ) TMAP Pin 3 (power) to Pin 4 (pressure signal KPA) (3.4kΩ - 8.2kΩ)
342	MAPRangeHigh Manifold Absolute Pressure Sensor Input is High, normally set if the TMAP pressure signal wire has become shorted to power, shorted to the IAT signal, the TMAP has failed or the SECM has failed	(1) TurnOnMil (2) Engine Shutdown	Check TMAP connector and MAP signal wiring for a shorted circuit TMAP Pin 4 to SECM Pin B18 (signal) TMAP Pin 1 to SECM Pin B1 (sensor GND) TMAP Pin 3 to SECM Pin B24 (XDRP +5 Vdc) Check the MAP sensor by disconnecting the TMAP connector and measuring at the sensor: TMAP Pin 1(GND) to Pin 4 (pressure signal KPA) (2.4kΩ - 8.2kΩ) TMAP Pin 3 (power) to Pin 4 (pressure signal KPA) (3.4kΩ - 8.2kΩ)
351	MAP_IR_HI MAP sensor indicates higher pressure than expected	TurnOnMil	Check for vacuum leaks. Check that TMAP sensor is mounted properly. Possible defective TMAP sensor.
352	MAP_IR_LO MAP sensor indicates lower pressure than expected	TurnOnMil	Possible defective TMAP sensor.
353	MAP_STICKING MAP sensor not changing as expected	TurnOnMil	Check that TMAP sensor is mounted properly. Possible defective TMAP sensor.
371 (37)	IATRangeLow Intake Air Temperature Sensor Input is Low normally set if the IAT temperature sensor wire has shorted to chassis ground or the sensor has failed.	TurnOnMil	Check TMAP connector and IAT signal wiring for a shorted circuit TMAP Pin 2 to SECM Pin B12 (signal) TMAP Pin 1 to SECM Pin B1 (sensor GND) To check the IAT sensor of the TMAP disconnect the TMAP connector and measure the IAT resistance Resistance is approx 2400 ohms at room temperature.

(*) Fault actions shown are default values specified by the OEM.

Table 2. Diagnostic Fault Codes (Flash Codes) cont'd.

DFC	PROBABLE FAULT	FAULT ACTION *	CORRECTIVE ACTION FIRST CHECK
381 (38)	IATRangeHigh Intake Air Temperature Sensor Input is High normally set if the IAT temperature sensor wire has been disconnected or the circuit has opened to the SECM.	TurnOnMil	Check TMAP connector and IAT signal wiring for a shorted circuit TMAP Pin 2 to SECM Pin B12 (signal) TMAP Pin 1 to SECM Pin B1 (sensor GND) To check the IAT sensor of the TMAP disconnect the TMAP connector and measure the IAT resistance Resistance is approx 2400 ohms at room temperature.
391	IAT_IR_Fault Intake Air Temperature not changing as expected	None	Check connections to TMAP sensor. Check that TMAP sensor is properly mounted to manifold.
421	EST1_Open EST1 output open, possibly open EST1 signal or defective spark module	TurnOnMil	Check coil driver wiring and connector for open circuit SECM Pin A9 (EST1) to OEM ignition system. See application note. Verify GND on ignition module Pin A (of both connectors) Verify +12 Vdc on ignition module Pin B (of both connectors) Refer to application manual for specific engine details.
422	EST2_Open EST2 output open, possibly open EST2 signal or defective spark module	TurnOnMil	Check coil driver wiring and connector for open circuit SECM Pin A10 (EST2) to OEM ignition system. See application note. Verify GND on ignition module Pin A (of both connectors) Verify +12 Vdc on ignition module Pin B (of both connectors) Refer to application manual for specific engine details.
423	EST3_Open EST3 output open, possibly open EST3 signal or defective spark module	TurnOnMil	Check coil driver wiring and connector for open circuit SECM Pin A3 (EST3) to OEM ignition system. See application note. Verify GND on ignition module Pin A (of both connectors) Verify +12 Vdc on ignition module Pin B (of both connectors) Refer to application manual for specific engine details.

(*) Fault actions shown are default values specified by the OEM.

Table 2. Diagnostic Fault Codes (Flash Codes) cont'd.

DFC	PROBABLE FAULT	FAULT ACTION *	CORRECTIVE ACTION FIRST CHECK
424	EST4_Open EST4 output open, possibly open EST4 signal or defective spark module	TurnOnMil	Check coil driver wiring and connector for open circuit SECM Pin A6 (EST4) to OEM ignition system. See application manual. Verify GND on ignition module Pin A (of both connectors) Verify +12 Vdc on ignition module Pin B (of both connectors) Refer to application manual for specific engine details.
425	EST5_Open EST5 output open, possibly open EST5 signal or defective spark module	None	N/A
426	EST6_Open EST6 output open, possibly open EST6 signal or defective spark module	None	N/A
427	EST7_Open EST7 output open, possibly open EST7 signal or defective spark module	None	N/A
428	EST8_Open EST8 output open, possibly open EST8 signal or defective spark module	None	N/A
431	EST1_Short EST1 output shorted high or low, EST1 signal shorted to ground or power or defective spark module	None	N/A

(*) Fault actions shown are default values specified by the OEM.

Table 2. Diagnostic Fault Codes (Flash Codes) cont'd.

DFC	PROBABLE FAULT	FAULT ACTION *	CORRECTIVE ACTION FIRST CHECK
432	EST2_Short EST2 output shorted high or low, EST2 signal shorted to ground or power or defective spark module	None	N/A
433	EST3_Short EST3 output shorted high or low, EST3 signal shorted to ground or power or defective spark module	None	N/A
434	EST4_Short EST4 output shorted high or low, EST4 signal shorted to ground or power or defective spark module	None	N/A
435	EST5_Short EST5 output shorted high or low, EST5 signal shorted to ground or power or defective spark module	None	N/A
436	EST6_Short EST6 output shorted high or low, EST6 signal shorted to ground or power or defective spark module	None	N/A

(*) Fault actions shown are default values specified by the OEM.

Table 2. Diagnostic Fault Codes (Flash Codes) cont'd.

DFC	PROBABLE FAULT	FAULT ACTION *	CORRECTIVE ACTION FIRST CHECK
437	EST7_Short EST7 output shorted high or low, EST7 signal shorted to ground or power or defective spark module	None	N/A
438	EST8_Short EST8 output shorted high or low, EST8 signal shorted to ground or power or defective spark module	None	N/A
461 (26)	ETC_Sticking Electronic Throttle Control is sticking. This can occur if the throttle plate (butterfly valve) inside the throttle bore is sticking. The plate sticking can be due to some type of obstruction, a loose throttle plate, or worn components shaft bearings. NOTE: The throttle assembly is not a serviceable item and can only be repaired by replacing the DV-EV throttle assembly.	(1) TurnOnMil (2) EngineShutdown (3) CutThrottle	Check for debris or obstructions inside the throttle body Perform the throttle test using the Service Tool and re-check for fault <ul style="list-style-type: none"> • Check throttle-plate shaft for bearing wear • Check the ETC driver wiring for an open circuit SECM Pin A17 to ETC + Pin 1 SECM Pin A18 to ETC - Pin 4 Check the ETC internal motor drive by disconnecting the throttle connector and measuring the motor drive resistance at the throttle TPS Pin 1 (+DRIVER) to Pin 4 (-DRIVER) ~3.0-4.0Ω
471	ETC_Open_Fault Electronic Throttle Control Driver has failed, normally set if driver signals have failed open or become disconnected, electronic throttle or SECM is defective.	(1) TurnOnMil (2) CutThrottle	Check the ETC driver wiring for an open circuit SECM Pin A17 to ETC + Pin 1 SECM Pin A18 to ETC - Pin 4 Check the ETC internal motor drive by disconnecting the throttle connector and measuring the motor drive resistance at the throttle TPS Pin 1 (+DRIVER) to Pin 4 (-DRIVER) ~3.0-4.0Ω
481 (28)	ETCSpringTest Electronic Throttle Control Spring Return Test has failed. The SECM will perform a safety test of the throttle return spring following engine shutdown. If the drive mechanism is damaged, or the return spring has lost tension the throttle will fail the test and set the fault. NOTE: The throttle assembly is not a serviceable item and can only be repaired by replacing the DV-EV throttle assembly.	(1) TurnOnMil (2) EngineShutdown (3) CutThrottle	Perform throttle spring test by cycling the ignition key and re-check for fault

(*) Fault actions shown are default values specified by the OEM.

Table 2. Diagnostic Fault Codes (Flash Codes) cont'd.

DFC	PROBABLE FAULT	FAULT ACTION *	CORRECTIVE ACTION FIRST CHECK
491 (29)	HbridgeFault_ETC Electronic Throttle Control Driver has failed. Indeterminate fault on Hbridge driver for electronic throttle control. Possibly either ETC+ or ETC- driver signals have been shorted to ground	(1) TurnOnMil (2) CutThrottle	Check ETC driver wiring for a shorted circuit SECM Pin A17 to ETC + Pin 1 SECM Pin A18 to ETC - Pin 4 <ul style="list-style-type: none"> Perform the throttle test using the Service Tool and re-check for fault Check the ETC internal motor drive by disconnecting the throttle connector and measuring the motor drive resistance at the throttle TPS Pin 1 (+DRIVER) to Pin 4 (-DRIVER) ~3.0-4.0Ω
521 (52)	LowOilPressureFault Low engine oil pressure	(1) TurnOnMil (2) DelayedEngine Shutdown	Check engine oil level Check electrical connection to the oil pressure switch SECM Pin B9 to Oil Pressure Switch
531 (53)	SysVoltRangeLow System voltage too low	TurnOnMil	Check battery voltage <ul style="list-style-type: none"> Perform maintenance check on electrical connections to the battery and chassis ground Check battery voltage during starting and with the engine running to verify charging system and alternator function Measure battery power at SECM with a multimeter (with key on) SECM Pin A23 (DRVP) to SECM Pin A16 (DRVG) SECM Pin A23 (DRVP) to SECM Pin B17 (DRVG)
541 (54)	SysVoltRangeHigh System voltage too high	(1) TurnOnMil (2) DelayedEngine Shutdown	Check battery and charging system voltage <ul style="list-style-type: none"> Check battery voltage during starting and with the engine running Check voltage regulator, alternator, and charging system Check battery and wiring for overheating and damage Measure battery power at SECM with a multimeter (with key on) SECM Pin A23 (DRVP) to SECM Pin A16 (DRVG) SECM Pin A23 (DRVP) to SECM Pin B17 (DRVG)

(*) Fault actions shown are default values specified by the OEM.

Table 2. Diagnostic Fault Codes (Flash Codes) cont'd.

DFC	PROBABLE FAULT	FAULT ACTION *	CORRECTIVE ACTION FIRST CHECK
551 (55)	SensVoltRangeLow Sensor reference voltage XDRP too low	(1) TurnOnMil (2) DelayedEngine Shutdown	Measure transducer power at the TMAP connector with a multimeter TMAP Pin 3 XDRP +5 Vdc to TMAP Pin 1 XDRG GND Verify transducer power at the SECM with a multimeter SECM Pin B24 +5 Vdc to SECM Pin B1 XDRG GND Verify transducer power at ETC with a multimeter ETC Pin 3 XDRP PWR to ETC Pin 2 XDRG GND Verify transducer power to the foot pedal with a multimeter.
561 (56)	SensVoltRangeHigh Sensor reference voltage XDRP too high	(1) TurnOnMil (2) DelayedEngine Shutdown	Measure transducer power at the TMAP connector with a multimeter TMAP Pin 3 XDRP +5 Vdc to TMAP Pin 1 XDRG GND Verify transducer power at the SECM with a multimeter SECM Pin B24 +5 Vdc to SECM Pin B1 XDRG GND Verify transducer power at ETC with a multimeter ETC Pin 3 XDRP PWR to ETC Pin 2 XDRG GND Verify transducer power to the foot pedal with a multimeter.
571 (57)	HardOverspeed Engine speed has exceeded the third level (3 of 3) of overspeed protection	(1) TurnOnMil (2) HardRevLimit (3) EngineShutdown	Usually associated with additional ETC faults • Check for ETC Sticking or other ETC faults Verify if the lift truck was motored down a steep grade
572	MediumOverspeed Engine speed has exceeded the second level (2 of 3) of overspeed protection	(1) TurnOnMil (2) MediumRevLimit (3) DelayedEngine Shutdown	Usually associated with additional ETC faults • Check for ETC Sticking or other ETC faults Verify if the lift truck was motored down a steep grade
573	SoftOverspeed Engine speed has exceeded the first level (1 of 3) of overspeed protection	(1) TurnOnMil (2) SoftRevLimit	Usually associated with additional ETC faults • Check for ETC Sticking or other ETC faults Verify if the lift truck was motored down a steep grade
611 (61)	APP1RangeLow APP1 sensor voltage out of range low, normally set if the APP1 signal has shorted to ground, circuit has opened or sensor has failed	TurnOnMil	Check foot pedal connector • Check APP1 signal at SECM PIN B7

(*) Fault actions shown are default values specified by the OEM.

Table 2. Diagnostic Fault Codes (Flash Codes) cont'd.

DFC	PROBABLE FAULT	FAULT ACTION *	CORRECTIVE ACTION FIRST CHECK
612 (65)	APP2RangeLow APP2 sensor voltage out of range low, normally set if the APP2 signal has shorted to ground, circuit has opened or sensor has failed	TurnOnMil	Check foot pedal connector • Check APP2 signal at SECM PIN B16
621 (62)	APP1RangeHigh APP1 sensor voltage out of range high, normally set if the APP1 signal has shorted to power or the ground for the sensor has opened	TurnOnMil	Check foot pedal connector • Check APP1 signal at SECM PIN B7
622 (66)	APP2RangeHigh APP2 sensor voltage out of range high, normally set if the APP2 signal has shorted to power or the ground for the sensor has opened	TurnOnMil	Check foot pedal connector • Check APP2 signal at SECM PIN B16
631 (63)	APP1AdaptLoMin Learned idle end of APP1 sensor range lower than expected	TurnOnMil	Check APP connector and pins for corrosion • Cycle the pedal several times and check APP1 signal at SECM Pin B7
632 (67)	APP2AdaptLoMin Learned idle end of APP2 sensor range lower than expected	TurnOnMil	Check APP connector and pins for corrosion • Cycle the pedal several times and check APP2 signal at SECM Pin B16
641 (64)	APP1AdaptHiMax Learned full pedal end of APP1 sensor range higher than expected	TurnOnMil	Check APP connector and pins for corrosion Cycle the pedal several times and check APP1 signal at SECM Pin B7
642 (68)	APP2AdaptHiMax Learned full pedal end of APP2 sensor range higher than expected	TurnOnMil	Check APP connector and pins for corrosion Cycle the pedal several times and check APP2 signal at SECM Pin B16
651	APP1AdaptHiMin Learned full pedal end of APP1 sensor range lower than expected	TurnOnMil	Check APP connector and pins for corrosion Cycle the pedal several times and check APP1 signal at SECM Pin B7
652	APP2AdaptHiMin Learned full pedal end of APP2 sensor range lower than expected	TurnOnMil	Check APP connector and pins for corrosion Cycle the pedal several times and check APP2 signal at SECM Pin B16
661	APP1AdaptLoMax Learned idle end of APP1 sensor range higher than expected	TurnOnMil	Check APP connector and pins for corrosion Cycle the pedal several times and check APP1 signal at SECM Pin B7
662	APP2AdaptLoMax Learned idle end of APP2 sensor range higher than expected	TurnOnMil	Check APP connector and pins for corrosion Cycle the pedal several times and check APP2 signal at SECM Pin B16
691 (69)	APP_Sensors_Conflict APP position sensors do no not track well, intermittent connections to APP or defective pedal assembly	(1) TurnOnMil (2) Cut Throttle	Check APP connector and pins for corrosion • Cycle the pedal several times and check APP1 signal at SECM Pin B7 • Cycle the pedal several times and check APP2 signal at SECM Pin B16

(*). Fault actions shown are default values specified by the OEM.

Table 2. Diagnostic Fault Codes (Flash Codes) cont'd.

DFC	PROBABLE FAULT	FAULT ACTION *	CORRECTIVE ACTION FIRST CHECK
711 (71)	LSDFault_Dither1 Dither Valve 1 Fault, signal has opened or shorted to ground or power or defective dither 1 valve	(1) TurnOnMil (2) Disable GasO2 Ctrl (3) Disable GasPost O2Ctrl	Check FTV1 for an open wire or FTV connector being disconnected FTV1 Pin 1 (signal) to SECM Pin A1 FTV1 Pin 2 (power) to SECM (DRVP) Pin A23 Check FTV1 for an open coil by disconnecting the FTV connector and measuring the resistance ($-26\Omega \pm 2\Omega$)
712	LSDFault_Dither2 Dither Valve 2 Fault, signal has opened or shorted to ground or power or defective dither 2 valve	(1) TurnOnMil (2) Disable GasO2 Ctrl (3) Disable GasPost O2Ctrl	Check FTV1 for an open wire or FTV connector being disconnected or signal shorted to GND FTV2 Pin 1 (signal) to SECM Pin A2 FTV2 Pin 2 (power) to SECM (DRVP) Pin A23 Check FTV1 for an open coil by disconnecting the FTV connector and measuring the resistance ($-26\Omega \pm 2\Omega$)
713	LSDFault_CSValve	None	N/A
714	LSDFault_CheckEngine Check Engine Lamp Fault, signal has opened or shorted to ground or power or defective check engine lamp	None	Check 'Check Engine Lamp' for an open wire or shorted to GND
715	LSDFault_CrankDisable Crank Disable Fault, signal has opened or shorted to ground or power or defective crank disable relay	None	N/A
716	LSDFault_FuelPump Fuel pump fault, signal has opened, shorted to ground or power, or defective fuel pump	TurnOnMil	Check fuel pump for an open wire or connector being disconnected or signal shorted to GND Fuel Pump Pin B (signal) from SECM Pin A13 Fuel Pump Pin A (power) from main relay 1 Pin A23 Check Fuel Pump for an open coil by disconnecting the Fuel Pump connector and measuring the resistance ($-26\Omega \pm 3\Omega$) Check for 12V to fuel pump
717	LSDFault_LockOff Fuel lock off Valve Fault, signal has opened or shorted to ground or power or defective Fuel lock off valve	TurnOnMil	Check fuel lock off valve for an open wire or connector being disconnected or signal shorted to GND Lock off Pin B (signal) from SECM Pin A11 Lock off Pin A (power) from main relay 1 Pin A23 Check lock off valve for an open coil by disconnecting the lock off valve connector and measuring the resistance ($-26\Omega \pm 3\Omega$) Check for 12V to lock off valve
718	LSDFault_MIL Malfunction Indicator Lamp Fault, signal has opened or shorted to ground or power or defective MIL lamp	None	None
721 (72)	GasFuelAdaptRangeLo In LPG mode, system had to adapt rich more than expected	(1) TurnOnMil (2) Disable GasO2 Ctrl (3) Disable GasPost O2Ctrl	Check for vacuum leaks. Check fuel trim valves, e.g. leaking valve or hose Check for missing orifice(s).
722	GasDesEquivLo In LPG mode, system had to adapt rich more than expected	None	N/A

(*) Fault actions shown are default values specified by the OEM.

Table 2. Diagnostic Fault Codes (Flash Codes) cont'd.

DFC	PROBABLE FAULT	FAULT ACTION *	CORRECTIVE ACTION FIRST CHECK
731 (73)	GasFuelAdaptRangeHi In LPG mode, system had to adapt lean more than expected	(1) TurnOnMil (2) Disable GasO2 Ctrl (3) Disable GasPost O2Ctrl	Check dual dither valves, e.g. plugged valve or hose. Check for plugged orifice(s).
732	GasDesEquipHi In LPG mode, system had to adapt rich more than expected	None	N/A
741 (74)	GasO2NotActive Pre-catalyst O2 sensor inactive on LPG, open O2 sensor signal or heater leads, defective O2 sensor	(1) TurnOnMil (2) DisableGas O2Ctrl (3) Disable GasPost O2Ctrl	Check that Pre-catalyst O2 sensor connections are OK. O2 (signal) Pin 3 to SECM Pin B13 O2 Pin 2 (HEATER GND) to SECM (DRVG GNG) Pins A16, B17 O2 Pin 1 (HEATER PWR) to SECM (DRVP + 12V) Pin A23 Verify O2 sensor heater circuit is operating by measuring heater resistance ($2.1\Omega \pm 0.4\Omega$) O2 Pin 2 (HEATER GND) to Pin 1 (HEATER PWR)
742	GasPostO2NotActive Post-catalyst O2 sensor inactive on LPG, open O2 sensor signal or heater leads, defective O2 sensor.	(1) TurnOnMil (2) DisableGasPost O2Ctrl	Check that Post-catalyst O2 sensor connections are OK. O2 (signal) Pin 3 to SECM Pin B19 O2 Pin 2 (HEATER GND) to SECM (DRVG GNG) Pins A16, B17 O2 Pin 1 (HEATER PWR) to Post O2 Heater Relay. Relay pin 87. This relay only turns on after engine has been running for some time and SECM has calculated that water condensation in exhaust has been removed by exhaust heat. Post O2 Heater Relay has SECM (DRVP + 12V) applied to the relay coil power. The relay coil ground is controlled by SECM Pin A20 to activate the relay to flow current through the post O2 heater. Verify O2 sensor heater circuit is operating by measuring heater resistance ($2.1\Omega \pm 0.4\Omega$) O2 Pin 2 (HEATER GND) to Pin 1 (HEATER PWR)
743	GasCatInactive	None	N/A
751	GasO2FailedLean Pre-catalyst O2 sensor indicates extended lean operation on LPG	(1) TurnOnMil (2) DisableGas O2Ctrl (3) Disable GasPost O2Ctrl	Check for vacuum leaks. Check dual dither valves, e.g. leaking valve or hose. Check for missing orifice(s).
752	GasPostO2FailedLean Pre-catalyst O2 sensor indicates extended lean operation on LPG	(1) TurnOnMil (2) DisableGasPost O2Ctrl	Correct other faults that may contribute to 752 (e.g. faults pertaining to dither valves, Pre-Cat O2, Post Cat O2 sensor) Check for vacuum leaks Check for leaks in exhaust, catalytic converter, HEGO sensors; repair leaks. Check all sensor connections (see fault 742 corrective actions).
771 (77)	GasO2FailedRich Pre-catalyst O2 sensor indicates extended rich operation on LPG	(1) TurnOnMil (2) DisableGas O2Ctrl (3) DisableGasPost O2Ctrl	Check dual dither valves, e.g. plugged valve or hose. Check for plugged orifice(s).

(*) Fault actions shown are default values specified by the OEM.

Table 2. Diagnostic Fault Codes (Flash Codes) cont'd.

DFC	PROBABLE FAULT	FAULT ACTION *	CORRECTIVE ACTION FIRST CHECK
772	GasPostO2FailedRich Pre-catalyst O2 sensor indicates extended rich operation on LPG	(1) TurnOnMil (2) DisableGasPost O2Ctrl	Correct other faults that may contribute to 772 (e.g. faults pertaining to FTVs, Pre-Cat O2, Post Cat O2 sensor) Look for leaks in exhaust, catalytic converter, HEGO sensors; repair leaks. Check all sensor connections (see fault 742 corrective actions).
821	LiqFuelAdaptRangeHi In Gasoline mode, system had to adapt lean more than expected	(1) TurnOnMil (2) Disable LiquidO2 Ctrl (3) Disable LiqPost O2Ctrl	Check for vacuum leaks. Low gasoline fuel pressure, perform gasoline pressure test. Injector problems, e.g. plugged, defective injector.
822	LiqDesEquivHi	None	N/A
831	LiqFuelAdaptRangeLow In Gasoline mode, system had to adapt rich more than expected	(1) TurnOnMil (2) Disable LiquidO2 Ctrl (3) Disable LiqPost O2Ctrl	Low gasoline fuel pressure, perform gasoline pressure test Injector problems, e.g. leaking, defective injector.
832	LiqDesEquivLo	None	N/A
841	LiqO2NotActive Pre-catalyst O2 sensor inactive on gasoline, open O2 sensor signal or heater leads, defective O2 sensor	(1) TurnOnMil (2) DisableLiqO2 O2Ctrl	Check that Pre-catalyst O2 sensor connections are OK. O2 (signal) Pin 3 to SECM Pin B13 O2 Pin 2 (HEATER GND) to SECM (DRVG GNG) Pins A16, B17 O2 Pin 1 (HEATER PWR) to SECM (DRVP + 12V) PIN A23 Verify O2 sensor heater circuit is operating by measuring heater resistance ($2.1\Omega \pm 0.4\Omega$) O2 Pin 2 (HEATER GND) to Pin 1 (HEATER PWR)
842	LiqPostO2NotActive Post-catalyst O2 sensor inactive on gasoline, open O2 sensor signal or heater leads, defective O2 sensor.	(1) TurnOnMil (2) DisableLiqPost O2Ctrl	Check that Post-catalyst O2 sensor connections are OK. O2 (signal) Pin 3 to SECM Pin B19 O2 Pin 2 (HEATER GND) to SECM (DRVG GNG) Pins A16, B17 O2 Pin 1 (HEATER PWR) to Post O2 Heater Relay. Relay pin 87. This relay only turns on after engine has been running for some time and SECM has calculated that water condensation in exhaust has been removed by exhaust heat. Post O2 Heater Relay has SECM (DRVP + 12V) applied to the relay coil power. The relay coil ground is controlled by SECM Pin A20 to activate the relay to flow current through the post O2 heater. Verify O2 sensor heater circuit is operating by measuring heater resistance ($2.1\Omega \pm 0.4\Omega$) O2 Pin 2 (HEATER GND) to Pin 1 (HEATER PWR)
843	LiqCatInactive	None	N/A
851	LiqO2FailedLean Pre-catalyst O2 sensor indicates extended lean operation on gasoline	(1) TurnOnMil (2) DisableLiqO2 O2Ctrl	Check for vacuum leaks. Low gasoline fuel pressure, perform gasoline pressure test. Injector problems, e.g. plugged, defective injector

(*) Fault actions shown are default values specified by the OEM.

Table 2. Diagnostic Fault Codes (Flash Codes) cont'd.

DFC	PROBABLE FAULT	FAULT ACTION *	CORRECTIVE ACTION FIRST CHECK
852	LiqPostO2FailedLean Pre-catalyst O2 sensor indicates extended lean operation on gasoline	(1) TurnOnMil (2) DisableLiqPostO2Ctrl	Correct other faults that may contribute to 852 (e.g. faults pertaining to Injectors, MAP, IAT, Pre-Cat O2, Post Cat O2 sensor) Look for leaks in exhaust, catalytic converter, HEGO sensors; repair leaks. Check all sensor connections (see fault 842 corrective actions).
871	LiqO2FailedRich Pre-catalyst O2 sensor indicates extended rich operation on gasoline	(1) TurnOnMil (2) DisableLiquidO2Ctrl	High gasoline fuel pressure, perform gasoline pressure test Injector problems, e.g. leaking, defective injector
872	LiqPostO2FailedRich Pre-catalyst O2 sensor indicates extended rich operation on gasoline	(1) TurnOnMil (2) DisableLiqPostO2Ctrl	Correct other faults that may contribute to 872 (e.g. faults pertaining to Injectors, MAP, IAT, Pre-Cat O2, Post Cat O2 sensor) Look for leaks in exhaust, catalytic converter, HEGO sensors; repair leaks. Check all sensor connections (see fault 842 corrective actions).
911	O2RangeLow Pre-catalyst O2 sensor voltage out of range low, sensor signal shorted to ground	None	N/A
912	O2_PostCatRangeLow Post-catalyst O2 sensor voltage out of range low, sensor signal shorted to ground	None	N/A
921	O2RangeHigh Pre-catalyst O2 sensor voltage out of range high, sensor signal shorted to power	(1) TurnOnMil (2) DisableLiquidO2Ctrl (3) DisableGasO2Ctrl	Check if O2 sensor installed before catalyst is shorted to +5Vdc or battery. O2 (signal) Pin 3 to SECM Pin B13 SECM (XDRP + 5V) Pin B24 SECM (DRVP + 12V) Pin A23
922	O2_PostCatRangeHigh Post-catalyst O2 sensor voltage out of range low, sensor signal shorted to ground	(1) TurnOnMil (2) Disable asoline Post-catalyst O2Ctrl (3) Disable LPG Post-catalyst O2Ctrl	Check if O2 sensor installed after catalyst is shorted to +5Vdc or battery. O2 (signal) Pin 3 to SECM Pin B19 Possible voltage sources: SECM (XDRP + 5V) Pin B24 and SECM (DRVP + 12V) Pin A23
931	FuelTempRangeLow Fuel Temperature Sensor Input is Low normally set if the fuel temperature sensor wire has shorted to chassis ground or the sensor has failed.	TurnOnMil	Check fuel temp sensor connector and wiring for a short to GND SECM (signal) Pin B14 to FTS Pin 1 SECM (sensor GND) Pin B1 to FTS Pin 2 SECM (system GND) Pin A16, B17
932	FuelTempRangeHigh Fuel Temperature Sensor Input is High normally set if the fuel temperature sensor wire has been disconnected or the circuit has opened to the SECM.	TurnOnMil	Check if fuel temp sensor connector is disconnected or for an open FTS circuit SECM (signal) Pin B14 to FTS Pin 1 SECM (sensor GND) Pin B1 to FTS Pin 2

(*) Fault actions shown are default values specified by the OEM.

Table 2. Diagnostic Fault Codes (Flash Codes) cont'd.

DFC	PROBABLE FAULT	FAULT ACTION *	CORRECTIVE ACTION FIRST CHECK
933	TransOilTemp Excessive transmission oil temperature	(1) TurnOnMil (2) DelayedEngine Shutdown	Refer to drivetrain manufacturer's transmission service procedures.
991	ServiceFault1 Service Interval 1 has been reached	None	Perform service procedure related to Service Interval 1 (determined by OEM)
992	ServiceFault2 Service Interval 2 has been reached	None	Perform service procedure related to Service Interval 2 (determined by OEM)
993	ServiceFault3 Service Interval 3 has been reached	None	Perform service procedure related to Service Interval 3 (determined by OEM)
994	ServiceFault4 Service Interval 4 has been reached-replace HEGO sensors	TurnOnMil	Replace Pre-catalyst HEGO sensor Replace Post-catalyst HEGO sensor
995	ServiceFault5 Service Interval 5 has been reached-replace timing belt	TurnOnMil	Replace engine timing belt

(*) Fault actions shown are default values specified by the OEM.

Mono-Ped Control System (Option)



Forward-Push the left side (2) of the pedal for FORWARD direction travel.



Neutral-The lift truck should not move when the Mono-Ped pedal is released..



Reverse-Push the right side (1) of the pedal for REVERSE direction travel.

The MONO-PED pedal controls the speed and direction of the lift truck. Pushing on the right side of the pedal (1) causes the lift truck to move in REVERSE. The optional reverse lights and optional back-up alarm will be ON in the REVERSE position. Pushing on the left side of the pedal (2) causes the lift truck to move in FORWARD.

The speed of the truck increases as the pedal is depressed

Auto Shift Controller ASC-100 (If Equipped)

Product Description

The Autoshift controller is an electrical control system, specially designed for use on forklift trucks with internal combustion engines.

Its primary purpose is to prevent the operator from driving the truck outside of the design parameters, e.g. selecting the reverse gear when traveling in excess of 5.1 km/h (3.17 mph) in a forward direction, and vice versa.

The Autoshift controller is mounted on a convenient position away from excessive heat sources and the truck's electrical system is retrofitted. An inductive speed sensor is mounted on the differential housing where it will pick up a pulse from a yoke tooth pattern. This pulse is used to monitor the truck in motion and its travel speed. To enable the system to change gears smoothly, the shift points for offset speed are adjustable.

The Autoshift controller prevents strain and abuse to the transmission. It also prevents damage to the half shaft, excessive tire wear and heat to the transmission.

WARNING

Improper operation or maintenance could result in injury or death. Do not operate or work on the lift truck unless you are properly trained. For safe operation, carefully read and follow this Operation and Maintenance Manual.

Adjustments

SW2 (Direction Inhibit Point)	
NOTCH	Vehicle Speed
0	3.3 km/h (2.05 mph)
1	3.6 km/h (2.24 mph)
2	3.9 km/h (2.42 mph)
3	4.2 km/h (2.61 mph)
4	4.5 km/h (2.80 mph)
5	4.8 km/h (2.98 mph)
6	5.1 km/h (3.17 mph)
7	5.4 km/h (3.36 mph)
8	5.7 km/h (3.54 mph)
9	6.0 km/h (3.73 mph)

Direction Inhibit Point

- This is accomplished on each machine with a factory - adjusted controller.
- The SW2 is for adjustment of optimal direction inhibit speed.
- Factory - setting value is 5.1 km/h (3.17 mph)
- SW1 is not used.

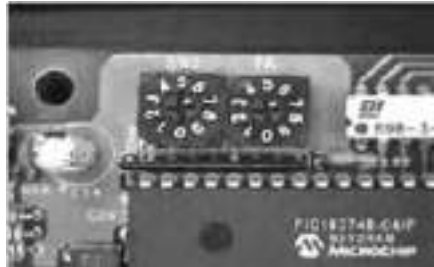

Adjustment Switch

Diagnostics Features

ASC-100 has an internal indicator on the right side of the controller for displaying the selected gear and the abnormal condition.

Below is a description applicable for many ASC-100 implementations.

Display for Operator

This information is given during normal operating when something special happens.

For example, on ASC-100's with the speed sensor, one of the indicators is used to indicate a sensor problem.

Display	Description	Remark
A	Automatic operation	
P	Speed sensor open	Flashing
F	Controller fault	Flashing
6	Forward Sol. Short	Flashing
7	Reverse Sol. Short	Flashing

Display for Troubleshooting

This information is input signal for diagnostics.

This test is used to verify an operation of direction control lever.

Display	Description	Remark
A	Automatic operation	
3	Forward s/w input	Lever input test
4	Reverse s/w input	Lever input test

Operation

This system can basically operate in 2 pre-selected modes.

- Automatic mode (Direction Inhibit mode): Selected as factory-setting.
- Manual mode (Fail-Safe mode): manual operation in emergency.

Automatic mode (Direction Inhibit mode)

- Start the engine. See topic "Starting the engine".
- Push down on the service brake pedal to hold the lift truck until ready to move it.
- Release the parking brake.
- Check diagnostics display on controller. See "Diagnostics Features".

NOTICE

The parking brake must be released before the direction control lever can be used.

- The gear direction is selected with the direction control lever.
- In automatic mode, if the turbine speed in a forward direction is higher than direction inhibit speed, though the reverse gear is selected by operator, the direction of travel will not be changed until the speed is reduced sufficiently by pushing down on the service brake pedal.

 **WARNING**

When you want to change the direction of travel, you must push down on the service brake pedal to reduce the travel speed.

In automatic mode, the lift truck's stopping distance may be longer than in manual mode. BE CAUTIOUS!

- When the directional change is completed, continue to push down on the accelerator pedal to obtain the desired travel speed.

Manual Mode (Fail-Safe mode)

The system still allows movement of the vehicle in case of controller breakdown by selecting the manual mode with the Fail-Safe mode Switch in the controller.

⚠ WARNING

In the manual mode, direction inhibition function can not be operated normally. The sudden reversal of a loaded lift truck traveling forward can cause the load to fall or the lift truck to tip.

If the controller fails

An operator can operate the truck manually by selecting the Manual mode with the Fail-Safe mode switch on the PCB (Printed Circuit Board).

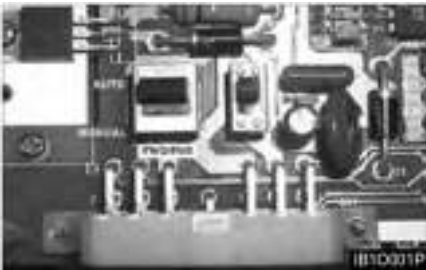

Fail-Safe mode switch

NOTICE

Direction Inhibit Function is usable in factory-setting controller. If you don't want to use this function, make sure to select the manual mode with the Fail-Safe mode switch on PCB.

Operating Techniques

Inching into Loads



Typical Example

1. Move the lift truck slowly FORWARD into position and engage the load. The lift truck should be square with load, forks spaced evenly between pallet stringers and as far apart as load permits.



Typical Example

2. Move the lift truck FORWARD until the load touches the carriage.

Lifting the Load

1. Lift the load carefully and tilt the mast back a short distance.



Typical Example

2. Tilt the mast further back to cradle the load.



Typical Example

3. Operate the lift truck in reverse until the load is clear of the other material.
4. Lower the cradled load to the travel position.

NOTE: Lift and tilt speeds are controlled by engine rpm.

Traveling With the Load

NOTICE

Travel with the load as low as possible, while still maintaining ground clearance.



Typical Example

1. Travel with the load uphill on upgrades and downgrades.

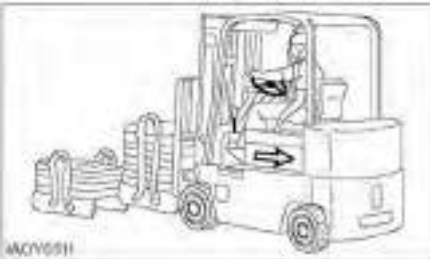

Typical Example

2. For better vision, travel in reverse with bulky loads.

Unloading

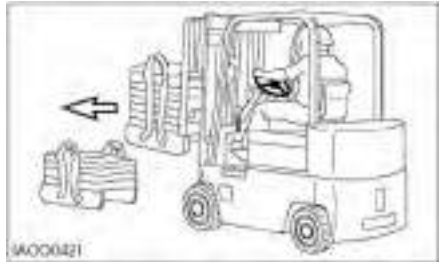

Typical Example

1. Move the lift truck into the unloading position.



Typical Example

2. Tilt the mast FORWARD only when directly over the unloading area.

WARNING

Do not tilt the mast forward with the load unless directly over the unloading area, even if the power is off.

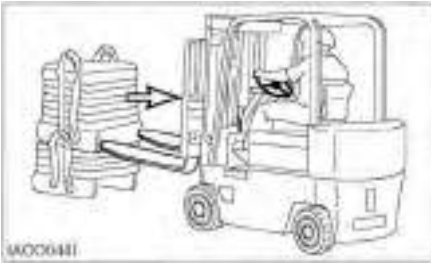

Typical Example

3. Deposit the load and BACK away carefully to disengage the forks.



Typical Example

4. Lower the carriage and forks to the travel position or to the park position.

Turning



1. When turning sharp corners, keep close to the inside corner. Begin the turn when the inside drive wheel meets the corner.



2. In narrow aisles, keep away from the stockpile when turning into the aisle. Allow for counter weight swing.

Lifting Drums or Round Objects

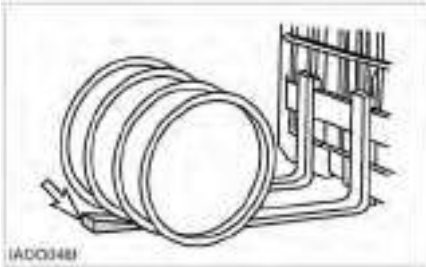

1. Block drums or round objects. Tilt the mast FORWARD and slide the fork tips along the floor to get under the load.

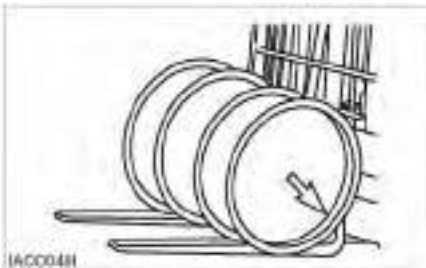

2. Before lifting, tilt the mast BACK slightly until the load is cradled on the forks.

Operating in hot weather

Keep the following points in mind when you operate the lift truck in hot weather.

1. Check the radiator. Clogging can cause overheating. Clean them out regularly with a blast of compressed air, also, check for leakage of water.
2. Check the fan belt tension and adjust to proper tension.
3. Even if the engine overheats and the coolant boils over, let the engine idle for a while with opening engine hood until temperature falls before shutting off the engine.

Parking the Lift Truck



NOTE: Park the lift truck level with the fork lowered and the mast tilted forward until the fork touches the floor. Block the drive wheels when parking on an incline.

1. Park in an authorized area only. Do not block traffic. If LP equipped, do not park near elevator shafts or any other area where LP could collect in a pocket (low area), causing a potentially dangerous condition.



2. Place the transmission controls in NEUTRAL.
3. Engage the parking brake.
4. Tilt the mast forward and lower the fork to the ground.

⚠ WARNING

Blocking the wheels will prevent unexpected lift truck movement, which could cause personal injury.

5. Turn the key in the ignition switch to the OFF position and remove the key.



NOTE: If a LP equipped lift truck is stopped or parked for an indefinite or prolonged period of time, shut off the LP fuel tank valve.

6. Actuate each loading lever several times to remove the residual pressure in the respective cylinders and hoses.

If Parking Brake Alarm Equipped

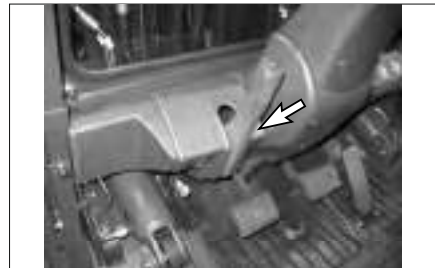

⚠ WARNING

When leaving machine apply parking brake! Parking brake is not automatically applied. Alarm will sound if parking brake is not applied.

Lift Fork Adjustment

⚠ WARNING

When adjusting the fork spread, be careful not to pinch your hand between forks and the carriage slot.

Hook-on type Fork



1. Move up the hook pin to the free position.
2. Raise the hook pin in each fork to side the fork on the carriage bar.
3. Adjust the forks in the position most appropriate for the load and as wide as possible for load stability.
4. When adjusting the forks, make sure that the weight of the load is centered on the truck.
5. After adjustment, set the fork locks to keep the forks in place.

⚠ WARNING

Make sure the forks are locked before carrying a load.

Storage Information

Before Storage

Before storing your lift truck, clean and inspect as the following procedures.

- Wipe away grease, oil, etc. adhering to the body of the truck with waste cloth, and use water, if needed.
- While cleaning the truck, check general condition of the truck. Especially check the truck body for dents or damage and tires for wear or nails or stones in the tread.
- Fill the fuel tank with fuel specified.
- Check for leakage of hydraulic oil, engine oil, fuel, or coolant, etc.
- Apply grease, where needed.
- Check for looseness of nuts and bolts, especially hub nuts.
- Check mast rollers to see that they rotate smoothly.
- Prime the oil into the lift cylinders by actuating the lift lever all the way several times.
- Drain off coolant completely in cold weather, if antifreeze is not used.

Long Time Storage

Perform the following service and checks in addition to the "Parking the lift truck" services.

- Taking the rainy season into consideration, park the machine at a higher and hard ground.
- Avoid parking on soft grounds such as an asphalt ground in summer.
- Dismount the battery from the machine. Even though the machine is parked indoors, if the place is hot or humid, the battery should be kept in a dry, cool place. Charge the battery once a month.
- Apply antirust to the exposed parts which tend to rust.
- Cover components such as the breather and air cleaner which may be caught with humidity.
- The machine should be operated at least once a week. Fill the cooling system, if cooling water is discharged, and mount the battery. Start the engine and warm up thoroughly. Move the machine a little forwards and backwards. Operate the hydraulic controls several times.

To Operate the Lift Truck after a Long Time Storage

- Remove covers and antirust from each of the components and exposed parts.
- Drain the engine crankcase, transmission (clutch type machine), differential and final reduction gear, clean the inside of them and add new oil.
- Drain off foreign matter and water from the hydraulic oil tank and fuel tank.
- Remove the head cover from the engine cylinder. Oil valves and rocker shaft and check each valve for proper operation.
- Add cooling water to the specified level.
- Charge the battery and mount it on the machine. Connect the cables.
- Perform pre - operational checks carefully. (refer to "Before Starting the Engine")
- Warm up the machine.

Transportation Hints

Lift Truck Shipping

Check travel route for overpass clearances. Make sure there is adequate clearance if the lift truck being transported is equipped with a high mast, overhead guard or cab.

To prevent the lift truck from slipping while loading, or shifting in transit, remove ice, snow or other slippery material from the loading dock and the truck bed before loading.

NOTICE

Obey all state and local laws governing the height, weight, width and length of a load.
Observe all regulations governing wide loads.

NOTICE

Remove ice, snow or other slippery material from the shipping vehicle and the loading dock.

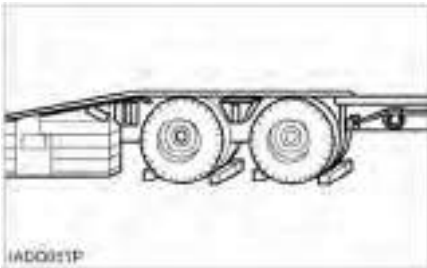

Always block the trailer or the rail car wheels before loading the lift truck.

Position the lift truck on the truck bed or the rail car.

Apply the parking brake and place the transmission control in NEUTRAL.

Tilt the mast forward and lower forks to the floor.

Turn the ignition switch to the OFF position and remove the key. If LP equipped, shut off the LP fuel tank.

Block the wheels and secure the lift truck with tiedowns.

Machine Lifting and Tiedown Information

NOTICE

Improper lifting or tiedowns can allow load to shift and cause injury and/or damage.

1. Weight and instructions given herein apply to lift trucks as manufactured by DOOSAN.
2. Use proper rated cables and slings for lifting. Position the crane for level lift truck lift.
3. Spreader bar widths should be sufficient to prevent contact with the lift truck.
4. Use the tiedown locations provided for lift truck tiedown.

Check the state and local laws governing weight, width and length of a load.

Contact your DOOSAN Lift Truck dealer for shipping instructions for your lift truck.

Towing Information

⚠ WARNING

Personal injury or death could result when towing a disabled lift truck incorrectly.

Block the lift truck wheels to prevent movement before releasing the brakes. The lift truck can roll free if it is not blocked.

Follow the recommendations below, to properly perform the towing procedure.

These towing instructions are for moving a disabled lift truck a short distance, at low speed, no faster than 2 km/h (1.2 mph), to a convenient location for repair. These instructions are for emergencies only. Always haul the lift truck if long distance moving is required.

Shield must be provided on the towing lift truck to protect the operator if the tow line or bar should break.

Do not allow riders on the lift truck being towed unless the operator can control the steering and/or braking.

Before towing, make sure the tow line or bar is in good condition and has enough strength for the towing situation involved. Use a towing line or bar with a strength of at least 1.5 times the gross weight of the towing lift truck for a disabled lift truck stuck in the mud or when towing on a grade.

Keep the tow line angle to a minimum. Do not exceed a 30° angle from the straight ahead position. Connect the tow line as low as possible on the lift truck that is being towed.

Quick lift truck movement could overload the tow line or bar and cause it to break. Gradual and smooth lift truck movement will work better.

Normally, the towing lift truck should be as large as the disabled lift truck. Satisfy yourself that the towing lift truck has enough brake capacity, weight and power, to control both lift trucks for the grade and the distance involved.

To provide sufficient control and braking when moving a disabled lift truck downhill, a larger towing lift truck or additional lift trucks connected to the rear could be required. This will prevent uncontrolled rolling.

The different situation requirements cannot be given, as minimal towing lift truck capacity is required on smooth level surfaces to maximum on inclines or poor surface conditions.

Consult your DOOSAN Lift Truck dealer for towing a disabled lift truck.

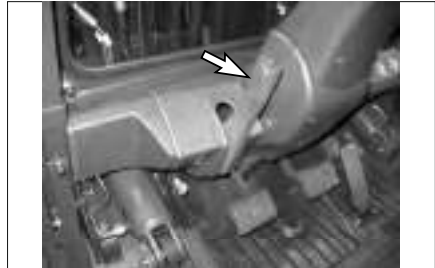

1. Release the parking brake.

NOTICE

Release the parking brake to prevent excessive wear and damage to the parking brake system.

2. Check that the service brake pedal is released.
3. Key switch is in the OFF position.
4. Direction control lever is in neutral.
5. Fasten the tow bar to the lift truck.
6. Remove the wheel blocks. Tow the lift truck slowly. Do not tow any faster than 2 km/h (1.2 mph).

⚠ WARNING

Be sure all necessary repairs and adjustments have been made before a lift truck that has been towed to a service area is put back into operation.

Inspection, Maintenance and Repair of Lift Truck Forks

The following section gives practical guidelines for inspection, maintenance and repair of lift truck forks. It also provides general information on the design and application of forks and the common cause of fork failures.

Lift truck forks can be dangerously weakened by improper repair or modification. They can also be damaged by the cumulative effects of age, abrasion, corrosion, overloading and misuse.

A fork failure during use can cause damage to the equipment and the load. A fork failure can also cause serious injury.

A good fork inspection and maintenance program along with the proper application can be very effective in preventing sudden failures on the job.

Repairs and modifications should be done only by the fork manufacturer or a qualified technician who knows the material used and the required welding and heat treatment process.

Users should evaluate the economics of returning the forks to the manufacturer for repairs or purchasing new forks. This will vary depending on many factors including the size and type of fork.

Forks should be properly sized to the weight and length of the loads, and to the size of the machine on which they are used. The general practice is to use a fork size such that the combined rated capacity of the number of forks used is equal to or greater than the "Standard (or rated) Capacity" of the lift truck.

The individual load rating, in most cases, will be stamped on the fork in a readily visible area. This is generally on the top or side of the fork shank.

- A fork rated at 1500 pounds at 24 inch load center will be stamped 1500x24.
- A fork rated at 2000 kg at 600 mm load center will be stamped 2000x600.

The manufacturer identification and year and date of manufacture are also usually shown.

Some countries have standards or regulations which apply specifically to the inspection and repair of forks.

Users may also refer to the International Organization For Standardization-ISO Technical Report 5057- Inspection and Repair of Fork Arms and ISO Standard 2330 - Fork Arms - Technical Characteristics and Testing.

While there are no specific standards or regulations in the United States, users should be familiar with the requirements for inspection and maintenance of lift trucks as provided by the 29 Code Federal Register 1910.178 Powered Industrial Truck, and ANSI/ASME Safety Standard(s) B56.1, B56.5 or B56.6 as applicable to the type of machine(s) in use.

Environment Protection

When servicing this lift truck, use an authorized servicing area and an approved container to collect coolant, oil, fuel, grease, electrolyte and any other potential environmental pollutant before any lines, fittings or related items are disconnected or removed. After servicing, dispose of those materials in an authorized place and container. When cleaning the lift truck, be sure to use an authorized area.

Causes of Fork Failure

Improper Modification or Repair

Fork failure can occur as a result of a field modification involving welding, flame cutting or other similar processes which affect the heat treatment and reduces the strength of the fork.

In most cases, specific processes and techniques are also required to achieve proper welding of the particular alloy steels involved. Critical areas most likely to be affected by improper processing are the heel section, the mounting components and the fork tip.

Bent or Twisted Forks

Forks can be bent out of shape by extreme overloading, glancing blows against walls or other solid objects or using the fork tip as a pry bar.

Bent or twisted forks are much more likely to break and cause damage or injury. They should be removed from service immediately.

Fatigue

Parts which are subjected to repeated or fluctuating loads can fail after a large number of loading cycles even though the maximum stress was below the static strength of the part.

The first sign of a fatigue failure is usually a crack which starts in an area of high stress concentration. This is usually in the heel section or on the fork mounting.

As the crack progresses under repetitive load cycling, the load bearing cross section of the remaining metal is decreased in size until it becomes insufficient to support the load and complete failure occurs.

Fatigue failure is the most common mode of fork failure. It is also one which can be anticipated and prevented by recognizing the conditions which lead up to the failure and by removing the fork service prior to failing.

- Repetitive Overloading

Repetitive cycling of loads which exceeds the fatigue strength of the material can lead to fatigue failure. The overload could be caused by loads in excess of the rated fork capacity and by use of the forks tips as pry bars. Also, by handling loads in a manner which causes the fork tips to spread and the forks to twist laterally about their mountings.

- Wear

Forks are constantly subjected to abrasion as they slide on floors and loads. The thickness of the fork blade is gradually reduced to the point where it may not be capable of handling the load for which it was designed.

- Stress Risers

Scratches, nicks and corrosion are points of high stress concentration where cracks can develop. These cracks can progress under repetitive loading in a typical mode of fatigue failure.

Overloading

Extreme overloading can cause permanent bending or immediate failure of the forks. Using forks of less capacity than the load or lift truck when lifting loads and using forks in a manner for which they were not designed are some common causes of overloading.

Fork Inspection



Establish a daily and 12 month inspection routine by keeping a record for the forks on each lift truck. Initial information should include the machine serial number on each the forks are used, the fork manufacturer, type, original section size, original length and capacity. Also list any special characteristics specified in the fork design.

Record the date and results of each inspection, making sure the following information is included.

- Actual wear conditions, such as percent of original blade thickness remaining.
- Any damage, failure or deformation which might impair the use of the truck.
- Note any repairs or maintenance.

An ongoing record of this information will help in identifying proper inspection intervals for each operation, in identifying and solving problem areas and in anticipating time for replacement of the forks.

First Installation

1. Inspect forks to ensure they are the correct size for the truck on which they will be used. Make sure they are the correct length and type for the loads to be handled.

If the forks have been previously used, perform the "12 Month Inspection".

If the forks are rusted, see "Maintenance and Repair".

2. Make sure fork blades are level to each other within acceptable tolerances. See "Forks, Step 4," in the "2000 Service Hours or Yearly" in "Maintenance Intervals"
3. Make sure positioning lock is in place and working. Lock forks in position before using truck. See "Forks, Step 7", in the "2000 Service Hours or Yearly" in "Maintenance Intervals".

Daily Inspection

1. Visually inspect forks for cracks, especially in the heel section, around the mounting brackets, and all weld areas. Inspect for broken or jagged fork tips, bent or twisted blades and shanks.
2. Make sure positioning lock is in place and working. Lock the forks in position before using the truck. See "2000 Service Hours or Yearly" in "Maintenance Intervals".
3. Remove all defective forks from service.

12 Months Inspection

Forks should be inspected, at a minimum, every 12 months. If the truck is being used in a multi-shift or heavy duty operation, they should be checked every six months. See "Forks" in the "2000 Service Hours or Yearly" in "Maintenance Intervals."

Maintenance and Repair

1. Repair forks only in accordance with the manufacturer's recommendations.

Most repairs or modifications should be done only by the original manufacturer of the forks or an expert knowledgeable of the materials, design, welding and heat treatment process.

2. The following repairs or modifications SHOULD NOT be attempted.

- Flame cutting holes or cutouts in fork blades.
- Welding on brackets or new mounting hangers.
- Repairing cracks or other damage by welding.
- Bending or resetting.

3. The following repairs MAY be performed.

- Forks may be sanded or lightly ground, to remove rust, corrosion or minor defects from the surfaces.
- Heel sections may be ground with a carbon stone to remove minor surface cracks or defects. Polish the inside radius of the heel section to increase the fatigue life of the fork. Always grind or polish in the direction of the blade and shank length.
- Repair or replace the positioning locks on hook type forks.
- Repair or replace most fork retention devices used with other fork types.

4. A fork should be load tested before being returned to service on completion of repairs authorized and done in accordance with the manufacturer's recommendations.

Most manufacturers and standards require the repaired fork to be tested with a load 2.5 times the specified capacity and at the load center marked on the fork arm.

With the fork restrained in the same manner as its mounting on the lift truck, apply the test load twice, gradually and without shock. Maintain the test for 30 seconds each time.

Check the fork arm before and after the second application of the test load. It shall not show any permanent deformation.

Consult the fork manufacturer for further information as may be applicable to the specific fork involved.

Testing is not required for repairs to the positioning lock or the markings.

Tire Inflation Information

Tire Inflation

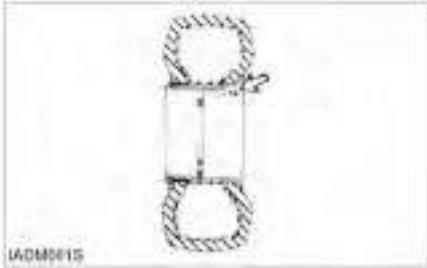

WARNING

Personal injury or death could result when tires are inflated incorrectly.

Use a self - attaching inflation chuck and stand behind the tread when inflating a tire.

Proper inflation equipment and training in using the equipment are necessary to avoid over-inflation. A tire blowout or rim failure can result from improper or misused equipment.

NOTICE

Set the tire inflation equipment regulator at no more than 140 kPa (20 psi) over the recommended tire pressure.

Tire Shipping Pressure

The tire inflation pressures shown in the following chart are cold inflation shipping pressures.

Size	Ply Rating or Strength Index	Shipping Pressure	
		kPa	psi
6.5X10	10	790	115
7.0X15	12	825	120
28X9-15	12	825	120

¹ Standard tire, ply rating and inflation pressures.

The operating inflation pressure is based on the weight of a ready - to - work machine without attachments, at rated payload, and in average operating conditions. Pressures for each application may vary and should always be obtained from your tire supplier.

NOTE: Fill tires to the recommended pressures listed \pm 35 kPa (5 psi). Tires can be filled with nitrogen.

Tire Inflation Pressures Adjustment

Tire inflation in a warm shop area, 18° to 21°C (65° to 70°F), will be underinflated if the machine works in freezing temperatures. Low pressure shortens the life of a tire.

Torque Specifications

Metric Hardware

Most of the nuts, bolts, studs, and threaded holes in your lift truck are metric. In this manual we provide specifications in both metric and U.S. customary measurement. Always replace metric hardware with metric hardware. See the parts books for proper replacement.

NOTE: For proper fit, use only metric tools on metric hardware. Non-metric tools might slip and cause injury.

Torque for Standard Hose Clamps - Worm Drive

NOTICE

The chart below gives the torques for initial installation of hose clamps on new hose and for reassembly or retightening of hose clamps on existing hose.

Clamp Width	Initial Installation Torque On New Hose	
	N•m ¹	lb•in
16 mm (.625 in)	7.5 ± 0.5	65 ± 5
13.5 mm (.531 in)	4.5 ± 0.5	40 ± 5
8 mm (.312 in)	0.9 ± 0.2	8 ± 2
Clamp Width	Reassembly or Retightening Torque On Existing Hose	
	N•m ¹	lb•in
16 mm (.625 in)	4.5 ± 0.5	40 ± 5
13.5 mm (.531 in)	3.0 ± 0.5	25 ± 5
8 mm (.312 in)	0.7 ± 0.2	6 ± 2

¹1 Newton meter (N•m) is approximately the same as 0.1 kg•m.

Torque for Standard Bolts, Nuts, and Taperlock Studs

NOTICE

The two charts below give general torques for bolts, nuts, and taperlock studs of SAE Grade 5 or better quality.

Torques for Bolts and Nuts with Standard Threads

Thread Size Inch	Standard Nut and Bolt Torque	
	N•m	lb•ft
1/4	12 ± 4	9 ± 3
5/16	25 ± 7	18 ± 5
3/8	45 ± 7	33 ± 5
7/16	70 ± 15	50 ± 11
1/2	100 ± 15	75 ± 11
9/16	150 ± 20	110 ± 15
5/8	200 ± 25	150 ± 18
3/4	360 ± 50	270 ± 37
7/8	570 ± 80	420 ± 60
1	875 ± 100	640 ± 75
1 1/8	1100 ± 150	820 ± 110
1 1/4	1350 ± 175	1000 ± 130
1 3/8	1600 ± 200	1180 ± 150
1 1/2	2000 ± 275	1480 ± 200

¹1 Newton meter (N•m) is approximately the same as 0.1 kg•m.

Torques for Taperlock Studs

Thread Size Inch	Standard Taperlock Stud Torque	
	N•m ¹	lb•ft
1/4	8 ± 3	6 ± 2
5/16	17 ± 5	13 ± 4
3/8	35 ± 5	26 ± 4
7/16	45 ± 10	33 ± 7
1/2	65 ± 10	48 ± 7
5/8	110 ± 20	80 ± 15
3/4	170 ± 30	125 ± 22
7/8	260 ± 40	190 ± 30
1	400 ± 60	300 ± 45
1/8	500 ± 700	370 ± 50
1/4	650 ± 80	480 ± 60
3/8	750 ± 90	550 ± 65
1/2	870 ± 100	640 ± 75

¹1 Newton meter (N•m) is approximately the same as 0.1 kg•m.

Torque for Metric Fasteners

NOTICE

Be very careful never to mix metric with U.S. customary (standard) fasteners. Mismatched or incorrect fasteners will cause lift truck damage or malfunction and may even result in personal injury.

Original fasteners removed from the lift truck should be saved for reassembly whenever possible. If new fasteners are needed, they must be of the same size and grade as the ones that are being replaced.

The material strength identification is usually shown on the bolt head by numbers (8.8, 10.9, etc.). This chart gives standard torques for bolts and nuts with Grade 8.8.

NOTE: Metric hardware must be replaced with metric hardware. Check parts book.

Thread Size Metric	Standard Torque	
	N•m ¹	lb•ft
M6	12 ± 4	9 ± 3
M8	25 ± 7	18 ± 5
M10	55 ± 10	41 ± 7
M12	95 ± 15	70 ± 11
M14	150 ± 20	110 ± 15
M16	220 ± 30	160 ± 22
M20	450 ± 70	330 ± 50
M24	775 ± 100	570 ± 75
M30	1600 ± 200	1180 ± 150
M36	2700 ± 400	2000 ± 300

¹1 Newton meter (1 N•m) is approximately the same as 0.1 kg•m.

²ISO - International Standards organization.

Cooling System Specifications

Coolant Information

NOTE: The following information is generic and valid for lift trucks.

Engine operating temperatures have increased to improve engine efficiency. This means proper cooling system maintenance is especially important. Overheating, overcooling, pitting, cavitation erosion, cracked heads, piston seizures, and plugged radiators are classic cooling system failures. In fact, coolant is as important as the quality of fuel and lubricating oil.

Filling at over 20 liters (5 U.S. gallons) per minute can cause air pockets in the cooling system.

After draining and refilling the cooling system, operate the engine with the radiator cap removed until the coolant reaches normal operating temperature and the coolant level stabilizes. Add coolant as necessary to fill the system to the proper level.

Never operate without a thermostat in the cooling system. Cooling system problems can arise without a thermostat.

NOTICE

DOOSAN recommends that the coolant mixture contain 50% commercially available automotive antifreeze, and 50% water.

The coolant mix with concentration of antifreeze smaller than 30% does not provide sufficient corrosion protection. Concentrations over 60% adversely affect freeze protection and heat transfer rates.

Never add coolant to an overheated engine, engine damage can result. Allow the engine to cool first. If the machine is to be stored in, or shipped to, an area with freezing temperatures, the cooling system must be protected to the lowest expected outside (ambient) temperature.

The engine cooling system is normally protected to -28°C (-20°F) with antifreeze, when shipped from the factory unless special requirements are defined.

Check the specific gravity of the coolant solution frequently in cold weather to ensure adequate protection.

Clean the cooling system if it is contaminated, the engine overheats or foaming is observed in the radiator.

Old coolant should be drained, the system cleaned and new coolant added every 2000 service hours or yearly.

Refer to topic, "Cooling System - Clean, Change" in Every 2000 Service Hours or Yearly section.

Coolant Water

Hard water, or water with high levels of calcium and magnesium ions, encourages the formation of insoluble chemical compounds by combining with cooling system additives such as silicates and phosphates.

The tendency of silicates and phosphates to precipitate out-of-solution increases with increasing water hardness. Hard water or water with high levels of calcium and magnesium ions encourages the formation of insoluble chemicals, especially after a number of heating and cooling cycles.

DOOSAN prefers the use of distilled water or deionized water to reduce the potential and severity of chemical insolubility.

Acceptable Water	
Water Content	Limits (PPM)
Chlorides (Cl)	50 maximum
Sulfates (SO ₄)	50 maximum
Total hardness	80mg/l
Total solids	250 maximum
PH	6.0 to 8.0

ppm = parts per million

Using water that meets the minimum acceptable water requirement may not prevent drop-out of these chemical compounds totally, but should minimize the rate to acceptable levels.

Antifreeze

NOTICE

DOOSAN recommends using automotive antifreeze suitable for gasoline engines having aluminum alloy parts. Antifreeze of poor quality will cause corrosion of the cooling system, and thus always use automotive antifreeze prepared by a reliable maker, and never use it mixed with antifreeze of different brand.

DOOSAN recommends that the coolant mix contain 50% commercially available automotive antifreeze, or equivalent and acceptable water to maintain and adequate water pump cavitation temperature for efficient water pump performance. Premix coolant solution to provide protection to the lowest expected outside (ambient) temperature. Pure undiluted antifreeze will freeze at -23°C (-10°F).

Use a greater concentration (above 50%) of commercially available automotive antifreeze only as needed for anticipated outside (ambient) temperatures. Do not exceed the recommendations, provided with the commercially available automotive antifreezes, regarding the coolant mixture of antifreeze to water.

Make proper antifreeze additions.

Adding pure antifreeze as a makeup solution for cooling system top-up is an unacceptable practice. It increases the concentration of antifreeze in the cooling system which increases the concentration of dissolved solids and undissolved chemical inhibitors in the cooling system. Add antifreeze mixed with water to the same freeze protection as your cooling system.

Use the chart below to assist in determining the concentration of antifreeze to use.

Antifreeze Concentrations	
Protection Temperature	Concentrations
Protection to -15°C (5°F)	30% antifreeze and 70% water
Protection to -23°C (-10°F)	40% antifreeze and 60% water
Protection to -37°C (-34°F)	50% antifreeze and 50% water
Protection to -51°C (-60°F)	60% antifreeze and 40% water

Fuel Specifications

General Fuel Information

Use only fuel as recommended in this section.

NOTICE

Fill the fuel tank at the end of each day of operation to drive out moisture laden air and to prevent condensation. Maintain a constant level near the top of the day tank to avoid drawing moisture into the tank as the level decreases.

Do not fill the tank to the top. Fuel expands as it gets warm and can overflow.

Do not fill the fuel filters with fuel before installing them. Contaminated fuel will cause accelerated wear to the fuel system parts.

Drain the water and sediment from main fuel storage tank before it is refilled. This will help prevent water and/or sediment from being pumped from the fuel storage tank into the engine fuel tank.

Diesel Specifications

Fuel Types

DOOSAN Diesel Engines have the ability to burn a wide variety of fuels. These fuels are divided into two general groups, preferred and permissible.

The **Preferred Fuels** provide maximum engine service life and performance. They are distillate fuels. They are commonly called diesel fuel, MDO diesel, furnace oil, gas oil or kerosene (for cold weather operation).

Experience has proven that distillate fuels meeting the following basic specifications will result in optimum engine performance and durability.

DOOSAN strongly encourages the use of fuels that meet the Preferred Fuels specification.

The permissible fuels are crude oils or blended fuels. Use of these fuels can result in higher maintenance costs and reduced engine service life.

Crude oil is used to describe oils/fuels that are not refined and are in the original state as when pumped from the ground. Certain types of crude oils can be burned in DOOSAN Engines.

PREFERRED DISTILLATE FUEL FOR DIESEL ENGINES	
Specifications	Requirements*
Aromatics (AST D1319)	35% Max.
Ash (ASTM D482)	0.02% Weight Max.
Cetane Number (ASTM D613)	35Min. for 45 max. 40 Min. for DI Engines
Cloud Point (ASTM D287)	Not Above Lowest Expected Ambient Temperature
Gravity API (ASTM D287)	30 Min. and 45 Max.
Pour Point (ASTM D97)	6°C (10°F) Below Ambient Min.
Sulfur (ASTM D2788, D3605 or D1552)	0.5% Max. (See Sulfur Topic)
Viscosity, Kinematic @ 38°C (100°F) (ASTM D445)	20.0 cSt Max. 1.4 cSt Min.
Water & Sediment (ASTM D1796)	0.01% Max.

*As delivered to fuel system

Fuel Sulfur Content

The percentage of sulfur in the fuel will affect the engine oil recommendations. Fuel sulfur is chemically changed during combustion to form both sulfurous and sulfuric acid. These acids chemically attack metal surfaces and cause corrosive wear.

Certain additives used in lubricating oils contain alkaline compounds that are formulated to neutralize these acids. The measure of this reserve alkalinity in lubricating oil is known as its Total Base Number (TBN). TBN is essential to neutralize the acids from combustion gases and to minimize corrosive wear.

Any API classification performance of oil should have sufficient TBN for fuels with less than 0.5% sulfur. For fuels with 0.5% to 1.5% sulfur by weight, engine oil must have a TBN of 20 times the percentage of fuel sulfur as measured by the ASTM (American Society of Testing Materials) D-2896 method. (ASTM D-2896 can normally be found at your local technological society, library or college).

DOOSAN recommends infrared analysis (in conjunction with wear metal analysis) of used oil in determining the effectiveness of oil TBN and acid neutralization.

For fuel with sulfur exceeding 1.5% by weight, use oil with a TBN of 30 and reduce the oil change interval by one half. Also, infrared analysis and wear metal analysis should be used to establish oil change intervals.

Periodically request fuel sulfur content information from your fuel supplier. Fuel sulfur content can change with each bulk delivery.

Gasoline Specifications

Only unleaded gasoline should be used for DOOSAN forklift trucks.

The gasoline in which methanol is contained is not recommended. The gasoline in which ethanol is contained is not recommended, either.

It is recommended to use gasoline fuel that has octane number 87, to prevent knocking trouble.

LP Specifications

LP is "liquefied petroleum gas". The exact composition of LP varies slightly between different parts of the country and different refineries. HD5 or HD10 is recommended for DOOSAN forklift trucks.

Composition of HD5	
Propane (C ₃ H ₈)	90.0 %
Propylene	up to 5 %
Butane (C ₄ H ₁₀)	2.0 %
iso - Butane	1.5 %
Methane (CH ₄)	1.5 %
Total	100 %

WARNING

Remember LP is heavier than air and will sink to the lowest spot possible. Avoid areas near floor drains or lubrication pits where escaped fuel may collect.

Lubricant Information

Lubricant Information

Certain abbreviations follow Society of Automotive Engineers (SAE) J754 nomenclature and some classifications follow SAE J183 abbreviations.

The MIL specifications are U.S.A. Military Specifications.

The recommended oil viscosities can be found in the Lubricant Viscosities chart in this publication.

Grease is classified by the National Lubricating Grease Institute (NLGI) based on ASTM D217-68 Worked Penetration characteristics which are given a defined consistency number.

Engine Oil (DEO and EO)

The following oil specifications provide guidelines for the selection of commercial products:

- Gasoline/LP Engine : API SJ or higher
- Diesel Engine : API CH4, ACEA E5

NOTICE

Failure to follow the oil recommendations can cause shortened engine life due to carbon deposits or excessive wear.

Consult the EMA Lubricating Oils Data Book for a listing of oil brands.

NOTE: The percentage of sulfur in the fuel will affect the engine oil recommendations. For fuel sulfur effects, the Infrared Analysis or the ASTM D2896 procedure can be used to evaluate the residual neutralization properties of engine oil. The sulfur products formation depends on the fuel sulfur content, oil formulation, crankcase blow-by, engine operating conditions and ambient temperature.

Hydraulic Oil (HYDO)

The following commercial classifications can be used in the hydraulic system.

- | | |
|---------------------|-----------|
| • ISO 6743/4 | HM |
| • AFNOR NFE 48-603 | HM |
| • DIN 51524 TEIL 2 | H-LP |
| • HAGGLUNDS DENISON | HFO-HF2 |
| • CINCINNATI | P68,69,70 |

Viscosity: ISO VG32

Industrial premium hydraulic oils that have passed the Vickers vane pump test (35VQ25).

These oils should have antiwear, antifoam, antirust and antioxidation additives for heavy duty use as stated by the oil supplier. ISO viscosity grade of 32 would normally be selected.

NOTICE

Make-up oil added to the hydraulic tanks must mix with the oil already in the systems. Use only petroleum products unless the systems are equipped for use with special products. If the hydraulic oil becomes cloudy, water or air is entering the system. Water or air in the system will cause pump failure. Drain the fluid, retighten all hydraulic suction line clamps, purge and refill the system. Consult your DOOSAN Lift Truck dealer for purging instructions.

Drive Axle Oil

NOTE: Do not use Gear Oil in the final drives or differentials. Gear Oil can cause seal material to fail and possibly leak oil.

NOTE: Failure to follow the recommendation will cause shortened life due to excessive gear wear.

The API CD/TO-2 specification or MIL-L-2104D, E or F oils could be used.

NOTE: Multi-grade oils are not blended by DOOSAN for use in transmissions. Multi-grade oils which use high molecular weight polymers as viscosity index improvers lose their viscosity effectiveness by permanent and temporary shear of the viscosity index improver and therefore, are not recommended for transmission and drive train compartments.

Lubricating Grease (MPGM)

Use Multipurpose Molybdenum Grease (MPGM) for all lubrication points. If MPGM grease can not be used, multipurpose type grease which contains 3% to 5% molybdenum disulfide can be used.

NLGI No.2 grade is suitable for most temperatures. Use NLGI No.1 or No.0 grade for extremely low temperature.

Transmission Oil

NOTICE

This oil is formulated for transmissions and drive trains only, and should not be used in engines. Shortened engine life will result.

NOTE: Multi-grade oils are not blended by DOOSAN for use in transmissions. Multi-grade oils which use high molecular weight polymers as viscosity index improvers lose their viscosity effectiveness by permanent and temporary shear of the viscosity index improver and therefore, are not recommended for transmission and drive train compartments.

NOTE: Failure to follow this recommendation can cause shortened transmission life due to material incompatibility, inadequate frictional requirements for disk materials and/or excessive gear wear.

The API CD/TO - 2 specification or MIL - L 2104D, E or F oil could be used.

Brake Fluid

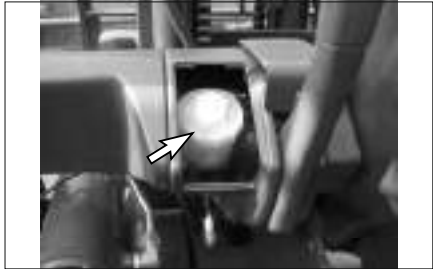

Oil Cooled Disc Brake Only

Use heavy duty hydraulic brake fluid certified by oil supplier to meet the latest version of following classifications.

- ISO 6743/4 HM
- AFNOR NFE 48-603 HM
- DIN 51524 TEIL 2 H-LP
- HAGGLUNDS DENISON HFO-HF2
- CINCINNATI P68,69,70

Viscosity : ISO VG32

Brake reservoir oils that have passed the Vickers vane pump test (35VQ25). These oils should have antiwear, antifoam, antirust and antioxidation additives for heavy duty use as stated by the oil supplier. ISO viscosity grade of 32 would normally be selected.

The following products are authorized for use.

Supplier	Product Name
TOTAL	AZOLLAZS
SHELL	TELLUS
MOBIL	DTE20S'
CALTEX	RANDO HD
ESS	NOTO H
CASTROL	HYSPIN AWS

Lubricant Viscosities and Refill Capacities

Lubricant Viscosities

LUBRICANT VISCOSITIES FOR AMBIENT (OUTSIDE) TEMPERATURES					
Compartment or System	Oil Viscosities	°C		°F	
		Min	Max	Min	Max
G420F(E) Engine Crankcase (Gasoline and LP) API SJ	SAE 10W30	-20	+40	-4	+104
	SAE 5W30	-30	+30	-22	+86
G424F(E) Engine Crankcase (Gasoline and LP) API SJ	SAE 10W30	-20	+40	-4	+104
	SAE 5W30	-30	+30	-22	+86
Engine Crankcase (Diesel) API CH4, ACEA E5	SAE 15W40	-15	+50	-5	+122
Power Shift Transmission & Drive Axle Housing API CD/TO-2	SAE 10W	-20	+22	-4	+72
	SAE 30	+10	+50	+50	+122
Hydraulic and Power Steering System ISO 6743/4 HM	ISO VG 22	-30	+20	-22	+68
	ISO VG 32	-20	+30	-4	+86
	ISO VG 46	-10	+40	+14	+104
	ISO VG 68	0	+50	+32	+122
Brake Reservoir (Only for OCDB) ISO 6743/4HM	ISO VG32	-20	+30	-4	+86

The SAE grade number indicates the viscosity of oil. A proper SAE grade number should be selected according to ambient temperature.

Refill Capacities

REFILL CAPACITIES - (APPROXIMATE)			
Compartment or System		Liters	U.S. Gal.
Engine Crankcase w/Filter G420F & G420F(E) 2.0 liter Gasoline & LP		4.2	1.11
Engine Crankcase w/Filter G424F & G424F(E) 2.4 liter LP		4.5	1.19
Engine Crankcase w/Filter 4TNV98 Diesel		7.6	2.00
Engine Crankcase w/Filter 4TNE98 Diesel		9.2	2.43
Cooling System w/Coolant Recovery Bottle G420F & G420F(E) 2.0 liter Gasoline & LP		8.5	2.25
Cooling System w/Coolant Recovery Bottle G424F & 424F(E) 2.4 liter LP		9.0	2.38
Cooling System w/Coolant Recovery Bottle 4TNV98 & 4TNE98 Diesel		10.7	2.83
Fuel Tank - G, D Series Gasoline or Diesel		51	13.74
Fuel Tank - GC Series Gasoline		40	10.56
LP	G Series	15.2kg	33.5lb
	GC Series	15.2kg	33.5lb
Powershift Transmission	G, D Series	13.0	3.43
	GC Series	11.2	3.0
Drive Axle	G, D Series	9.2	2.43
	GC Series	10.0	2.64
Hydraulic & Power Steering System		34	8.98
Brake Reservoir (Only for OCDB)		1.0	0.3

Maintenance Intervals

NOTICE

All maintenance and repair, except Every 10 Service Hours or Daily, on the lift truck must be performed by qualified and authorized personnel only.

NOTICE

Careless disposal of waste oil can harm the environment and can be dangerous to persons. Always dispose of waste oil to authorized personnel only.

When Required

Fuel Tank Filter Cap and Screen (If Equipped) - Clean	148
Seat, Hood Latch & Support Cylinder - Check, Lubricate.....	148
Fuses, Bulbs, Circuit Breaker & Relay - Change, Reset	149
Priming the Fuel System(Diesel Engine Only)...	150
Water Separator (Diesel Engine Only) - Check, Drain	152
Tires and Wheels (D, G-Series) - Inspect, Check	154
Carriage Roller Extrusion – Adjust	154

Every 10 Service Hours or Daily

Inspect Engine for Fluid Leaks	155
Engine Oil Level - Check	155
Coolant Level – Check	156
Air Cleaner Indicator-Check.....	157
Inspect Foot Pedal Operation (G420F(E)/G424F(E) Only).....	157
Inspect Engine for Exhaust Leaks.....	157
Walk-Around Inspection - Inspect	157
Mast Channels – Lubricate	158
Transmission Oil Level – Check.....	159
Parking Brake - Inspect.....	159

First 50 - 100 Service Hours or a Week

Engine Oil & Filter (Diesel Engine Only) - Change	161
Transmission Oil, Oil Filter & Strainer - Check, Clean, Change.....	162
Drive Axle Oil - Change.....	164
Parking Brake - Test, Adjust.....	164

First 250 Service Hours or a Month

Hydraulic Return Filter – Change	166
--	-----

Every 250 Service Hours or Monthly

Air Intake System - Check, Clean.....	167
Brake Oil Level - Check.....	169
Hydraulic Oil Level – Check.....	169
Drive Axle Oil Level - Check	170
Mast, Carriage, Lift Chains & Attachments - Inspect, Lubricate	170
Steering Mechanism - Check, Lubricate	170
Battery Terminal - Clean, Inspect.....	171
Engine Oil & Filter (LP & Gasoline Engine Only) - Change	171
PCV Valve System - Inspect, Clean.....	172
Wheel Bolts & Nuts - Inspect	173
Inspect Tightness (GC - Series)	173
Governor Lever and Engine Speed Control (Diesel Engine Only) - Check ,Adjust.....	174

Every 500 Service Hours or 3 Months

Belts - Check, Adjust	176
Mast Hinge Pin – Lubricate	176
Tilt Cylinders - Check, Adjust, Lubricate	176
Crosshead Rollers - Inspect.....	177
Transmission Oil Filter – Change	178
Overhead Guard – Inspect.....	178
Drive Axle Oil & Strainer - Change, Clean	179
Steer Suspension – Inspect.....	180
Parking Brake - Test, Adjust	180
Inching & Braking Control Shaft - Lubricate.....	180
Horn and Lights (If Equipped) - Check.....	180
Inspect Vacuum Lines and Fittings (G420F(E)/G424F(E) Engine Only).....	181
Fuel Trim Valve(FTV) Inspection (G420F(E)/G424F(E) Engine Only).....	181
Inspect Electrical System (G420F(E)/G424F(E) Engine Only).....	181
Fuel Filter (Diesel Engine Only) - Change	182
Engine Oil & Filter (Diesel Engine Only) - Change	183
Water Separator (4TNV98 Diesel Engine Only) - Clean.....	184

Every 1000 Service Hours or 6 Months

Hydraulic Return Filter, Breather & Strainer - Check, Change	185
Transmission Oil, Oil Filter & Strainer - Check, Clean, Change	186
Lift Chains - Test, Check, Adjust	186
Universal Joint – Inspect	188
Air Intake System - Change	188

Inspect Coolant Hoses (LP, Dual Fuel Engine Only)	189
LP Regulator/Converter Inspection (LP, Dual Fuel Engine Only)	189
Fuel Lines & Fittings - Check.....	189
Inspect Mixer Assembly (G420F(E)/G424F(E) Engine Only)	189
Inspect Throttle Assembly (G420F(E)/G424F(E) Engine Only)	189
Engine Valve Lash (Diesel Engine Only) - Check, Adjust.....	190

Every 1500 Service Hours or 9 Months

Inspect Ignition System (LP, Gasoline & Dual Fuel Engines Only)	191
Replace Spark Plugs (G424F(E) LP, Dual Fuel Engine Only)	191
Replace LP Fuel Filter Element (LP, Dual Fuel Engine Only)	192
Fuel Filter (LP Engine Only)	192
Testing Fuel Lock-off Operation (LP Engine Only)	192
Fuel Injectors (Diesel Engine Only) – Inspect, Clean, Test.....	193
Crankcase Breather System (4TNV98 Diesel Engine Only) - Inspect.....	193

Every 2000 Service Hours or Yearly

Engine Valve Lash (Diesel Engine Only) – Check, Adjust.....	194
Steer Wheel Bearings - Reassemble.....	194
Drive Wheel Bearing (Power Shaft and Drive Wheel) – Reassemble.....	196
Cooling System – Clean, Change	197
Forks – Inspect.....	199

Every 2500 Service Hours or 15 Months

Hydraulic Oil - Check, Clean, Change	201
Inspect Battery System	201
Replace Oxygen Sensor (G420F(E)/G424F(E) Engine Only)	202
Replace Spark Plugs (G420F(E) Engine Only) ..	202
Checking the TMAP Sensor (G420F(E)/G424F(E) Engine Only)	203
Inspect for Intake Leaks (G420F(E)/G424F(E) Engine Only)	203

Every 3000 Service Hours or 18 Months

Timing Belt [G420F(E)/G424F(E) LP, Gasoline, Dual Fuel Engine Only] - Change.....	204
---	-----

Maintenance Section

Quick Reference to Maintenance Schedule			Maintenance Schedule											
ITEMS	SERVICES	PAGE	FIRST			EVERY								
			When Required	50-100 Service Hours or a Week	250 Service Hours or a Month	10 Service Hours or a Daily	250 Service Hours or a Monthly	500 Service Hours or 3 Months	1000 Service Hours or 6 Months	1500 Service Hours or 9 Months	2000 Service Hours or a Yearly	2500 Service Hours or 15 Months	3000 Service Hours or 18 Months	
Air Cleaner Indicator	Check	157				O								
Air Intake System	Change	188								O				
Air Intake System	Check, Clean	167						O						
Battery Terminal	Clean, Inspect	171						O						
Belts	Check, Adjust	176							O					
Brake Oil Level	Check	169						O						
Carriage Roller Extrusion	Adjust	154	O											
Checking the TMAP Sensor (G420F(E)/G424F(E) Engine Only)		203												O
Coolant Level	Check	156					O							
Cooling System	Clean, Change	197											O	
Crankcase Breather System (4TNV98 Diesel Engine Only)	Inspect	193									O			
Crosshead Rollers	Inspect	177							O					
Drive Axle Oil	Change	164		O										
Drive Axle Oil & Strainer	Change, Clean	179						O						
Drive Axle Oil Level	Check	170						O						
Drive Wheel Bearing (Power Shaft and Drive Wheel)	Reassemble	196											O	
Engine Oil & Filter (Diesel Engine Only)	Change	161, 183		O				O						
Engine Oil & Filter (LP & Gasoline Engine Only)	Change	171					O							
Engine Oil Level	Check	155				O								
Engine Valve Lash (Diesel Engine Only)	Check, Adjust	190, 194							O		O			
Forks	Inspect	199											O	
Fuel Filter (Diesel Engine Only)	Change	182						O						
Fuel Filter (LP Engine Only)		192									O			
Fuel Injectors (Diesel Engine Only)	Inspect, Clean, Test	193									O			
Fuel Lines & Fittings	Check	189								O				
Fuel Tank Filter Cap and Screen (If Equipped)	Clean	148	O											
Fuel Trim Valve(FTV) Inspection (G420F(E)/G424F(E) Engine Only)		181							O					
Fuses, Bulbs, Circuit Breaker & Relay	Change, Reset	149	O											
Governor Lever and Engine Speed Control (Diesel Engine Only)	Check ,Adjust	174						O						
Horn and Lights (If Equipped)	Check	180								O				
Hydraulic Oil	Check, Clean, Change	201												O
Hydraulic Oil Level	Check	169						O						
Hydraulic Return Filter	Change	166		O										
Hydraulic Return Filter, Breather & Strainer	Check, Change	185								O				
Inching & Braking Control Shaft	Lubricate	180								O				
Inspect Battery System		201												O
Inspect Coolant Hoses (LP, Dual Fuel Engine Only)		189								O				
Inspect Electrical System (G420F(E)/G424F(E) Engine Only)		181						O						
Inspect Engine for Exhaust Leaks		157						O						
Inspect Engine for Fluid Leaks		155						O						
Inspect Foot Pedal Operation (G420F(E)/G424F(E) Only)		157						O						
Inspect for Intake Leaks (G420F(E)/G424F(E) Engine Only)		203											O	

Quick Reference to Maintenance Schedule			FIRST		EVERY								
ITEMS	SERVICES	PAGE	When Required	50-100 Service Hours or a Week	250 Service Hours or a Month	10 Service Hours or a Daily	250 Service Hours or a Monthly	500 Service Hours or 3 Months	1000 Service Hours or 6 Months	1500 Service Hours or 9 Months	2000 Service Hours or a Yearly	2500 Service Hours or 15 Months	3000 Service Hours or 18 Months
				Inspect Ignition System (LP, Gasoline & Dual Fuel Engines Only)		191							
Inspect Mixer Assembly (G420F(E)/G424F(E) Engine Only)		189							O				
Inspect Throttle Assembly (G420F(E)/G424F(E) Engine Only)		189							O				
Inspect Tightness (GC - Series)		173					O						
Inspect Vacuum Lines and Fittings (G420F(E)/G424F(E) Engine Only)		181						O					
Lift Chains	Test, Check, Adjust	186							O				
LP Regulator/Converter Inspection (LP, Dual Fuel Engine Only)		189							O				
Mast Channels	Lubricate	158				O							
Mast Hinge Pin	Lubricate	176						O					
Mast, Carriage, Lift Chains & Attachments	Inspect, Lubricate	170					O						
Overhead Guard	Inspect	178						O					
Parking Brake	Inspect	159				O							
Parking Brake	Test, Adjust	164, 180		O				O					
PCV Valve System	Inspect, Clean	172					O						
Priming the Fuel System(Diesel Engine Only)		150	O										
Replace LP Fuel Filter Element (LP, Dual Fuel Engine Only)		192							O				
Replace Oxygen Sensor (G420F(E)/G424F(E) Engine Only)		202										O	
Replace Spark Plugs (G420F(E) Engine Only)		202											O
Replace Spark Plugs (G424F(E) LP, Dual Fuel Engine Only)		191								O			
Seat, Hood Latch & Support Cylinder	Check, Lubricate	148	O										
Steer Suspension	Inspect	180						O					
Steer Wheel Bearings	Reassemble	194										O	
Steering Mechanism	Check, Lubricate	170					O						
Testing Fuel Lock-off Operation (LP Engine Only)		192									O		
Tilt Cylinders	Check, Adjust, Lubricate	176						O					
Timing Belt (G420F(E)/G424F(E) LP, Gasoline, Dual Fuel Engine Only]	Change	204											O
Tires and Wheels (D, G-Series)	Inspect, Check	154	O										
Transmission Oil Filter	Change	178							O				
Transmission Oil Level	Check	159				O							
Transmission Oil, Oil Filter & Strainer	Check, Clean, Change	162, 186		O					O				
Universal Joint	Inspect	188							O				
Walk-Around Inspection	Inspect	157				O							
Water Separator (4TNV98 Diesel Engine Only)	Clean	184							O				
Water Separator (Diesel Engine Only)	Check, Drain	152	O										
Wheel Bolts & Nuts	Inspect	173					O						

When Required

You must read and understand the warnings and instructions contained in the Safety section of this manual, before performing any operation or maintenance procedures.

Fuel Tank Filter Cap and Screen (If Equipped) - Clean

Park the lift truck with the forks lowered, parking brake applied, transmission in neutral and the engine stopped.



1. Remove the filter cap assembly. Clean in clean, nonflammable solvent.
2. Dry cap assembly.
3. Install filter cap assembly.

⚠ WARNING

Fuel leaked or spilled onto hot surfaces or electrical components can cause a fire.

4. Drain moisture and sediment from fuel tank as required by prevailing conditions.

Seat, Hood Latch & Support Cylinder - Check, Lubricate



1. Check the operation of the seat adjuster rod. Make sure that the seat slides freely on its track. Lightly oil the seat slider tracks if necessary.



2. Push the lever down to raise the hood and seat assembly. Make certain the support cylinder will hold the hood open. (Note: Unlock latch before pulling it - if key equipped)



Typical Example

3. Lightly oil the hood latch mechanism and the rod for the hood support cylinder.

Fuses, Bulbs, Circuit Breaker & Relay - Change, Reset

Fuses

NOTE: If a fuse filament separates, use only the same type and size fuses for replacement. If the filament in a new fuse separates, have the circuits and instruments checked.

NOTICE

Always replace fuses with ones of the correct ampere rating.



Typical Example

Check the fuses. Use a flashlight, if necessary.

Fuses are identified as follows:

1. Horn - 10 amps.
2. Head/Rear Lamp - 15 amps.
3. Fwd./Rev. Solenoid, lamp Relay & Back-up Lamp/alarm - 10 amps.
4. Instrument Panel & Fuel Shutoff - 15 amps.
5. Turn Signal Lamp, Stop/Strobe Lamp & C.S.D.
6. Start Relay - 5 amp.

10A	HORN					
15A	OPTION (BAT +)					
15A	HEAD LAMP CLEARANCE LAMP + PARKING ALARM					
15A	ACC					
15	TURN SIG LAMP STOP LAMP, STROBE					
10A	START RELAY					
15A	INST PANEL GONT, GP - FUEL LOCK					
15A	FIR CONTROL LAMP RELAY					
15A	OPTION (IGNITION)					

Check the fuses. Use a flashlight, if necessary.



Remove the front cover from the fuse box located under the cowl.

Fuse - Protects an electrical circuit from an overload. Opens (filament separates) if an overload occurs.

Bulbs

Bulbs are identified as follows:

1. Bulb-head lamp halogen (12V-35W)
- *2. Bulb-back up (12V-10W)
- *3. Bulb-turn signal (12V-23W)
- *4. Bulb-stop & tail (12V-23/8W)

*Optional lamp or light

Circuit Breaker



1. Raise the hood and seat assembly. Make sure the support cylinder securely holds the hood open.



2. The main circuit breaker is located on the rear of the support for the hydraulic controls.

NOTE: To reset circuit breakers push in on the button. The button should stay in if the breaker is reset. If the button will not stay in, or comes out shortly after reset, have the circuits checked.

Priming the Fuel System(Diesel Engine Only)

4TNV98 Diesel Engine Only

The fuel system needs to be primed under certain conditions.

- Before starting the engine for the first time
- After running out of fuel and fuel has been added to the fuel tank
- After fuel system maintenance such as changing the fuel filter and draining the water separator, or replacing a fuel system component.

To prime the fuel system

1. Turn the key to the **ON** position for 10 to 15 seconds. This will allow the electric fuel pump to prime the fuel system.
2. **NEVER** use the starter motor to crank the engine in order to prime the fuel system. This may cause the starter motor to overheat and damage the coils, pinion and ring gear

4TNE98 Diesel Engine Only

The fuel system needs to be primed under certain conditions.

- Before starting the engine for the first time.
- After running out of fuel and fuel has been added to the fuel tank.
- After fuel system maintenance such as changing the fuel filter and draining the fuel filter / water separator, or replacing a fuel system component.

To prime the fuel system on engines equipped with an electric fuel pump:

1. Place an approved container under the air bleed port.
2. Loosen the air bleed port 2 or 3 turns.
3. Turn the key to the ON position for 10 to 15 seconds or until the fuel coming out of the air bleed port is free of bubbles.
4. Tighten the air bleed port.

5. Wipe up any spills and properly dispose of fuel.
6. NEVER use the starter motor to crank the engine in order to prime the fuel system. This may cause the starter motor to overheat and damage the coils, pinion and / or ring gear.

To prime the fuel system on engines not equipped with an electric fuel system:

1. Place an approved container under the air bleed port.
2. Loosen the air bleed port (**Figure 2, (1)**) 2 or 3 turns.
3. Operate the fuel priming pump (**Figure 2, (2)**) until the fuel coming out of the air bleed port is free of bubbles.
4. Tighten the air bleed port.
5. Wipe up any spills and properly dispose of fuel.
6. NEVER use the starter motor to crank the engine in order to prime the fuel system. This may cause the starter motor to overheat and damage the coils, pinion and / or ring gear.

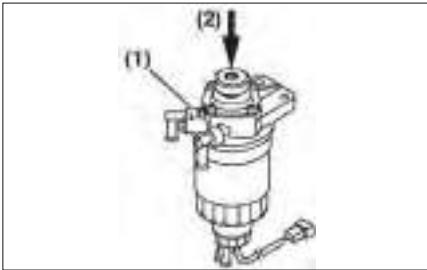

Figure 2

Water Separator (Diesel Engine Only) - Check, Drain

4TNV98 Diesel Engine Only

Drain the fuel filter / water separator whenever there are contaminants, such as water, collected in the bottom of the cup. NEVER wait until the scheduled periodic maintenance if contaminants are discovered.

The cup of the separator is made from semi-transparent material. In the cup is a red colored float ring. The float ring will rise to the surface of the water to show how much needs to be drained. Also, some optional fuel filter / water separators are equipped with a sensor to detect the amount of contaminants. This sensor sends a signal to an indicator to alert the operator.

Drain the fuel filter / water separator as follows:

1. Position an approved container under the fuel filter / water separator (**Figure 5-7, (1)**) to collect the contaminants.

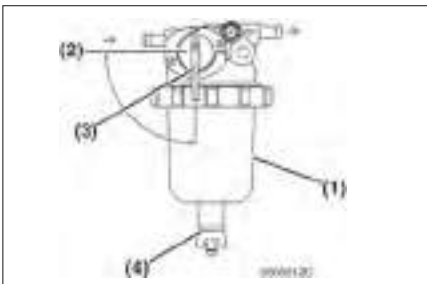

Figure 5-7

2. Close (**Figure 5-7, (2)**) the fuel cock (**Figure 5-7, (3)**).
3. Loosen the drain cock (**Figure 5-7, (4)**) at the bottom of the fuel filter / water separator. Drain any water collected inside.
4. Hand-tighten the drain cock.

WARNING

If the fuel filter/water separator is positioned higher than the fuel level in the fuel tank, water may not drip out when the fuel filter/water separator drain cock is opened. If this happens, turn the air vent screw on the top of the fuel filter/water separator 2-3 turns counterclockwise.

Be sure to tighten the air vent screw after the water has drained out.

5. Open the fuel cock (**Figure 5-7, (3)**).
6. Be sure to prime the diesel fuel system when you are finished. See topic "Priming the Fuel System – When required"
7. Check for leaks.

4TNE98 Diesel Engine Only

NEVER wait until the scheduled periodic maintenance if the fuel filter indicator comes on.

The fuel filter / water separator contains a sensor to detect the amount of water and contaminants. This sensor sends a signal to an indicator to alert the operator.

Drain the fuel filter / water separator as follows:

1. Position an approved container under the fuel filter / water separator (**Figure 5-1, (1)**) to collect the contaminants.
2. Loosen the drain cock (**Figure 5-1, (2)**) at the bottom of the fuel filter / water separator. Drain any water collected inside.
3. Hand tighten the drain cock.
4. Be sure to prime the diesel fuel system when you are done. See Priming the Fuel System.



Figure 5-1

Test Fuel System for Leaks(LP and Dual Fuel Engines Only)

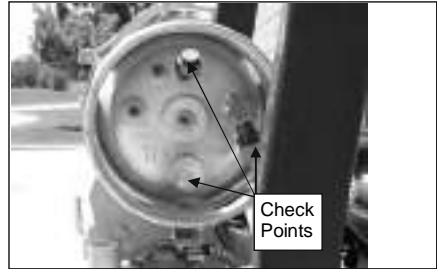

1. Obtain a leak check squirt bottle or pump spray bottle.
2. Fill the bottle with an approved leak check solution.
3. Spray a generous amount of the solution on the fuel system fuel lines and connections, starting at the storage container.
4. Wait approximately 15-60 seconds then perform a visual inspection of the fuel system. Leaks will cause the solution to bubble.
5. Repair any leaks before continuing.
6. Crank the engine through several revolutions. This will energize the fuel lock-off and allow fuel to flow to the pressure regulator/convertor. Apply additional leak check solution to the regulator/convertor fuel connections and housing. Repeat leak inspection as listed above.
7. Repair any fuel leaks before continuing.

WARNING

Prior to any service or maintenance activity, Test Fuel System for Leaks.

Tires and Wheels (D, G-Series) - Inspect, Check

WARNING

Service and changing tires and rims can be dangerous and should be done only by trained personnel using proper tools and procedures. If correct procedures are not followed while servicing tires and rims, the assemblies could burst with explosive force and cause serious physical injury or death. Follow carefully the specific information provided by your tire servicing man or dealer.

Check Inflation and Damage

Inspect tires for wear, cuts, gouges and foreign objects. Look for bent rims and correct seating of locking ring.

Check tires for proper inflation. See "Tire Inflation Pressures".

To inflate tires always use a clip-on chuck with a minimum 60 cm (24 inches) length of hose to an in-line valve and gauge.

Always stand behind the tread of the tire. NOT in front of the rim.



Do not re-inflate a tire that has been run while flat or underinflated, without first checking to make sure the locking ring on the rim is not damaged and is in the correct position.

When tires are changed, be sure to clean all rim parts and, if necessary, repaint to stop detrimental effects of corrosion. Sand blasting is recommended for removal of rust.

Check all components carefully and replace any cracked, badly worn, damaged and severely rusted or corroded parts with new parts of the same size and type. If there is any doubt, replace with new parts.

Do not, under any circumstances, attempt to rework, weld, heat or braze any rim components.

Carriage Roller Extrusion – Adjust

1. Set the mast vertical.
2. Lower the carriage completely.
3. On full free lift and full free triple lift models, the bottom of the inner mast must be flush with the bottom of the stationary mast.

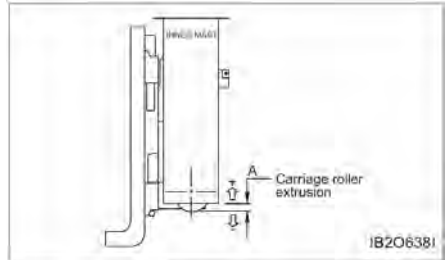

4. Measure the distance from the bottom of the inner upright to the bottom of carriage bearing.
5. The measurement (A) must be as follows in Chart below.

Height of carriage roller extrusion (A)		
STD mast	FF mast	FFT mast
0	41	41

Every 10 Service Hours or Daily

You must read and understand the warnings and instructions contained in the Safety section of this manual, before performing any operation or maintenance procedures.

Inspect Engine for Fluid Leaks

1. Start the engine and allow it to reach operating temperatures.
2. Turn the engine off.
3. Inspect the entire for oil and/or coolant leaks.
4. Repair as necessary before continuing.

Engine Oil Level - Check

1. Raise the hood and seat assembly.

⚠ WARNING

Hot oil and components can cause personal injury. Do not allow hot oil or components to contact skin.

Gasoline and LP Engines

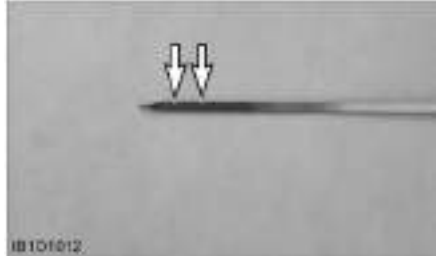

1. Maintain oil level between the MAX. and MIN. marks on the dipstick.

Diesel Engines



1. Maintain oil level between the MAX. and MIN. marks on the dipstick.

Coolant Level – Check

⚠ WARNING

At operating temperature, the engine coolant is hot and under pressure.

Steam can cause personal injury.

Check the coolant level only after the engine has been stopped and the filter cap is cool enough to touch with your bare hand.

Remove the filter cap slowly to relieve pressure.

Cooling system conditioner contains alkali. Avoid contact with the skin and eyes to prevent personal

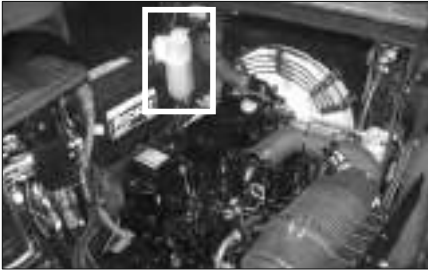

4TNV98 Diesel Engine

1. Observe the coolant level with engine cold. Maintain coolant level to the proper line on expansion bottle. If the expansion bottle has no coolant, it will be necessary to check coolant at the radiator filter neck.
2. Remove the radiator cap. Fill radiator to the top of the filter neck. Inspect radiator cap. Replace if damaged. Install the radiator cap.



3. Start and run the engine to stabilize the coolant level in the filter neck. If low, add coolant until it reaches the top of the filter neck. Install the radiator cap. Observe coolant level in the expansion bottle. If necessary, add coolant to bring the coolant to the appropriate line on the expansion bottle.
4. Stop the engine.
5. Inspect the cooling system for leaks, hose cracks or loose connections.

⚠ WARNING

Pressure air can cause personal injury.

When using pressure air for cleaning, wear a protective face shield, protective clothing and protective shoes.

Maximum air pressure must be less than 205 kPa (30 psi) for cleaning purposes.

6. Blow any dust and lint from the radiator fins.

Air Cleaner Indicator-Check

Checking Service Indicator



1. Observe the air cleaner service indicator.
2. Service the air cleaner when the RED band in the service indicator, locks in the visible position. See topic, "Air Intake System - Check, Clean" in "Every 250 Service Hours or Monthly".

NOTE: Service the element more frequently, as required, in severe dust or lint conditions. Also, service it more frequently where the operator is required to wear a respirator.

3. Close hood and seat assembly.

Inspect Foot Pedal Operation (G420F(E)/G424F(E) Only)

1. Verify foot pedal travel is smooth without sticking.

WARNING

When the acceleration pedal harness is connected or disconnected, should be worked key OFF condition.

If not, occurred malfunction, can cause the personal injury.

Inspect Engine for Exhaust Leaks

1. Start the engine and allow it to reach operating temperatures.
2. Perform visual inspection of exhaust system. Repair any/all leaks found.

Walk-Around Inspection - Inspect

For maximum service life of the lift truck, make a thorough walk-around inspection. Look around and under the truck for such items as loose or missing bolts, debris or dirt buildup, fuel, oil or coolant leaks and cut or gouged tires.

Have any repairs made and debris removed, as needed.



1. Inspect the tires and wheels for cuts, gouges, foreign objects, inflation pressure and loose or missing bolts.
2. Inspect the mast and lift chains for wear, broken links, pins and loose rollers.
3. Inspect the hydraulic system for leaks, worn hoses or damaged lines.
4. Look for transmission and drive axle leaks on the lift truck and on the ground.



5. Inspect the operator's compartment for loose items and cleanliness.
6. Inspect the instrument panel for broken gauges and indicator lights.
7. Test the horn and other safety devices for proper operation.



8. Inspect the cooling system for leaks, worn hoses and debris buildup.
9. Inspect engine compartment for oil, coolant and fuel leaks.
10. Inspect the forks.
 - Visually inspect forks for cracks, especially in the heel section, around the mounting brackets, and all weld areas.
 - Inspect for broken or jagged fork tips, bent or twisted blades and shanks.
 - Make sure positioning lock is in place and working.
Lock the forks in position before using the truck. See Step 7 of "Forks" in "Every 2000 Service Hours or Yearly".
 - Remove all defective forks from service.

Mast Channels – Lubricate



The channels on the roller-type mast require a break-in period. Apply a light film of lubricant on the channels where the rollers ride. This will prevent metal peel until the rollers set a pattern.

Transmission Oil Level – Check

WARNING

Hot oil and components can cause personal injury. Do not allow hot oil or components to contact skin.

1. Start and operate the lift truck until the engine reaches normal operating temperature.
2. Park the lift truck level with the forks lowered, parking brake applied and the transmission controls in NEUTRAL.
3. With the service brake applied and the engine at low idle, shift the directional control lever to forward and then to reverse, to fill the clutches.
4. Shift the direction control lever to the NEUTRAL position.
5. Remove the dip stick/filter cap. Observe the oil level.
6. Maintain the oil level between the Min and Max marks on the dip stick/filter cap.
When the oil temperature is 40°C approximately, the cold side mark on the dipstick is applicable.
When the oil temperature is 80°C approximately, the hot side mark on the dipstick is applicable.



Parking Brake - Inspect

Inspection from Operator's Seat, Engine OFF

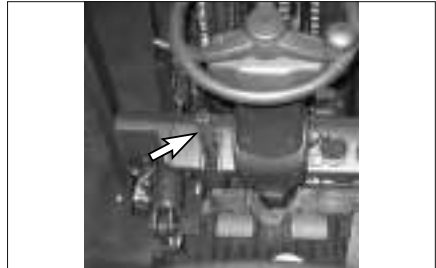

1. Grasp the parking brake lever with your hand and press down the release button with your thumb. The lever should move freely forward and backward.
2. Remove your thumb from the release button. The lever should resist movement when pulled fully back and a clicking sound should be heard. The lever should remain fully back until you press the release button with your thumb.
3. Report a missing, damaged or loose parking brake lever, any inability or difficulty engaging and releasing the parking brake lever, or any restricted movement of the parking brake lever.

Inspection from Operator's Seat, Engine ON

PARKING BRAKE SWITCH

1. With the parking brake engaged, the direction control lever in NEUTRAL and the engine running, shift the direction control lever to FORWARD.
2. The lift truck should not move forward or feel like it wants to move forward, even when the engine is accelerated briefly.
3. Repeat this procedure in REVERSE. Report truck movement or tendency to move under power with the parking brake engaged.

PARKING BRAKE

NOTE: The parking brake is required to be adjusted to hold the lift truck with capacity load on a 15% grade.

If there is a 15% grade in your workplace, engage a capacity load and drive over to the grade. If the maximum grade in your workplace is less than 15% or if the maximum load carried by the lift truck is less than the lift truck's load capacity, pick up the maximum load and drive to the steepest grade in your workplace.

1. Raise the forks or load engaging attachment about 30 cm (12 in) from the floor.
2. Drive forward up the grade, or in reverse down the grade, and stop the lift truck with the service brakes.
3. Engage the parking brake and release the service brakes.
4. If the lift truck moves down the grade, control its speed with the service brakes, release the parking brake and return directly to the inspection area.
5. Park the lift truck, engage the parking brake, shift the direction control lever to NEUTRAL, lower the forks or load engaging attachment to the floor, shut OFF the engine, remove the key, chock the tires, terminate the inspection, tag the lift truck "Do Not Operate" and immediately report the failure of the parking brake to hold the lift truck.

First 50 - 100 Service Hours or a Week

You must read and understand the warnings and instructions contained in the Safety section of this manual, before performing any operation or maintenance procedures.

Engine Oil & Filter (Diesel Engine Only) - Change

The engine oil in a new engine becomes contaminated from the initial break-in of internal parts. It is very important that the initial oil and filter change is performed as scheduled.

NOTE: The oil drain plug may be in another location if an optional oil pan is used..

Drain the engine oil as follows:

1. Make sure the engine is level.
2. Start the engine and bring it up to operating temperature.
3. Stop the engine.
4. Remove one of the oil filler caps (**Figure 5-1, (1)**) to vent the engine crankcase and allow the engine oil to drain more easily.
5. Position a container under the engine to collect waste oil.

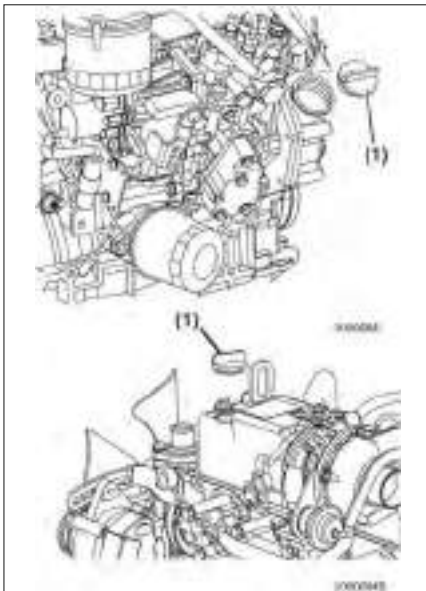

Figure 5-1

6. Remove the oil drain plug (**Figure 5-2, (1)**) from the engine oil pan. Allow oil to drain.
7. After all oil has been drained from the engine, reinstall the oil drain plug (**Figure 5-2, (1)**) and tighten to 139.8 - 47.0 ft•lb (53.9 - 63.7 N•m; 5.5 - 6.5 kgf•m).
8. Dispose of used oil properly.

Remove the engine oil filter as follows:

1. Turn the engine oil filter (**Figure 5-2, (2)**) counterclockwise (**Figure 5-2, (3)**) using a filter wrench.

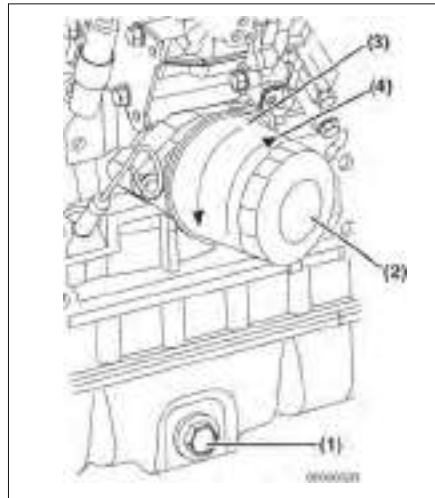

Figure 5-2

2. Clean the engine oil filter mounting face.
3. Lightly coat the gasket on the new oil filter with engine oil. Install the new engine oil filter manually by turning it clockwise (**Figure 5-2, (4)**) until it contacts the mounting surface. Tighten to 14 - 17 ft•lb (19.6 - 23.5 N•m; 2.0 - 2.4 kgf•m) or one additional turn using the filter wrench.
4. Add new engine oil to the engine as specified in Adding Engine Oil on page 4-14.

⚠ WARNING

NEVER overfill the engine with engine oil.

ALWAYS keep the oil level between the upper and lower lines on the oil cap/dipstick.

- Warm up the engine by running it for five minutes and check for any engine oil leaks.
- After engine is warm, shut it off and let it sit for 10 minutes.
- Recheck the engine oil level.
- Add engine oil (**Figure 5-3, (5)**) as needed until the level is between the upper (**Figure 5-3, (2)**) and lower lines (**Figure 5-3, (3)**) shown on the dipstick (**Figure 5-3, (1)**).

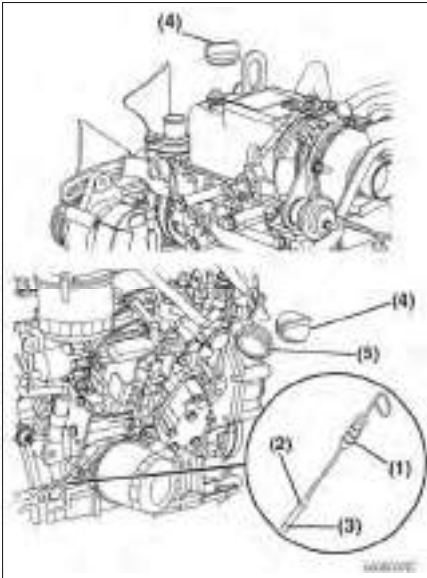

Figure 5-3

- Reinstall the oil filler cap (**Figure 5-3, (4)**). If any engine oil is spilled, wipe it away with a clean cloth.

NOTICE

Servicing of the engine oil and oil filter element will largely affect the engine performance as well as the engine life. Engine oil and filter element must be changed after the first 50 hours.

Transmission Oil, Oil Filter & Strainer - Check, Clean, Change

⚠ WARNING

Hot oil and components can cause personal injury. Do not allow hot oil or components to contact skin.

Park the lift truck level, with the forks lowered, parking brake engaged, direction control lever in NEUTRAL and the engine stopped.

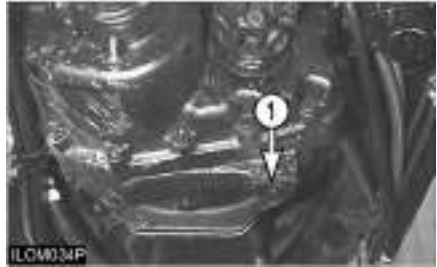

- Remove drain plug (1). Allow the oil to drain into a suitable container. Clean the magnetic drain plug. Check O-ring seal and replace if necessary. Remove the spring and the strainer.

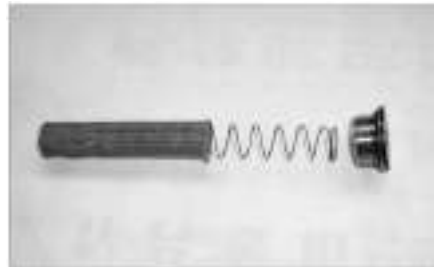

- Wash the strainer assembly in clean, nonflammable solvent and dry it. Install the strainer assembly.



3. Remove the floor mat and the floor plate.
Remove and discard the oil filter.
4. Wipe off the filter base. Make certain that all of the old seal is removed.
5. Apply a small amount of clean oil on the seal of the new filter.
6. Install the filter by hand. When the filter contacts the base, tighten an additional 3/4 turn.



7. Remove the dip stick/filter cap. Fill the compartment with oil. See "Refill Capacities".
Install the dip stick/filter cap.
8. Start the engine.
9. With the service brake applied and engine at low idle, shift the direction control lever to forward and reverse to fill the clutches.
10. Shift the direction control lever into NEUTRAL.
Engage the parking brake.
11. Remove the dip stick/filter cap. Observe the oil level.

12. Maintain the oil level between the Min and Max marks on the dip stick/filter cap.
When the oil temperature is 40°C approximately, the cold side mark on the dipstick is applicable.
When the oil temperature is 80°C approximately, the hot side mark on the dipstick is applicable.
13. Check for oil leaks at the filters and drain plug.
14. Stop the engine. Install the floor mat and floor plate.

Drive Axle Oil - Change

Park the lift truck on a level surface. Apply the parking brake. Place the directional control lever in NEUTRAL and stop the engine.



1. Remove drain plug. Allow the oil to drain into a suitable container. Clean the magnetic drain plug. Check O - ring seal and replace if necessary.
2. Install the drain plug.
3. Remove the dip stick/filter cap. Fill the drive axle housing with oil. See "Refill Capacities".
4. Start the lift truck. With the engine at low idle, place the directional control lever to the NEUTRAL.
5. Maintain the oil level between lower mark and upper mark on the dip stick/filter cap.



6. Install the dip stick/filter cap.

NOTE: Tighten the dipstick plug fully not to allow foreign parts(rain, water etc) to enter into drive axle.

Parking Brake - Test, Adjust

Parking Brake Testing

NOTICE

OSHA requires the parking brake to hold the lift truck, with capacity load, on a 15% grade. Testing requires a test load equal to the capacity of the truck and a 15% grade. If the maximum grade in the workplace is less than its capacity, use the Parking Brake inspection procedure covered in 'Inspection from Operator's Seat, Engine On' in "Every 10 Service Hours or Daily" section.

1. Pick up capacity load and drive over to a 15% grade.
2. Drive forward up the 15% grade. Halfway up the grade, stop the lift truck with its service brakes.
3. Engage the parking brake and slowly release the service brake.

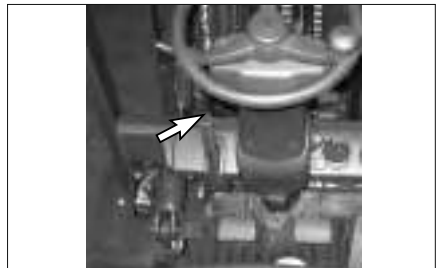

4. Engage the parking brake and shift the transmission to NEUTRAL. Slowly release the service brakes.
5. The parking brake adjustment is proper if it holds the lift truck on the grade. The parking brake needs adjusting if it does not hold the lift truck on the grade.
6. If the lift truck starts to move in reverse down the grade with the parking brake engaged, stop it with the service brakes, disengage the parking brake and reverse slowly down the grade controlling your speed with the service brakes.

WARNING

To prevent personal injury, the operator **MUST** be ready to use the service brake if the parking brake is not adjusted correctly and the lift truck starts to move.

Parking Brake Adjusting

1. Park the lift truck on a level surface, lowered the forks, shift the transmission to NEUTRAL and shut OFF the engine and block the wheels securely.
2. Chock the lift truck's tires to prevent unintentional movement.

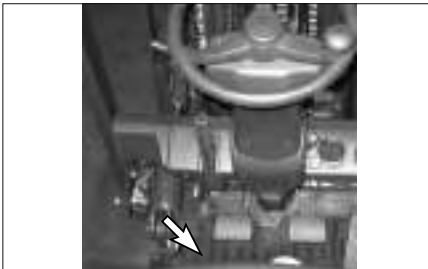

3. Remove the floor mat and floor plate.
4. Make sure the parking brake lever is released.

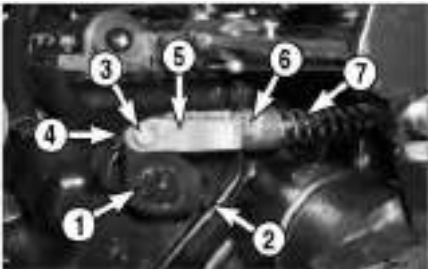

5. Make sure the brake lever (1) is held against stop pin (2). If the brake lever (1) is held against the stop pin (2), go to step 7. If the brake lever (1) is NOT held against the stop pin (2), go to step 6.
6. Remove the pin (3) and the cotter pin (4). Tighten the nut (6) to compress the spring (7) further and pull downward and turn the clevis (5) until the pin (3) fits into the brake lever when the lever (1) is held against the stop pin (2). Then install the pin (3) and the cotter pin (4) and return the nut (6) to the clevis (5).



7. Loosen lock nut (5). Tighten screw (6) to 6 to 7 N•m (50 to 60 lb•in). Loosen the screw (6) 1 1/6 turns and tighten the lock nut (5).

NOTICE

Turn the adjustment screw (6) clockwise to tighten. Turning the screw (6) too far counterclockwise could allow parts to fall into the bottom of the transmission. The transmission would then require disassembly to remove the parts.

8. Reinstall the floor plate and floor mat.
9. Engage the parking brake, remove the tire chocks and test the parking brake. Refer to 'Parking Brake Testing' in the preceding section.

First 250 Service Hours or a Month

You must read and understand the warnings and instructions contained in the Safety section of this manual, before performing any operation or maintenance procedures.

Hydraulic Return Filter – Change

⚠ WARNING

Hot oil and components can cause personal injury. Do not allow hot oil or components to contact skin.

Park the lift truck level with the forks lowered, parking brake engaged, transmission in NEUTRAL and the engine stopped.

1. Loosen the bolts of the hydraulic tank top plate assembly.



2. Remove the return filter from tank top plate assembly.
3. Change the return filter.
4. Install the tank top plate assembly and fasten the bolts.
5. Start the engine and operate the hydraulic controls, and the steering system, through a few cycles to fill the lines. Look for oil leaks.
6. Stop the engine and check the oil level. With all cylinders retracted, maintain the oil level to the FULL mark on the dip stick/filter cap assembly.

Every 250 Service Hours or Monthly

You must read and understand the warnings and instructions contained in the Safety section of this manual, before performing any operation or maintenance procedures.

Air Intake System - Check, Clean Precleaner (If Equipped)

NOTICE

Never service precleaner with the engine running.



1. Check the precleaner bowl for dirt build-up. If the dirt is up to the line, remove the precleaner bowl and empty it. Periodically wash the cover and bowl in water.

Servicing Filter Element

NOTICE

Never service filter with the engine running.



Service the air cleaner when the red target in the service indicator stays locked in the visible position with the engine stopped.

1. To service the air cleaner, raise the hood and seat assembly. Make certain the support cylinder securely holds the hood open. Loosen the cover latches and remove the cover.



2. Rotate the element slightly to separate it from its base and remove it from the air cleaner housing.
3. Clean and inspect the element or replace with a new element. See topic, "Cleaning Primary Filter Element".
4. Clean the inside of air cleaner housing and the cover. Inspect all connections between the air cleaner and carburetor. Check intake hose for cracks, damage necessary to prevent leakage.

NOTICE

Do not allow dirty air to enter the intake hose when cleaning the inside of the air cleaner housing.

5. Check the air cleaner housing for loose latches.
6. Reset the air cleaner service indicator.
7. Install the air filter element.
8. Install the cover and tighten the cover latches.
9. Start the engine and observe the position of the indicator. If the indicator shows RED after the installation of the primary element, install another clean or a new element or, replace the secondary element. See topic, "Air Intake System-Change" in "Every 1000 Service Hours or 6 months section"
10. Stop the engine and close the hood and seat assembly.

Cleaning Primary Filter Elements

WARNING

Pressure air can cause personal injury.

When using pressure air for cleaning, wear a protective face shield, protective clothing and protective shoes.

The maximum air pressure must be below 205 kPa (30 psi) for cleaning purposes.

NOTICE

Do not clean the elements by bumping or tapping them.

Inspect filter elements after cleaning. Do not use a filter with damaged pleats, gaskets or seals.

When cleaning with pressure air, use 205 kPa (30 psi) maximum pressure to prevent filter element damage.

When cleaning with pressure water, use 280 kPa (40 psi) maximum pressure to prevent filter element damage.

Have spare elements on hand to use while cleaning used elements.

The primary element should be replaced after 6 months service or after cleaning no more than 3 times.

Air-205 kPa (30 psi) Maximum Pressure



Direct air on the inside and outside of the element along the length of the pleats. Check the element for any tears, rips or damage

Water-280kPa (40 psi) Maximum Pressure



Direct water on the inside and outside of the element along the length of the pleats. Air dry it thoroughly and then examine it.

Detergent

1. Wash the element in warm water and mild household detergent.
2. Rinse the element with clean water. See instructions in preceding topic for cleaning with water.
3. Air dry it thoroughly, and then examine it.

Checking Element



1. Insert a light inside the clean dry element and examine it. Discard the element if tears, rips or damage are found.
2. Wrap and store good elements in a clean, dry place.

Brake Oil Level - Check



The brake reservoir is located on the left side of the steering column.

1. Remove the filler cap.
2. Maintain the brake fluid level to the fluid level mark on the brake system reservoir.
3. Clean and install the filler cap

Hydraulic Oil Level – Check

WARNING

At operating temperature, the hydraulic tank is hot and under pressure.

Hot oil can cause burns.

Remove the filter cap only when the engine is stopped, and the cap is cool enough to touch with your bare hand. Remove the filter cap slowly to relieve pressure.

1. Operate the lift truck for a few minutes to warm the oil. Park the lift truck on a level surface, with the forks lowered, mast tilted back, parking brake engaged, transmission in NEUTRAL and the engine stopped.
2. Raise the hood and seat assembly. Make sure the air lift cylinder securely holds the hood open.



3. Remove the dip stick/filter cap. Maintain the oil level to the FULL mark on the dip stick/filter cap.

Drive Axle Oil Level - Check

Park the lift truck on a level surface. Apply the parking brake. The engine at low idle. Place the directional control lever in NEUTRAL.



1. Remove the dip stick/filter cap. Observe the oil level.
2. Maintain the oil level between the lower mark and upper marks on the dip stick/filter cap.

Mast, Carriage, Lift Chains & Attachments - Inspect, Lubricate

1. Operate the lift, tilt and attachment controls. Listen for unusual noises. These may indicate a need for repair.
2. Inspect for loose bolts and nuts on the carriage. Remove any debris from the carriage and mast.
3. Inspect the forks and attachments for free operation and damage. Have repairs made if necessary.



4. Brush a film of oil on all links of the chain.

5. Raise and lower the carriage a few times to allow lubricant to enter into the chain links.

NOTICE

Lubricate chains more frequently than normal in applications where the lift truck is operating in an atmosphere which could cause corrosion of components or when lift truck must work in rapid lift cycles.

6. Inspect the chain anchors and individual links for wear, loose pins or cracked leaves.

Steering Mechanism - Check, Lubricate



1. Lubricate the steer axle king pins, total of four fittings. Two on the right side and two on the left side.
2. Lubricate the steering link bearings, total of four fittings. Two on the right side and two on the left side.
3. Check for any worn or loose components of the steering mechanism. Remove any debris or trash as

Battery Terminal - Clean, Inspect

WARNING

Batteries give off flammable fumes that can explode.

Do not smoke when observing the battery electrolyte levels.

Electrolyte is an acid and can cause personal injury if it contacts skin or eyes.

Always wear protective glasses when working with batteries.



1. Clean the top of the battery and terminals.
2. Check terminals for corrosion. Coat terminals with heavy grease.

Engine Oil & Filter (LP & Gasoline Engine Only) - Change

Gasoline, LP Engine Crankcase

1. Operate lift truck a few minutes to warm oil. Park the lift truck with the forks lowered, parking brake applied, transmission in neutral and the engine stopped.
2. Raise rear of lift truck off ground and block securely.

WARNING

Hot oil and components can cause personal injury. Do not allow hot oil or components to contact skin.



3. Remove the crankcase drain plug and allow oil to drain into a suitable container. Clean and install drain plug.
4. Raise the hood and seat assembly.



5. Remove and discard oil filter element.
6. Wipe sealing surface of oil filter element mounting base. Make sure the entire old gasket is removed.

7. Before installing a new filter element, apply a small amount of clean engine oil to the filter element gasket.
8. Install the new filter element. When the gasket contacts the base, tighten it 3/4 of a turn more. Do not over-tighten.
9. Raise the lift truck, remove the blocking and lower the lift truck.
10. Fill the crankcase. See "Refill Capacities".
11. Start the engine and allow the oil to fill the filter and passages.
12. Check for oil leaks.



13. Stop the engine and measure the oil level. Maintain the oil level to the FULL mark on the dip stick.
14. Close hood and seat assembly

PCV Valve System - Inspect, Clean

G420F(E) Gasoline, LP and Dual Fuel Engines



G424F(E) LP and Dual Fuel Engines

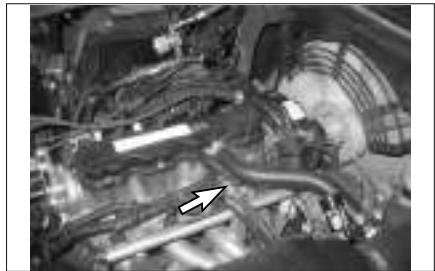

1. Loosen the hose clamps and remove the PCV valve.
2. Shake the PCV valve. If it rattles, reinstall it. If it does not rattle, replace it.
3. Tighten the hose clamps

Wheel Bolts & Nuts - Inspect Inspect Tightness (D, G - Series)

Steer Wheels



Typical Example

1. Inspect tightness of wheel bolts in a sequence opposite each other 110 N•m (75 lb•ft).

Drive Wheels



Typical Example

2. Inspect tightness of wheel nuts in a sequence opposite each other to 610 N•m (450 lb•ft).

Inspect Tightness (GC - Series)

Drive Wheels



Typical Example

1. Inspect tightness of wheel bolts in a sequence opposite each other to 245 N•m (180 lb•ft).

Governor Lever and Engine Speed Control (Diesel Engine Only) - Check, Adjust

4TNV98 Diesel Engine Only

The governor lever and engine speed control (throttle lever, pedal, etc.) of the machine are connected together by a throttle cable or rod. If the cable becomes stretched, or the connections loosen, the governor lever may not respond to change of engine speed control position. This may make operation of the machine unsafe. Check the cable periodically and adjust if necessary.

NEVER force the throttle cable or pedal to move. This may deform the governor lever or stretch the cable and cause irregular operation of the engine speed control

Checking and adjusting the governor lever:

1. Check that the governor lever (**Figure 5-11, (1)**) makes uniform contact with the high idle (**Figure 5-11, (2)**) and low idle (**Figure 5-11, (3)**) speed limit screws when the engine speed control is in the high idle speed or low idle speed position.

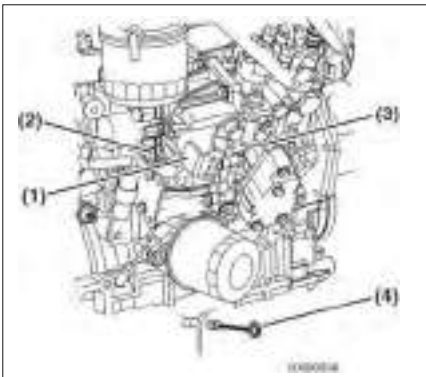

Figure 5-11

2. If the governor lever does not make contact with the high idle or low idle speed limit screw, adjust the throttle cable.
3. In some engine speed control applications, loosen the throttle cable lock nut (**Figure 5-11, (4)**) and adjust the cable so the governor lever makes proper contact with the high / low idle speed limit screw

WARNING

NEVER attempt to adjust the low or high idle speed limit screw. This may impair the safety and performance of the machine and shorten its life. If the idle speed limit screws require adjustment, see your authorized Yanmar industrial engine dealer or distributor..

4TNE98 Diesel Engine Only

The governor lever and engine speed control(accelerator lever, pedal, etc.) of the machine are connected together by an accelerator cable or rod. If the cable becomes stretched, or the connections loosen, the governor lever may not respond to change of engine speed control position. This may make operation of the machine unsafe. Check the cable periodically and adjust if necessary. Consult your authorized Yanmar industrial engine dealer or distributor for the adjustment procedure.

NEVER force the accelerator cable or pedal to move. This may deform the governor lever or stretch the cable and cause irregular operation of the engine speed control.

Checking and adjusting the governor lever:

1. Check that the governor lever (**Figure 5-12, (1)**) makes uniform contact with the low idle (**Figure 5-12, (2)**) and high idle (**Figure 5-12, (3)**) speed limit screws when the engine speed control is in the high idle speed or low idle speed position.
2. If the governor lever does not make contact with the high idle or low idle speed limit screw, adjust the accelerator cable.
3. In some engine speed control applications, loosen the accelerator cable locknut and adjust the cable so the governor lever makes proper contact with the high / low idle speed limit screw.

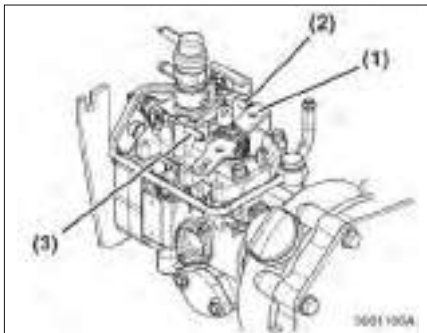
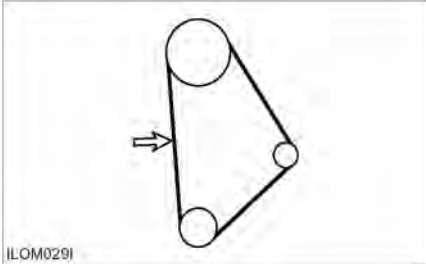

Figure 5-12

Every 500 Service Hours or 3 Months

You must read and understand the warnings and instructions contained in the Safety section of this manual, before performing any operation or maintenance procedures.

Belts - Check, Adjust



Typical Example

1. Check the condition and adjustment of the belt. Correct adjustment allows 10 mm (3/8 inch) deflection under 110 N (25 lb) of force.



NOTICE

Failure to loosen the alternator mounting bolt (2) will cause excessive stress and break the alternator mounting ear.

2. To adjust the alternator drive belt, loosen adjusting bracket bolt (1) and mounting bolt (2). Move the alternator in or out as required. Tighten bolts (1) and (2).

Mast Hinge Pin – Lubricate



Typical Example

1. Lower the forks and tilt the mast forward.
2. Lubricate the two fittings for the mast hinge pins, one on each side of the mast.

Tilt Cylinders - Check, Adjust, Lubricate

Chassis Pivot Eyebolts-Lubricate



Typical Example

1. Remove floor plates. (GC-series only)
2. Lubricate two fittings for the pivot eyebolts, one on each tilt cylinder.
3. Check the pivot eye pins for loose retainer bolts and wear.

Mast Pivot Eyes-Lubricate



Typical Example

1. Lubricate two fittings for the mast pivot eyes, one on each side of the pin.
2. Check the pivot eye pins for loose retainer bolts and wear.

Cylinder Rod Extension-Adjust

NOTE: The following description is for forward tilt. For cylinder rod back tilt, the collar should be stationary by the tilt eye. If it is not, the O-ring inside the collar may need to be replaced. To adjust back tilt, spacers must be added or removed.



Typical Example

1. Check to make sure the tilt cylinders extend and retract evenly.
2. If one cylinder continues to move after the other cylinder has stopped in full forward or backward tilt, an adjustment must be made to one cylinder.



Typical Example

3. To adjust the cylinder rod extension, move the spacer to the rear and loosen the pinch bolt on the clevis.
4. Turn the cylinder rod in or out of the clevis to obtain the proper adjustment. Turning the rod into the clevis shortens the stroke. Turning the rod out of the clevis lengthens the stroke.
5. Tighten the pinch bolts to a torque of 95 ± 15 Name (70 ± 10 abaf). Check the cylinder rods again for even travel.

Crosshead Rollers - Inspect

Check Operation

1. Operate the mast through a lift cycle. Watch the chains move over the crosshead rollers. Make sure the chain is tracking over the rollers properly.



Typical Example

2. Check for damaged crosshead rollers, guards and retainer rings.

Transmission Oil Filter – Change

WARNING

Hot oil and components can cause personal injury. Do not allow hot oil or components to contact skin.

Park the lift truck level, with the forks lowered, parking brake engaged, direction control lever in NEUTRAL and the engine stopped.



1. Remove the floor mat and the floor plate. Remove and discard the oil filter.
2. Wipe off the filter base. Make certain that all of the old seal is removed.
3. Apply a small amount of clean oil on the seal of the new filter.
4. Install the filter by hand. When the filter contacts the base, tighten an additional 3/4 turn.
5. Start the engine.
6. With the service brake applied and engine at low idle, shift the direction control lever to forward and reverse to fill the clutches.
7. Shift the direction control lever into NEUTRAL. Engage the parking brake.
8. Remove the dip stick/filter cap. Observe the oil level.
9. Maintain the oil level between the Min and Max marks on the dip stick/filter cap. When the oil temperature is 40°C approximately, the cold side mark on the dipstick is applicable. When the oil temperature is 80°C approximately, the hot side mark on the dipstick is applicable.
10. Check for oil leaks at the filters.
11. Stop the engine. Install the floor mat and floor plate.

Overhead Guard – Inspect



1. Check tightness of overhead guard mounting bolts at 95 N•m (70 lb•ft).
2. Check overhead guard for bent or cracked sections. Have repairs made if needed.

Drive Axle Oil & Strainer - Change, Clean

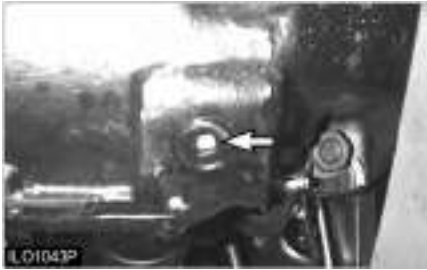

7. Install the dip stick/filter cap.

Park the lift truck level, with the forks lowered, parking brake engaged, transmission in NEUTRAL and engine stopped.

1. Remove drain plug. Allow the oil to drain into a suitable container. Clean the magnetic drain plug. Check O - ring seal and replace if necessary.
2. Install the drain plug.



3. Wash the strainer assembly in clean, non flammable solvent and dry it. Install the strainer assembly and reconnect the hose.
4. Remove the dip stick/filter cap. Fill the drive axle housing with oil. See "Refill Capacities."
5. Start the lift truck with engine at low idle, place the directional control lever to the NEUTRAL.
6. Maintain the oil level between lower mark and upper mark on the dip stick/filter cap.

Steer Suspension – Inspect



1. Inspect the suspension mounting bolts. Tighten suspension mounting bolts, if necessary, to $240 \pm 30 \text{ N}\cdot\text{m}$ ($180 \pm 20 \text{ lb}\cdot\text{ft}$).



2. Look for leaks at the power steering hose connections.
3. Remove any trash buildup on the suspension or the steer axle.

Parking Brake - Test, Adjust

See topic, "Parking Brake - Test, Adjust" in "First 50-100 Service Hours or a Week".

Inching & Braking Control Shaft - Lubricate



1. Lubricate three fittings for the inching and brake pedal control shaft.

Horn and Lights (If Equipped) - Check



1. Press horn button, to determine if horn is operational.
2. Check and replace all defective gauges.
3. Check all lights such as warning, directional, backup, driving and flood lights for correct operation. Replace all burned out bulbs. Have repairs made if needed.

Inspect Vacuum Lines and Fittings (G420F(E)/G424F(E) Engine Only)

1. Visually inspect vacuum lines and fittings for physical damage such as brittleness, cracks and kinks. Repair/replace as required.
2. Solvent or oil damage may cause vacuum lines to become soft resulting in a collapsed line while the engine is running.
3. If abnormally soft lines are detected, replace as necessary.

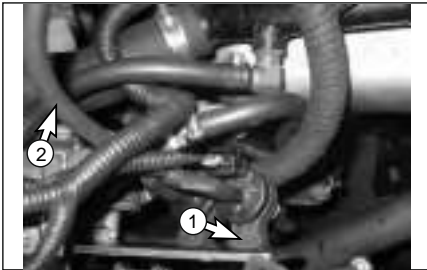

(1) Fuel Trim Valve(FTV)

(2) Vacuum lines

Inspect Electrical System (G420F(E)/G424F(E) Engine Only)

1. Check for loose, dirty or damaged connectors and wires on the harness including: Fuel lock-off, TMAP sensor, O2 sensor, Electronic throttle, Control Relays, Fuel Trim Valve, Foot Pedal, and crank sensor.
2. Repair and/or replace as necessary.

Fuel Trim Valve(FTV) Inspection (G420F(E)/G424F(E) Engine Only)

1. Visually inspect the Fuel trim valve for abrasions or cracking. Replace as necessary.
2. To ensure the valve is not leaking a blow-by test can be performed.
3. With the engine off, disconnect the electrical connector to the FTV.
4. Disconnect the vacuum lines form the FTV to the pressure regulator/converter, at the converter's tee connection.
5. Lightly blow through the vacuum line connected to the FTV. Air should not pass through the FTV when de-energized. If air leaks past the FTV when de-energized replace replace the FTV.

Fuel Filter (Diesel Engine Only) - Change

4TNE98 Diesel Engine Only

Replace the fuel filter at specified intervals to prevent contaminants from adversely affecting the diesel fuel flow

1. Stop the engine and allow it to cool.
2. Close the fuel cock of the fuel filter / water separator.
3. Remove the fuel filter with a filter wrench, turning it to the left (**Figure 5-13, (1)**). When removing the fuel filter, carefully hold it to prevent the fuel from spilling. Wipe up all spilled fuel.

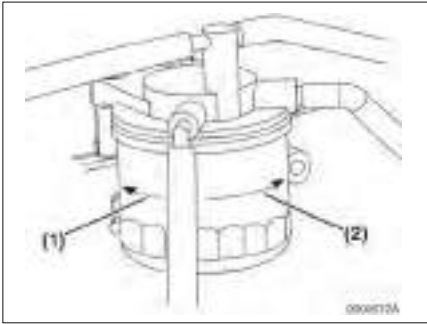

Figure 5-13

4. Clean the filter mounting surface and apply a small amount of diesel fuel to the gasket of the new fuel filter.
5. Install the new fuel filter. Turn to the right (**Figure 5-13, (2)**) and hand-tighten it only until it comes in contact with the mounting surface. Tighten to 14-17 ft•lb (19.6-23.5 N•m; 2.0-2.4 kgf•m) or one additional turn using the filter wrench.
6. Open the fuel cock of the fuel filter / water separator.
7. Prime the fuel system. See topic "Priming the Fuel System" in "When Required".
8. Check for leaks.

4TNE98 Diesel Engine Only

Replace the fuel filter at specified intervals to prevent contaminants from adversely affecting the diesel fuel flow.

1. Stop the engine and allow it to cool.
2. Close all fuel cocks in fuel line.
3. Disconnect the fuel filter sensor connector (**Figure 5-14, (1)**).

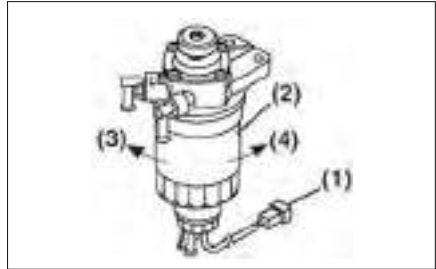

Figure 5-14

4. Place an approved container under fuel filter.
5. Carefully open the drain plug (**Figure 5-15, (1)**) to drain fuel from the fuel filter.
6. Remove the fuel filter (**Figure 5-14, (2)**) by turning it to the left (**Figure 5-14, (3)**). Wipe up all spilled fuel.
7. Remove the drain plug (**Figure 5-15, (1)**) from the fuel filter (**Figure 5-14, (2)**) by turning it to the left (**Figure 5-15, (3)**).
8. Check the condition of the drain plug O-ring (**Figure 5-15, (4)**). Replace the O-ring if damaged.

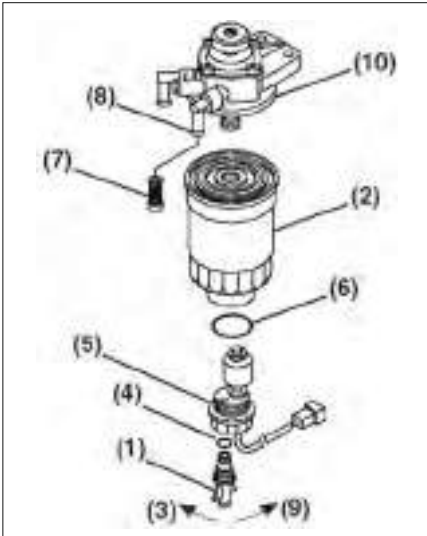

Figure 5-15

9. Set the drain plug aside for reinstallation.
10. Remove the fuel filter sensor assembly (**Figure 5-15, (5)**) by turning it to the left (**Figure 5-15, (3)**).
11. Carefully remove the in-line fuel filter (**Figure 5-15, (7)**) from the output nipple (**Figure 5-15, (8)**) that goes to the fuel injection pump.
12. Dispose of the fuel, fuel filters and O-ring (if replaced) properly. Follow the guidelines of the EPA or other government agency.
13. Carefully install the new in-line fuel filter (**Figure 5-15, (7)**) into the output nipple (**Figure 5-15, (8)**).
14. Carefully install the fuel filter sensor assembly (**Figure 5-15, (5)**) in the new fuel filter using the new O-ring supplied with the fuel filter (**Figure 5-15, (2)**) by turning the fuel filter sensor assembly to the right (**Figure 5-15, (9)**).
15. Install the drain plug (**Figure 5-15, (1)**) on the new fuel filter (**Figure 5-15, (3)**) by turning the drain plug to the right (**Figure 5-15, (8)**). Hand tighten only.
16. Clean the fuel filter mounting surface (**Figure 5-15, (10)**) and apply a small amount of diesel fuel to the gasket of the new filter.
17. Install the new fuel filter (**Figure 5-14, (2)**) by turning it to the right (**Figure 5-14, (4)**) until it contacts the mounting surface. Tighten one additional turn.
18. Open all fuel cocks in the fuel line.
19. Reconnect the fuel filter sensor connector (**Figure 5-14, (1)**).
20. Prime the fuel system. See Priming the Fuel System.
21. Check for fuel leaks.

Engine Oil & Filter (Diesel Engine Only) - Change

See topic, "Engine Oil & Filter (Diesel Engine Only) - Change" in " First 50-100 Service Hours or a Week".

Water Separator (4TNV98 Diesel Engine Only) - Clean

Periodically clean the fuel filter / water separator element and inside cup.

1. Position an approved container under the cup (**Figure5-16, (1)**) of the fuel filter/water separator to collect the contaminants.

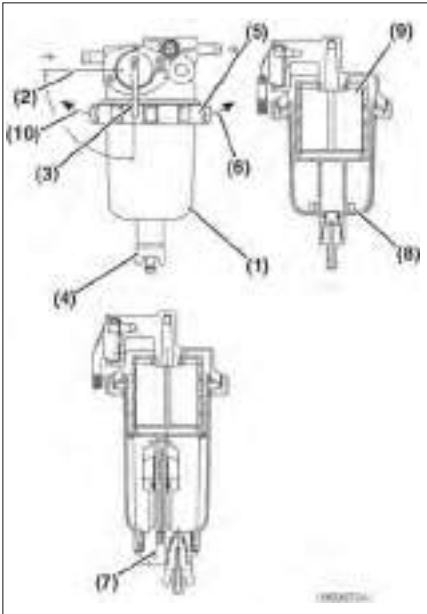

Figure5-16

2. Close (**Figure5-16, (2)**) the fuel cock (**Figure5-16, (3)**).
3. Loosen the drain cock (**Figure5-16, (4)**) and drain the contaminants. See Drain Fuel Filter/Water Separator.
4. Turn the retaining ring (**Figure5-16, (5)**) to the left (**Figure5-16, (10)**) and remove the cup (**Figure5-16, (6)**). If equipped, disconnect the sensor wire (**Figure5-16, (7)**) from the cup before removing the cup.
5. Carefully hold the cup to prevent fuel from spilling. If you spill any fuel, clean up the spill completely.
6. Remove the float ring (**Figure5-16, (8)**) from the cup. Pour the contaminants into the container and dispose of it properly.
7. Clean the element (**Figure5-16, (9)**) and inside cup. Replace the element if it is damaged.
8. Install the element and O-ring in the bracket.
9. Position the float ring in the cup.
10. Check the condition of the cup O-ring. Replace if necessary.
11. Install the cup to the bracket by tightening the retaining ring to the right (**Figure5-16, (6)**) to a torque of 11-15 ft•lb (15-20 N•m; 1.5-2.0kgf•m).
12. Close the drain cock. Reconnect the sensor wire if equipped.
13. Open the fuel cock (**Figure5-16, (3)**).
14. Prime the fuel system. See topic, "Priming the Fuel System" in "When required".
15. Check for leaks

Every 1000 Service Hours or 6 Months

You must read and understand the warnings and instructions contained in the Safety section of this manual, before performing any operation or maintenance procedures.

Hydraulic Return Filter, Breather & Strainer - Check, Change

WARNING

Hot oil and components can cause personal injury. Do not allow hot oil or components to contact skin.

Park the lift truck level with the forks lowered, parking brake engaged, transmission in NEUTRAL and the engine stopped.



1. Loosen the bolts of the hydraulic tank top plate assembly.
2. Remove the return filter from tank top plate assembly.
3. Install new return filter by hand.
4. Remove the suction strainer from the tank.
5. Install the new strainer by hand.
6. Install the tank top plate assembly and fasten the bolts.



Typical Example

7. Remove and discard the air breather.
8. Install a new air breather.
9. Start the engine and operate the hydraulic controls, and the steering system, through a few cycles to fill the lines. Look for oil leaks.
10. Stop the engine and check the oil level. With all cylinders retracted, maintain the oil level to the FULL mark on the dipstick/filter cap assembly.

Transmission Oil, Oil Filter & Strainer - Check, Clean, Change

See topic, "Transmission Oil, Oil Filter & Strainer-Check, Clean, Change" in "First 50 - 100 Service Hours"

Lift Chains - Test, Check, Adjust

Lift Chain Wear Test

Inspect the part of the chain that is normally operated over the cross head roller. When the chain bends over the roller, the movement of the chain against each other causes wears. Inspect to be sure that chain link pins do not extend outside of the link hole. If any single link pin is extended beyond its connecting corresponding link, it should be suspected of being broken inside of its link hole. Lift chains are required to check for wear about every 1,000 service hours or 6 months.

Chain wear test is a measurement of wear of the chain links and pins. Take the following steps to check chain wear.

1. Lift the mast and carriage enough for getting tension on lift chains.



Typical example

2. Measure precisely ten links of chain distance at the center of pins in millimeter.
3. Calculate chain wear rate*.
4. If the chain wears rate is 2% or more, replace the lift chain.

*Chain wear rate (%)

$$= \left(\frac{\text{Actual measurement} - \text{Pitch}^{**} \times 10}{\text{Pitch}^{**} \times 10} \right) \times 100$$

**Chain Pitch = 19.05mm (0.75in)

Check for Equal Tension



Typical example

Lift the carriage and the mast high enough for getting tension on lift chains. Check the chains, and make sure the tension is the same. Lift chains are required to check for equal tension about every 1,000 service hours or 6 months.

WARNING

Personal injury can be caused by sudden movement of the mast and carriage. Keep hands and feet clear of any parts that can move.

Lift Chain Adjustment



Typical example for carriage equal tension

If the tension is not the same on both chains, take the procedure as follows.

NOTE: If carriage height is not correct, make adjustments by following procedures.

Carriage Chain Adjustment

Make sure that carriage height is correct. If correct, adjust the chain for equal tension. If not, adjust the chain for correct carriage height by adjusting anchor nuts (1), (2).

NOTE: See the previous section, "Carriage Roller Extrusion" in "When Required" for proper height of carriage.

1. Fully lower the carriage and tilt mast forward or lift the carriage and put blocks under the carriage to release the tension from the lift chains.
2. Loosen nut(1) and adjust nut(2) to get proper distance from bottom of inner upright to the bottom of carriage bearing.

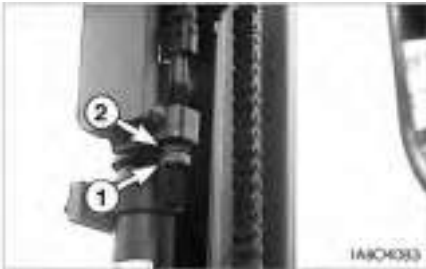

Typical example for carriage chain of STD mast

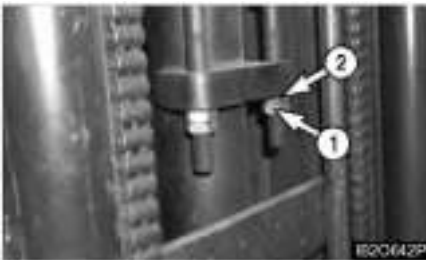

Typical example for carriage chain of FF, FFT mast

3. Make adjustment anchor nut (1), (2) for equal chain tension.
4. Set the mast vertical and raise the carriage and check equal chain tension. If not equal, repeat the same procedure as step 1 through step 3.
5. Put LOCTITE No. 242 Tread lock on the threads of the anchor nuts (1), (2) after the adjustment is completed.

Mast Chain Adjustment - FF, FFT Mast

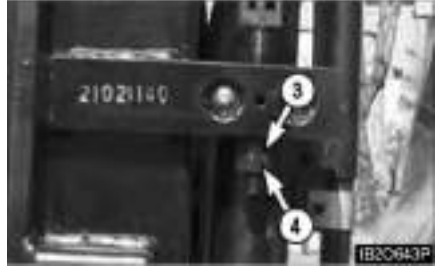

Typical example for FF mast

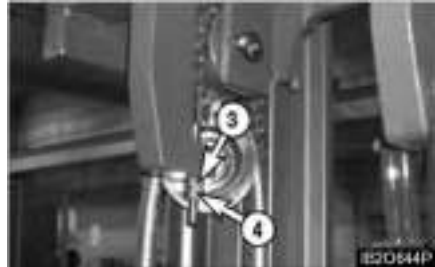

Typical example for FFT mast

Make sure that mast height is correct. If correct, adjust chain for equal tension. If not, adjust mast chain for correct mast height by adjusting anchor nuts (3), (4).

NOTE: See the previous section, "Carriage Roller Extrusion" in "When Required" for proper inner mast height.

1. Lift the inner mast and put blocks under the inner mast to release the tension from the lift chains.
2. Loosen nut (3) and adjust nut (4) to make inner mast rail flush with outer mast rail bottom.
3. Make adjustment anchor nuts (3), (4) for equal chain tension.
4. Raise the inner mast and check equal chain tension. If not equal, repeat the same procedure as step 1 through step 3.
5. Put LOCTITE No. 242 tread lock on the threads of the anchor nuts (3), (4) after the adjustment is completed.

Universal Joint – Inspect



Check for worn or damaged bearings. Have worn or damaged bearings replaced. Check for loose retaining bolts and nuts. Tighten the bolts and nuts, if necessary.

Air Intake System - Change

Changing Primary Element

See topic, "Air Intake System - Check, Clean" in "Every 250 Service Hours or Monthly"

Changing Secondary Element

1. Remove the primary air cleaner element. See topic "Servicing Filter Element." Clean the inside of the air cleaner housing and cover.



2. Remove the secondary element. Inspect the gasket between the air cleaner housing and the engine inlet. Replace the gasket if it is damaged.

NOTICE

Always replace the secondary element. Do not attempt to reuse it by cleaning.

3. Install a new secondary element. Install a new or cleaned primary element. Install the cover. Tighten the latches.
4. Start the engine and observe the air cleaner service indicator. If the indicator shows RED after installing a new secondary element and a cleaned primary (outer) element, replace the cleaned primary filter with a new element.
5. Stop the engine. Close the hood and seat assembly.

Inspect Coolant Hoses (LP, Dual Fuel Engine Only)

1. Visually inspect coolant hoses and clamps. Remember to check the two coolant lines that connect to the pressure regulator/convertor.
2. Replace any hoses that shows signs of swelling, cracking, abrasion or deterioration.

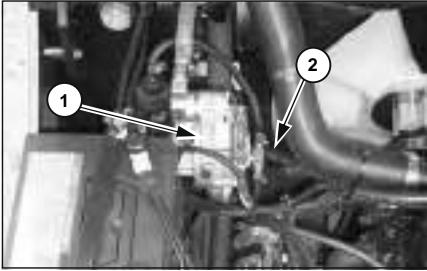

(1) LP Regulator/Converter
(2) Coolant hoses

LP Regulator/Converter Inspection (LP, Dual Fuel Engine Only)

1. Visually inspect the pressure regulator/convertor housing for coolant leaks. Refer to the pressure regulator/convertor section of the service manual if maintenance is required.

NOTE: For pressure testing and internal inspection of the pressure regulator/convertor, refer to the pressure regulator/convertor section of the service manual.

Fuel Lines & Fittings - Check

Visually inspect fuel lines and fittings for physical damage. Replace as required.

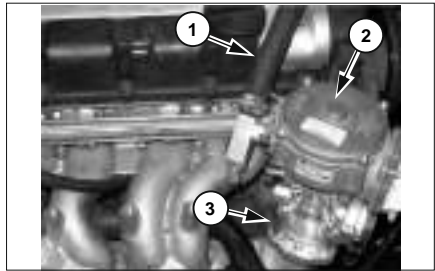

(1) Fuel lines
(2) LP mixer
(3) Throttle Assembly

Inspect Mixer Assembly (G420F(E)/G424F(E) Engine Only)

Refer to the LP mixer section of the engine service manual for procedures.

Inspect Throttle Assembly (G420F(E)/G424F(E) Engine Only)

1. Visually inspect the throttle assembly motor housing for coking, cracks and missing cover-retaining clips. Repair and/or replace as necessary.

NOTE: Refer to the LP mixer and throttle section of the service manual for procedures on removing the mixer and inspecting the throttle plate.

Engine Valve Lash (Diesel Engine Only) - Check, Adjust

NOTICE

The valve clearances are to be adjusted at the times of the following situations.

- When the engine is overhauled and the cylinder heads are disassembled.
- When severe noise comes from valve train.
- When the engine is not normally operated even though there is no trouble in the fuel system.

WARNING

To prevent possible injury when adjusting diesel engines, do not use the starter motor to turn the flywheel.

Hot engine components can cause burns. Allow additional time for the engine to cool before measuring valve clearance.

NOTICE

Measure the valve lash with the engine stopped. To obtain an accurate measurement, allow at least 20 minutes to cool the engine cylinder head and block temperature.

Set the clearance to the nominal appropriate clearance given in the "Valve Clearance Setting" shown below.

Valve Clearances		
Engine	Valve	Clearance
3.3 liter (4TNV98 & 4TNE98) Diesel	Exhaust Valves	0.2 mm (.008 in)
	Intake Valves	0.2 mm (.008 in)

Refer to the "Service Manual" for the complete valve adjustment procedure.

In regards to G420F(E) and G424F(E) Engines, valve adjustment is not necessary because of automatic adjusting system

Every 1500 Service Hours or 9 Months

Inspect Ignition System (LP, Gasoline & Dual Fuel Engines Only)

1. Disconnect Battery Cables.
2. Remove and inspect the spark plugs. Replace as required.
3. Test secondary cables with an Ohmmeter. If the maximum resistance is higher than 25 kOhms, repair and/or replace(G424F(E) engine only).
4. Inspect the ignition coil for cracks and heat deterioration. Visually inspect the coil heat sink fins. If any fins are broken replace as required.

G420F(E) Engine



G424F(E) Engine

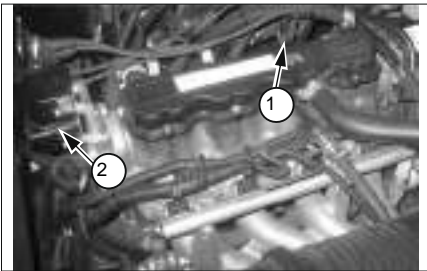

- (1) Spark Plug Cables
(2) Ignition Coil

Replace Spark Plugs (G424F(E) LP, Dual Fuel Engine Only)

1. Disconnect Battery Cables.
2. Using a gentle twisting motion remove the high voltage cables from the spark plugs. Replace any damaged cables.
3. Remove the spark plugs.
4. Gap the new spark plugs to the proper specifications.
G424F(E) Engine : 0.9 mm
5. Apply anti-seize compound to the spark plug threads and install.
G424F(E) Engine : 25 N•m (18 lb•ft)

WARNING

DO NOT OVERTIGHTEN THE SPARK PLUGS.

6. Re-install the high voltage cables.

Replace LP Fuel Filter Element (LP, Dual Fuel Engine Only)

Park the lift truck in an authorized refueling area with the forks lowered, parking brake applied and the transmission in Neutral.

1. Close the fuel shutoff valve on the LP-Fuel tank. Run the engine until the fuel in the system runs out and the engine stops.
2. Turn off the ignition switch.
3. Scribe a line across the filter housing covers, which will be used for alignment purposes when re-installing the filter cover.

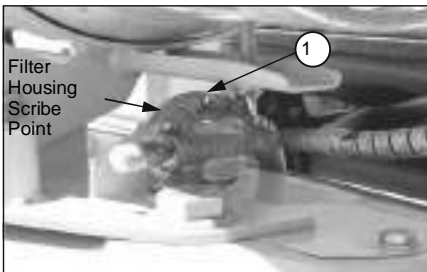

(1) screws

4. Remove the cover retaining screws (1).

Fuel Filter (LP Engine Only)

Disassembly

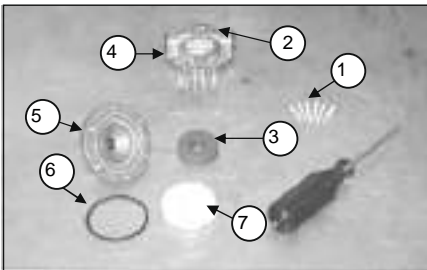

1. Remove top cover (2), magnet (3), spring (4), and filter element (7) from bottom cover (5).
2. Replace the filter element (7).

3. Check bottom cover O-ring seal (6) for damage. Replace if necessary.
4. Re-assemble the filter assembly aligning the scribe lines on the top and bottom covers.
5. Install the cover retaining screws, tightening the screws in an opposite sequence across the cover.
6. Open the fuel valve by slowly turning the valve counterclockwise.
7. Crank the engine several revolutions to open the fuel lock-off. **DO NOT START THE ENGINE.** Turn the ignition key switch to the off position.
8. Check the filter housing, fuel lines and fittings for leaks. Repair as necessary.

Testing Fuel Lock-off Operation (LP Engine Only)

1. Start engine.
2. Locate the electrical connector for the fuel lock
3. Disconnect the electrical connector.
4. The engine should run out of fuel and stop within a short period of time.
5. Turn the ignition key switch off and re-connect the fuel lock-off connector.

NOTE: The length of time the engine runs on trapped fuel vapor increases with any increase in distance between the fuel lock-off and the pressure regulator/converter.

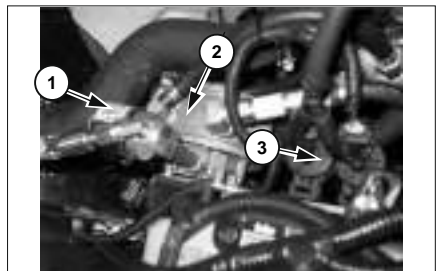

(1) LP fuel lock-off
(2) Regulator/Converter
(3) Fuel Trim valve (FTV)

Fuel Injectors (Diesel Engine Only) – Inspect, Clean, Test

⚠ WARNING



HIGH-PRESSURE HAZARD!

Avoid skin contact with the high-pressure diesel fuel spray caused by a fuel system leak such as a broken fuel injection line. High-pressure fuel can penetrate your skin and result in serious injury. If you are exposed to high-pressure fuel spray, obtain prompt medical treatment.

NEVER check for a fuel leak with your hands. ALWAYS use a piece of wood or cardboard. Have your authorized Yanmar industrial engine dealer or distributor repair the damage.

Failure to comply could result in death or serious injury.

Proper operation of the fuel injectors is required to obtain the optimum injection pattern for full engine performance. The EPA / ARB requires that the fuel injectors are inspected, cleaned and tested every 1500 hours. See *Testing of Fuel Injectors on Service Manual*

Crankcase Breather System (4TNV98 Diesel Engine Only) - Inspect

Proper operation of the crankcase breather system is required to maintain the emission requirements of the engine. The EPA / ARB requires that the crankcase breather system is inspected every 1500 hours.

4TNV98 engines use a crankcase breather system that has a spring-backed diaphragm (Figure5-19, (1)) in the valve cover (Figure5-19, (2)). When the crankcase pressure reaches a predetermined value, the diaphragm opens a passage that allows crankcase fumes to be routed to the intake manifold.

To inspect the diaphragm and spring (Figure5-19, (3)):

1. Remove the bolts retaining the diaphragm cover (Figure5-19, (4)).

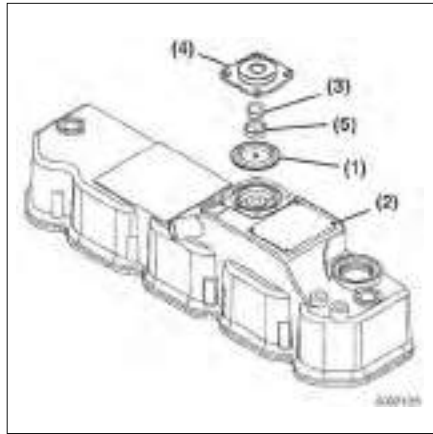

Figure5-19

2. Remove the diaphragm cover, spring, diaphragm plate (Figure5-19, (5)) and diaphragm.
3. Inspect the diaphragm for tears. Inspect the spring for distortion. Replace components if necessary.
4. Reinstall the diaphragm, diaphragm plate, spring and diaphragm cover. Tighten the diaphragm bolts to specified torque.

Failure of the diaphragm and / or spring will cause the loss of pressure control and allow an excessive amount of crankcase fumes to be routed to the intake manifold. This could result in excessive deposits in the intake system, high engine exhaust smoke levels, excessive engine oil consumption, and / or engine run-on due to the burning of the engine oil

Every 2000 Service Hours or Yearly

You must read and understand the warnings and instructions contained in the Safety section of this manual, before performing any operation or maintenance procedures.

Engine Valve Lash (Diesel Engine Only) – Check, Adjust

See topic “Engine valve Lash (Diesel Engine Only) – Check, Adjust”. In First 250 Service hours.

Steer Wheel Bearings - Reassemble

Park the lift truck level with the forks lowered, parking brake engaged, transmission in NEUTRAL and the engine stopped.

NOTE: The procedure is shown on a GC-Series lift truck. It is the same for D, G-Series lift trucks.



Typical Example

1. Lift the steer wheels off the ground. Place stands or blocking under the frame and steer axle to support the lift truck.



Typical Example

2. Remove the hub cap which is pressed into the wheel hub.

3. Straighten the lock washer tangs.

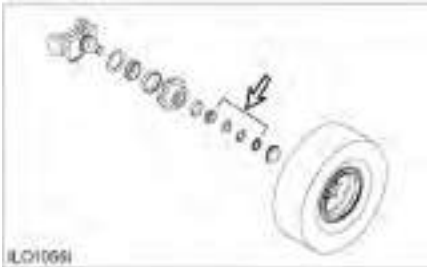

4. Remove the locknut, lock washer and flat washer.
Remove the outer wheel bearing.

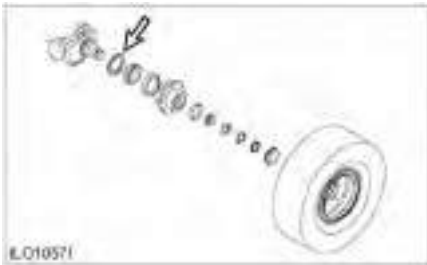

5. Remove the wheel assembly. Examine the seal for damage and wear. Replace the seal if necessary.
6. Remove the inner bearing. Clean and lubricate the steering knuckle. Reassemble both the inner and outer bearing cones.
7. Install the inner bearing. Lubricate the seal and install the wheel assembly on the knuckle.

8. Install the outer wheel bearing and the out washer. Install a new lock washer and fit the locknut.



Typical Example

9. Tighten the locknut to 135 N•m (100 lb•ft), while turning wheel hub to seat the bearing.
10. Loosen the locknut. Retorque it to 50 ± 5 N•m (37 ± 4 lb•ft). Bend the lock washer tang to secure locknut.
11. Install the hub cap.
12. Raise the lift truck and remove the blocking.
Lower the lift truck to the ground.

Drive Wheel Bearing (Power Shaft and Drive Wheel) – Reassemble

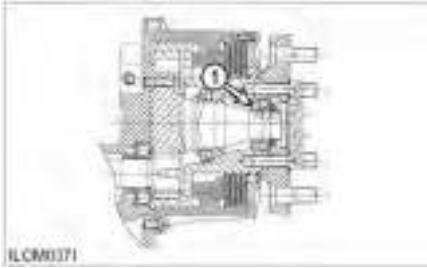

Consult your DOOSAN lift truck dealer for the proper wheel bearing reassembling procedure. Packing of bearings and adjustment procedure must be made by a trained mechanic or dealer personnel.

Pack power shaft bearings (1) and spindle bearings (2). Pack ring gear (3) to the depth of the teeth.

D, G-Series Lift Trucks

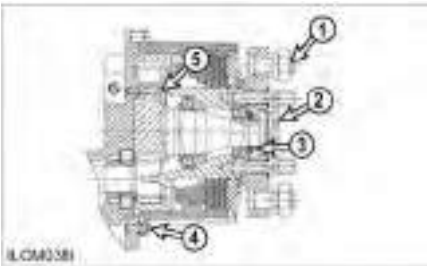

Torque for single or dual wheel mounting nuts (1) is $644 \pm 34 \text{ N}\cdot\text{m}$ ($470 \pm 25 \text{ lb}\cdot\text{ft}$).

Torque for adapter assembly bolts (2) is $285 \pm 13 \text{ N}\cdot\text{m}$ ($210 \pm 10 \text{ lb}\cdot\text{ft}$).

Tighten wheel bearing nut (3) to $135 \text{ N}\cdot\text{m}$ ($100 \text{ lb}\cdot\text{ft}$) while the wheel is turned in both directions. Loosen the nut completely and tighten nut again to $50 \pm 5 \text{ N}\cdot\text{m}$ ($37 \pm 4 \text{ lb}\cdot\text{ft}$). Bend the lock washer tab into a groove of the nut.

Torque for bolts (4) that hold cover to drive axle housing is $55 \pm 10 \text{ N}\cdot\text{m}$ ($40 \pm 7 \text{ lb}\cdot\text{ft}$).

Apply Loctite No.242 to threads of spindle bolts (5). Torque for spindle bolts is $115 \pm 14 \text{ N}\cdot\text{m}$ ($85 \pm 10 \text{ lb}\cdot\text{ft}$).

GC-Series Lift Trucks.

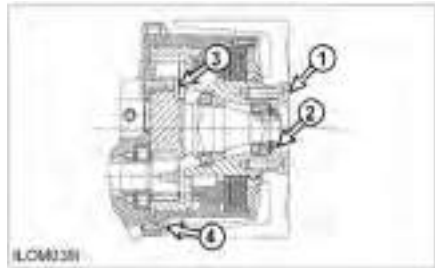

Torque for wheel bolts (1) is $270 \pm 25 \text{ N}\cdot\text{m}$ ($200 \pm 20 \text{ lb}\cdot\text{ft}$).

Tighten wheel bearing nut (2) $135 \text{ N}\cdot\text{m}$ ($100 \text{ lb}\cdot\text{ft}$) while the wheel is turned in both directions. Loosen the nut completely and tighten nut again to $50 \pm 5 \text{ N}\cdot\text{m}$ ($37 \pm 4 \text{ lb}\cdot\text{ft}$). Bend the lock washer tab into a groove of the nut.

Torque for bolts (3) that hold cover to drive axle housing is $55 \pm 10 \text{ N}\cdot\text{m}$ ($40 \pm 7 \text{ lb}\cdot\text{ft}$).

Apply Loctite No. 242 to threads of spindle bolts (4). Torque for spindle bolts is $115 \pm 14 \text{ N}\cdot\text{m}$ ($85 \pm 10 \text{ lb}\cdot\text{ft}$).

Cooling System – Clean, Change

WARNING

At operating temperature, the engine coolant is hot and under pressure.

Steam can cause personal injury.

Check the coolant level only after the engine has been stopped and the filler cap is cool enough to touch with your bare hand.

Remove the filler cap slowly to relieve pressure.

Coolant is included antifreeze for forbidding corrosion. Avoid contact with the skin and eyes to prevent personal injury.

Use all cleaning solution with care.

The Lift truck must be level, the forks lowered, the parking brake engaged, the transmission in NEUTRAL and the engine stopped and cool.

1. Turn the radiator cap slowly to relieve the pressure, and then remove the cap.



2. Remove the drain plug or water hose on engine block.



4TNE98 3.3L Diesel Engine

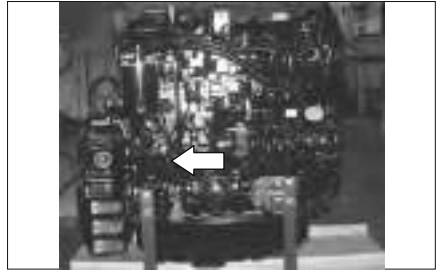

4TNV98 3.3L Diesel Engine



G420F(E) 2.0L LPG/Gasoline Engine



G424F(E) 2.4L LPG/Gasoline Engine

3. Open the radiator drain valve. Allow the coolant to drain into a suitable container. Drain the recovery bottle.



NOTICE

Hold the drain port when the radiator drain valve is turned because the tank and the drain port are separated.



4. After draining the coolant completely, close the radiator drain valve and the block drain plug, fill the engine and the radiator full with a radiator cleaner, and clean the engine and the radiator.
5. Start and run the engine for 30 minutes.
6. Stop the engine and drain the cleaning solution into a suitable container.
7. Flush the system with clean water, until draining water is clear.
8. Close the drain valve and install the block drain plug. Fill coolant to top of the filler neck.
9. Start and run the engine to stabilize the coolant level. See topic, "Coolant Level – Check" in "Every 10 Service hours or Daily".

Forks – Inspect

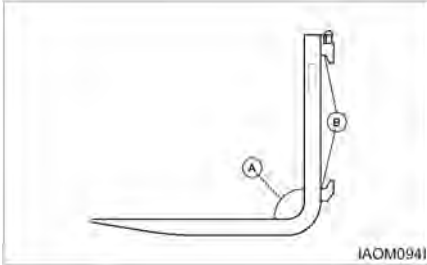

Forks should be inspected, at a minimum, every 12 months. If the truck is being used in a multi-shift or heavy duty operation, they should be checked every six months.

1. Inspect the forks carefully for cracks. Special attention should be given to the heel section (A), all weld areas and mounting brackets (B). Inspect the top and bottom hooks on forks used on hook type carriages and tubes on shaft mounted forks.

Forks with cracks should be removed from service.

"Wet Test" magnetic particle inspection is generally preferred due to its sensitivity and the ease of interpreting the results. Portable equipment is usually recommended so it can be moved to the lift truck.

Inspectors should be trained and qualified in accordance with The American Society for Non Destructive Testing, Level II Qualifications.

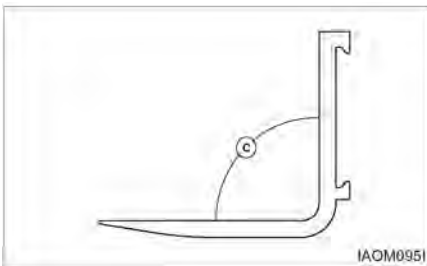

2. Check the angle between the upper face of the blade and the front face of the shank. The fork should be withdrawn from service if angle (C) exceeds 93 degrees or deviates by more than 3 degrees from an original angle other than 90 degrees, as may be found in some special application forks.

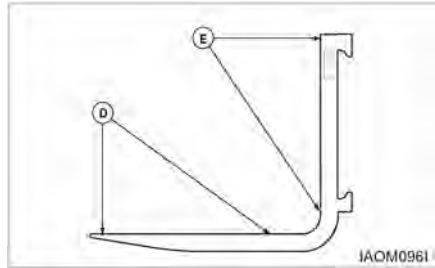

3. Check the straightness of the upper face of blade (D) and the front face of shank (E) with a straight edge.

The fork should be withdrawn from service if the deviation from straightness exceeds 0.5 percent of the length of the blade and/or the height of the shank respectively 5 mm/1000 mm (0.18"/36").

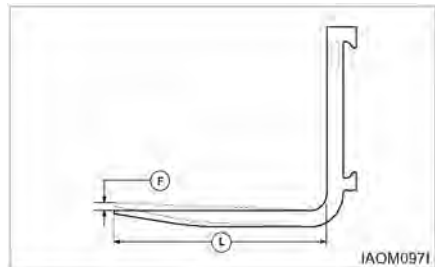

4. Check the difference in height of one fork tip to the other when mounted on the fork carrier. A difference in fork tip height can result in uneven support of the load and cause problems with entering loads.

The maximum recommended difference in fork tip elevation (F) is 6.5 mm (0.25") for pallet forks and 3 mm (0.125") for fully tapered forks. The maximum allowable difference in fork tip elevation between the two or more forks is 3 percent of blade length (L).

Replace one or both forks when the difference in fork tip height exceeds the maximum allowable difference. Contact your local DOOSAN Lift Truck Dealer for further information.

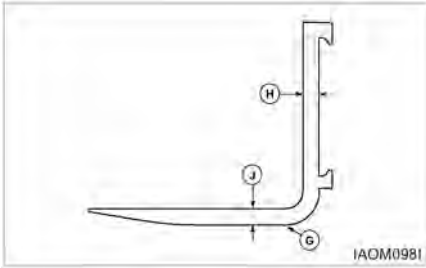

5. Check the fork blade (J) and shank (H) for wear with special attention to the heel (G). The fork should be withdrawn from service if the thickness is reduced to 90 percent or less of the original thickness.

Fork blade length may also be reduced by wear, especially on tapered forks and platens. Remove the forks from service when the blade length is no longer adequate for the intended loads.

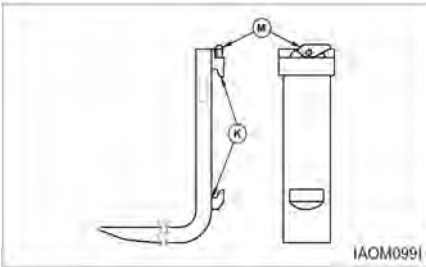

6. Check the fork mountings (K) for wear, crushing and other local deformation, which can cause excessive side to side wobble of the forks. Excessive clearance on hook type forks may allow them to fall from the carrier. Forks which show visible signs of such damage should be removed from service.
7. Check the positioning lock and other fork retention devices to make sure they are in place and working.

Hook type forks use a spring loaded pin (M), located in the top hook, to engage notches in the top carriage bar to hold the fork in place.

When adjusting the fork spacing, the forks are prevented from sliding off the end of the carriage by stop blocks. These stop blocks are at both ends of the carriage and in the path of the bottom fork hook. The load backrest extension may be used in place of the stop blocks in some cases.

Shaft mounted forks may use set collars or spacers on the shaft to either side of the fork. They may also use U bolts, pins, or similar devices which engage the fork through the top structure of the carriage.

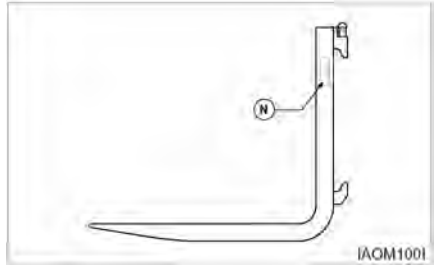

8. Check fork markings (N) for legibility. Renew markings as required to retain legibility.
9.
 - a. Lift the mast and operate the tilt control lever, until the top surface of the forks is parallel with the floor. Place two straight bars that are the same width as the carriage, across the forks as shown.
 - b. Measure the distance from the bottom of each end of the two bars to the floor. The forks must be parallel within 3 mm (.12 in) for Full Tapered and Polished (FTP) forks, all other forks 6.4 mm (.25 in), for their complete length.
 - c. Put one fork, one third from the tip, under a fixture that will not move. Then operate the tilt control with caution until the rear of the truck lifts just off the floor. Follow the same procedure with the second fork. Repeat Step a.

Every 2500 Service Hours or 15 Months

You must read and understand the warnings and instructions contained in the Safety section of this manual, before performing any operation or maintenance procedures.

Hydraulic Oil - Check, Clean, Change

WARNING

Hot oil and components can cause personal injury. Do not allow hot oil or components to contact skin.

Park the lift truck level with the forks lowered, parking brake engaged, transmission in NEUTRAL and the engine stopped.



1. Remove the hydraulic tank drain plug. Allow the oil to drain into a suitable container. Clean and install the plug.
2. Remove the dipstick/filter cap assembly.
3. Fill the hydraulic tank. See topic "Refill Capacities". Install the dipstick/filter cap assembly.
4. Start the engine and operate the hydraulic controls, and the steering system, through a few cycles to fill the lines. Look for oil leaks.
5. Stop the engine and check the oil level. With all cylinders retracted, maintain the oil level to the FULL mark on the dipstick/filter cap assembly.

Inspect Battery System

1. Clean battery outer surfaces with a mixture of baking soda and water.
2. Inspect battery outer surfaces for damage and replace as necessary.
3. Remove battery cable and clean, repair and/or replace as necessary.



Replace Oxygen Sensor (G420F(E)/G424F(E) Engine Only)

G420F(E) Engine



G424F(E) Engine

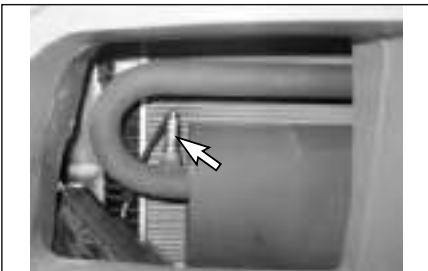
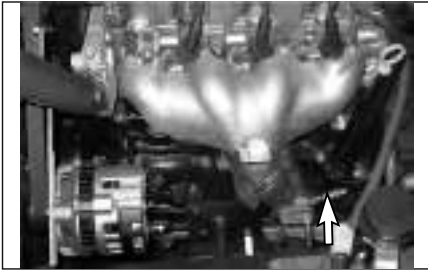

When indicated by MIL, replace oxygen sensor on the exhaust manifold and oxygen sensor on muffler assembly.

1. Stop engine and wait until the exhaust pipe and exhaust pipe is cooled.
2. Disconnect the electrical connector of oxygen sensor
3. Remove oxygen sensor

4. Assemble new oxygen sensor
Tightening torque : 45 N•m (32.5 lb•ft)
5. Connect the electrical connector of oxygen sensor

WARNING

When assembling the filters, check the arrow mark on the filter surface.

The arrow mark position is same as fuel flow direction.

Replace Spark Plugs (G420F(E) Engine Only)

1. Disconnect Battery Cables.
2. Remove the ignition wiring harness.
3. Remove the ignition coil assy.
4. Remove spark plugs.
5. Gap the new spark plugs to the proper specifications.
G420F(E) Engine : 0.7 ~ 0.8 mm
6. Apply anti-seize compound to the spark plug threads and install.
G420F(E) Engine : 25 N•m (18 lb•ft)

WARNING

DO NOT OVERTIGHTEN THE SPARK PLUGS.

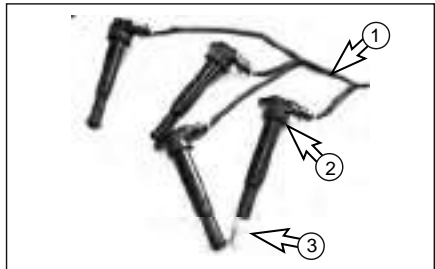

(1) Ignition wiring harness (2) Ignition Coil Assy (3) Spark plug

Checking the TMAP Sensor (G420F(E)/G424F(E) Engine Only)

1. Verify that the TMAP sensor (F) is mounted tightly into the manifold adapter (E), with no leakage.
2. If the TMAP is found to be loose, remove the TMAP retaining screw and the TMAP sensor from the manifold adapter.
3. Visually inspect the TMAP O-ring seal for damage. Replace as necessary.
4. Apply a thin coat of an approved silicon lubricant to the TMAP o-ring seal.
5. Re-install the TMAP sensor into the manifold adapter and securely tighten the retaining screw.

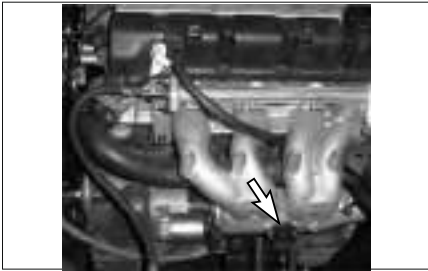

Inspect for Intake Leaks (G420F(E)/G424F(E) Engine Only)

1. Visually inspect the intake manifold, throttle assembly (2), and manifold adapters (3), for looseness and leaks. Repair as necessary.

Replace PCV Valve and breather element - Change (LP, Gasoline and Dual Fuel Engines)

G420F(E) Engine

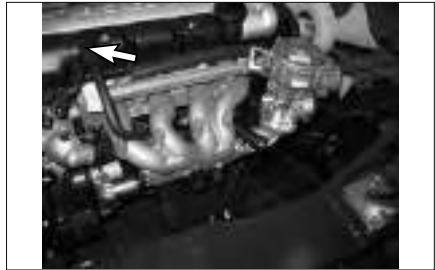

G424F(E) Engine

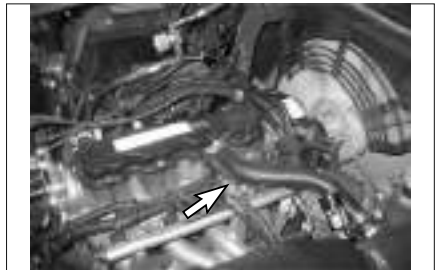

1. Loosen the hose clamps and remove the PCV valve.
2. Assemble new PCV valve and hose.
3. Tighten the hose clamps

Every 3000 Service Hours or 18 Months

You must read and understand the warnings and instructions contained in the Safety section of this manual, before performing any operation or maintenance procedures.

Timing Belt [G420F(E)/G424F(E) LP, Gasoline, Dual Fuel Engine Only] - Change

See the "Service manual" for the procedure and specification.

 **WARNING**

G420F(E) is dual over-head CAM engine. If timing belt is not replaced on time, engine could be damaged.

Index

#

12 Months Inspection	133
4TNE98 Diesel Engine Only	150,153,175,182
4TNV98 Diesel Engine Only	150,152,174,182

A

Accelerator Pedal	69
Adjustments	118
Advanced Diagnostics	99
After Starting the Engine	81
Air Cleaner Indicator-Check	157
Air Intake System - Change	188
Air Intake System - Check, Clean	167
Antifreeze	138
Attachment Abbreviations (Includes Special Forks)	61
Auto Shift Controller ASC-100 (If Equipped)	118
Automatic mode (Direction Inhibit mode)	119
Avoiding Lift Truck Tipover	21

B

Basic Troubleshooting (Gasoline)	93
Basic Troubleshooting(LP)	86
Battery Terminal - Clean, Inspect	171
Before Operating the Lift Truck	12
Before Starting the Engine	74
Before Starting the Lift Truck	11
Before Storage	127
Belts - Check, Adjust	176
Bent or Twisted Forks	131
Brake Fluid	142
Brake Oil Level - Check	169
Bulbs	149
Burn Prevention	15

C

Capacity Chart (With Sideshifter cushion)	55,56,57,58
Capacity Chart (With Sideshifter Pneumatic)	47,48,49,50
Capacity Chart (Without Sideshifter cushion)	51,52,53,54
Capacity Chart (Without Sideshifter Pneumatic)	43,44,45,46
Carriage Roller Extrusion – Adjust	154
Causes of Fork Failure	131
Center of Gravity (CG)	21
Changing From Gasoline to LP – Gas	79
Changing From LP to Gasoline	79
Changing LP Tanks	72

Changing Primary Element	188
Changing Secondary Element	188
Chassis Pivot Eyebolts-Lubricate	176
Check for Equal Tension	186
Check Inflation and Damage	154
Check Operation	177
Checking Service Indicator	157
Checking the TMAP Sensor (G420F(E)/G424F(E) Engine Only)	203
Circuit Breaker	68,150
Cleaning Primary Filter Elements	168
Coolant Information	137
Coolant Level – Check	156
Coolant Water	138
Cooling System – Clean, Change	197
Cooling System Specifications	137
Crankcase Breather System (4TNV98 Diesel Engine Only) - Inspect	193
Crosshead Rollers - Inspect	177
Crushing or Cutting Prevention	14
Cylinder Rod Extension-Adjust	177

D

D, G-Series Lift Trucks	196
Daily Inspection	132
Diagnostics Features	119
Diesel Engine	77
Diesel Engines	155
Diesel Specifications	139
Direction Control Lever	69
Direction Inhibit Point	118
Disassembly	192
Display for Operator	119
Display for Troubleshooting	119
Displaying Fault Codes (DFC) from SECM Memory	99
Drive Axle Oil - Change	164
Drive Axle Oil & Strainer - Change, Clean	179
Drive Axle Oil Level - Check	170
Drive Axle Oil	141
Drive Wheel Bearing (Power Shaft and Drive Wheel) – Reassemble	196
Dual Fuel System	79

E

Electrical Disconnect Switch (If Equipped)	66
Engine Compartment	66
Engine Oil & Filter (Diesel Engine Only) - Change	161,183
Engine Oil & Filter (LP & Gasoline Engine Only) - Change	171
Engine Oil (DEO and EO)	141
Engine Oil Level - Check	155
Engine Valve Lash (Diesel Engine Only) – Check, Adjust	190,194
Environment Management	3

Environment Protection.....	130
Every 10 Service Hours or Daily	155
Every 1000 Service Hours or 6 Months	185
Every 1500 Service Hours or 9 Months	191
Every 2000 Service Hours or Yearly	194
Every 250 Service Hours or Monthly	167
Every 2500 Service Hours or 15 Months.....	201
Every 3000 Service Hours or 18 Months.....	204
Every 500 Service Hours or 3 Months	176

F

Fatigue	131
Fire or Explosion Prevention.....	15
First 250 Service Hours or a Month	166
First 50 - 100 Service Hours or a Week.....	161
First Installation.....	132
Fluid Penetration	14
Foreword	2
Fork Inspection	132
Forks – Inspect.....	199
Fuel Filter (Diesel Engine Only) - Change.....	182
Fuel Filter (LP Engine Only)	192
Fuel Injectors (Diesel Engine Only) – Inspect, Clean, Test.....	193
Fuel Lines & Fittings - Check.....	189
Fuel Selector Switch (G420F(E)/G424F(E) Dual Fuel Only).....	68
Fuel Specifications	139
Fuel Sulfur Content	139
Fuel Tank Filter Cap and Screen (If Equipped) - Clean	148
Fuel Trim Valve(FTV) Inspection (G420F(E)/G424F(E) Engine Only).....	181
Fuel Types	139
Fuses.....	149
Fuses, Bulbs, Circuit Breaker & Relay - Change, Reset	149

G

G420F Engine and G424F Engine.....	85
G420F(E) Engine.....	191,202
G420F(E) Gasoline, LP and Dual Fuel Engines .	172
G420FE Engine and G424FE Engine.....	84
G424F(E) Engine.....	191,202
G424F(E) LP and Dual Fuel Engines	172
Gasoline and LP Engines	155
Gasoline Engine	76
Gasoline or Diesel Engine Equipped	71
Gasoline Specifications.....	140
Gasoline, LP Engine Crankcase	171
GC-Series Lift Trucks.....	196
General Fuel Information	139
General Hazard Information	10
General Warning to Operator	6
Governor Lever and Engine Speed Control (Diesel Engine Only) - Check ,Adjust	174

H

Hand Placement Warning.....	7
Hook-on type Fork.....	126
Horn and Lights (If Equipped) - Check	180
How to Survive in a Tipover	28
Hydraulic Oil - Check, Clean, Change.....	201
Hydraulic Oil (HYDO).....	141
Hydraulic Oil Level – Check.....	169
Hydraulic Return Filter – Change.....	166
Hydraulic Return Filter, Breather & Strainer - Check, Change	185

I

Identification, Lift Capacity and Attachment Plate	62
If Convenience Package Equipped.....	62
If Optional Suspension Seat (weight adjusting type) Equipped.....	18
If Parking Brake Alarm Equipped.....	125
Important Safety Information	4
Improper Modification or Repair.....	131
Inching & Braking Control Shaft - Lubricate	180
Inching into Loads.....	121
Inching.....	83
Index	205
Inspect Battery System.....	201
Inspect Coolant Hoses (LP, Dual Fuel Engine Only).....	189
Inspect Electrical System (G420F(E)/G424F(E) Engine Only).....	181
Inspect Engine for Exhaust Leaks	157
Inspect Engine for Fluid Leaks.....	155
Inspect Foot Pedal Operation (G420F(E)/G424F(E) Only).....	157
Inspect for Intake Leaks (G420F(E)/G424F(E) Engine Only).....	203
Inspect Ignition System (LP, Gasoline & Dual Fuel Engines Only).....	191
Inspect Mixer Assembly (G420F(E)/G424F(E) Engine Only).....	189
Inspect Throttle Assembly (G420F(E)/G424F(E) Engine Only).....	189
Inspect Tightness (D, G - Series).....	173
Inspect Tightness (GC - Series).....	173
Inspect Vacuum Lines and Fittings (G420F(E)/G424F(E) Engine Only)	181
Inspection from Operator's Seat, Engine OFF....	159
Inspection from Operator's Seat, Engine ON.....	159
Inspection, Maintenance and Repair of Lift Truck Forks	130
Instrument Panel	63

L

Lift Chain Adjustment.....	186
Lift Chain Wear Test	186
Lift Chains - Test, Check, Adjust.....	186

Lift Control.....	70
Lift Fork Adjustment	126
Lift Truck Controls	69
Lift Truck Operation.....	82
Lift Truck Parking.....	13
Lift Truck Shipping.....	128
Lift Truck Stability Base.....	22
Lift Truck Stability.....	21
Lifting Drums or Round Objects	124
Lifting the Load	121
Literature Information	2
Load Backrest Must Be In Place Warning	7
Long Time Storage.....	127
LP Engine.....	77
LP Regulator/Converter Inspection (LP, Dual Fuel Engine Only)	189
LP Specifications.....	140
Lubricant Information.....	141
Lubricant Viscosities and Refill Capacities.....	143
Lubricant Viscosities.....	143
Lubricating Grease (MPGM).....	142

M

Machine Lifting and Tiedown Information.....	128
Maintenance and Repair.....	133
Maintenance Information	14
Maintenance Intervals.....	3,144
Maintenance	3
Make proper antifreeze additions.....	138
Manual Mode (Fail-Safe mode).....	120
Mast Abbreviations.....	62
Mast Channels – Lubricate.....	158
Mast Hinge Pin – Lubricate.....	176
Mast Pivot Eyes-Lubricate	177
Mast, Carriage, Lift Chains & Attachments - Inspect, Lubricate.....	170
Metric Hardware	135
Mono-Ped Control System (Option).....	117
Mounting and Dismounting.....	11
Moving Fan Warning	8

N

No Riders Warning.....	8
No Standing On Fork Warning	7
No Standing Under Fork Warning.....	7
Noise and Vibration	42

O

Oil Cooled Disc Brake Only	142
Operating in hot weather.....	124
Operating Techniques.....	121
Operating the Lift Truck.....	12
Operation Information	11
Operation	2,119
Operator's Warning and Identification Plate.....	62

Operator's Warning Plate	62
Operator Restraint System(If Equipped)	2,17
Operator's Station and Monitoring Systems.....	63
Overhead Guard – Inspect	178
Overhead Guard Must Be In Place Warning.....	8
Overloading	131

P

Parking Brake - Inspect	159
Parking Brake - Test, Adjust.....	164,180
Parking Brake Adjusting	165
Parking Brake Lever	70
Parking Brake Testing	164
PARKING BRAKE.....	160
Parking brake	9
Parking the Lift Truck.....	125
PCV Valve System - Inspect, Clean.....	172
Power Shift Transmission/ Drive axle.....	82
Precleaner (If Equipped).....	167
Pressure Air.....	14
Pressure Warning	7
Prestart Conditions.....	76
Priming the Fuel System(Diesel Engine Only)....	150
Product Description.....	118

R

Reading Diagnostic Fault Codes	99
Refill Capacities.....	143
Refueling.....	71
Replace LP Fuel Filter Element (LP, Dual Fuel Engine Only).....	192
Replace Oxygen Sensor (G420F(E)/G424F(E) Engine Only).....	202
Replace PCV Valve and breather element - Change (LP, Gasoline and Dual Fuel Engines)	203
Replace Spark Plugs (G420F(E) Engine Only)	202
Replace Spark Plugs (G424F(E) LP, Dual Fuel Engine Only).....	191

S

Safety Rules	23
Safety.....	2,5
Seat Adjustment.....	18
Seat Switch System (If Equipped)	67
Seat.....	68
Seat, Hood Latch & Support Cylinder - Check, Lubricate	148
Serial Number Locations	59
Serial Number.....	59
Service Brake Pedal	69
Servicing Filter Element.....	167
Sideshift Attachment (If Equipped)	70
Specifications	30,32,34,36,38,40
Stability and Center of Gravity	21
Starting a Cold Diesel Engine	77

Index Section

Starting a Warm Diesel Engine	77
Starting From a 12 Volt External Source	78
Starting the Engine	76
Starting the Lift truck	12
Steer Suspension – Inspect.....	180
Steer Wheel Bearings - Reassemble.....	194
Steering Mechanism - Check, Lubricate.....	170
Storage Information.....	127

Water Separator (4TNV98 Diesel Engine Only) - Clean.....	184
Water Separator (Diesel Engine Only) - Check, Drain.....	152
Wheel Bolts & Nuts - Inspect.....	173
When Required	148

T

Table of Contents	1
Testing Fuel Lock-off Operation (LP Engine Only)	192
Tilt Control.....	70
Tilt Cylinders - Check, Adjust, Lubricate.....	176
Tilt Steering Column.....	68
Timing Belt [G420F(E)/G424F(E) LP, Gasoline, Dual Fuel Engine Only] - Change.....	204
Tire Inflation Information	134
Tire Inflation Pressures Adjustment.....	134
Tire Inflation	134
Tire Shipping Pressure.....	134
Tires and Wheels (D, G-Series) - Inspect, Check	154
To Operate the Lift Truck after a Long Time Storage	127
Torque for Metric Fasteners	136
Torque for Standard Bolts, Nuts, and Taperlock Studs	135
Torque for Standard Hose Clamps - Worm Drive	135
Torque Specifications.....	135
Torques for Bolts and Nuts with Standard Threads	135
Torques for Taperlock Studs.....	136
Towing Information.....	129
Traing Required To Operate or Service Warning ...	5
Transmission Inching Control Pedal	69
Transmission Oil Filter – Change.....	178
Transmission Oil Level – Check.....	159
Transmission Oil.....	142
Transmission Oil, Oil Filter & Strainer - Check, Clean, Change.....	162,186
Transportation Hints	128
Traveling With the Load	122
Turning	123

U

Universal Joint – Inspect.....	188
Unloading.....	122

W

Walk-Around Inspection - Inspect	157
Walk - Around Inspection.....	74
Warning Signs and Labels.....	17
Warning Signs and Labels.....	5