

**T40140**

**S/N 363212001  
& above**

**T40170**

**S/N 363312001  
& above**



**Bobcat**®

# **SERVICE MANUAL**

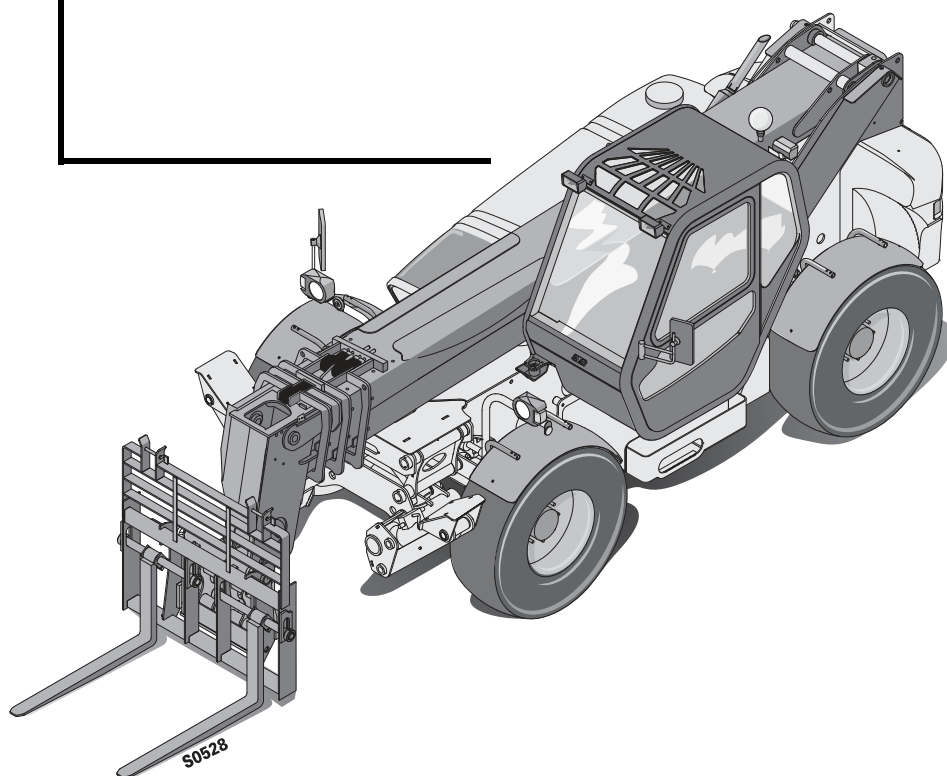



**Bobcat®**



# WARNING

Instructions are necessary before operating or servicing machine. Read and understand the Operation & Maintenance Manual, Operator's Handbook and signs (decals) on machine. Follow warnings and instructions in the manuals when making repairs, adjustments or servicing. Check for correct function after adjustments, repairs or service. Untrained operators and failure to follow instructions can cause injury or death.

W-2003-0903

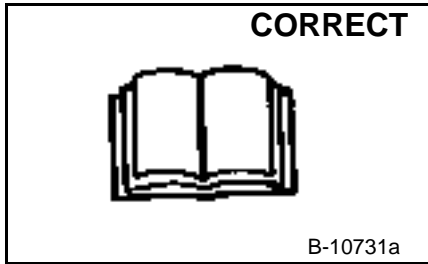

Never service the Bobcat Telescopic Handler without instructions.



**Safety Alert Symbol:** This symbol with a warning statement, means: "Warning, be alert! Your safety is involved!" Carefully read the message that follows.

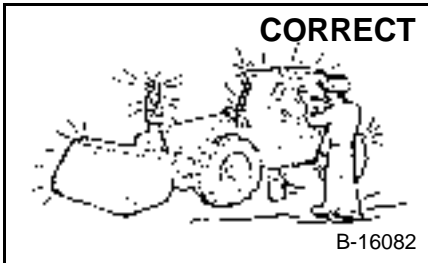

Cleaning and maintenance are required daily.

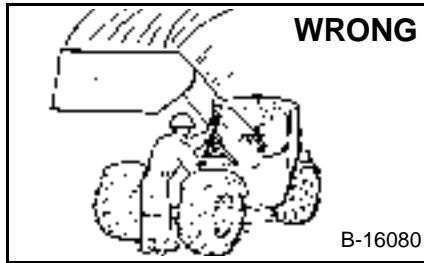

Disconnecting or loosening any hydraulic tubeline, hose, fitting, component or a part failure can cause boom to drop. Do not go under boom when raised unless supported by an approved boom stop. Replace if damaged.

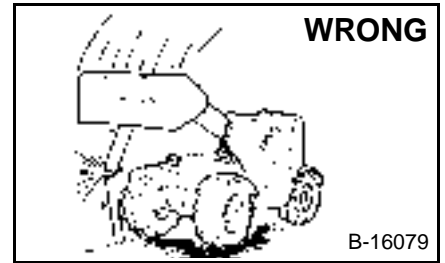

Never work on Telescopic Handler with boom up unless boom is held by an approved boom stop. Replace if damaged.  
 Never modify equipment or add attachments not approved by Bobcat Company.

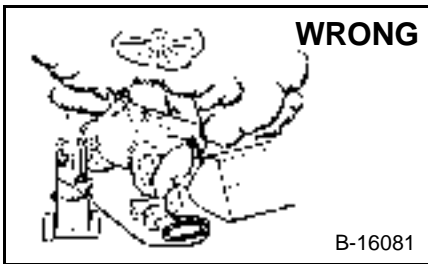

Have good ventilation when welding or grinding painted parts.  
 Wear dust mask when grinding painted parts. Toxic dust and gas can be produced.  
 Avoid exhaust fume leaks which can kill without warning. Exhaust system must be tightly sealed.

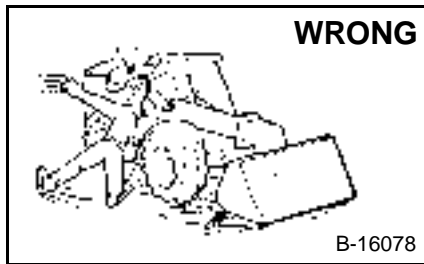

Keep body, jewelry and clothing away from moving parts, electrical contact, hot parts and exhaust.  
 Wear eye protection to guard from battery acid, compressed springs, fluids under pressure and flying debris when engines are running or tools are used. Use eye protection approved for type of welding.

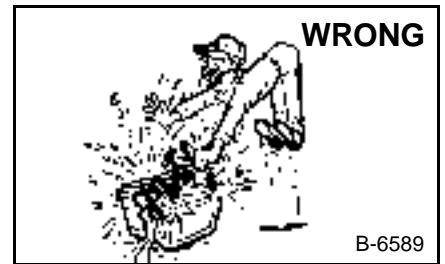

Lead-acid batteries produce flammable and explosive gases.  
 Keep arcs, sparks, flames and lighted tobacco away from batteries.  
 Batteries contain acid which burns eyes or skin on contact. Wear protective clothing. If acid contacts body, flush well with water. For eye contact flush well and get immediate medical attention.

Maintenance procedures which are given in the Operation & Maintenance Manual can be performed by the owner / operator without any specific technical training. Maintenance procedures which are **not** in the Operation & Maintenance Manual must be performed **ONLY BY QUALIFIED BOBCAT SERVICE PERSONNEL**. Always use genuine Bobcat replacement parts.

MSW12-0805



**Bobcat®**



## ALPHABETICAL INDEX

ACCUMULATOR .....	20-210	FUEL SYSTEM .....	10-80
AIR CLEANER .....	70-40	FUEL TANK .....	50-80
AIR CLEANER SERVICE .....	10-60		
AIR CONDITIONING SERVICE .....	80-90	GEAR PUMP .....	20-130
AIR CONDITIONING SYSTEM FLOW .....	80-10	GENERAL AIR CONDITIONING SERVICE GUIDELINES	80-60
AIR INTAKE COWLING .....	50-170		
ALTERNATOR .....	60-30	HEATER ASSEMBLY .....	80-170
APPROVED BOOM STOP .....	10-150	HYDRAULIC CONNECTION SPECIFICATIONSSPEC-50	
AXLE AND DIFFERENTIAL (FRONT) .....	40-20	HYDRAULIC CONTROL VALVE .....	20-170
AXLE AND DIFFERENTIAL (REAR) .....	40-21	HYDRAULIC / HYDROSTATIC FLUID SPECIFICATIONS .....	SPEC-60
AXLE TOE-IN .....	40-40	HYDRAULIC / HYDROSTATIC SYSTEM .....	10-100
AXLES (FRONT AND REAR) .....	10-110	HYDRAULIC RESERVOIR .....	20-150
		HYDRAULIC SYSTEM INFORMATION .....	20-10
BASIC TROUBLESHOOTING .....	80-50	HYDROSTATIC DRIVE MOTOR .....	30-30
BATTERY .....	60-20	HYDROSTATIC PUMP .....	30-40
BOOM ASSEMBLY .....	50-30	HYDROSTATIC SYSTEM INFORMATION .....	30-10
BOOM TRAY .....	50-160		
BRAKE LIGHT SWITCH .....	60-100	INCHING SWITCH .....	60-170
BRAKE VALVE .....	20-120	INSTRUMENT PANEL .....	60-80
BUCKET POSITIONING CYLINDER .....	20-30	INTERMEDIATE BOOM .....	50-160
		JOYSTICK .....	60-170
COMPONENTS .....	80-20	JOYSTICK PANEL .....	50-160
COMPRESSOR .....	80-110		
CONDENSER .....	80-120	LIFT CYLINDER .....	20-20
CONVERSIONS .....	SPEC-70	LIFTING AND BLOCKING THE TELESCOPIC HANDLER .....	10-10
		LIGHTS .....	60-60
DASH COVER / STEERING COLUMN COVER ...	50-130	LUBRICATION .....	10-120
DRIVE BOX .....	20-70		
DRIVESHAFT .....	40-70	MACHINE TORQUE SPECIFICATIONS .....	SPEC-30
		MAIN RELIEF VALVE .....	20-80
ELECTRICAL SYSTEM INFORMATION .....	60-10	MUFFLER .....	70-30
ENGINE AND ENGINE MOUNTS .....	70-60		
ENGINE COMPONENTS AND TESTING .....	70-70	OIL COOLER .....	30-20
ENGINE COOLING SYSTEM .....	10-70	OIL COOLER / RADIATOR .....	70-50
ENGINE COVER .....	10-160	OPERATOR CAB .....	10-20
ENGINE COVER .....	50-170	OPERATOR CAB .....	50-10
ENGINE / HYDROSTAT ASSEMBLY .....	70-80	OPERATOR SEAT .....	50-20
ENGINE LUBRICATION SYSTEM .....	10-90		
ENGINE SPECIFICATIONS .....	SPEC-20	PARKING BRAKE .....	20-190
ENGINE SPEED CONTROL .....	70-20	PARKING BRAKE .....	40-50
ENGINE TIMING .....	70-71	PEDAL ASSEMBLY .....	60-140
END BOOM .....	50-40	PORT RELIEF VALVES .....	20-171
EVAPORATOR / BLOWER UNIT .....	80-150	PRESSURE REDUCING VALVE .....	20-200
EXPANSION VALVE .....	80-160	PRESSURE SWITCH .....	80-140
EXTENSION CYLINDER .....	20-40		
		FAN MOTOR .....	20-140
FAN MOTOR .....	20-140	FENDER .....	50-110
FENDER .....	50-110	FLOW CONTROL VALVE .....	20-172
FLOW CONTROL VALVE .....	20-172	FLYWHEEL AND HOUSING .....	70-90
FLYWHEEL AND HOUSING .....	70-90	FRAME LEVELING CYLINDER .....	20-100
FRAME LEVELING CYLINDER .....	20-100	FRAME LEVEL SPEED SWITCH .....	60-170
FRAME LEVEL SPEED SWITCH .....	60-170	FRONT AXLE .....	40-30
FRONT AXLE .....	40-30	FRONT WEIGHT .....	50-120
FRONT WEIGHT .....	50-120	FRONT WIPER MOTOR .....	60-110
FRONT WIPER MOTOR .....	60-110		

---

## ALPHABETICAL INDEX (CONT'D)

QUICK TACH.....	50-90
QUICK TACH CYLINDER.....	20-90
REAR AXLE .....	40-90
REAR WEIGHTS.....	50-100
REAR WIPER MOTOR .....	60-130
RECEIVER / DRIER.....	80-130
RECONDITIONING THE ENGINE.....	70-100
REGULAR MAINTENANCE.....	80-40
SAFETY .....	80-30
SERVICE BRAKE .....	40-80
SERVICE SCHEDULE .....	10-50
SERVICE SOFTWARE .....	60-170
STABILIZER CONTROL VALVE.....	20-250
STABILIZER CYLINDER .....	20-250
STABILIZER FRAME.....	50-160
STARTER .....	60-40
STEERING ANGLE ADJUSTMENT.....	40-60
STEERING CYLINDER (FRONT) .....	20-60
STEERING CYLINDER (REAR) .....	20-61
STEERING MODE VALVE BLOCK .....	20-110
STEERING VALVE .....	20-160
SWITCH PANEL.....	60-90
SYSTEM CHARGING AND RECLAMATION .....	80-100
SYSTEM TROUBLESHOOTING CHART .....	80-70
TEMPERATURE / PRESSURE.....	80-80
TIRE MAINTENANCE .....	10-130
TILT CYLINDER .....	20-50
TOP WIPER MOTOR .....	60-120
TORQUE SPECIFICATIONS FOR BOLTS.....	SPEC-40
TOW VALVE .....	20-220
TOWING THE TELESCOPIC HANDLER.....	10-40
TRANSPORTING THE TELESCOPIC HANDLER..	10-30
TRAVEL / SIGNAL LEVER.....	60-70
TROUBLESHOOTING .....	40-10
TROUBLESHOOTING .....	70-10
TELESCOPIC HANDLER SPECIFICATIONS... SPEC-10	
WEAR PADS (FRONT) .....	50-50
WEAR PADS (REAR).....	50-60

---

## CONTENTS

FOREWORD .....	II
SAFETY INSTRUCTIONS .....	V
SERIAL NUMBER LOCATIONS .....	VIII
DELIVERY REPORT .....	IX
BOBCAT TELESCOPIC HANDLER IDENTIFICATION .....	IX
SAFETY AND MAINTENANCE .....	10-01
HYDRAULIC SYSTEM .....	20-01
HYDROSTATIC SYSTEM .....	30-01
DRIVE SYSTEM .....	40-01
MAIN FRAME .....	50-01
ELECTRICAL SYSTEM AND ANALYSIS .....	60-01
ENGINE SERVICE .....	70-01
HEATING, VENTILATION, AIR CONDITIONING .....	80-01
SPECIFICATIONS .....	SPEC-01

**SAFETY &  
MAINTENANCE**

**HYDRAULIC  
SYSTEM**

**HYDROSTATIC  
SYSTEM**

**DRIVE  
SYSTEM**

**MAIN FRAME**

**ELECTRICAL  
SYSTEM &  
ANALYSIS**

**ENGINE  
SERVICE**

**HVAC**

**SPECIFICATIONS**

# FOREWORD

This manual is for the Bobcat Telescopic Handler mechanic. It provides necessary servicing and adjustment procedures for the Bobcat Telescopic Handler and its component parts and systems. Refer to the Operation & Maintenance Manual for operating instructions, starting procedure, daily checks, etc.

A general inspection of the following items must be made after the Telescopic Handler has had service or repair:

1. Check that ROPS / FOPS (including right side window) is in good condition and is not modified.



9. Enclosure door latches must open and close freely.



2. Check that ROPS mounting hardware is tightened and is Bobcat approved.



10. Attachment locking pins must function correctly and be in good condition.



3. The seat belt must be correctly installed, functional and in good condition.



11. Safety treads must be in good condition.

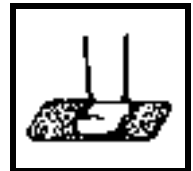

4. Check boom support device, replace if damaged.

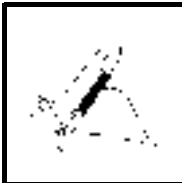

12. Check for correct function of indicator lamps and gauges.

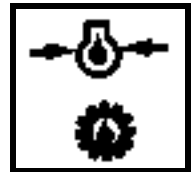

5. Machine signs must be legible and in the correct location.



13. Check hydraulic fluid level, engine oil level and fuel supply.



6. Check tires for wear and pressure. Use only approved tires.



14. Inspect for fuel, oil or hydraulic fluid leaks.

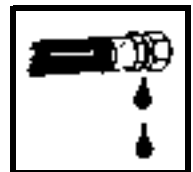

7. Check for correct function of the work lights.



15. Lubricate the Telescopic Handler



8. The parking brake must function correctly.



16. Check the condition of the battery and cables.



17. Inspect the air cleaner for damage or leaks. Check the condition of the element.



18. Check the electrical charging system.



19. Inspect for loose or broken parts or connections.



20. Operate the Telescopic Handler and check all functions.

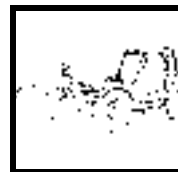

21. Check for any field modification not completed.



22. Recommend to the owner that all necessary corrections be made before the machine is returned to service.





**Bobcat®**

## SAFETY INSTRUCTIONS



### Safety Alert Symbol

This symbol with a warning statement means:  
“Warning, be alert! Your safety is involved!”  
Carefully read the message that follows.



## WARNING

Instructions are necessary before operating or servicing machine. Read and understand the Operation & Maintenance Manual, Operator's Handbook and signs (decals) on machine. Follow warnings and instructions in the manuals when making repairs, adjustments or servicing. Check for correct function after adjustments, repairs or service. Untrained operators and failure to follow instructions can cause injury or death.

W-2003-0903

## IMPORTANT

This notice identifies procedures which must be followed to avoid damage to the machine.

I-2019-0284

The signal word **DANGER** on the machine and in the manuals indicates a hazardous situation which, if not avoided, will result in death or serious injury.

D-1002-1107



## WARNING

The signal word **WARNING** on the machine and in the manuals indicates a potentially hazardous situation which, if not avoided, could result in death or serious injury.

W-2044-1107

The following publications provide information on the safe use and maintenance of the Bobcat machine and attachments:

- The Delivery Report is used to assure that complete instructions have been given to the new owner and that the machine is in safe operating condition.
- The Operation & Maintenance Manual delivered with

the machine or attachment contains operating information as well as routine maintenance and service procedures. It is a part of the machine and can be stored in a container provided on the machine. Replacement Operation & Maintenance Manuals can be ordered from your Bobcat dealer.

- Machine signs (decals) instruct on the safe operation and care of your Bobcat machine or attachment. The signs and their locations are shown in the Operation & Maintenance Manual. Replacement signs are available from your Bobcat dealer.
- The Service Manual and Parts Manual are available from your dealer for use by mechanics to do shop-type service and repair work.

The dealer and owner / operator review the recommended uses of the product when delivered. If the owner / operator will be using the machine for a different application(s) he or she must ask the dealer for recommendations on the new use.



Cutting or drilling concrete containing sand or rock containing quartz may result in exposure to silica dust.

SI VH-0308 SM

## FIRE PREVENTION



### Maintenance

The machine and some attachments have components that are at high temperatures under normal operating conditions. The primary source of high temperatures is the engine and exhaust system. The electrical system, if damaged or incorrectly maintained, can be a source of arcs or sparks.

Flammable debris (leaves, straw, etc.) must be removed regularly. If flammable debris is allowed to accumulate, it can cause a fire hazard. Clean often to avoid this accumulation. Flammable debris in the engine compartment is a potential fire hazard.

The operator's area, engine compartment and engine cooling system must be inspected every day and cleaned if necessary to prevent fire hazards and overheating.

All fuels, most lubricants and some coolants mixtures are flammable. Flammable fluids that are leaking or spilled onto hot surfaces or onto electrical components can cause a fire.

### Operation

Do not use the machine where exhaust, arcs, sparks or hot components can contact flammable material, explosive dust or gases.

### Electrical



Check all electrical wiring and connections for damage. Keep the battery terminals clean and tight. Repair or replace any damaged part or wires that are loose or frayed.

Battery gas can explode and cause serious injury. Use the procedure in the Operation & Maintenance Manual for connecting the battery and for jump starting. Do not jump start or charge a frozen or damaged battery. Keep any open flames or sparks away from batteries. Do not smoke in battery charging area.

## Hydraulic System

Check hydraulic tubes, hoses and fittings for damage and leakage. Never use open flame or bare skin to check for leaks. Hydraulic tubes and hoses must be properly routed and have adequate support and secure clamps. Tighten or replace any parts that show leakage.

Always clean fluid spills. Do not use gasoline or diesel fuel for cleaning parts. Use commercial nonflammable solvents.

### Fueling



Stop the engine and let it cool before adding fuel. No smoking! Do not refuel a machine near open flames or sparks. Fill the fuel tank outdoors.

### Starting

Do not use ether or starting fluids on any engine that has glow plugs. These starting aids can cause explosion and injure you or bystanders.

Use the procedure in the Operation & Maintenance Manual for connecting the battery and for jump starting.

SI VH-0308 SM



---

## **FIRE PREVENTION (CONT'D)**

### **Welding And Grinding**

Always clean the machine and attachment, disconnect the battery, and disconnect the wiring from the Bobcat controllers before welding. Cover rubber hoses, battery and all other flammable parts. Keep a fire extinguisher near the machine when welding.

Have good ventilation when grinding or welding painted parts. Wear dust mask when grinding painted parts. Toxic dust or gas can be produced.

Dust generated from repairing nonmetallic parts such as hoods, fenders or covers can be flammable or explosive. Repair such components in a well ventilated area away from open flames or sparks.

### **Fire Extinguishers**



Know where fire extinguishers and first aid kits are located and how to use them. Inspect the fire extinguisher and service the fire extinguisher regularly. Obey the recommendations on the instructions plate.

SI VH-0208

## SERIAL NUMBER LOCATIONS

Always use the serial number of the Telescopic Handler when requesting service information or when ordering parts. Early or later models (identification made by serial number) may use different parts, or it may be necessary to use a different procedure in doing a specific service operation.

### Telescopic Handler Serial Number

Figure 1



The front, on the right side of the chassis [Figure 1].

### Engine Serial Number

Figure 2

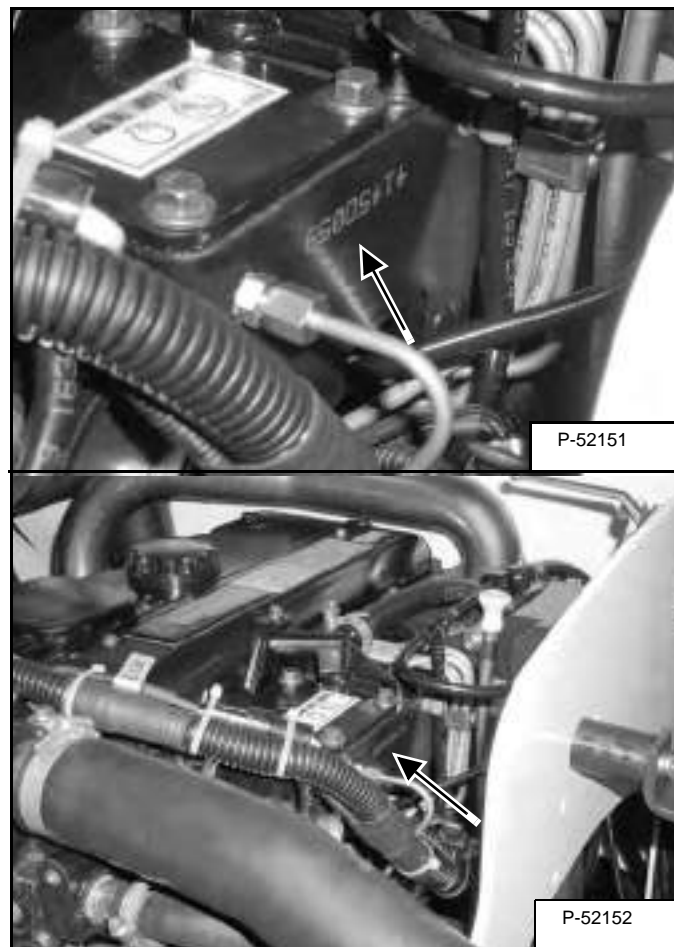

The engine serial number is stamped on a plate near the injection pump or at the rear of the cylinder block [Figure 2]. Always use the full number when ordering replacement parts.

### Other Serial Numbers

Some components may also have serial numbers. Always use these serial numbers when requesting parts.

## Delivery Report

The Delivery Report must be filled out by the dealer and signed by the owner or operator when the Telescopic Handler is delivered. An explanation of the form must be given to the owner. Make sure it is filled out completely [Figure 3].

Figure 3

The form is titled "DELIVERY REPORT" and contains several sections for data entry, including fields for vehicle identification, dealer information, and operator details. A reference number "B-16315" is located in the bottom right corner of the form area.

## Bobcat Telescopic Handler Identification

Figure 4

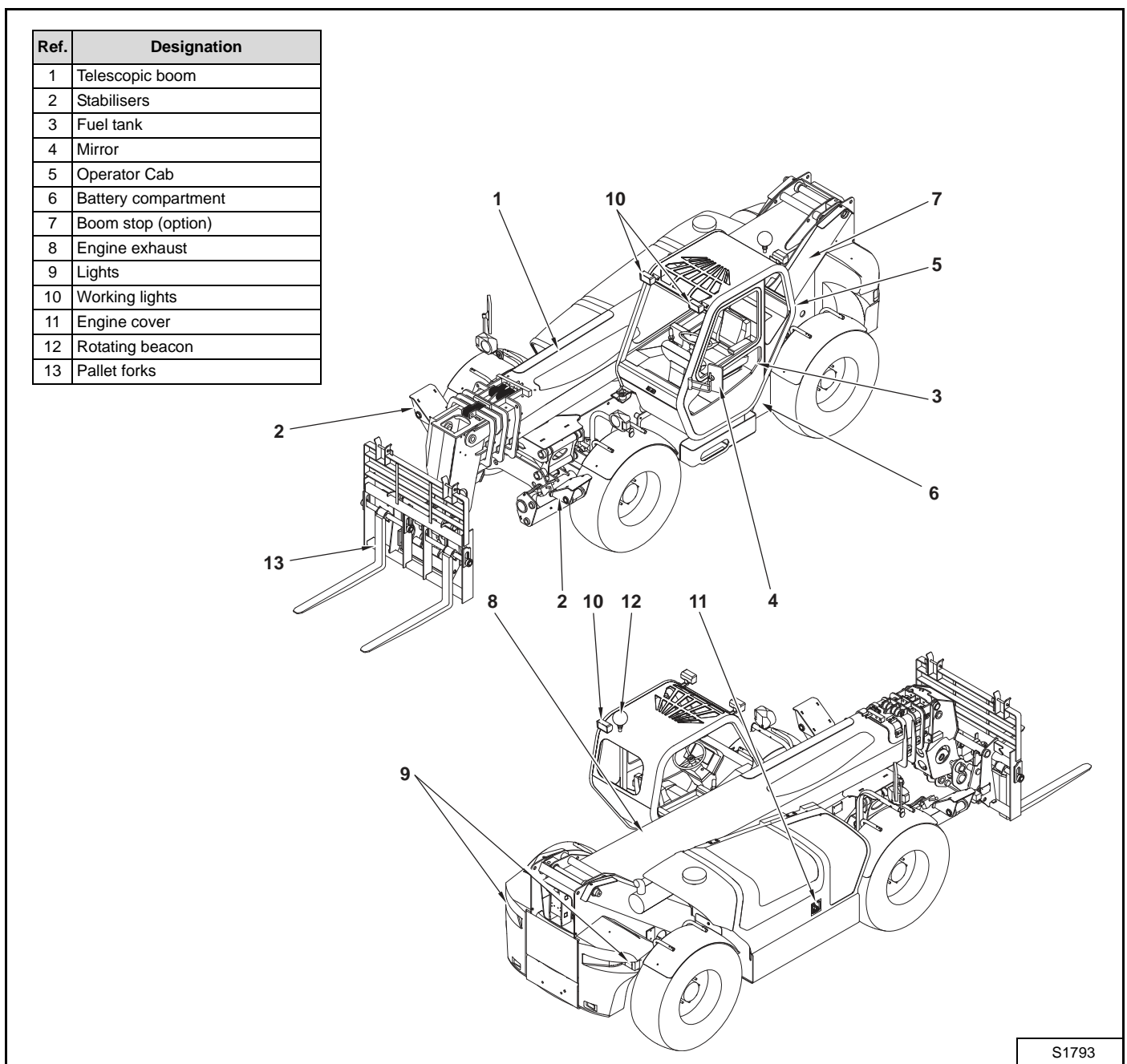



**Bobcat®**

**SAFETY AND MAINTENANCE**

AIR CLEANER SERVICE . . . . .	10-60-1
Replacing Filter Element . . . . .	10-60-1
APPROVED BOOM STOP . . . . .	10-150-1
Installing The Approved Boom Stop . . . . .	10-150-1
Removing The Approved Boom Stop . . . . .	10-150-1
AXLES (FRONT AND REAR) . . . . .	10-110-1
Checking Oil Level (Front Differential) . . . . .	10-110-2
Checking Oil Level (Planetary Carrier) . . . . .	10-110-1
Checking Oil Level (Rear Differential) . . . . .	10-110-2
Draining Oil (Front Differential) . . . . .	10-110-3
Draining Oil (Planetary Carrier) . . . . .	10-110-1
Draining Oil (Rear Differential) . . . . .	10-110-2
ENGINE COOLING SYSTEM . . . . .	10-70-1
Checking The Coolant Level . . . . .	10-70-1
Cleaning The Cooling System . . . . .	10-70-1
Replacing The Coolant . . . . .	10-70-2
ENGINE COVER . . . . .	10-160-1
Opening And Closing The Engine Cover . . . . .	10-160-1
ENGINE LUBRICATION SYSTEM . . . . .	10-90-1
Checking Engine Oil . . . . .	10-90-1
Replacing Oil And Filter . . . . .	10-90-2
FUEL SYSTEM . . . . .	10-80-1
Filling The Fuel Tank . . . . .	10-80-1
Fuel Filter . . . . .	10-80-1
Fuel Specifications . . . . .	10-80-1
HYDRAULIC / HYDROSTATIC SYSTEM . . . . .	10-100-1
Checking And Adding Fluid . . . . .	10-100-1
Replacing Hydraulic Fluid . . . . .	10-100-2
Replacing Hydraulic / Hydrostatic Filter . . . . .	10-100-1
LIFTING AND BLOCKING THE TELESCOPIC HANDLER . . . . .	10-10-1
Procedure . . . . .	10-10-1

**Continued On Next Page**

---

## SAFETY AND MAINTENANCE (CONT'D)

LUBRICATION .....	10-120-1
Procedure .....	10-120-1
OPERATOR CAB .....	10-20-1
Cab Door .....	10-20-2
Cab Door Window .....	10-20-2
Emergency Exit .....	10-20-1
SERVICE SCHEDULE .....	10-50-1
TIRE MAINTENANCE .....	10-130-1
Tire Mounting .....	10-130-1
Tire Rotation .....	10-130-1
Wheel nuts .....	10-130-1
TOWING THE TELESCOPIC HANDLER .....	10-40-1
Procedure .....	10-40-1
TRANSPORTING THE TELESCOPIC HANDLER .....	10-30-1
Procedure .....	10-30-1

## LIFTING AND BLOCKING THE TELESCOPIC HANDLER

### Procedure

Always park the machine on a level surface.

# WARNING

The seat bar system must deactivate the lift, and tilt control functions when the seat bar is up. Service the system if joysticks do not deactivate.

W-2461-0603

Figure 10-10-1

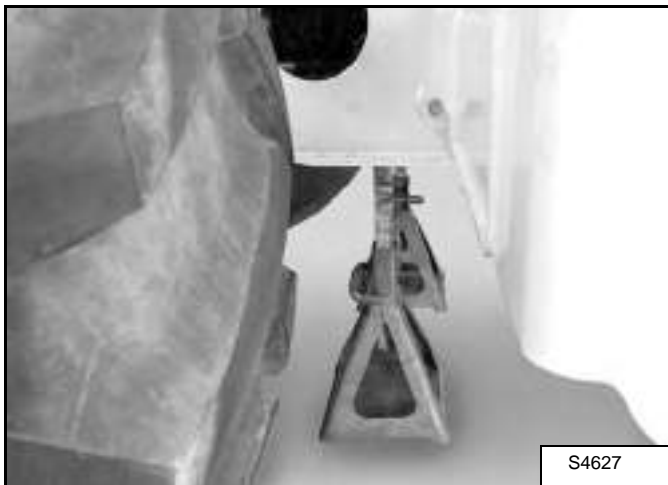

STOP the engine. Put the floor jack under the center of the front axle. Lift the Telescopic Handler and install jackstands as shown in **[Figure 10-10-1]**.

Figure 10-10-2

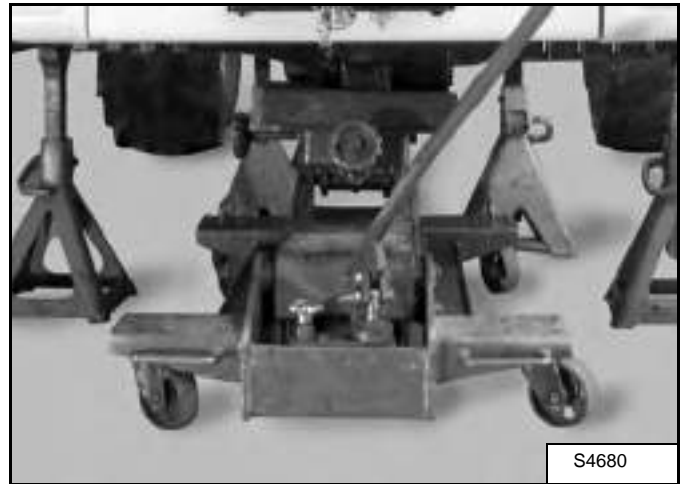

Put the floor jack under the center of the rear axle. Lift the Telescopic Handler and install jackstands **[Figure 10-10-2]**.



**Bobcat®**



## OPERATOR CAB

Figure 10-20-1

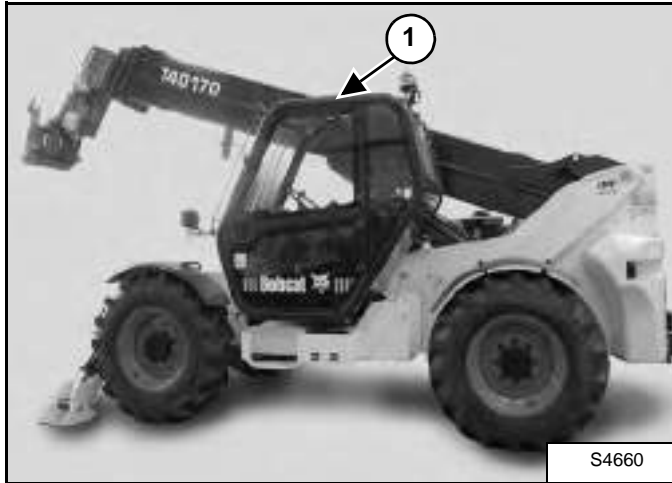

The Telescopic Handler has an operator cab (ROPS and FOPS) (Item 1) [Figure 10-20-1] to protect the operator from rollover and falling objects. Check with your dealer if the operator cab has been damaged. Never operate without right window. The seat belt must be worn for roll over protection.

ROPS / FOPS - Roll Over Protective Structure per SAE J1040 and ISO 3471, and Falling Object Protective Structure per SAE J1043 and ISO 3449 (FOPS Level II).

## WARNING

Never modify operator cab by welding, grinding, drilling holes or adding attachments unless instructed to do so by Bobcat. Do not operate without right window. Changes to the cab can cause loss of operator protection from rollover and falling objects, and result in serious injury or death.

## Emergency Exit

Figure 10-20-2

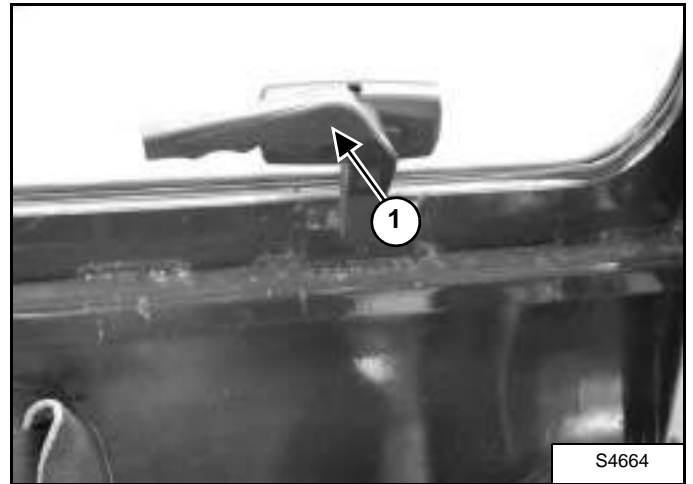

Turn the handle (Item 1) [Figure 10-20-2] and push the rear window open. (Models with enclosed cab only.) Exit through the rear window opening.

## OPERATOR CAB (CONT'D)

### Cab Door

Figure 10-20-3

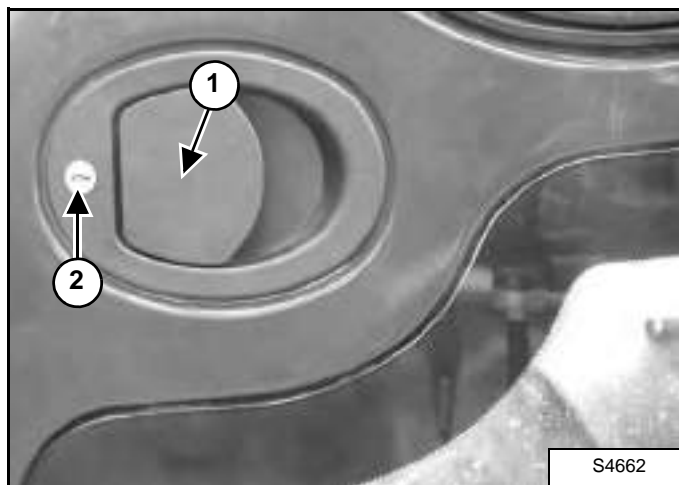
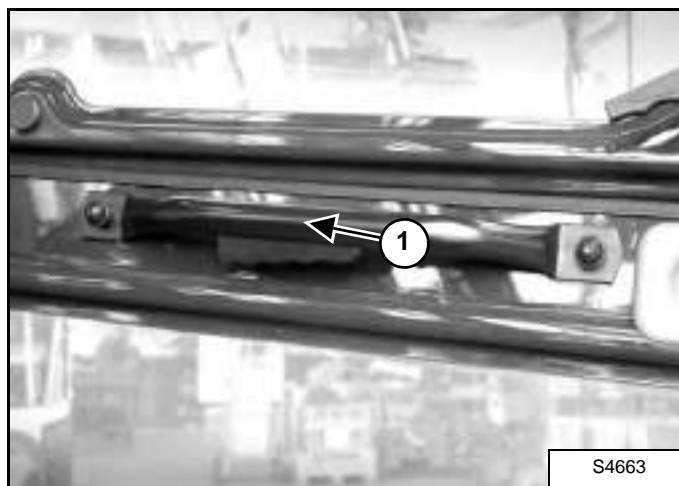

Figure 10-20-4



The cab door can be opened from the outside of the cab using the latch (Item 1) [Figure 10-20-3] and open from the inside of the cab when you squeeze the latch (Item 1) [Figure 10-20-4] (as shown).

The cab door can be locked (Item 2) [Figure 10-20-3] with the start key.

### Cab Door Window

Figure 10-20-5

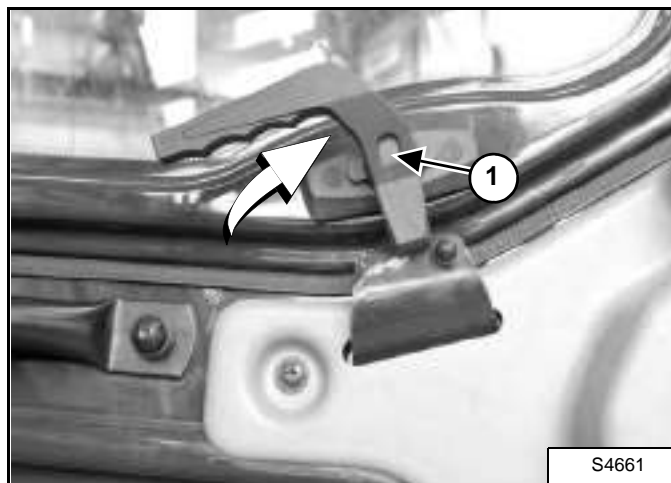

Turn the handle (Item 1) [Figure 10-20-5] (as shown). Push open the window fully until it latches against the cab.

Figure 10-20-6

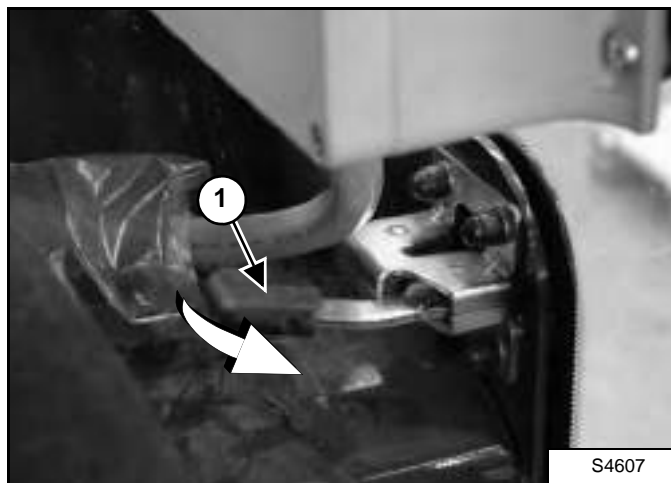

Pull the lever (Item 1) [Figure 10-20-6] inside the cab to disengage the latch and close the window.

## TRANSPORTING THE TELESCOPIC HANDLER

### Procedure

Always drive the Telescopic Handler backwards (heavy end up) onto the transport vehicle.

Figure 10-30-1

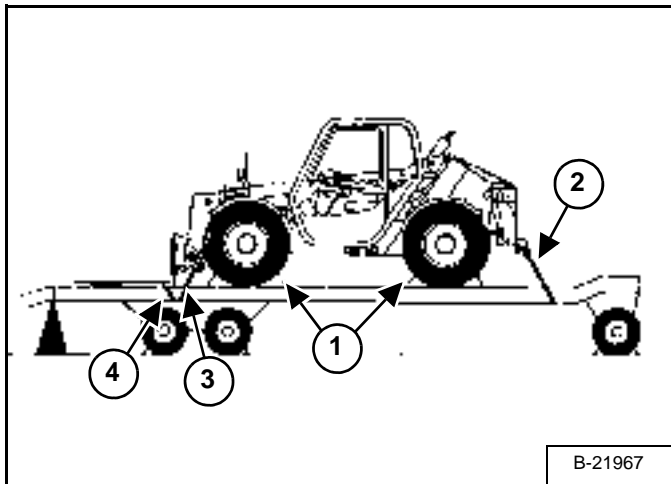

The rear of the trailer must be blocked or supported [Figure 10-30-1] when loading or unloading the Telescopic Handler to prevent the front end of the trailer from raising up.

Be sure the transport and towing vehicles are of adequate size and capacity. (See "Performance Specifications" on page SPEC-10-2 for weight of the Telescopic Handler).

Fasten the Telescopic Handler to the transport vehicle to prevent it from moving during sudden stops or when going up or down slopes.

- Block the wheels (Item 1) [Figure 10-30-1].
- Fasten the machine frame to the transport vehicle (Items 2 & 3) [Figure 10-30-1].
- Attach the forks or bucket attachment to the transport vehicle (Item 4) [Figure 10-30-1].

## WARNING

### AVOID SERIOUS INJURY OR DEATH

Adequately designed ramps of sufficient strength are needed to support the weight of the machine when loading onto a transport vehicle. Wood ramps can break and cause personal injury.

W-2058-0807



**Bobcat®**

## TOWING THE TELESCOPIC HANDLER

### Procedure

The Telescopic Handler can be towed a short distance such as removing it from mud or loading onto a transport vehicle.

Figure 10-40-1

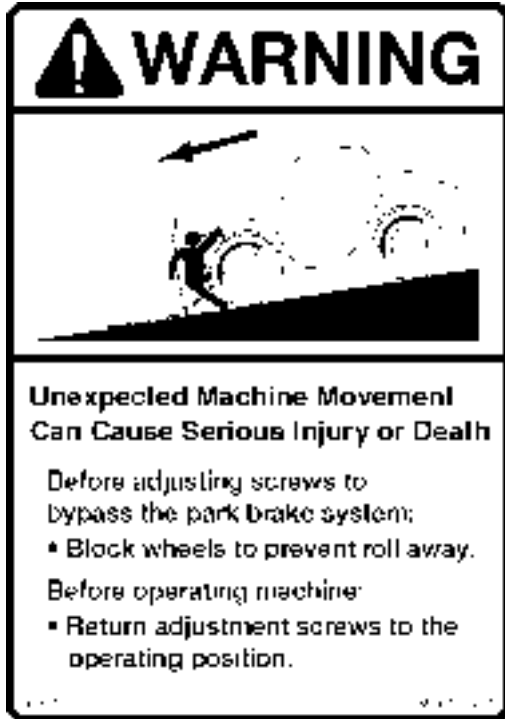

Block the wheels to prevent the machine from rolling.

### Releasing The Park Brake

The brakes are engaged by spring pressure and released by hydraulic pressure. The park brake must be released manually before towing. Only the front axle has brakes.

The following procedure describes how to release the brakes:

Figure 10-40-2

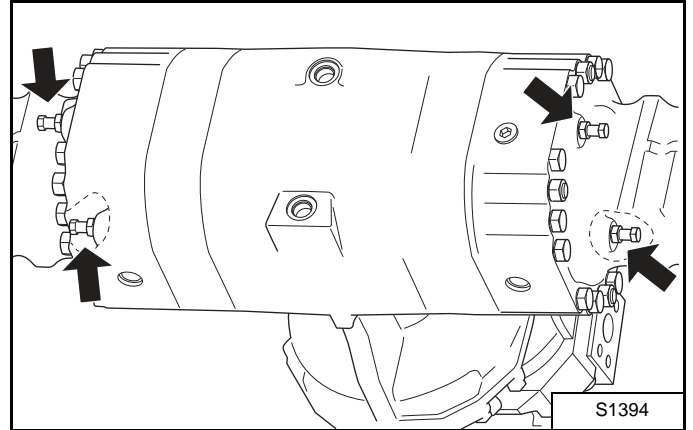
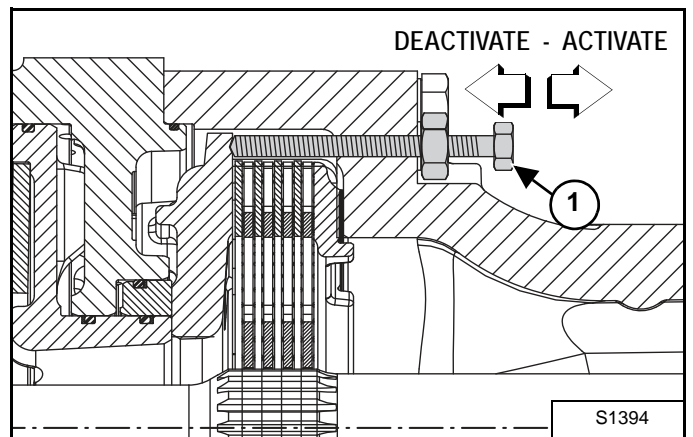

Figure 10-40-3



At each end of the central part of the front axle are two bolts (see [Figure 10-40-2] & (Item 1) [Figure 10-40-3]). When screwed in, these bolts will remove the spring pressure that engages the brake disks. [Figure 10-40-3] shows the function of such a bolt inside the axle.

The work will first be carried out on the two bolts on one side of the front axle then the two bolts on the other side:

1. Loosen the locking nuts of the bolts and create some clearance for the bolts.
2. Turn the two bolts (Item 1) [Figure 10-40-3] IN, 1/4 turn at a time, alternating between the two bolts until the bolts are firmly seated.
3. Repeat this on the two opposite side bolts on the front axle.

The brakes are now released for towing the vehicle.

Please note that the vehicle will not be able to brake until the bolts are returned to their original position.

## TOWING THE TELESCOPIC HANDLER (CONT'D)

Figure 10-40-4

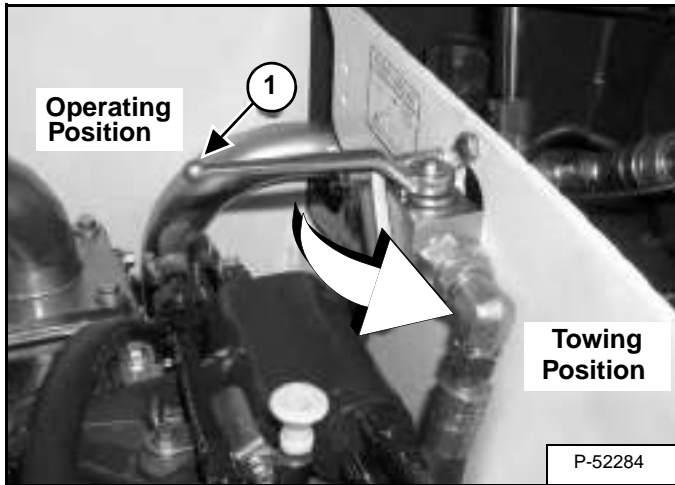

Raise the engine cover.

Turn the tow valve counterclockwise 90° (Item 1) **[Figure 10-40-4]** to TOWING POSITION.

Tow the Telescopic Handler at a slow speed.

*Engaging Brake Disks:*

Figure 10-40-5

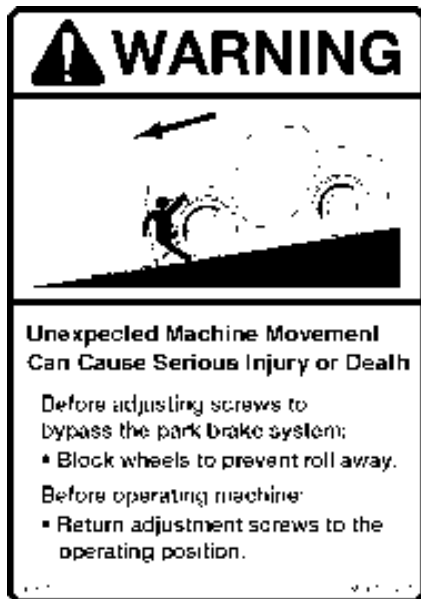

Block the wheels to prevent the machine from rolling.

After towing is completed, turn the tow valve (Item 1) **[Figure 10-40-4]** clockwise 90° to the OPERATING POSITION.

Figure 10-40-6

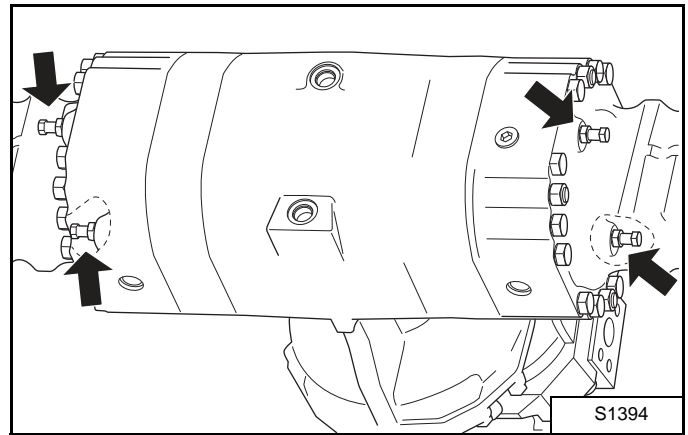

To reactivate the park brake, release the four bolts **[Figure 10-40-6]** on the front axle to their original position (turn the two bolts out, 1/4 turn at a time, until no resistance can be felt. Repeat this procedure for the opposite side two bolts).

Make sure that all four bolts have been turned out until they can easily be loosened by hand. Tighten the locking nuts.

This will allow the park brake piston to be active again.

## SERVICE SCHEDULE

Maintenance work must be done at regular intervals. Failure to do so will result in excessive wear and early failures. The service schedule is a guide for correct maintenance of the Bobcat Telescopic Handler.



# WARNING

Instructions are necessary before operating or servicing machine. Read and understand the Operation & Maintenance Manual, Handbook and signs (decals) on machine. Follow warnings and instructions in the manuals when making repairs, adjustments or servicing. Check for correct function after adjustments, repairs or service. Untrained operators and failure to follow instructions can cause injury or death.

W-2003-0199

OPERATION	PAGE	HOURS					
		10	50	200	500	800 (4)	1000 (5)
Diesel engine							
Replacement of the outer filter element	See Page 10-60-1						
Replacement of the inner filter element	See Page 10-60-1						
Checking the coolant level	See Page 10-70-1						
Checking the engine oil level	See Page 10-90-1						
Replacing the lubricating oil	See Page 10-90-2						
Replacing the oil filter	See Page 10-90-2						
Replacing the fuel filter cartridge (7)	See Page 10-80-1						
Hydraulic system							
Checking the fluid level	See Page 10-100-1						
Replacing hydraulic fluid	See Page 10-100-2						
Replacing the hydraulic / hydrostatic filter cartridge	See Page 10-100-1						
Mechanical transmission							
Checking the state of tires (rotation)	See Page 10-130-1						
Checking the tightness of wheel nuts (1)	See Page 10-130-1						
Lubricating the rear axle rolling element bearings	See Page 10-120-1						
Lubricating the axle steering pivots	See Page 10-120-1						
Checking the oil level in the front axle central casing	See Page 10-110-2			monthly			
Checking the oil level in the rear axle central casing	See Page 10-110-2			monthly			
Checking the oil level on both axles gear reducers	See Page 10-110-1						
Draining and changing the oil in the front axle central casing (3)	See Page 10-110-3						
Draining and changing the oil on the rear axle central casing (3)	See Page 10-110-2						
Draining and changing the oil on two axles gear reducers (3)	See Page 10-110-1						
Structure							
Lubricating the hinge pins	See Page 10-120-1						
Electrical system							
Checking the battery fluid level	See Page 60-10-1						
Checking the state of fuses, diodes and relays	See Page 60-10-1						
Checking the working order of controls, lighting and signalling	See Page 60-10-2						
Checking the state of electric connections	See Page 60-10-2						

- (1) Check wheel nut torque every 8 hours for the first 24 hours.
- (2) First maintenance after 50 hours then according to the table.
- (3) Replace the first time after 100 hrs, then according to the table.
- (4) Or every 12 months.
- (5) Or every 12 months.
- (6) Frequency may vary in certain dusty environments.
- (7) To be replaced after 250 hours if the fuel filter bowl is badly fouled.



**Bobcat®**



## AIR CLEANER SERVICE

### Replacing Filter Element

Figure 10-60-1

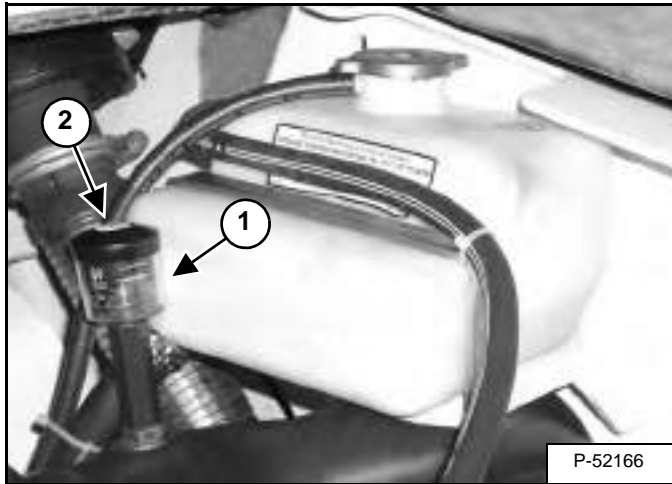

Replace the large (outer) filter element only when the red ring shows in the window of the condition indicator (Item 1) [Figure 10-60-1].

**NOTE:** Before replacing the filter element, push the button on the condition indicator (Item 2) [Figure 10-60-1]. Start the engine. If the red ring does not show, do not replace the filter element.

Replace the inner filter every third time the outer filter is replaced or when the red ring still shows in the indicator window after the outer filter has been replaced.

Figure 10-60-2

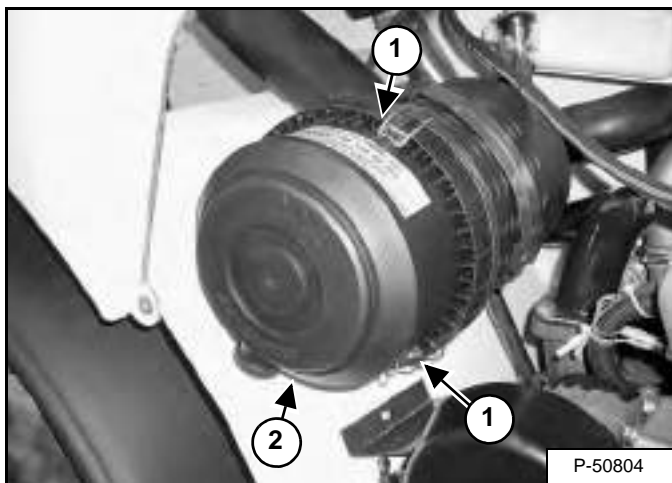

Loosen the filter housing clamps (Item 1) [Figure 10-60-2].

Release the fastener and remove the cover (Item 2) [Figure 10-60-2].

Figure 10-60-3

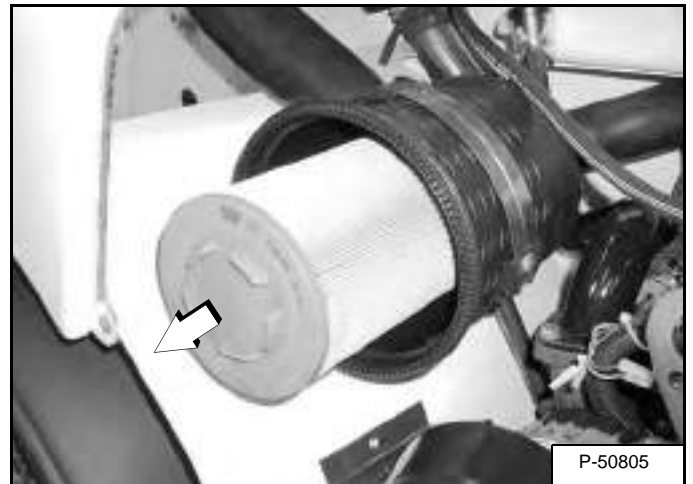

Pull the element straight out [Figure 10-60-3].

**NOTE:** Make sure all sealing surfaces are free of dirt and debris.

Install a new outer element.

Install the dust cover and fasten [Figure 10-60-3].

Connect the filter housing clamps.

---

## AIR CLEANER SERVICE (CONT'D)

### Replacing Filter Element (Cont'd)

#### *Inner Filter*

Remove the outer element.

**NOTE: Make sure all sealing surfaces are free of dirt and debris.**

**Figure 10-60-4**

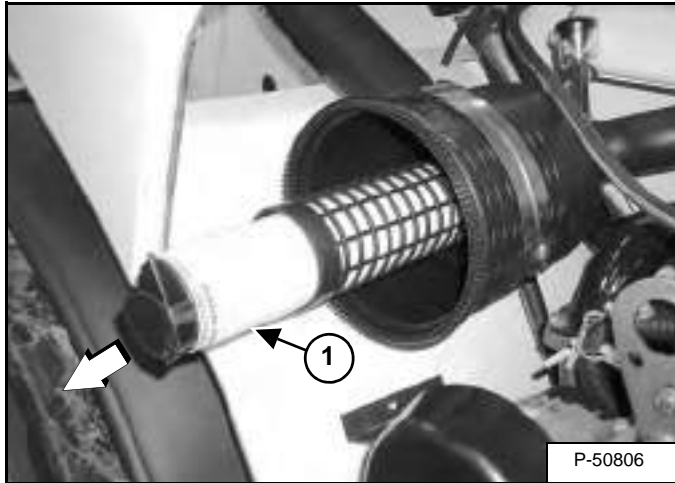

Remove the inner filter (Item 1) **[Figure 10-60-4]** and install a new element.

Install the outer element.

Install the dust cover and fasten **[Figure 10-60-4]**.

Connect the filter housing clamp (Item 1) **[Figure 10-60-4]**.

## ENGINE COOLING SYSTEM

Check the cooling system every day to prevent overheating, loss of performance or engine damage.

### **WARNING**

Wear safety glasses to prevent eye injury when any of the following conditions exist:

- When fluids are under pressure.
- Flying debris or loose material is present.
- Engine is running.
- Tools are being used.

W-2019-1285

## Cleaning The Cooling System

Figure 10-70-1

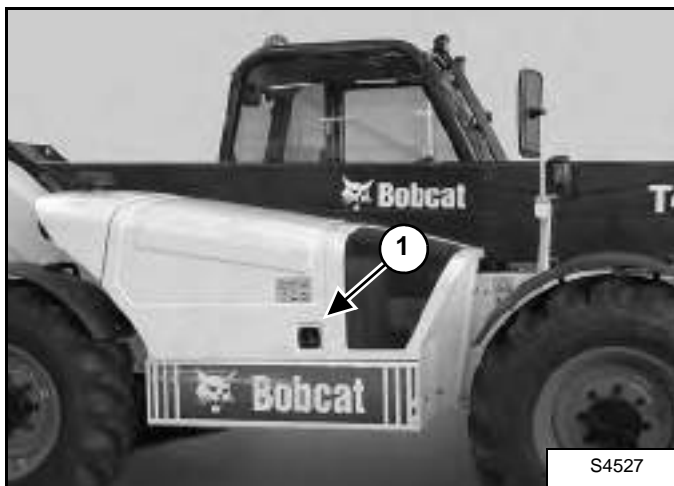

Open the engine cover (Item 1) [Figure 10-70-1].

Figure 10-70-2

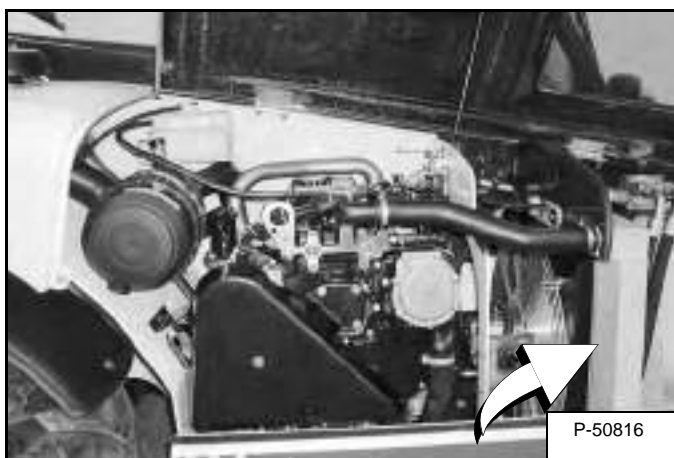

Use low air pressure or water pressure to clean the radiator and oil cooler [Figure 10-70-2].

## Checking The Coolant Level

Open the engine cover.

Check the coolant level in the coolant reservoir.

Figure 10-70-3

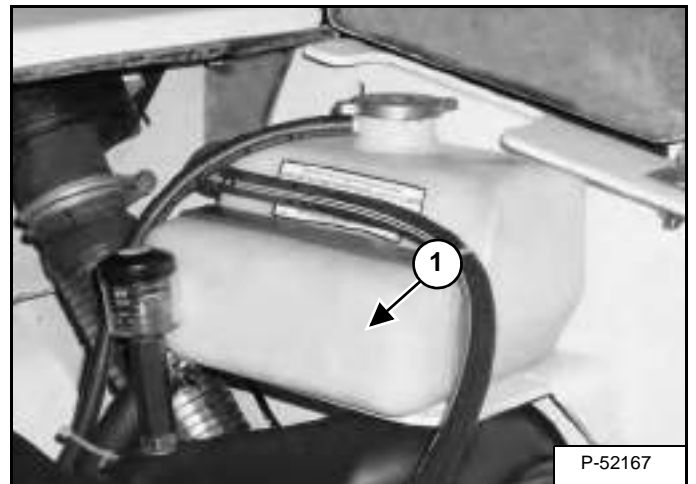

The coolant level must be between the MIN and MAX marks (Item 1) [Figure 10-70-3] on the coolant reservoir when the engine is cold.

Close the engine cover.

## IMPORTANT

### AVOID ENGINE DAMAGE

Always use the correct ratio of water to antifreeze.

Too much antifreeze reduces cooling system efficiency and may cause serious premature engine damage.

Too little antifreeze reduces the additives which protect the internal engine components; reduces the boiling point and freeze protection of the system.

Always add a premixed solution. Adding full strength concentrated coolant can cause serious premature engine damage.

I-2124-0497

## ENGINE COOLING SYSTEM (CONT'D)

### Replacing The Coolant

# ! WARNING

#### AVOID BURNS

Do not remove radiator cap when the engine is hot. You can be seriously burned.

W-2070-1203

Open the engine cover.

Figure 10-70-4

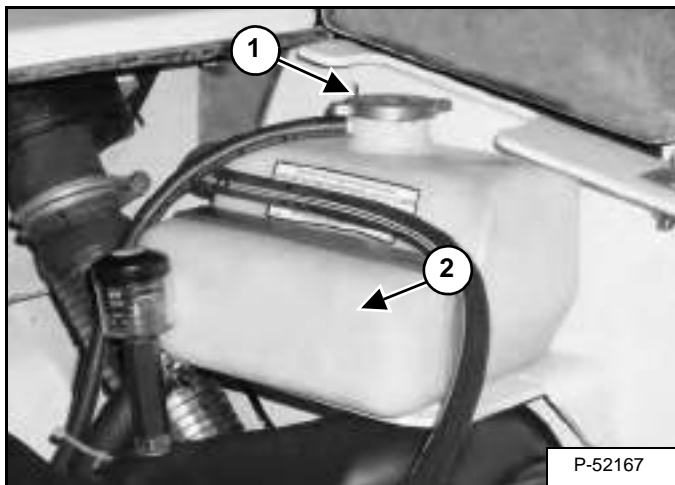

Remove the cap (Item 1) [Figure 10-70-4] from the coolant reservoir.

Remove the fan shield.

# IMPORTANT

#### AVOID ENGINE DAMAGE

Always use the correct ratio of water to antifreeze.

Too much antifreeze reduces cooling system efficiency and may cause serious premature engine damage.

Too little antifreeze reduces the additives which protect the internal engine components; reduces the boiling point and freeze protection of the system.

Always add a premixed solution. Adding full strength concentrated coolant can cause serious premature engine damage.

I-2124-0497

Figure 10-70-5

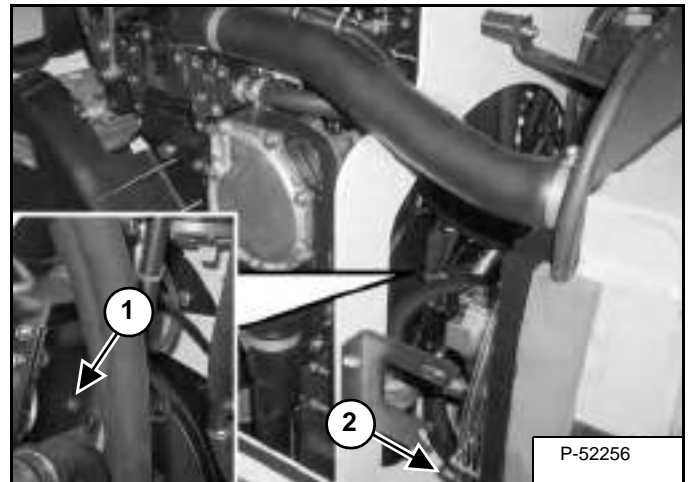

Remove the engine block drain plug (Item 1) [Figure 10-70-5].

Open the drain valve (Item 2) [Figure 10-70-5] and drain all of the coolant into a container. Dispose of used coolant in an environmentally safe manner.

Close the drain valve.

Mix the coolant in a separate container.

**NOTE: The Telescopic Handler is factory filled with ethylene glycol coolant.**

Add premixed coolant, 50% water and 50% ethylene glycol to the reservoir if the coolant level is low.

One gallon (3,8 L) of ethylene glycol mixed with one gallon (3,8 L) of water is the correct mixture of coolant to provide a -34 °F (-37 °C) freeze protection.

Use a refractometer to check the condition of ethylene glycol in your cooling system.

Fill the radiator with the premixed coolant. Install the radiator cap.

Add coolant to the reservoir. The coolant level must be between the MIN and MAX marks (Item 2) [Figure 10-70-4] on the coolant reservoir.

Run the engine until it is at operating temperature.

Stop the engine.

Check the coolant level (cold) in the reservoir when cool.

Add coolant as needed.

## FUEL SYSTEM

### Fuel Specifications

Use only clean, high quality diesel fuel, Grade No. 2 or Grade No. 1.

The following is one suggested blending guideline which should prevent fuel gelling problems in cold temperatures:

TEMP. °F (°C)	NO. 2	NO. 1
+15° (9°)	100%	0%
Down to -20° (-29°)	50%	50%
Below -20° (-29°)	0%	100%

See your fuel supplier for local recommendations.

### Filling The Fuel Tank

## WARNING

Stop and cool the engine before adding fuel. **NO SMOKING!** Failure to obey warnings can cause an explosion or fire.

W-2063-0887

Figure 10-80-1

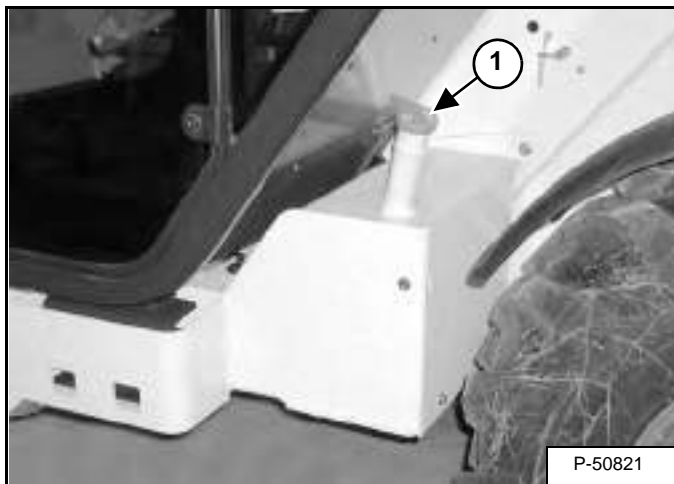

Remove the fuel fill cap (Item 1) [Figure 10-80-1].

Use a clean, approved safety container to add fuel of the correct specifications. Add fuel only in an area that has free movement of air and no open flames or sparks. **NO SMOKING!**

Install and tighten the fuel fill cap [Figure 10-80-1].

### Fuel Filter

See “SERVICE SCHEDULE” on page 10-50-1 for the service interval when to clean the sediment bowl.

Figure 10-80-2

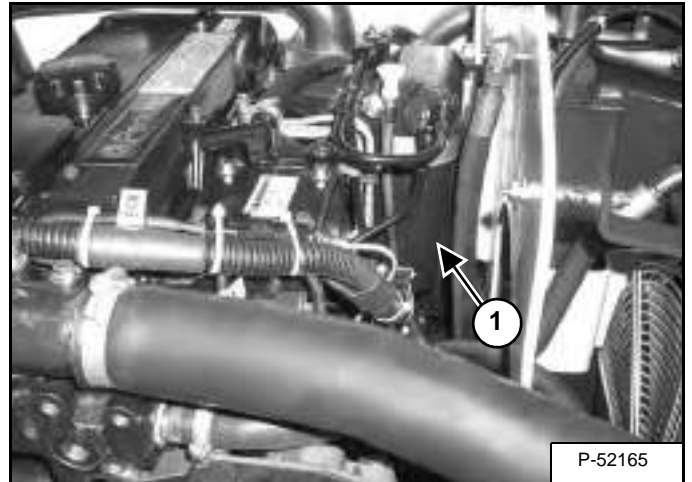

See “SERVICE SCHEDULE” on page 10-50-1 for the service interval when to replace the fuel filter.

Remove the filter element (Item 1) [Figure 10-80-2].

Clean the area around the filter housing.

Put oil on the seal of the new filter element.

Install the fuel filter, and hand tighten.

## WARNING

Always clean up spilled fuel or oil. Keep heat, flames, sparks or lighted tobacco away from fuel and oil. Failure to use care around combustibles can cause explosion or fire which can result in injury or death.

W-2103-1285



**Bobcat®**

## ENGINE LUBRICATION SYSTEM

### Checking Engine Oil

Check the engine oil level every day before starting the engine for the work shift

Figure 10-90-1

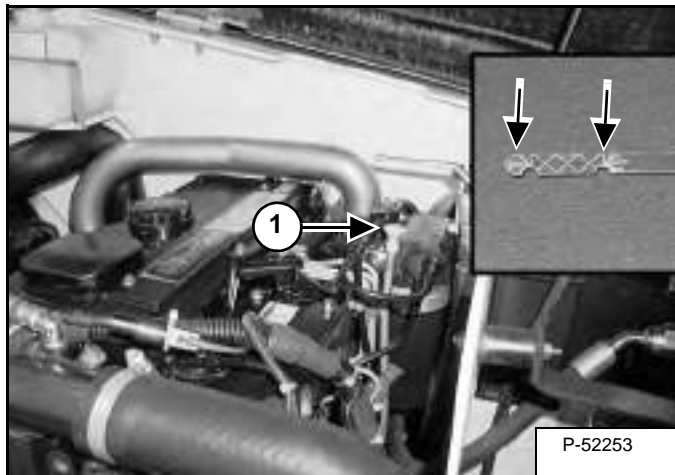

Open the engine cover and remove the dipstick (Item 1) [Figure 10-90-1].

Keep the oil level between the marks on the dipstick (Inset) [Figure 10-90-1].

Use a good quality motor oil that meets API Service Classification of CD or better. (See Oil Chart, [Figure 10-90-2].)

## Oil Chart

Figure 10-90-2

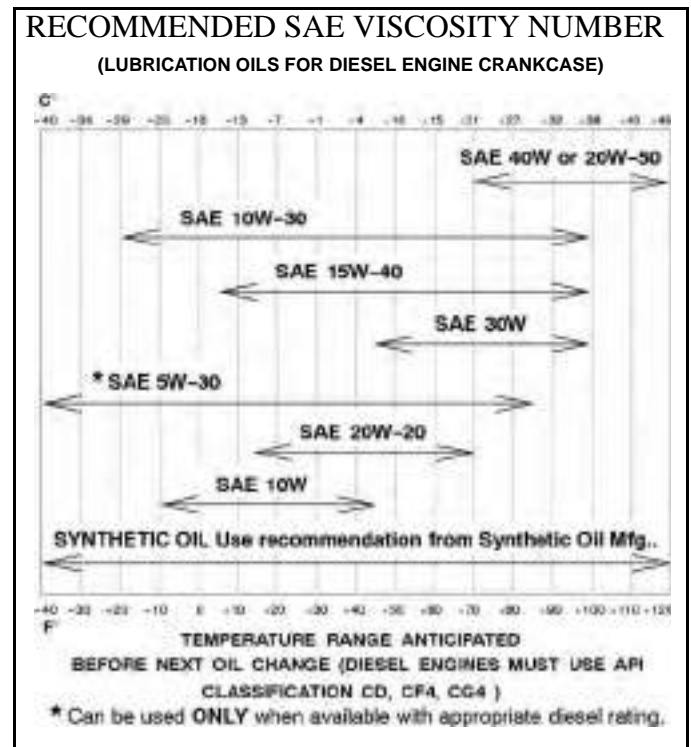

## ENGINE LUBRICATION SYSTEM (CONT'D)

### Replacing Oil And Filter

See "SERVICE SCHEDULE" on page 10-50-1 for the service interval for replacing the engine oil and filter.

Run the engine until it is at operating temperature. Stop the engine.

Figure 10-90-3

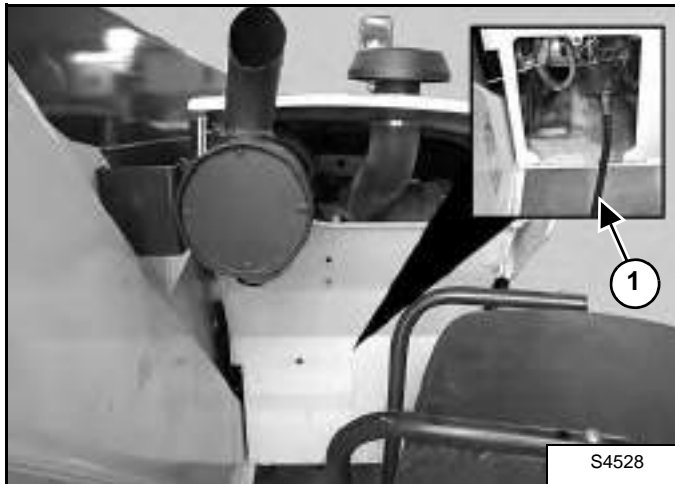

Remove the access panel at the rear of the engine compartment. Route the hose (Item 1) [Figure 10-90-3] out through the access hole. Remove the cap.

Drain the oil into a container and recycle or dispose of used oil in an environmentally safe manner.

Install cap and put the drain hose into the engine compartment, install the access cover.

## **WARNING**

Always clean up spilled fuel or oil. Keep heat, flames, sparks or lighted tobacco away from fuel and oil. Failure to use care around combustibles can cause explosion or fire which can result in injury or death.

W-2103-1285

Figure 10-90-4

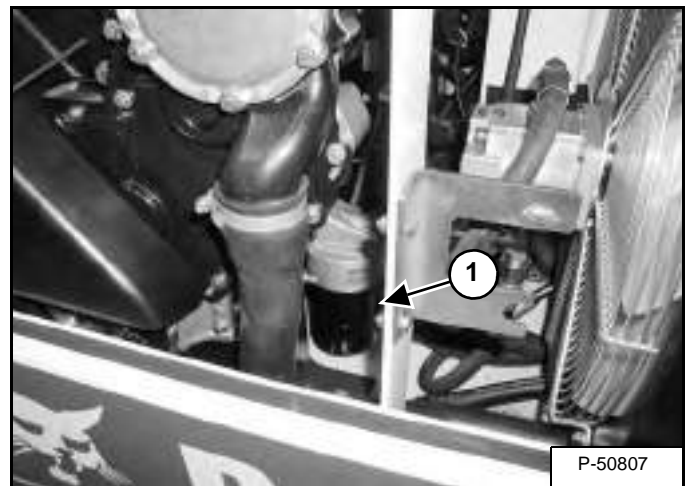

Open the engine cover.

Remove the oil filter (Item 1) [Figure 10-90-4].

Clean the filter housing surface.

Put clean oil on the new oil filter gasket. Install the filter and hand tighten.

Figure 10-90-5

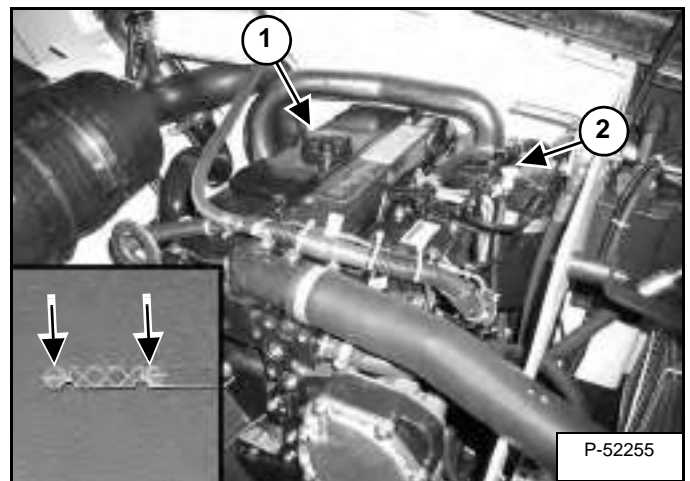

Remove the filler cap (Item 1) [Figure 10-90-5].

Put oil in the engine. (See "Capacities" on page SPEC-10-3).

Install fill cap, start the engine and let it run for several minutes.

Stop the engine, and check for leaks at the oil filter.

Remove the dipstick (Item 2) [Figure 10-90-5] and check the oil level. Add oil as needed if it is not at the top mark on the dipstick.



## HYDRAULIC / HYDROSTATIC SYSTEM

### Checking And Adding Fluid

Use only recommended fluid in the hydraulic system (See "HYDRAULIC / HYDROSTATIC FLUID SPECIFICATIONS" on page SPEC-60-1).

Stop the machine on a level surface. Lower the boom all the way.

Stop the engine.

**Figure 10-100-1**

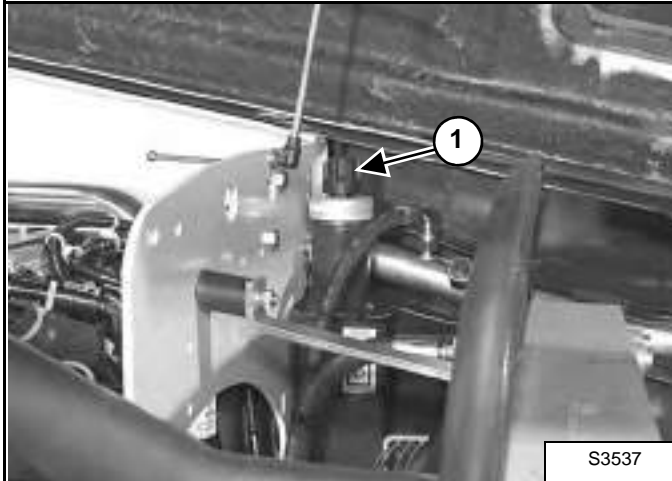

Check the fluid level at the sight gauge (Item 1) [Figure 10-100-1].

Remove the fill / breather cap (Item 1) [Figure 10-100-1] and add hydraulic fluid.

### Replacing Hydraulic / Hydrostatic Filter

Replacing Hydraulic / Hydrostatic Filter (See "SERVICE SCHEDULE" on page 10-50-1) for the correct service intervals.

Open the engine cover and remove the fill cap (Item 2) [Figure 10-100-1].

**Figure 10-100-2**

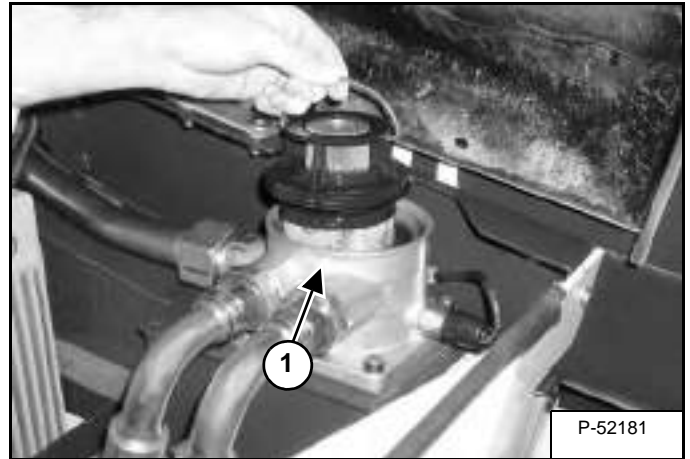

Remove the filter element (Item 1) [Figure 10-100-2].

Clean the surface of the filter housing where the seal contacts the housing.

Put clean oil on the seal of the new filter element.

Install and hand tighten the filter element.

## HYDRAULIC / HYDROSTATIC SYSTEM (CONT'D)

### Replacing Hydraulic / Hydrostatic Filter (Cont'd)

# WARNING

Diesel fuel or hydraulic fluid under pressure can penetrate skin or eyes, causing serious injury or death. Fluid leaks under pressure may not be visible. Use a piece of cardboard or wood to find leaks. Do not use your bare hand. Wear safety goggles. If fluid enters skin or eyes, get immediate medical attention from a physician familiar with this injury.

W-2072-0496

# WARNING

Always clean up spilled fuel or oil. Keep heat, flames, sparks or lighted tobacco away from fuel and oil. Failure to use care around combustibles can cause explosion or fire which can result in injury or death.

W-2103-1285

### Replacing Hydraulic Fluid

Figure 10-100-3

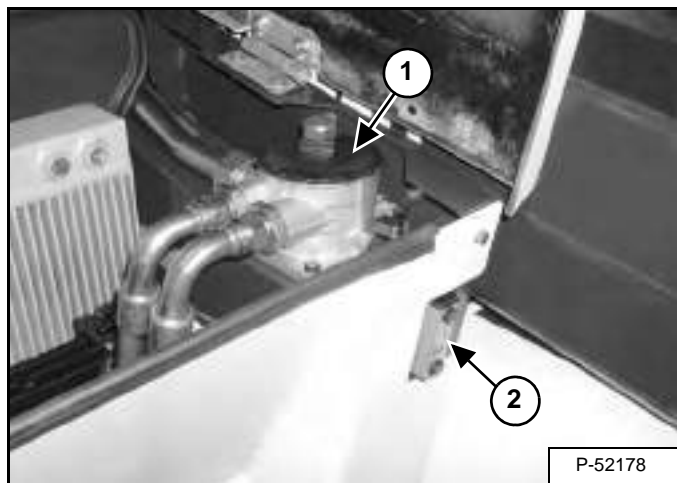

Remove the fill cap (Item 1) [Figure 10-100-3].

Figure 10-100-4

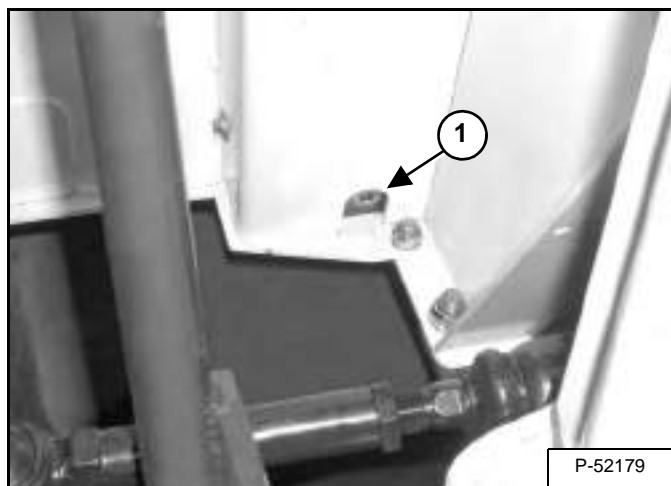

Remove the reservoir drain plug (Item 1) [Figure 10-100-4] behind the right front wheel and drain the fluid into a container. Recycle or dispose of the fluid in an environmentally safe manner. Reinstall the drain plug and tighten.

Add fluid until it is at the center of the sight gauge (Item 2) [Figure 10-100-3].

Install the fill cap.

## AXLES (FRONT AND REAR)

### Checking Oil Level (Planetary Carrier)

Figure 10-110-1

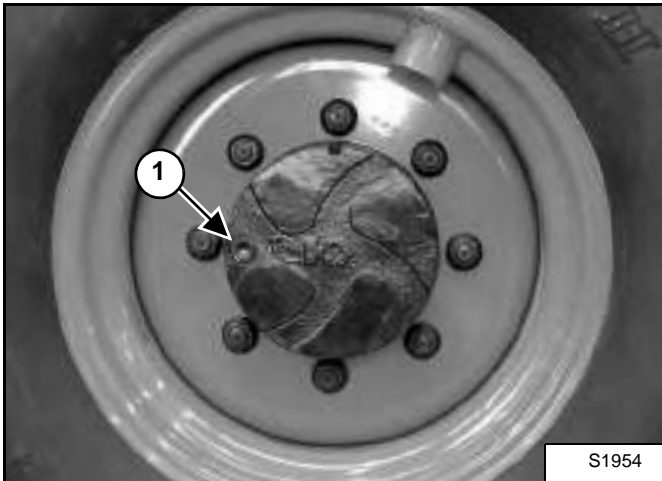

Put the machine on a level surface with the plug (Item 1) [Figure 10-110-1] positioned as shown.

Remove the plug (Item 1) [Figure 10-110-1]. The oil level should be at the bottom edge of the plug hole.

Add gear lube through the hole if the oil level is below the hole. (See "Capacities" on page SPEC-10-3 for capacity and type.)

Install and tighten the plug.

Repeat the procedure for the other side.

### Draining Oil (Planetary Carrier)

See "SERVICE SCHEDULE" on page 10-50-1 for the correct service interval.

Figure 10-110-2

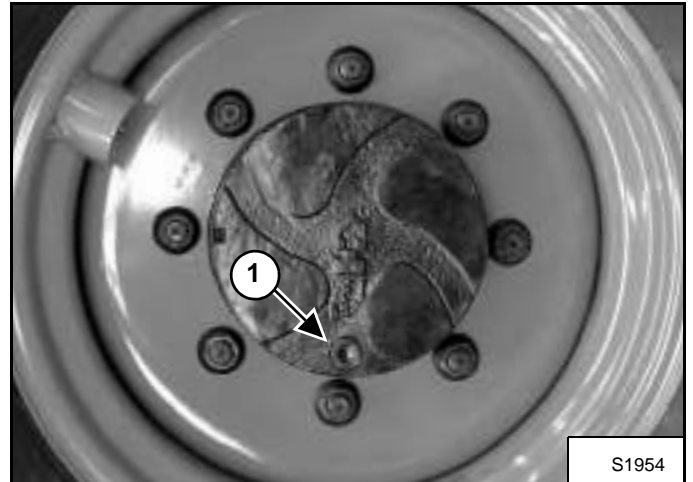

Put the machine on a level surface with the plug (Item 1) [Figure 10-110-2] positioned as shown.

Remove the plug (Item 1) [Figure 10-110-2] and drain into a container. Recycle or dispose of the used lubricant in an environmentally safe manner.

Reposition the plug hole and add gear lube until the lube level is at the bottom edge of the plug hole (Item 1) [Figure 10-110-1]. (See "Capacities" on page SPEC-10-3 for capacity and type.)

Install and tighten the plug.

Repeat the procedure for the other side.

## AXLES (FRONT AND REAR) (CONT'D)

### Checking Oil Level (Rear Differential)

Figure 10-110-3

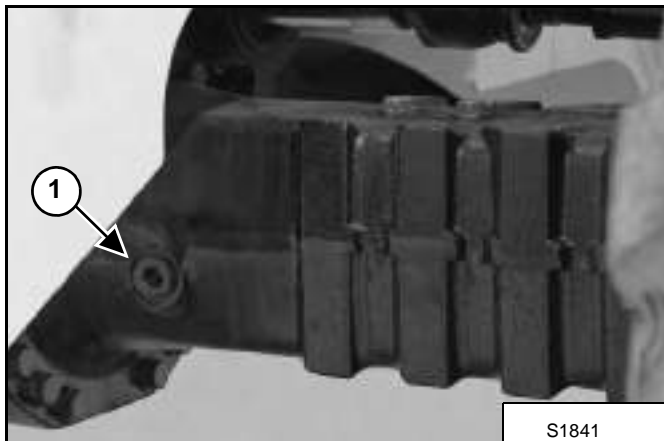

With the machine on a level surface, remove the plug (Item 1) [Figure 10-110-3]. The oil level should be at the bottom edge of the plug hole.

Add oil through the hole if the oil level is below the hole. (See "Capacities" on page SPEC-10-3 for capacity and type.)

Install and tighten the plug.

### Draining Oil (Rear Differential)

See "SERVICE SCHEDULE" on page 10-50-1 for the correct service interval.

Figure 10-110-4

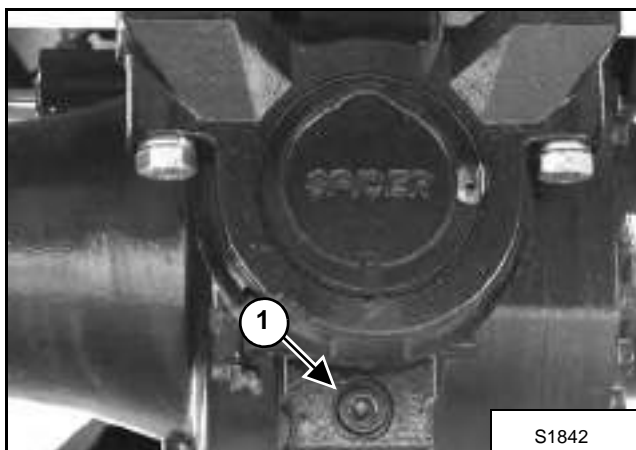

With the machine on a level surface remove the plug (Item 1) [Figure 10-110-4] and drain into a container. Recycle or dispose of the used lubricant in an environmentally safe manner. Add oil through the hole till the oil level is at the bottom edge of the plug hole.

### Checking Oil Level (Front Differential)

Figure 10-110-5

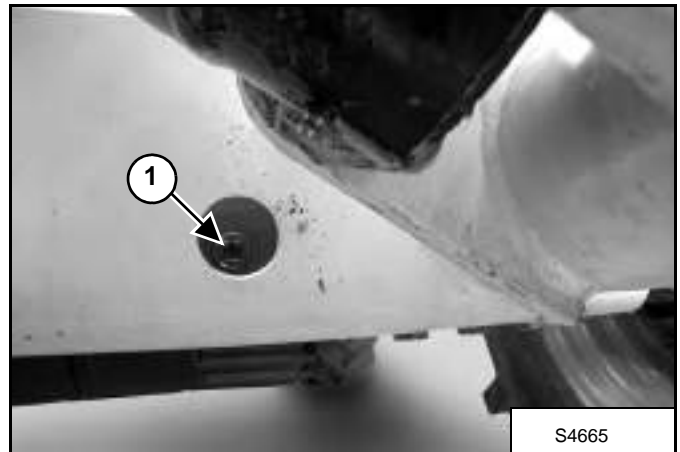
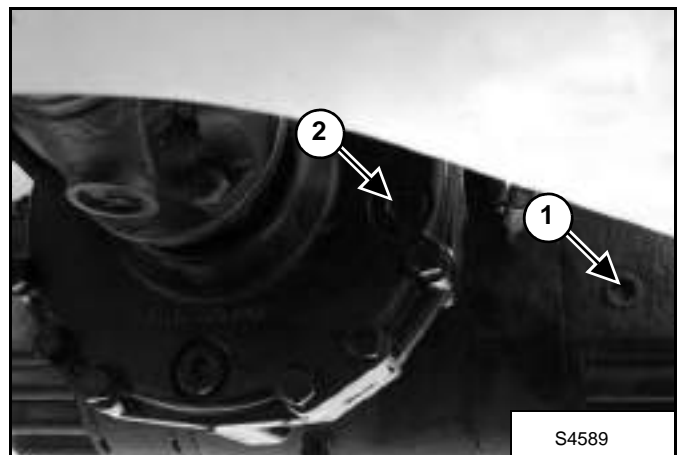

Figure 10-110-6



Remove the plugs (Item 1) [Figure 10-110-5] & (Items 1 & 2) [Figure 10-110-6]. The oil level should be at the bottom edge of the plug hole.

Add oil through the hole if the oil level is below the hole. (See "Capacities" on page SPEC-10-3 for capacity and type.)

Install and tighten the plug.

## AXLES (FRONT AND REAR) (CONT'D)

### Draining Oil (Front Differential)

See "SERVICE SCHEDULE" on page 10-50-1 for the correct service interval.

Figure 10-110-7

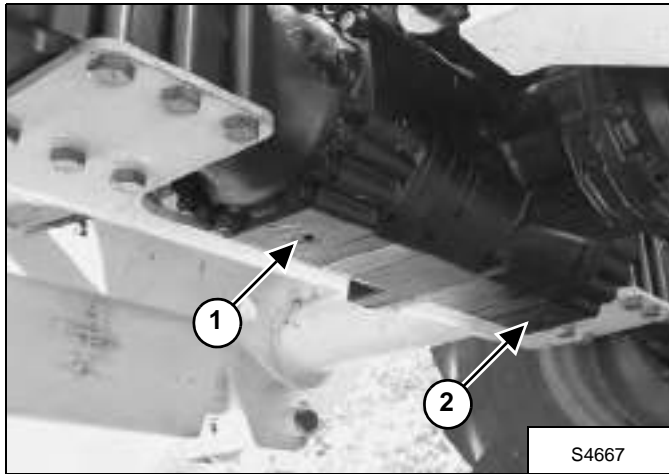

With the machine on a level surface, remove the plugs (Items 1 & 2) [Figure 10-110-7] and drain into a container. Recycle or dispose of the used lubricant in an environmentally safe manner.

Figure 10-110-8

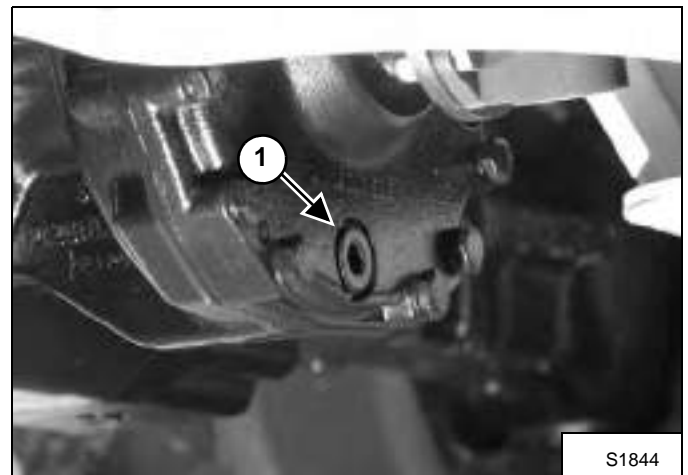
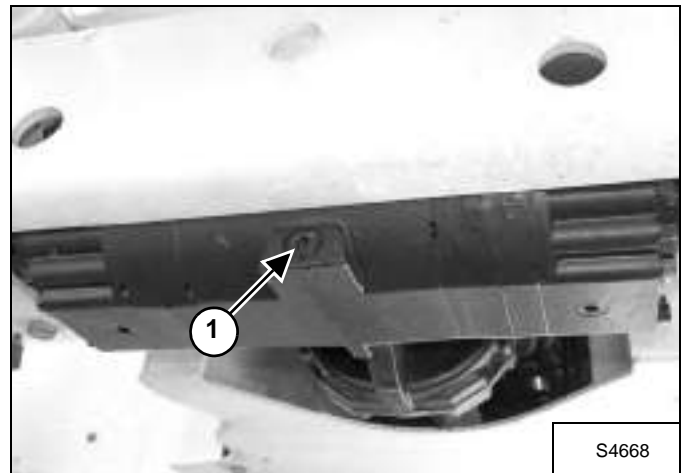

Figure 10-110-9



With the machine on a level surface, remove both plugs (Item 1) [Figure 10-110-8] & (Item 1) [Figure 10-110-9] and drain into a container. Recycle or dispose of the used lubricant in an environmentally safe manner.



**Bobcat®**

## LUBRICATION

### Procedure

Lubricate as specified (See "SERVICE SCHEDULE" on page 10-50-1) for the best performance of the machine.

Record the operating hours each time you lubricate so that it is performed at the correct interval.

Always use a good quality lithium based multi-purpose grease. Apply lubricant until extra grease shows.

Lubricate the following locations on the Telescopic Handler:

**Figure 10-120-1**

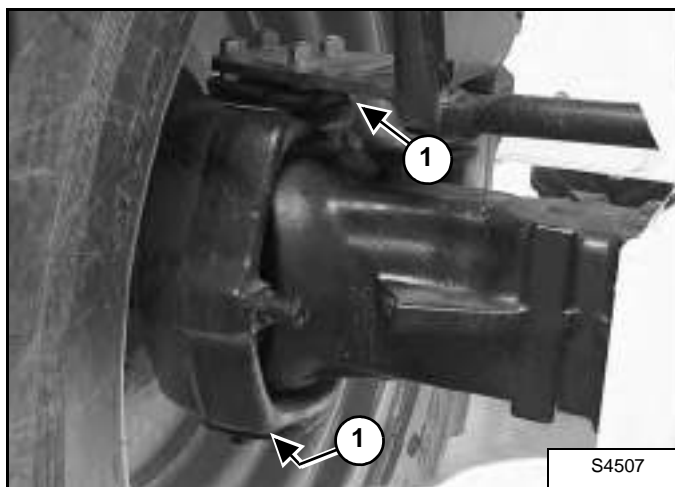

1. Axle Pivots - Top and bottom (Item 1) [Figure 10-120-1] all four wheels.

**Figure 10-120-2**

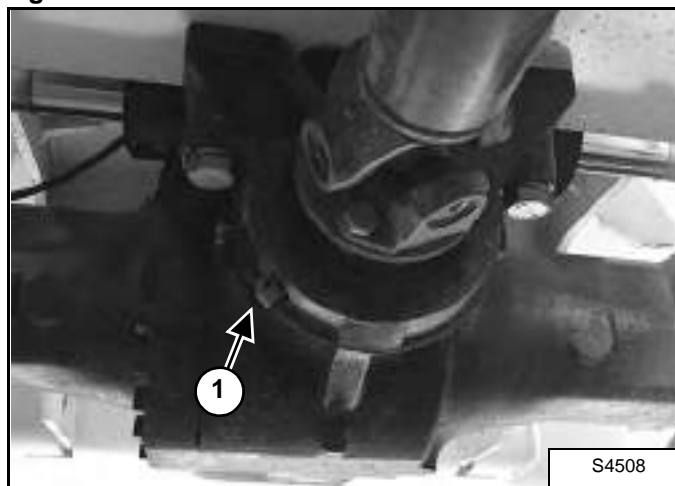

2. Axle Oscillation - Rear Axle (Item 1) [Figure 10-120-2].

**Figure 10-120-3**

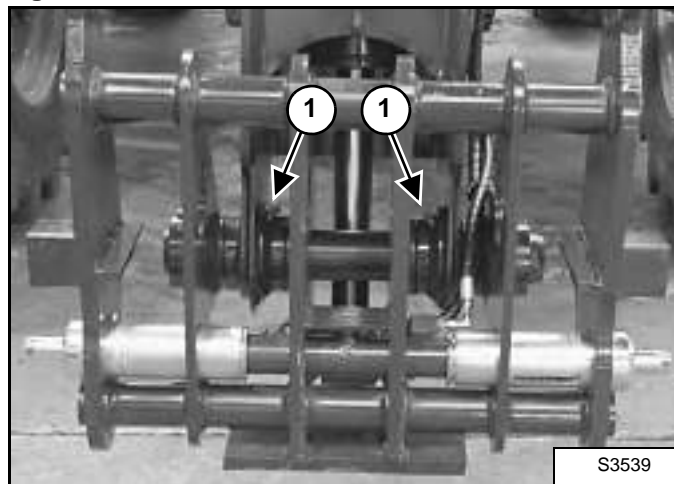

3. Attachment Frame Pivot (Item 1) [Figure 10-120-3].

**Figure 10-120-4**



4. Base end tilt cylinder (Item 1) [Figure 10-120-4].

## LUBRICATION (CONT'D)

### Procedure (Cont'd)

Figure 10-120-5

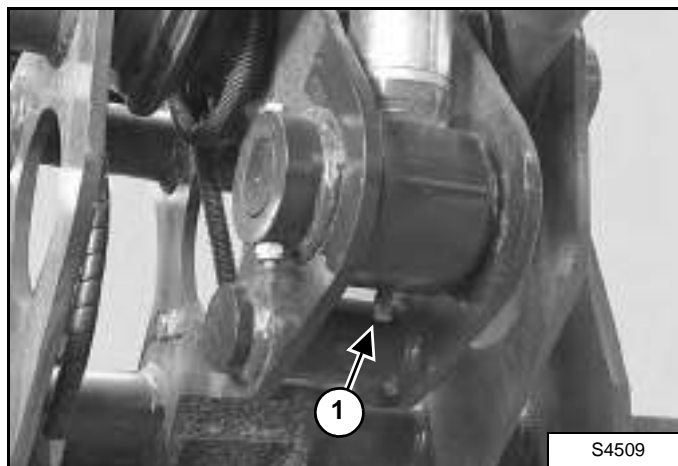

5. Rod end tilt cylinder (Item 1) [Figure 10-120-5].

Figure 10-120-6

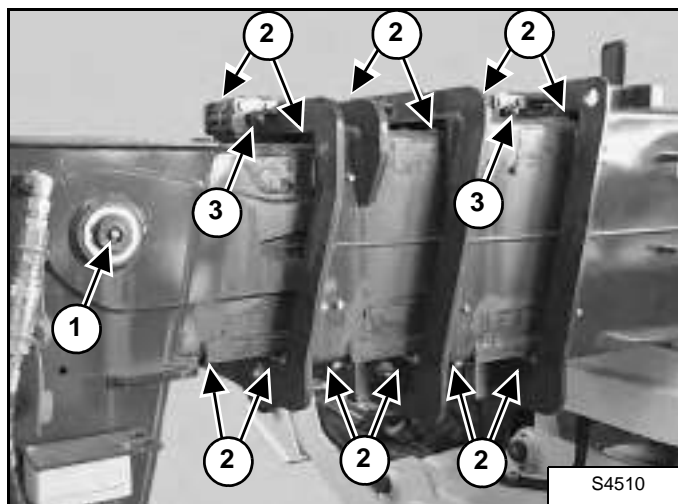

6. Tilt Cylinder pivot (on both sides) (Item 1).  
Boom Slide (Item 2) (T40170 shown, which has four boom sections versus three sections for the T40140 model).  
Chain Pulley Pivot (on both sides) (Item 3) [Figure 10-120-6] (T40170 shown, which has two front chain pulleys versus 1 for the T40140)

Figure 10-120-7

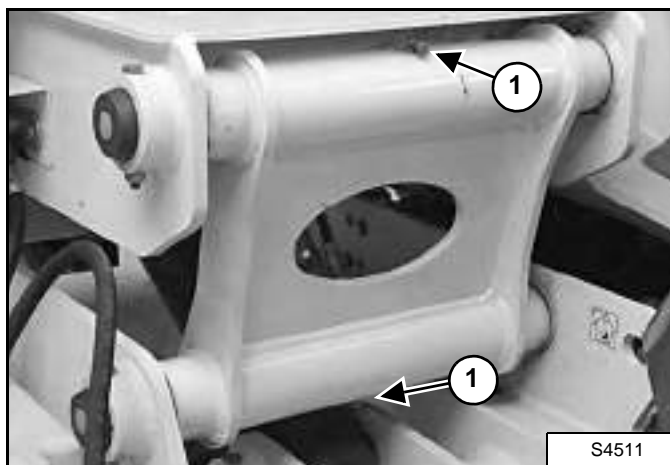

7. Cant and Side Offset Correction Frame (on both sides) (Item 1) [Figure 10-120-7].

Figure 10-120-8

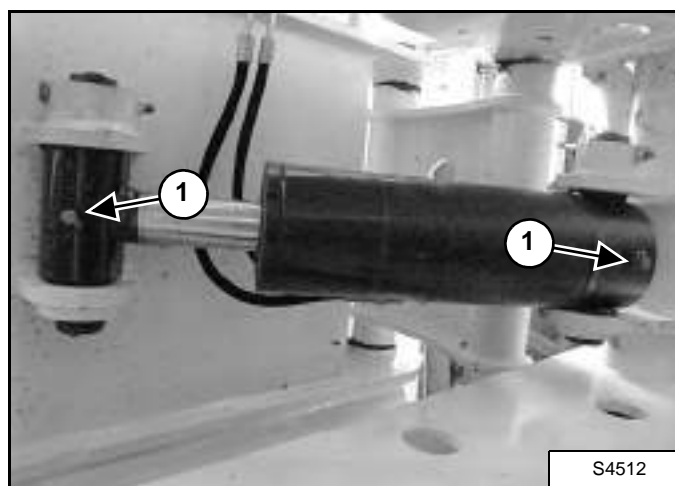

8. Cant and Side Offset Correction Cylinder (Item 1) [Figure 10-120-8] (photograph from under machine).



## LUBRICATION (CONT'D)

### Procedure (Cont'd)

Figure 10-120-9

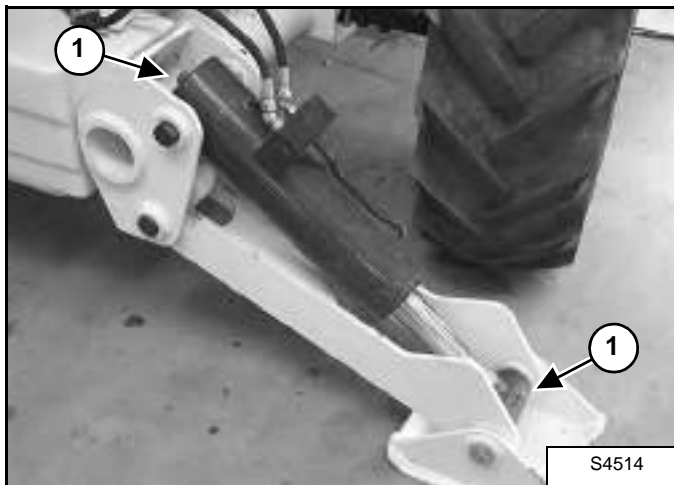

9. Stabilizer Cylinder (Item 1) [Figure 10-120-9].

Figure 10-120-10

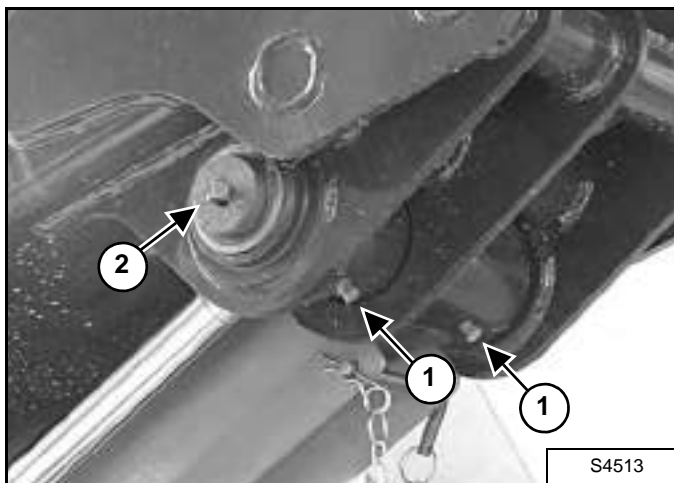

10. Lift and Slave Cylinder Rod End (Item 1) and Pivot (Item 2) [Figure 10-120-10]

**NOTE:** Raise the boom and install the boom stop (See "Installing The Approved Boom Stop" on page 10-150-1) before lubricating the boom cylinder.

Figure 10-120-11

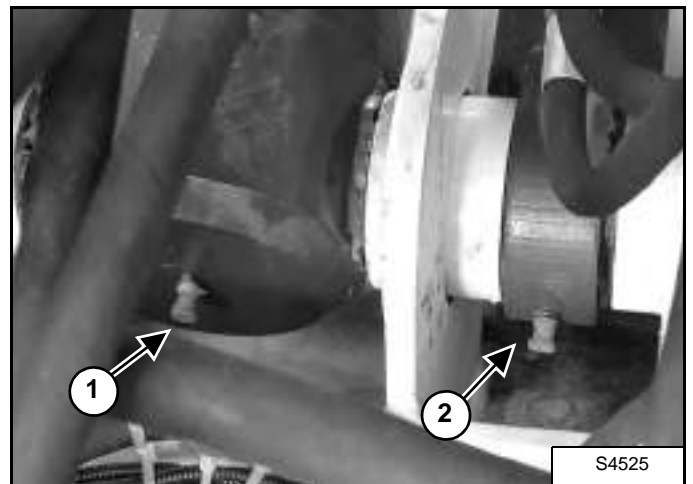

11. Lift (Item 1) and Slave (Item 2) [Figure 10-120-11] Cylinder Base End.

**NOTE:** The rear cover must be removed.

Figure 10-120-12

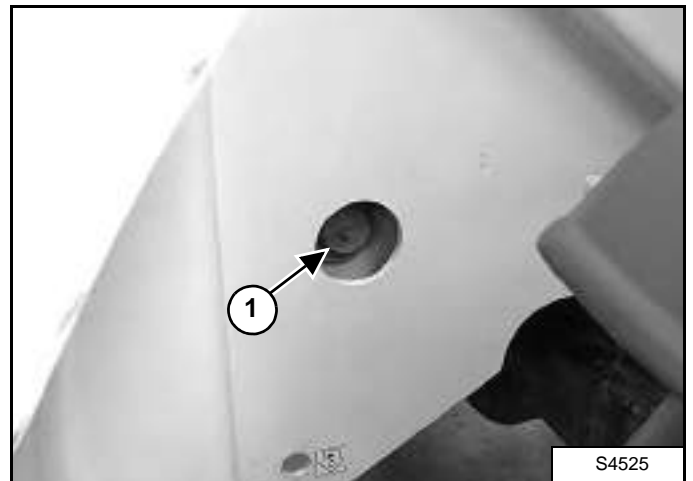

12. Lift and Slave Cylinder Pivot Pin (Item 1) [Figure 10-120-12] (both sides).

## LUBRICATION (CONT'D)

### Procedure (Cont'd)

Figure 10-120-13

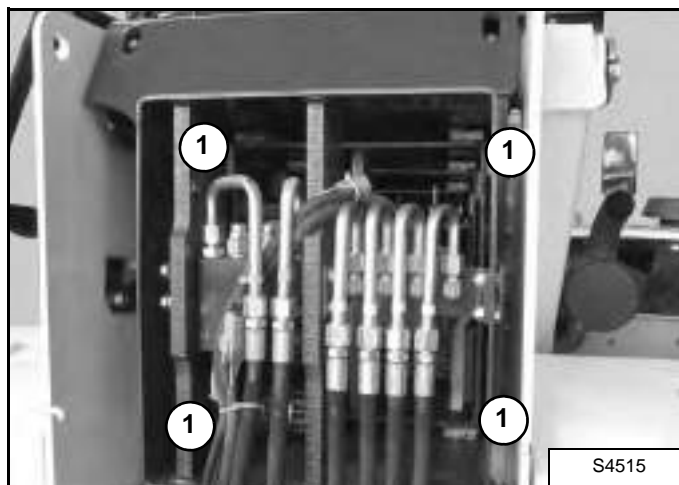

13. Boom Slide (T40170: 12 grease nipples / T40140: eight grease nipples) (Item 1) [Figure 10-120-13].

**NOTE: The rear cover must be removed.**

Figure 10-120-14

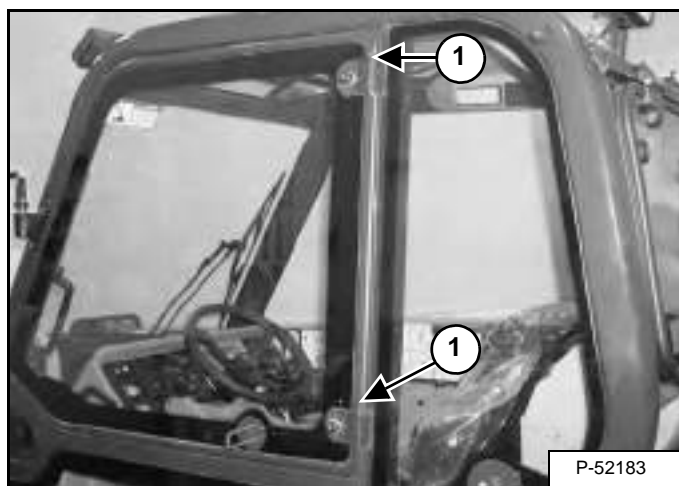

14. Cab Door Hinges (Item 1) [Figure 10-120-14] (Upper).

Figure 10-120-15

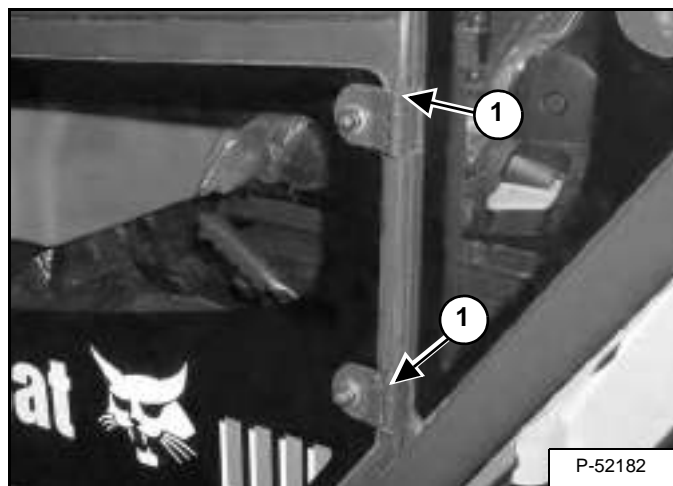

15. Cab Door Hinges (Item 1) [Figure 10-120-15] (Lower).

## TIRE MAINTENANCE

### Wheel nuts

Figure 10-130-1



See "SERVICE SCHEDULE" on page 10-50-1 for the service interval to check the wheel nuts. The correct torque is 221 ft.-lb. (300 N•m) torque **[Figure 10-130-1]**.

### Tire Rotation

Check the tires regularly for wear, damage and pressure. (See "Tires" on page SPEC-10-3 for the correct tire pressure.)

Rear tires have more wear than front tires. To keep the wear even, move the front tires to the rear and rear tires to the front.

Recommended tire pressure must be maintained to avoid excessive tire wear and loss of stability and handling capability. Check for the correct pressure before operating the loader.

## Tire Mounting

# **WARNING**

**Do not inflate tires above specified pressure. Failure to use correct tire mounting procedure can cause an explosion which can result in injury or death.**

W-2078-1285

Tires are to be repaired only by an authorized person using the correct procedures and type of equipment.

Tires and rims must always be checked for correct size before mounting. Check rim and tire bead for damage. The rim flange must be cleaned and free of rust. The tire bead and rim flange must be lubricated with a rubber lubricant before mounting the tire.

Avoid excessive pressure which can rupture the tire and cause serious injury or death.

During inflation of the tire, check the tire pressure frequently to avoid over inflation.



**Bobcat®**

## APPROVED BOOM STOP

If the boom is raised for service or maintenance, use the following procedure to install and remove the boom stop.

### Installing The Approved Boom Stop

- Put the Telescopic Handler on a flat, solid and level surface.
- With the operator in the seat, the restraint bar lowered, (if equipped) seat belt fastened, Travel Direction Control in neutral and the parking brake engaged, start the engine and raise the boom. Stop the engine.

Figure 10-150-1

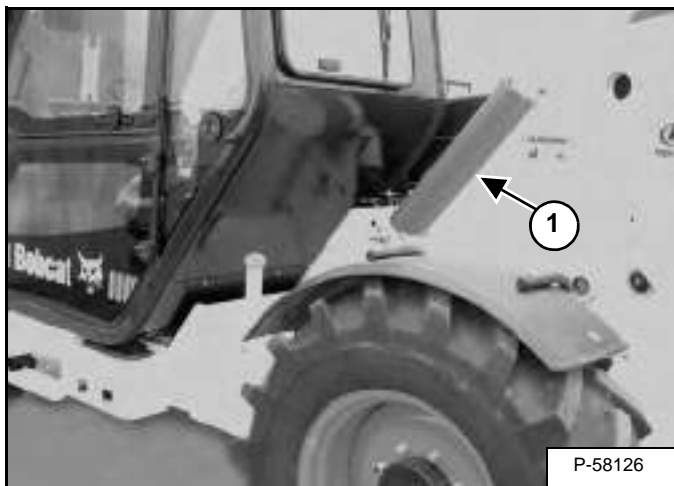

- Have a second person remove the boom stop (Item 1) [Figure 10-150-1] from the storage position.

Figure 10-150-2



- Install the boom stop over the rod of the boom cylinder [Figure 10-150-2].
- Install the pins and secure the fasteners [Figure 10-150-2].
- Start the engine and lower the boom slowly [Figure 10-150-2] so that the boom stop is held securely.

### Removing The Approved Boom Stop

- Start the engine. Lower the restraint bar (if equipped) and raise the boom. Stop the engine.
- Remove the fasteners, pins and boom stop.
- Put the boom stop in the storage position and secure with pins and fasteners.
- Start the engine lower the restraint bar (if equipped) and lower the boom



**Bobcat®**

**! WARNING**

**AVOID INJURY OR DEATH**

Never service or adjust the machine when the engine is running unless instructed to do so in the manual.

W-2012-0497

**Opening And Closing The Engine Cover**

**Figure 10-160-1**

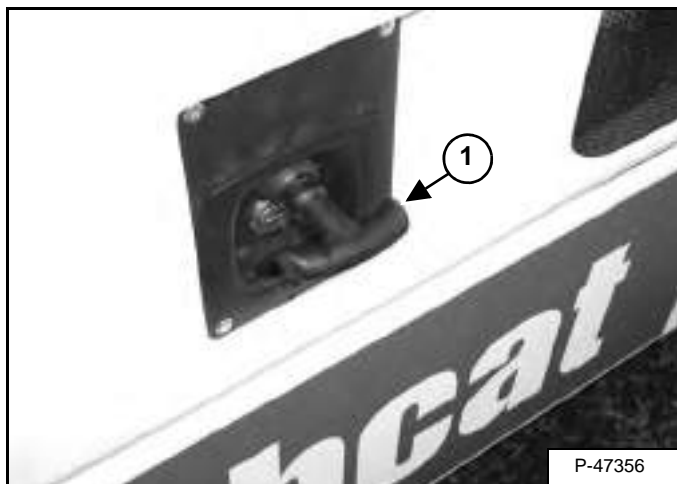

Pull up on the latch handle (Item 1) [Figure 10-160-1] and rotate counterclockwise to release latch.



**Bobcat®**



---

## HYDRAULIC SYSTEM

ACCUMULATOR . . . . .	20-210-1
Removal And Installation . . . . .	20-210-1
BRAKE VALVE . . . . .	20-120-1
Disassembly And Assembly . . . . .	20-120-2
Removal And Installation . . . . .	20-120-1
BUCKET POSITIONING CYLINDER . . . . .	20-30-1
Assembly . . . . .	20-30-3
Disassembly . . . . .	20-30-3
Parts Identification . . . . .	20-30-2
Removal And Installation . . . . .	20-30-1
DRIVE BOX . . . . .	20-70-1
Assembly . . . . .	20-70-6
Disassembly . . . . .	20-70-2
Parts Identification . . . . .	20-70-1
Special Tools . . . . .	20-70-9
EXTENSION CYLINDER . . . . .	20-40-1
Assembly . . . . .	20-40-5
Cylinder Group Removal And Installation . . . . .	20-40-1
Disassembly . . . . .	20-40-5
Parts Identification . . . . .	20-40-4
FAN MOTOR . . . . .	20-140-1
Disassembly And Assembly . . . . .	20-140-6
Parts Identification . . . . .	20-140-5
Removal And Installation . . . . .	20-140-1
FLOW CONTROL VALVE . . . . .	20-172-1
Removal And Installation . . . . .	20-172-1
FRAME LEVELING CYLINDER . . . . .	20-100-1
Assembly . . . . .	20-100-4
Disassembly . . . . .	20-100-4
Parts Identification . . . . .	20-100-3
Removal And Installation . . . . .	20-100-1
GEAR PUMP . . . . .	20-130-1
Disassembly And Assembly . . . . .	20-130-5
Parts Identification . . . . .	20-130-4
Removal And Installation . . . . .	20-130-1

**HYDRAULIC  
SYSTEM**

**Continued On Next Page**

---

## HYDRAULIC SYSTEM (CONT'D)

HYDRAULIC CONTROL VALVE . . . . .	20-170-1
Checking Drain Pressure . . . . .	20-170-1
Inlet Section Disassembly And Assembly . . . . .	20-170-17
Parts Identification . . . . .	20-170-6
Removal And Installation . . . . .	20-170-4
Section Disassembly And Assembly . . . . .	20-170-13
Section Removal . . . . .	20-170-13
Valve Section Troubleshooting (Auxiliary Section Example) . . . . .	20-170-1
HYDRAULIC RESERVOIR . . . . .	20-150-1
Removal And Installation . . . . .	20-150-1
HYDRAULIC SYSTEM INFORMATION . . . . .	20-10-1
Glossary Of Hydraulic / Hydrostatic Symbols . . . . .	20-10-1
Tightening Procedures . . . . .	20-10-5
Troubleshooting Chart . . . . .	20-10-4
LIFT CYLINDER . . . . .	20-20-1
Assembly . . . . .	20-20-6
Disassembly . . . . .	20-20-5
Parts Identification . . . . .	20-20-4
Removal And Installation . . . . .	20-20-1
MAIN RELIEF VALVE . . . . .	20-80-1
Removal and Installation . . . . .	20-80-2
Testing And Adjustment . . . . .	20-80-1
PARKING BRAKE . . . . .	20-190-1
Parking Brake Valve Disassembly And Assembly . . . . .	20-190-2
Parking Brake Valve Removal And Installation . . . . .	20-190-1
PORT RELIEF VALVES . . . . .	20-171-1
Removal And Installation . . . . .	20-171-1
PRESSURE REDUCING VALVE . . . . .	20-200-1
Removal And Installation . . . . .	20-200-2
Testing . . . . .	20-200-1
QUICK TACH CYLINDER . . . . .	20-90-1
Assembly . . . . .	20-90-4
Disassembly . . . . .	20-90-4
Parts Identification . . . . .	20-90-3
Removal And Installation . . . . .	20-90-1

Continued On Next Page

---

## HYDRAULIC SYSTEM (CONT'D)

STABILIZER CONTROL VALVE .....	20-171-1
Parts Identification .....	20-171-1
Removal .....	20-171-2
STABILIZER CYLINDER .....	20-250-1
Assembly .....	20-250-5
Disassembly .....	20-250-4
Parts Identification .....	20-250-3
Removal And Installation .....	20-250-1
STEERING CYLINDER (FRONT) .....	20-60-1
Assembling the Steering Cylinder .....	20-60-4
Disassembling the Steering Cylinder .....	20-60-3
REMOVING THE STEERING CYLINDER .....	20-60-1
STEERING CYLINDER (REAR) .....	20-61-1
Assembling the Steering Cylinder .....	20-61-6
Disassembling the Steering Cylinder .....	20-61-4
Removing the Steering Cylinder .....	20-61-1
Installing the Steering Cylinder .....	20-61-3
STEERING MODE VALVE BLOCK .....	20-110-1
Assembly .....	20-110-6
Disassembly .....	20-110-4
Parts Identification .....	20-110-3
Removal And Installation .....	20-110-1
Solenoid Testing .....	20-110-6
STEERING VALVE .....	20-160-1
Disassembly .....	20-160-3
Parts Identification .....	20-160-2
Removal And Installation .....	20-160-1
TILT CYLINDER .....	20-50-1
Assembly .....	20-50-4
Disassembly .....	20-50-4
Parts Identification .....	20-50-3
Removal And Installation .....	20-50-1
TOW VALVE .....	20-220-1
Disassembly And Assembly .....	20-220-2
Removal And Installation .....	20-220-1

















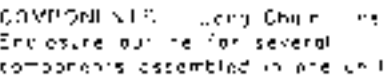

**Bobcat®**

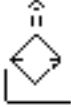
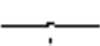
## HYDRAULIC SYSTEM INFORMATION

### Glossary Of Hydraulic / Hydrostatic Symbols

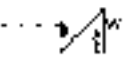
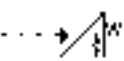











#### GLOSSARY OF HYDRAULIC/HYDROSTATIC SYMBOLS

SYMBOL	DESCRIPTION	SYMBOL	DESCRIPTION
<b>FLOW LINES and CONNECTIONS</b>		<b>BASIC and MISCELLANEOUS SYMBOLS</b>	
	<b>WORKING LINES</b> - Continuous Solid Line - Working (Main) Line, Return Line (line conducting fluid from working devices to the reservoir) and Feed Line (main line conductor)		<b>RESTRICTION</b> - Line with Fixed Restriction - Affected by viscosity (property of resistance to flowing fluid)
	<b>PILOT PRESSURE</b> - Dashed Line Pilot Line (line which conducts control fluid)		<b>VARIABLE RESTRICTION</b> - Regulated or Variable Restriction
	<b>DRAIN CIRCUITS</b> - Dotted Line Drain Line (drain or bleed line - line conducting fluid from a component leading to the reservoir)		<b>TEMPERATURE CONTROL</b> - Line control of temperature
	<b>COMPONENTS</b> - Long Chain Line Enclosure outline for several components assembled in one unit		<b>TEMPERATURE INDICATOR</b> - Temperature measurement (thermometer)
	<b>MECHANICAL CONNECTIONS</b> - Double line (Shaft, Lever, Piston Rod)		<b>FILTER</b> (strainer or screen) - For fluid conditioning
	<b>CONNECTED JUNCTION OF LINES</b> (if flow line connected)		<b>VENTED AND FILTERED RESERVOIR</b> (reservoir open to atmosphere)
	<b>LINE CROSSING</b> (NOT Connected)		<b>OIL COOLER</b> (heat exchanger) - The arrows in the diamond indicate the direction of heat transfer (dissipation)
	<b>COUPLING</b> - Quick-acting Coupling (uncoupled - closed by non-return valve)		<b>PRESSURE SENSOR</b> - Valve which is signal with pressure
			<b>DIFFERENTIAL PRESSURE SWITCH</b> - Switch activates when pressure difference reaches specified level
			<b>PRESSURE SWITCH</b> - Switch activates when pressure reaches specified level
			<b>MUFFLER</b> (silencer) - Reduces noise

mc-2340

## HYDRAULIC SYSTEM INFORMATION (CONT'D)

### Glossary Of Hydraulic / Hydrostatic Symbols (Cont'd)

GLOSSARY OF HYDRAULIC/HYDROSTATIC SYMBOLS			
SYMBOL	DESCRIPTION	SYMBOL	DESCRIPTION
	<b>CYLINDER</b> - Equipment to convert hydraulic energy into linear energy and in which the fluid pressure operates alternately in both directions (forward and backward strokes):		<b>CONTROL MECHANISMS</b>
	<b>SINGLE ACTING HYDRAULIC CYLINDER (UNEQUAL DISPLACEMENT)</b> - With single direction		<b>CONTROL VALVE WITH DETENT</b> (holds Valve in Position) - device for maintaining a given position (mechanical)
	<b>DOUBLE ACTING HYDRAULIC CYLINDER (EQUAL DISPLACEMENT)</b> and cushion on ONE END - With single direction		<b>CONTROL VALVE ACTIVATED BY A PUSH BUTTON</b> (mechanical)
	<b>PUMP</b> - To convert mechanical energy into hydraulic energy		<b>CONTROL VALVE ACTIVATED BY A PUSH/PULL BUTTON</b> (mechanical)
	<b>FIXED CAPACITY DISPLACEMENT HYDRAULIC PUMP</b> - With one direction of flow		<b>CONTROL VALVE ACTIVATED BY A LEVER</b> (mechanical)
	<b>VARIABLE CAPACITY DISPLACEMENT DIRECTIONAL HYDRAULIC PUMP</b> - With two directions of flow (bidirectional)		<b>CONTROL VALVE ACTIVATED BY A PEDAL</b> (mechanical)
	<b>MOTOR</b> - To convert hydraulic energy into rotary mechanical energy		<b>CONTROL VALVE WITH SPRING RETURN</b> (mechanical)
	<b>FIXED CAPACITY DISPLACEMENT BIDIRECTIONAL HYDRAULIC MOTOR</b> - With two directions of flow (bidirectional)		<b>CONTROL VALVE ACTIVATED BY AN ELECTRIC SOLENOID</b> (electrical)
			<b>CONTROL VALVE ACTIVATED BY PILOT PRESSURE</b> (pressure control pilot actuated by operator or air pressure)

mc-2340-2

## HYDRAULIC SYSTEM INFORMATION (CONT'D)

### Glossary Of Hydraulic / Hydrostatic Symbols (Cont'd)

#### GLOSSARY OF HYDRAULIC/HYDROSTATIC SYMBOLS

SYMBOL DESCRIPTION

**NON RETURN VALVE, SHUTTLE VALVE** Valve which allows free flow in one direction only

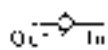

**NON RETURN VALVE (Check Valve)** - Used as Replenishing Valve, Load Check Valve or Anti-cavitation Valve - Opens if the Inlet pressure is higher than the Outlet pressure. Other contains return spring which has NO significant pressure value

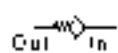

**SPRING LOADED VALVE (Check Valve)** - Opens if the Inlet pressure is greater than the Outlet pressure plus the spring pressure

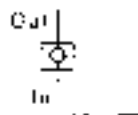

**PILOT CONTROLLED NON-RETURN VALVE** - It is possible to open the valve by pilot pressure

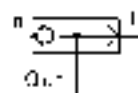

**SHUTTLE VALVE** - The Inlet port connected to the higher pressure is automatically connected to the Outlet port while the other inlet port is closed

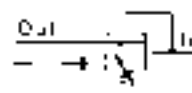

**DUAL PRESSURE RELIEF VALVE** - When the Inlet pressure overcomes the opposing force of the spring, the valve opens permitting flow from the Outlet port. Pilot pressure provides a second pressure value

**DIRECTIONAL CONTROL VALVE** Valve providing for the opening (fully or restricted) or the closing of one or more flow paths (represented by several squares)



**TWO PORTS and CLOSED FLOW PATH**

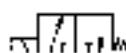

**SOLENOID ACTUATED DIRECTIONAL CONTROL VALVE (Two Position) - controlled by an electric current (with return spring)**

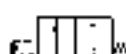

**PILOT ACTUATED DIRECTIONAL CONTROL VALVE (Two Position) - controlled by pressure (with return spring)**

SYMBOL DESCRIPTION

**PRESSURE CONTROL VALVE** Valve ensuring the control of pressure

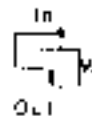

**RELIEF VALVE** - When the Inlet pressure overcomes the opposing force of the spring, the valve opens permitting flow from the Outlet port.

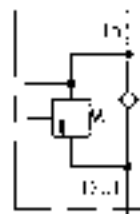

**RELIEF/REPLENISHING VALVE or RELIEF/ANTI-CAVITATION VALVE** - When the Inlet pressure overcomes the opposing force of the spring, the valve opens permitting flow from the Outlet port - Allows free flow in the opposite direction

**FLOW CONTROL VALVE** Valve controlling the flow in one or both directions

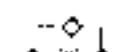

**ONE WAY RESTRICTOR VALVE (Non Return valve with Restriction)** - Let it allowing free flow in one direction but restricted flow in the other direction



**TWO WAY VALVE** - Normally in closed position

mc-2340-3

## HYDRAULIC SYSTEM INFORMATION (CONT'D)

### Troubleshooting Chart

The following troubleshooting chart is provided for assistance in locating and correcting problems which are most common. Many of the recommended procedures must be done by authorized Bobcat Service Personnel only.



## WARNING

**Check for correct function after adjustments, repairs or service. Failure to make correct repairs or adjustments can cause injury or death.**

W-2004-1285

PROBLEM	CAUSE
The hydraulic system will not operate.	1, 2, 3, 6
The hydraulic oil temperature warning light comes ON when hydraulics are operating.	1, 2
Slow hydraulic system action.	1, 2, 4, 8
Hydraulic action is not smooth.	1, 3, 4, 5
Boom goes up slowly at full engine RPM.	1, 2, 4, 5, 6, 7
The boom comes down with the lever in neutral position.	7, 8, 9

### KEY TO CORRECT THE CAUSE

1. The fluid level is not correct.
2. The hydraulic pump has damage.
3. Relief valve is not at the correct pressure.
4. Suction leak on the inlet side of the hydraulic pump.
5. Fluid is cold. Wrong viscosity fluid.
6. Using the machine for more than its rated capacity.
7. Internal leak in the lift cylinder.
8. External leak from the cylinder(s).
9. Damaged lift spool.



---

## HYDRAULIC SYSTEM INFORMATION (CONT'D)

### Tightening Procedures

# IMPORTANT

When repairing hydrostatic and hydraulic systems, clean the work area before disassembly and keep all parts clean. Always use caps and plugs on hoses, tubelines and ports to keep dirt out. Dirt can quickly damage the system.

I-2003-0888

---

To tighten the hydraulic fittings, tubelines etc. See "HYDRAULIC CONNECTION SPECIFICATIONS" on page SPEC-50-1, for the correct procedure and torque.

# IMPORTANT

When replacing the four ring pistons with three ring pistons, a complete set of four pistons must be used. **DO NOT** use the three and four ring pistons in the same engine.

I-2145-1297

---



**Bobcat®**

## LIFT CYLINDER

### Removal And Installation

Figure 20-20-1



Lower the boom onto adequate stands or blocks as shown in [Figure 20-20-1].

Figure 20-20-2



Remove the rear cover (Item 1) [Figure 20-20-2] from the machine.

Figure 20-20-3

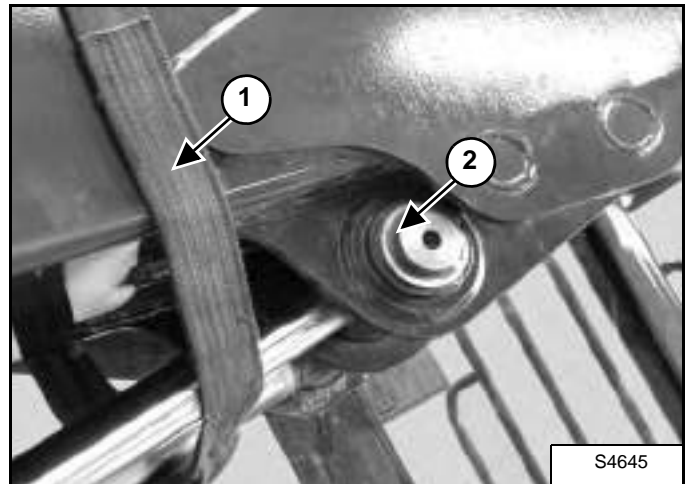

Use a strap and a hoist (Item 1) [Figure 20-20-3] to support the lift cylinder and bucket positioning cylinder.

Remove the pivot pin snap ring (Item 2) [Figure 20-20-3] from the rod end.

Figure 20-20-4

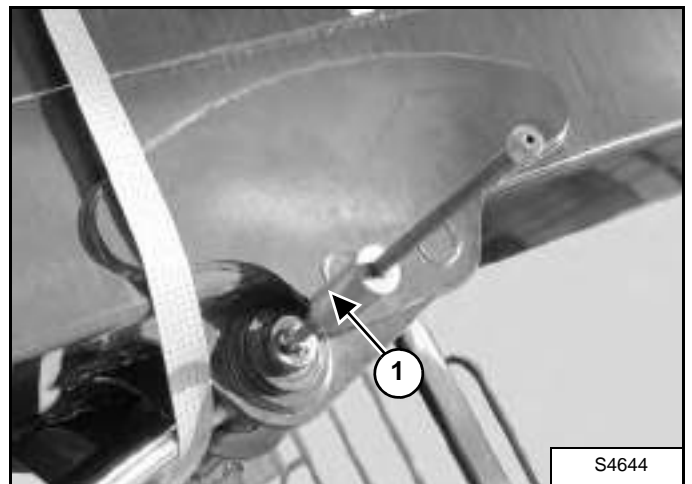

Remove the upper pivot pin using a pin removal tool (Item 1) [Figure 20-20-4].

**NOTE: If a nut must be welded onto the pin for removal the following three steps must be performed:**

1. Rotate the battery disconnect switch to the right to disconnect the power supply from the battery.
2. The side window and frame opening must be protected from sparks.
3. The cylinder rod must be wrapped with a damp welding blanket to prevent damage.

## LIFT CYLINDER (CONT'D)

### Removal And Installation (Cont'd)

Figure 20-20-5



After the upper pivot pin has been removed, the rod end of the cylinders should be lowered onto a wood block, positioned as shown [Figure 20-20-5].

Figure 20-20-6

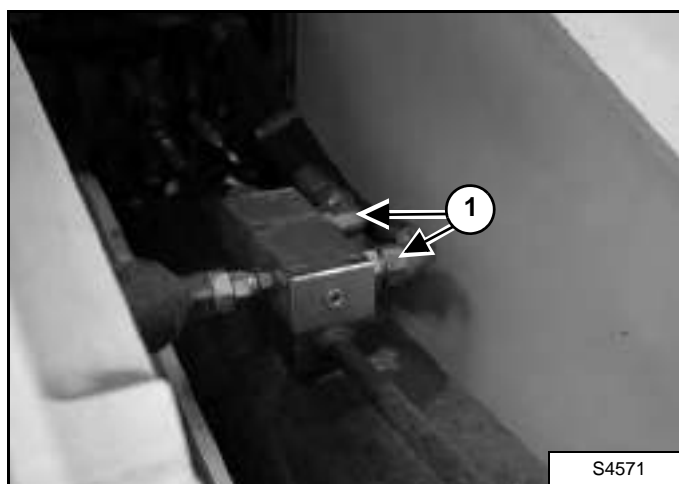

Remove the two hoses (Item 1) [Figure 20-20-6] from the lift lock on the lift cylinder.

Figure 20-20-7

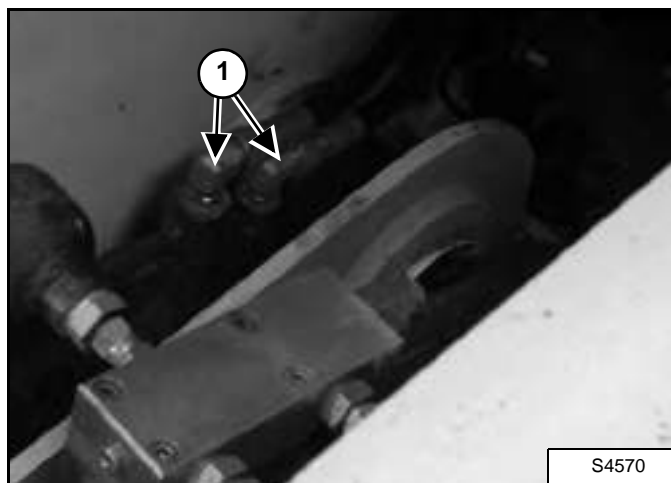

Remove the two hoses (Item 1) [Figure 20-20-7] from the lift lock on the bucket positioning cylinder.

**NOTE:** Mark all hoses for correct installation.

## IMPORTANT

When repairing hydrostatic and hydraulic systems, clean the work area before disassembly and keep all parts clean. Always use caps and plugs on hoses, tubelines and ports to keep dirt out. Dirt can quickly damage the system.

I-2003-0888

Figure 20-20-8

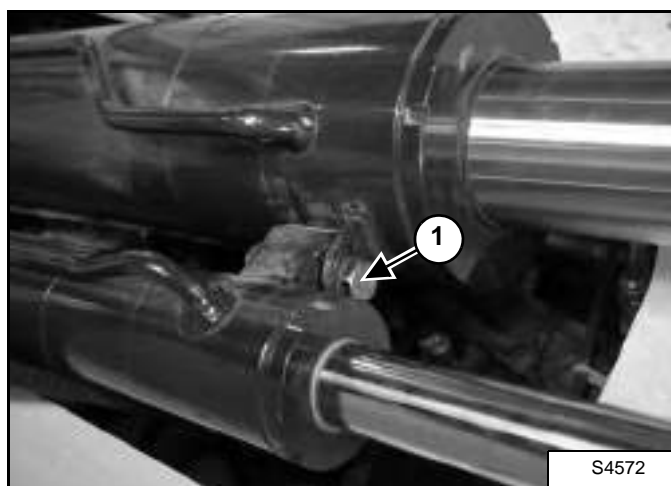

Remove the bolt (Item 1) [Figure 20-20-8] from the lift cylinder and bucket positioning cylinder.

## LIFT CYLINDER (CONT'D)

### Removal And Installation (Cont'd)

Figure 20-20-9

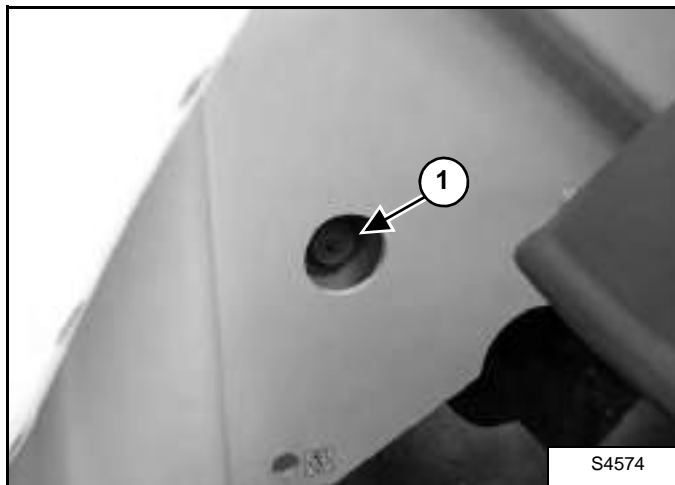

Remove the base end pivot pin snap ring (Item 1) [Figure 20-20-9].

Figure 20-20-10

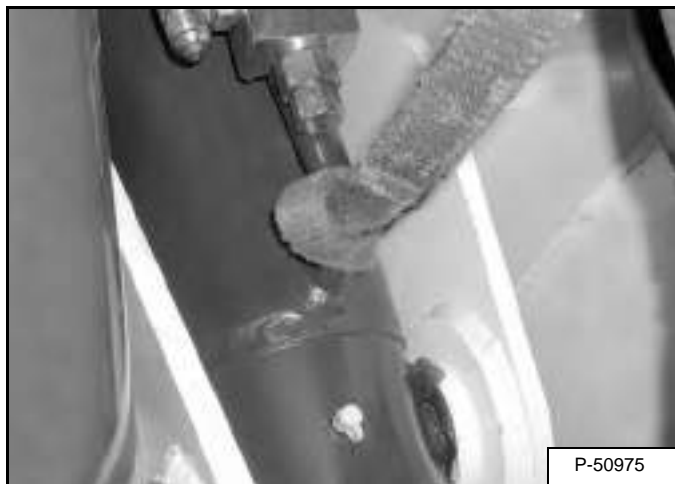

Lift and support the base end of the cylinders as shown in [Figure 20-20-10].

Figure 20-20-11



Remove the base end pivot pin (Item 1) [Figure 20-20-11].

Lift and remove the lift cylinder from the machine.

## LIFT CYLINDER (CONT'D)

### Parts Identification

1. Cylinder body
2. Inner ring
3. Bush
4. Grease nipple
5. Cap grease nipple
6. Cylinder head
7. Piston
8. Screw
9. Rod
10. Set of seals

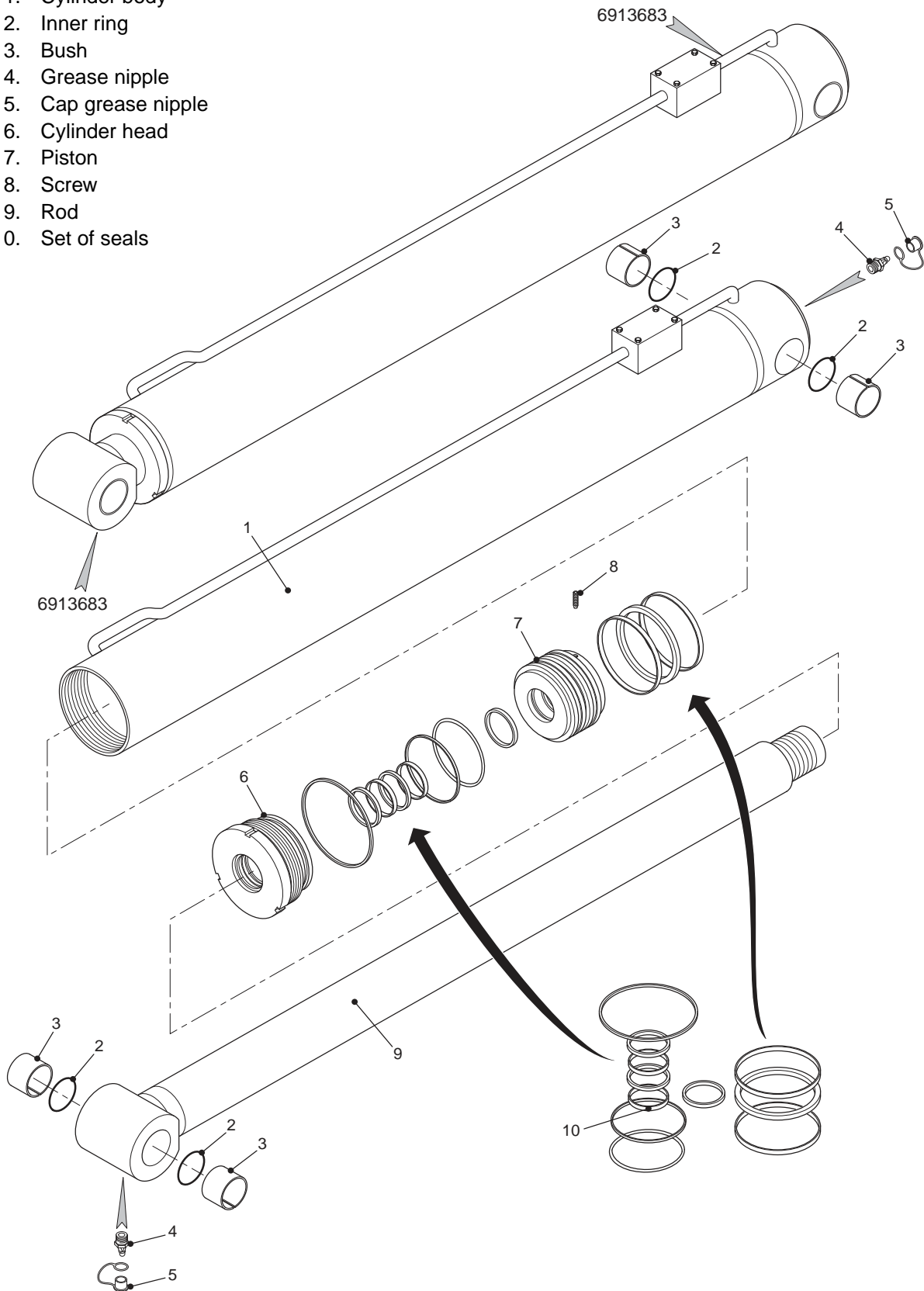

S4703

## LIFT CYLINDER (CONT'D)

### Disassembly

Figure 20-20-12



Use the following tools to disassemble the cylinders:

MEL1354-Spanner Wrench

MEL1076-Cylinder Wrench

Put the cylinder in a vise [Figure 20-20-12].

Figure 20-20-13

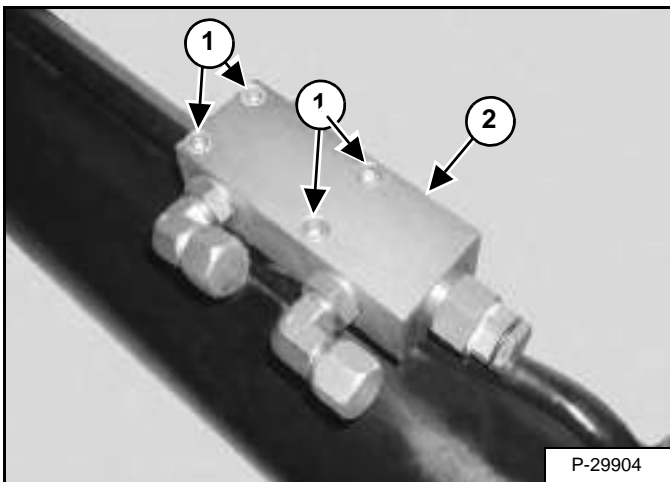

Remove the four bolts (Item 1) and remove the lift lock (Item 2) [Figure 20-20-13].

Figure 20-20-14

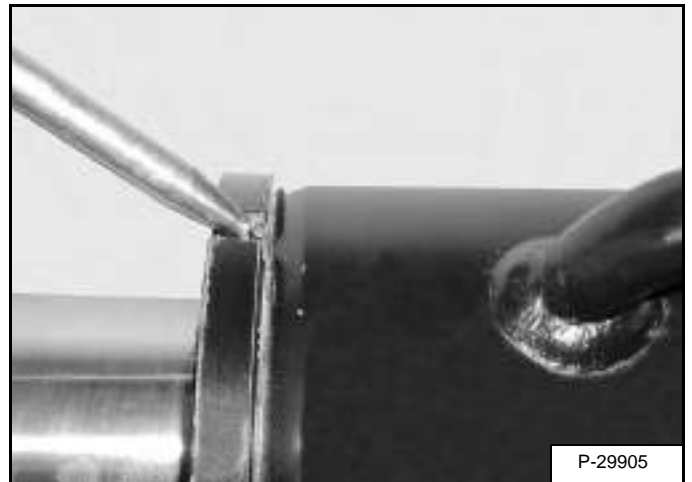

Carefully peen the lock ring from the head gland [Figure 20-20-14].

Figure 20-20-15

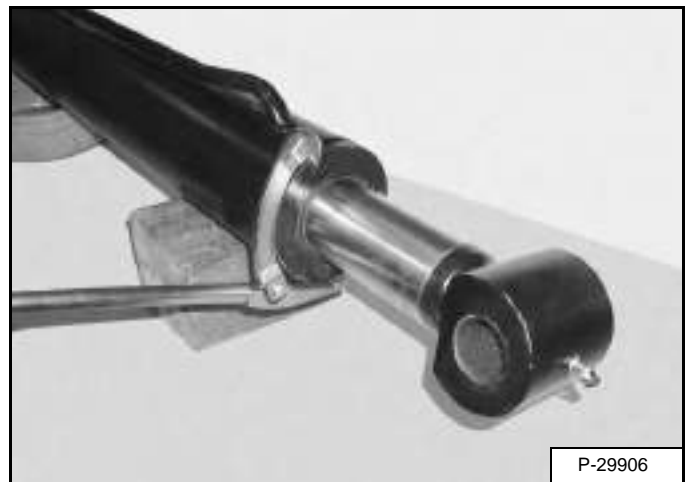

Use a spanner wrench to loosen the head gland [Figure 20-20-15].

---

## LIFT CYLINDER (CONT'D)

### Assembly

Use the following tools to assemble the cylinders:

MEL1354-Spanner Wrench

MEL1076-Cylinder Wrench

MEL1033-Rod Seal Installation Tool

Wash the cylinder parts in solvent and dry with compressed air.

Inspect the cylinder parts for nicks, scratches or other damage. Replace any damaged parts.

Lubricate all O-rings and seals with hydraulic oil during installation. Always use new O-rings and seals.

Clean off any old residue, and apply LOCTITE 242 or equivalent to the threads on the rod (Item 9) (See "Parts Identification" on page 20-20-4).



---

## **BUCKET POSITIONING CYLINDER**

### **Removal And Installation**

Perform all steps for the removal of the lift cylinder (See Removal And Installation on Page 20-20-1).

Instead of removing the lift cylinder, remove the bucket positioning cylinder from the machine.

# BUCKET POSITIONING CYLINDER (CONT'D)

## Parts Identification

1. Cylinder assy
2. Cylinder
3. Bush
4. Grease nipple
5. Rod
6. Cylinder head
7. Piston
8. Screw
9. Seals kit

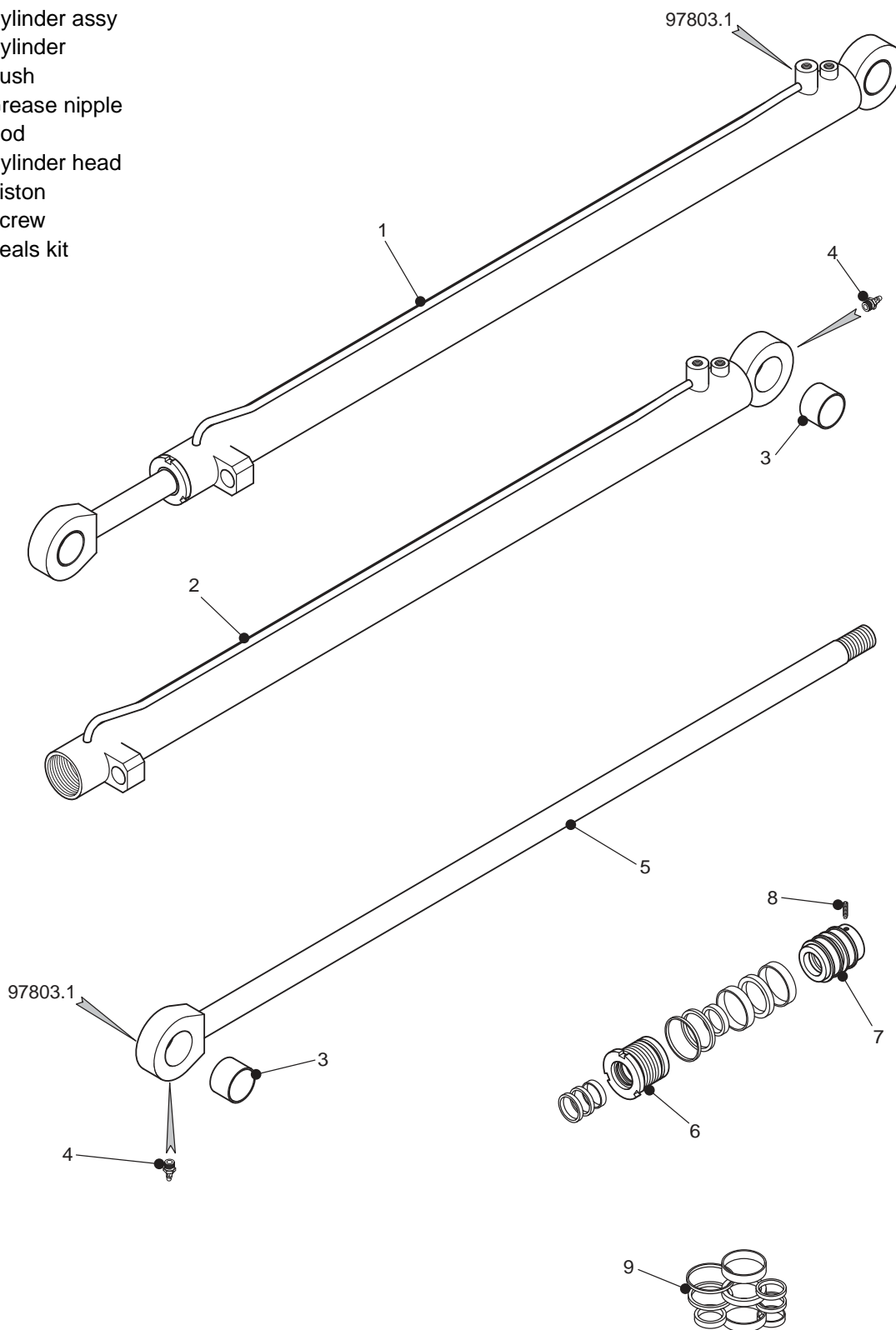

S4704

## BUCKET POSITIONING CYLINDER (CONT'D)

### Disassembly

Use the following tools to disassemble the cylinder:

MEL1354-Spanner Wrench

**Figure 20-30-1**

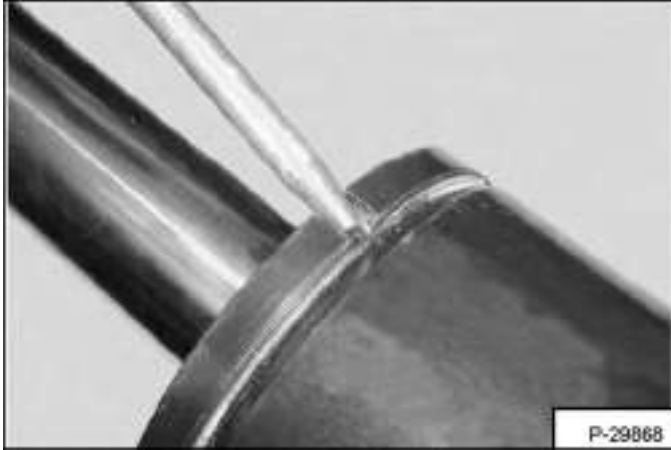

Carefully peel the lock ring from the head gland  
[Figure 20-30-1].

**Figure 20-30-2**



Use a spanner wrench to remove the head gland  
[Figure 20-30-2].

### Assembly

Use the following tools to assemble the cylinder:

MEL1354-Spanner Wrench

MEL1033-Rod Seal Installation Tool.

Wash the cylinder parts in solvent and dry with compressed air.

Inspect the cylinder parts for nicks, scratches or other damage. Replace any damaged parts.

Lubricate all O-rings and seals with hydraulic oil during installation.

Always use new O-rings and seals.

Apply LOCTITE 242 or equivalent to the threads on the rod (Item 5) (See "Parts Identification" on page 20-30-2).

Apply LOCTITE 242 or equivalent to the set screw (Item 8) (See "Parts Identification" on page 20-30-2).



**Bobcat®**

## EXTENSION CYLINDER

### Cylinder Group Removal And Installation

Figure 20-40-1



Start the engine and raise the boom until the boom is in the horizontal position [Figure 20-40-1]. Make sure that the booms are retracted.

Figure 20-40-2



Remove the rear cover (Item 1) [Figure 20-40-2] from the machine.

Figure 20-40-3

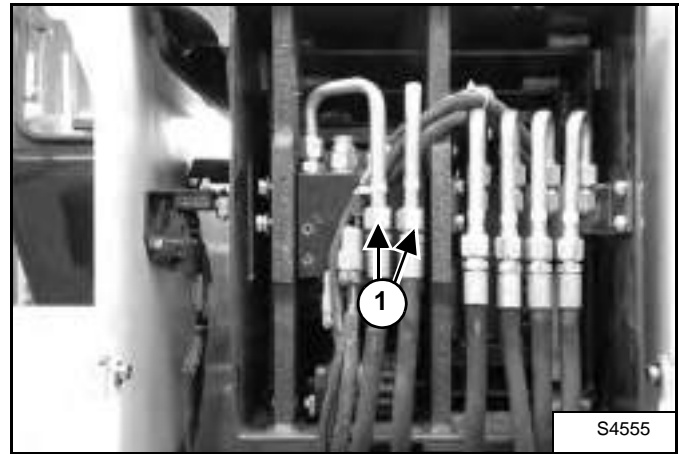

Disconnect the two tubelines (Item 1) [Figure 20-40-3] from the fittings.

**NOTE:** Mark all hoses for correct installation.

## IMPORTANT

When repairing hydrostatic and hydraulic systems, clean the work area before disassembly and keep all parts clean. Always use caps and plugs on hoses, tubelines and ports to keep dirt out. Dirt can quickly damage the system.

I-2003-0888

Figure 20-40-4

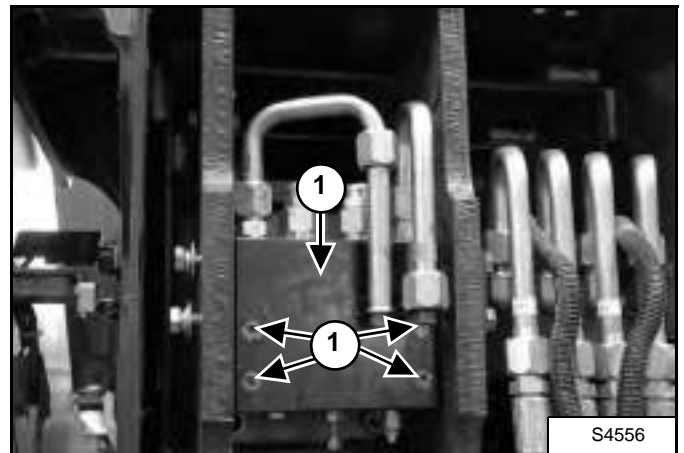

Remove the valve block (Item 1) from the extension cylinder by removing the four screws (Item 2) [Figure 20-40-4].

## EXTENSION CYLINDER (CONT'D)

### Cylinder Group Removal And Installation (Cont'd)

Figure 20-40-5

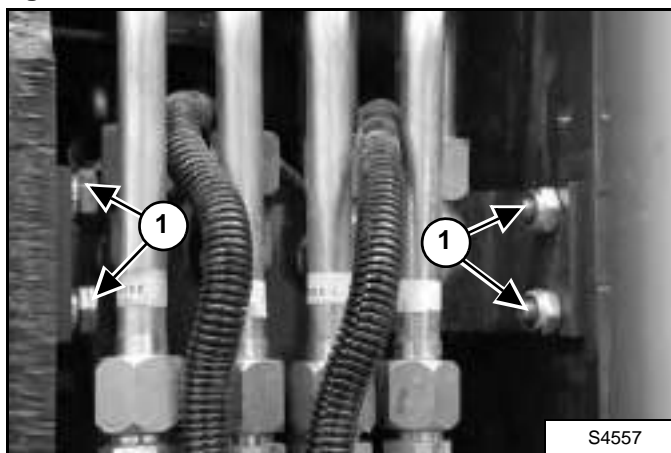

Remove the four bolts and nuts (Item 1) [Figure 20-40-5] and pull the tubelines back.

Figure 20-40-6

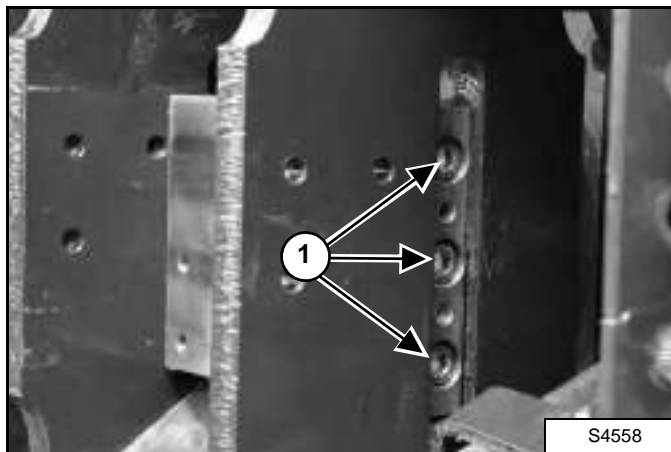

Remove the attachment screws (Item 1) [Figure 20-40-6] from both sides of the cylinder head.

Figure 20-40-7



Remove the support blocks. [Figure 20-40-7].

Remove the four attachment screws from the cylinder body.

Figure 20-40-8



Lift and remove the cylinder out of the boom [Figure 20-40-8].

---

## EXTENSION CYLINDER (CONT'D)

### Cylinder Group Removal And Installation (Cont'd)

Figure 20-40-9

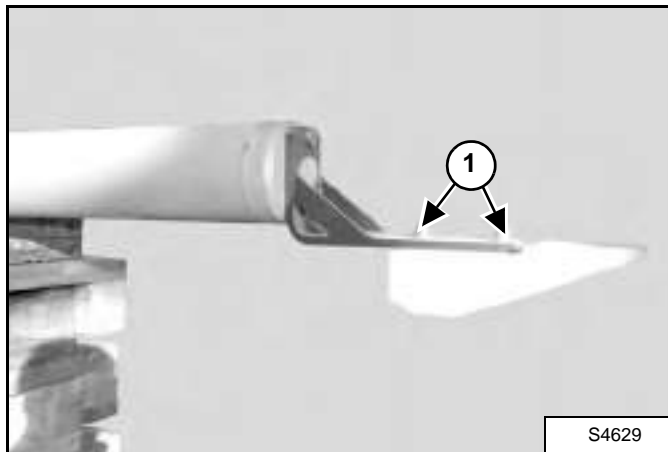

Remove the skid that enables the telescoping cylinder shaft to be held on the caisson by removing the two bolts (Item1) [Figure 20-40-9].

## EXTENSION CYLINDER (CONT'D)

### Parts Identification

1. Cylinder
2. Cylinder
3. Plug
4. Rod
5. Cylinder head
6. Stop
7. Ring
8. Piston
9. Screw
10. Plug
11. Seal kit

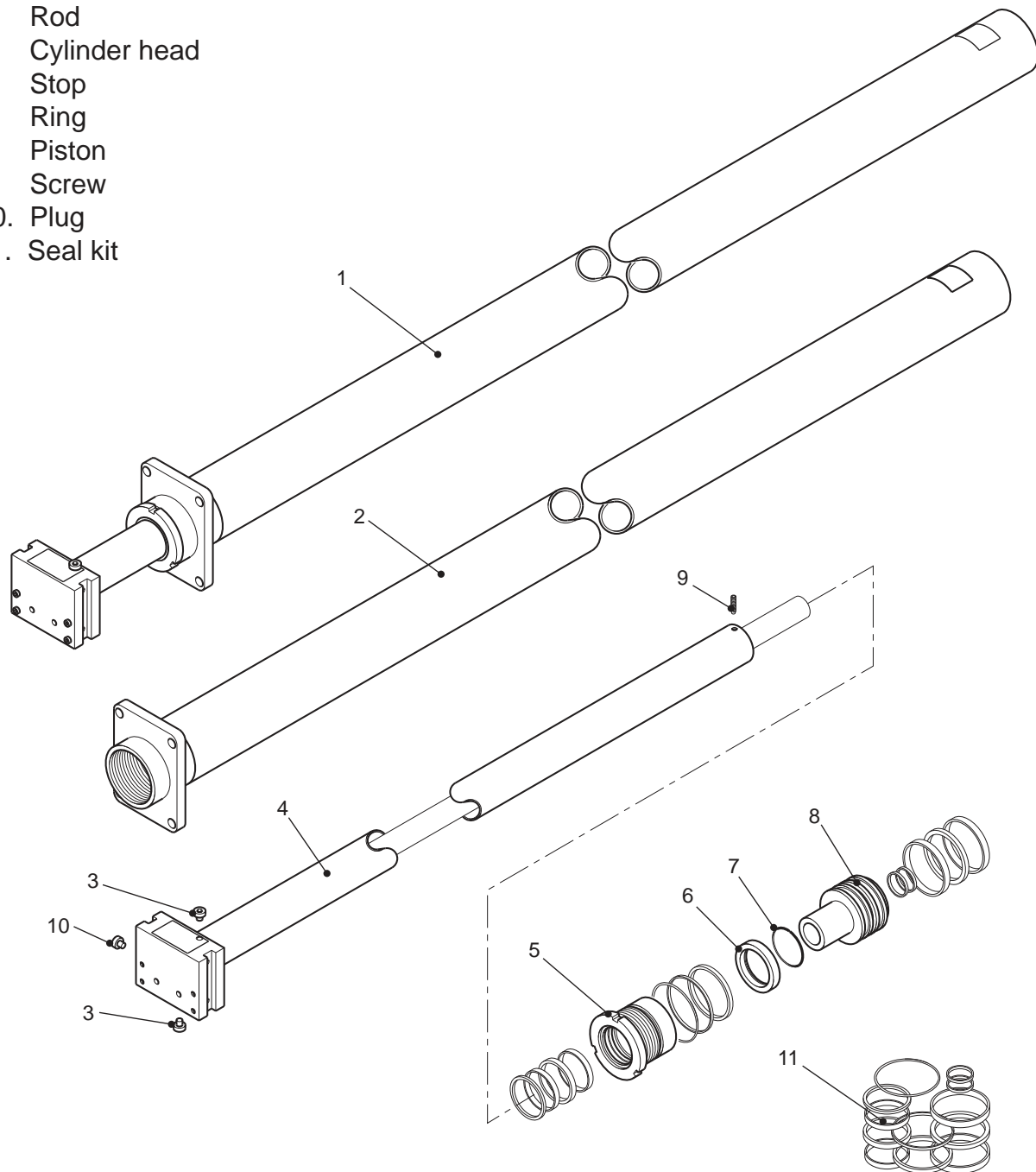

B-19853



## EXTENSION CYLINDER (CONT'D)

### Disassembly

Use the following tools to disassemble the cylinder:

Spanner Wrench

Cylinder Wrench

**Figure 20-40-10**

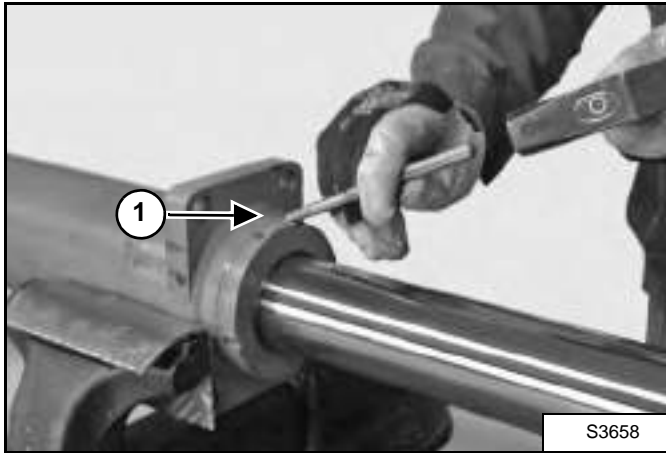

Carefully peen the lock ring (Item 1) [Figure 20-40-10] up and out of the lock groove.

**Figure 20-40-11**

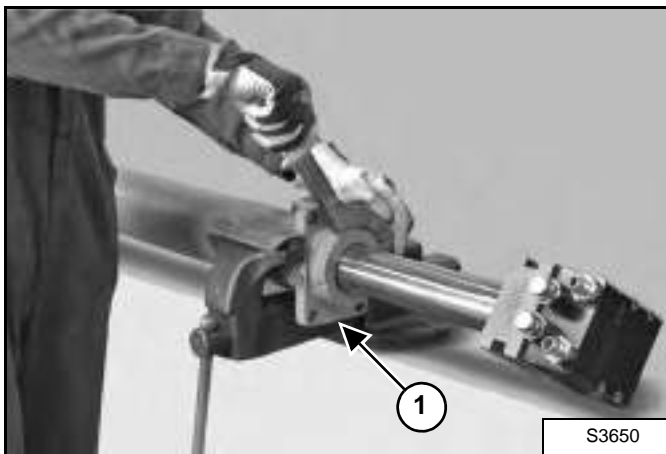

Put the cylinder in a vise.

Use the spanner wrench to loosen the head gland (Item 1) [Figure 20-40-11].

### Assembly

Use the following tools to disassemble the cylinder:

Spanner Wrench

Cylinder Wrench

Rod Seal Installation Tool

Wash the cylinder parts in solvent and dry with compressed air.

Inspect the cylinder parts for nicks, scratches or other damage. Replace any damaged parts.

Lubricate all O-rings and seals with hydraulic oil during installation. Always use new O-rings and seals.

Clean off any old residue, and apply LOCTITE 242 or equivalent to the threads on the piston (Item 8) (See "Parts Identification" on page 20-40-4).



**Bobcat®**

## TILT CYLINDER

### Removal And Installation

Figure 20-50-1

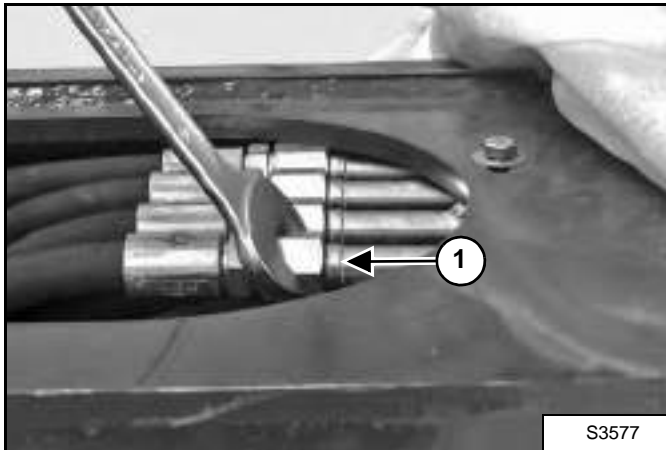

Disconnect the four hydraulic hoses (Item 1) [Figure 20-50-1] at the front of the boom.

**NOTE:** Mark the hoses for correct installation.

# IMPORTANT

When repairing hydrostatic and hydraulic systems, clean the work area before disassembly and keep all parts clean. Always use caps and plugs on hoses, tubelines and ports to keep dirt out. Dirt can quickly damage the system.

I-2003-0888

Figure 20-50-2

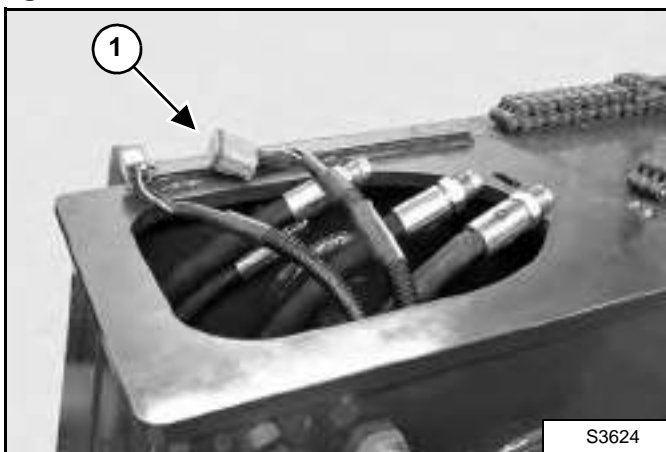

Disconnect the two connectors (Item 1) [Figure 20-50-2] at the front of the boom (If Equipped).

Figure 20-50-3

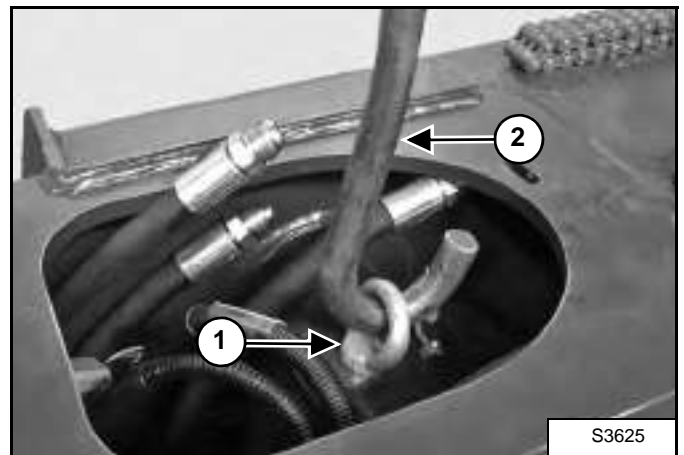

Install a lifting eye (Item 1) on the top of the tilt cylinder, then connect the eye with a lifting chain (Item 2) [Figure 20-50-3].

Figure 20-50-4

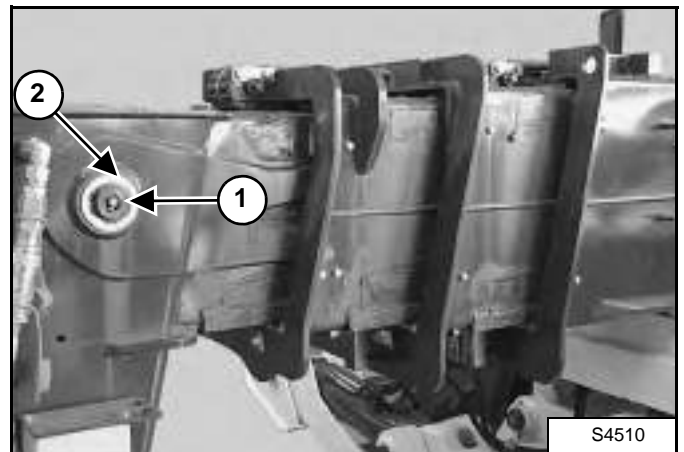

Remove the upper pivot pin snap ring (Item 1) [Figure 20-50-4] at both sides of the pivot pin.

Remove the upper pivot pin washer (Item 2) [Figure 20-50-4] at both sides of the pivot pin.

## TILT CYLINDER (CONT'D)

### Removal And Installation (Cont'd)

Figure 20-50-5

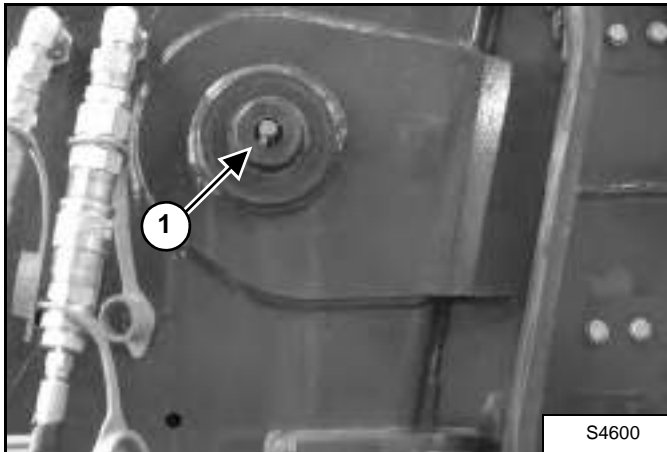

Remove the upper pivot pin (Item 1) [Figure 20-50-5].

Figure 20-50-6

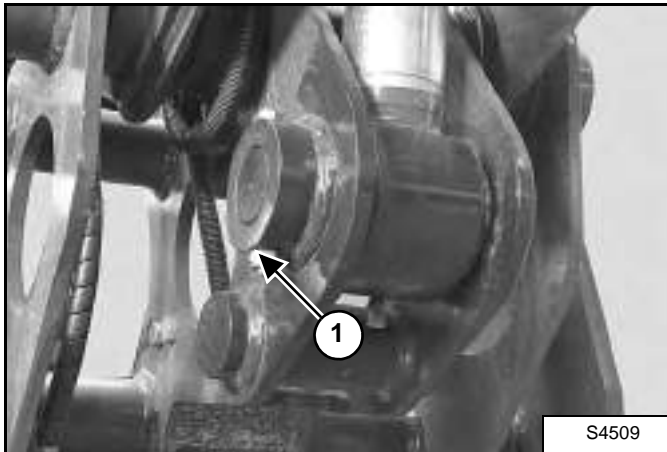

Remove the pivot pin retainer bolt (Item 1) [Figure 20-50-6].

Figure 20-50-7

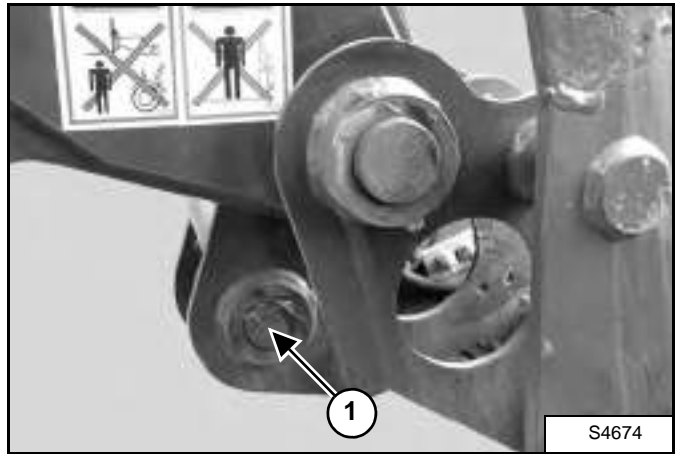

Remove the lower pivot pin (Item 1) [Figure 20-50-7].

Figure 20-50-8

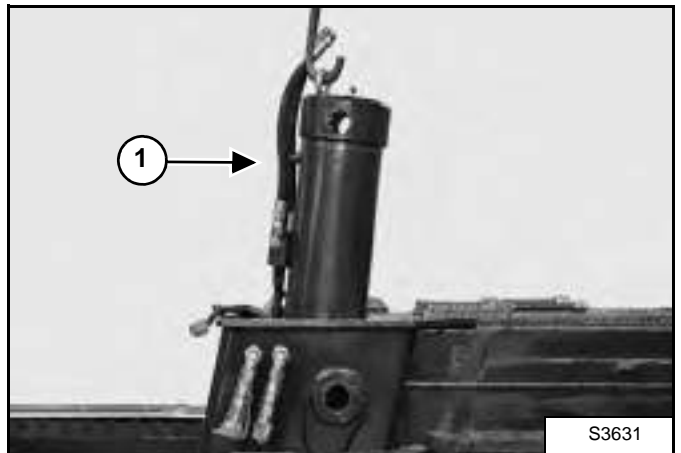

Carefully lift and remove the tilt cylinder (Item 1) [Figure 20-50-8].

# TILT CYLINDER (CONT'D)

## Parts Identification

- 1. Cylinder assy
- 2. Rod
- 3. Bushing
- 4. Grease nipple
- 5. Cap grease nipple
- 6. Piston
- 7. Screw
- 8. Cylinder body
- 9. Cylinder head
- 10. Nut
- 11. Lock valve
- 12. Inner ring
- 13. Seals kit

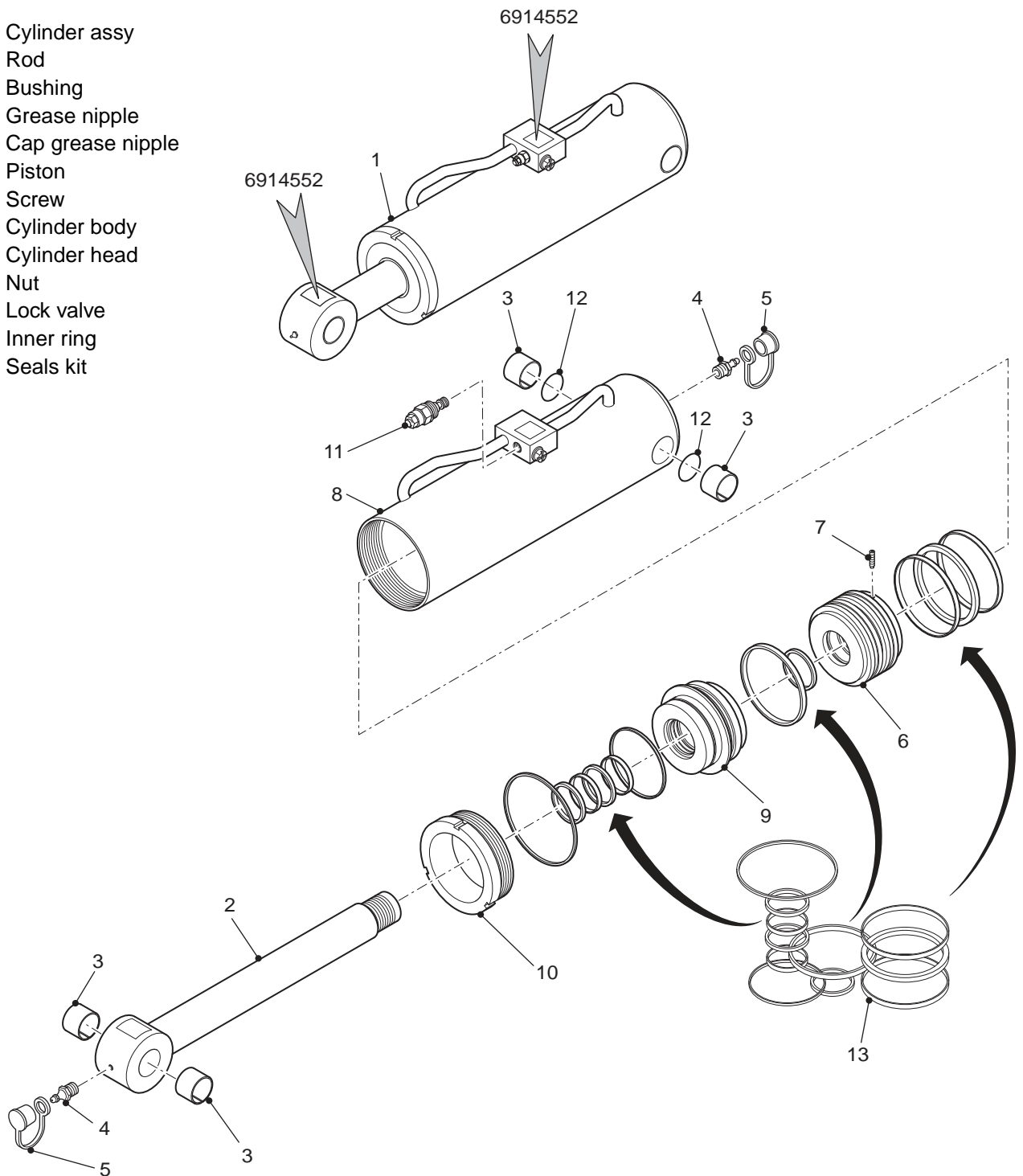

S4705

## TILT CYLINDER (CONT'D)

### Disassembly

Use the following tool to disassemble the cylinder:

MEL1075-Adjustable Gland Wrench

Put the cylinder in a vise.

**Figure 20-50-9**

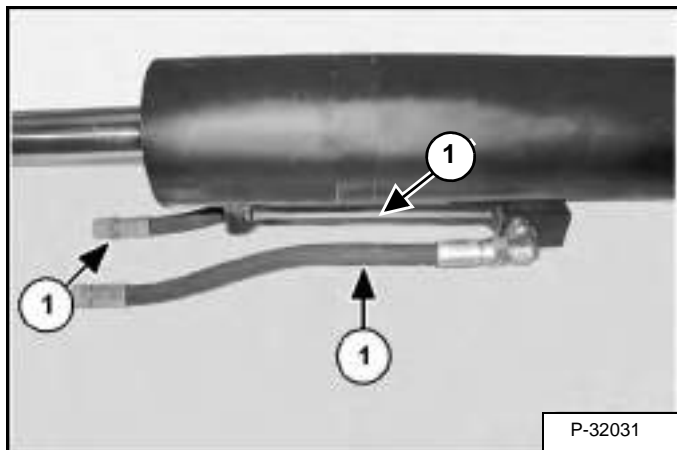

Remove the two hoses (Item 1) [Figure 20-50-9] from the cylinder.

**Figure 20-50-10**

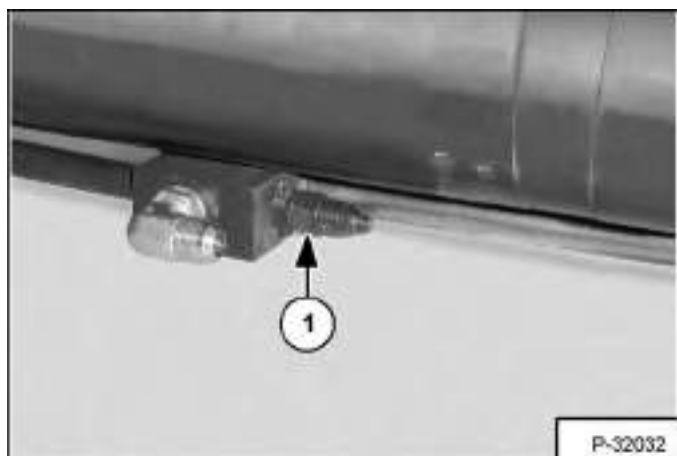

Remove the relief cartridge (Item 1) [Figure 20-50-10].

**Figure 20-50-11**

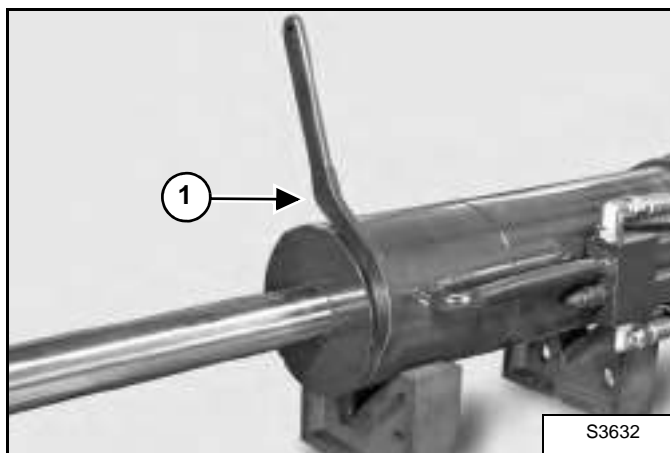

Loosen the head gland (Item 1) [Figure 20-50-11].

### Assembly

Use the following tool to assemble the cylinder:

MEL1075-Adjustable Gland Nut Wrench

Wash the cylinder parts in solvent and dry with compressed air.

Inspect the cylinder parts for damage. Replace any damaged parts.

Lubricate all O-rings and seals with hydraulic oil during installation. Always use new O-rings and seals.

Clean off any old residue, and apply LOCTITE 242 or equivalent to the threads on the rod (Item 2) (See "Parts Identification" on page20-50-3).

Apply LOCTITE 242 or equivalent to the set screw (Item 7) (See "Parts Identification" on page20-50-3).

## STEERING CYLINDER (FRONT)

### Removing the Steering Cylinder

**NOTE:** It is not necessary to remove the front axle for the removal of the steering cylinder. In this procedure images are shown after removal of the front axle to give a better view.

Figure 20-60-1

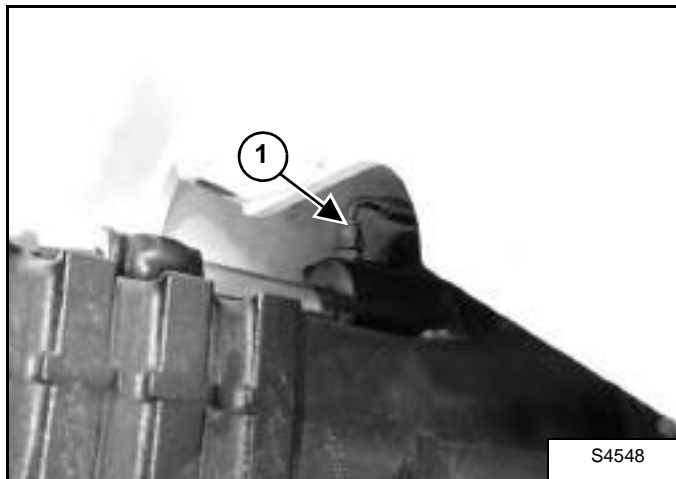

Disconnect the hydraulic tubeline (Item 1) [Figure 20-60-1] from the steering cylinder.

Figure 20-60-2

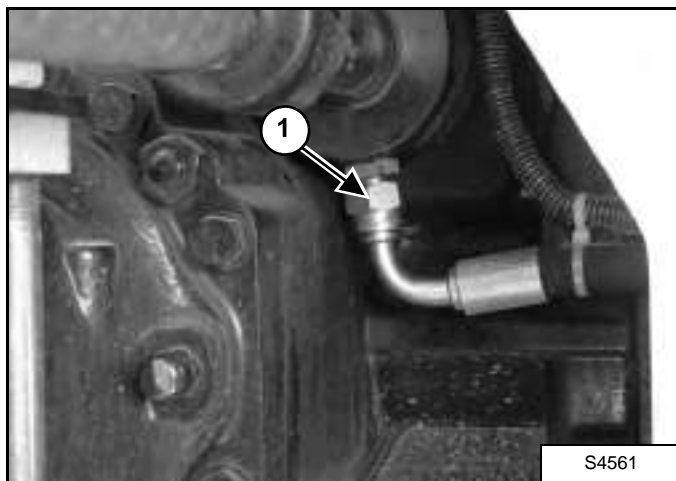

Disconnect the hydraulic tubeline (Item 1) [Figure 20-60-2] from the bottom of the steering cylinder.

Figure 20-60-3

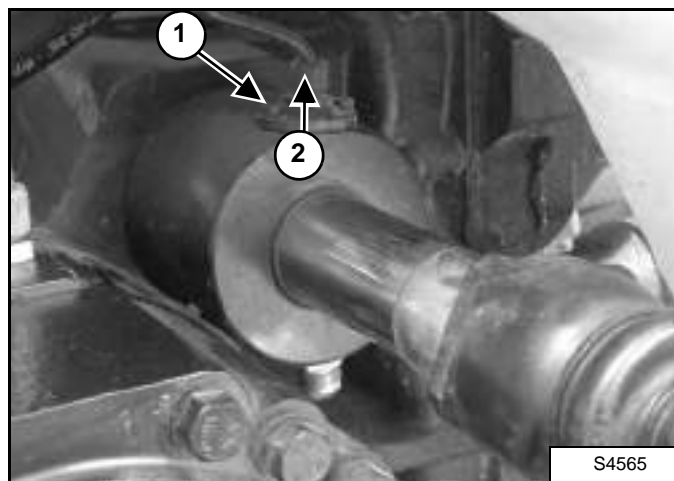

Remove the two bolts (Item 1) and remove the centering sensor (Item 2) [Figure 20-60-3] from the front steering cylinder.

**Installation:** tighten the bolts (Item 2) [Figure 20-60-3] to 3.7 - 4.4 ft.-lb. (5 - 6 N•m) torque.

Figure 20-60-4

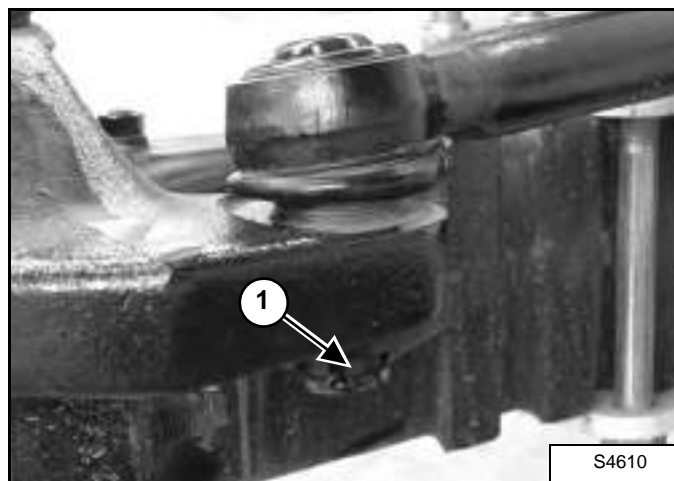

Remove the cotter pin (Item 1) [Figure 20-60-4].

**Installation:** Use new cotter pins.

## STEERING CYLINDER (FRONT) (CONT'D)

### Removing the Steering Cylinder (Cont'd)

Figure 20-60-5

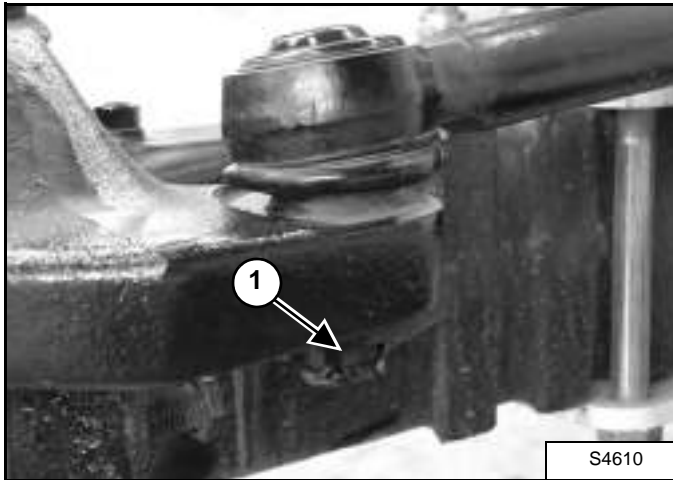

Remove the nut (Item 1) [Figure 20-60-5].

Figure 20-60-6

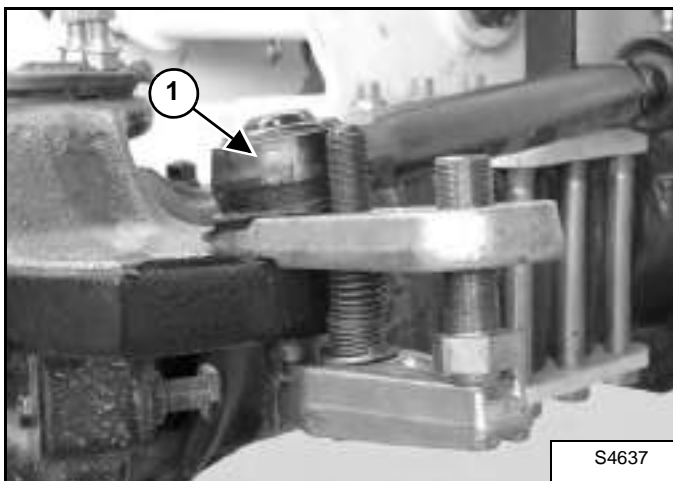

Remove the tie rod end (Item 1) [Figure 20-60-6] by means of a puller.

**Installation:** Insert the pins (Item 1) [Figure 20-60-6] in the steering case and lock into position of 192 - 214 ft.-lb. (260 - 290 N•m) torque.

Figure 20-60-7

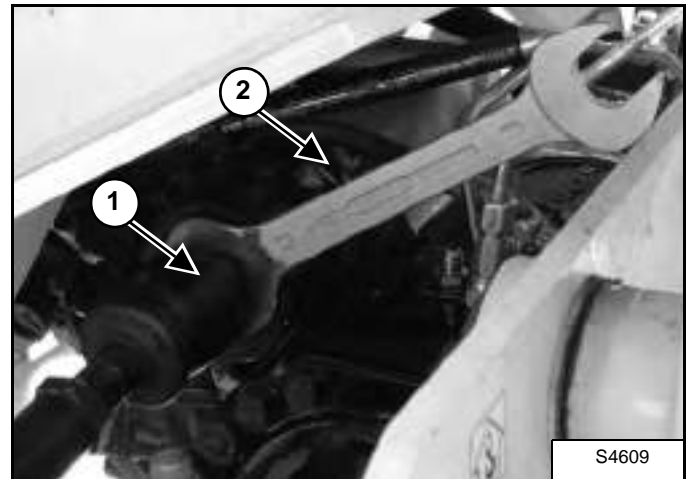

Disconnect the left and right steering bars (Item 1) from the piston (Item 2) [Figure 20-60-7].

**Installation:** Apply Loctite 242 to the thread and connect the steering bars by screwing the terminals onto the piston stem, apply a torque of 177 - 200 ft.-lb. (240 - 270 N•m).

Figure 20-60-8

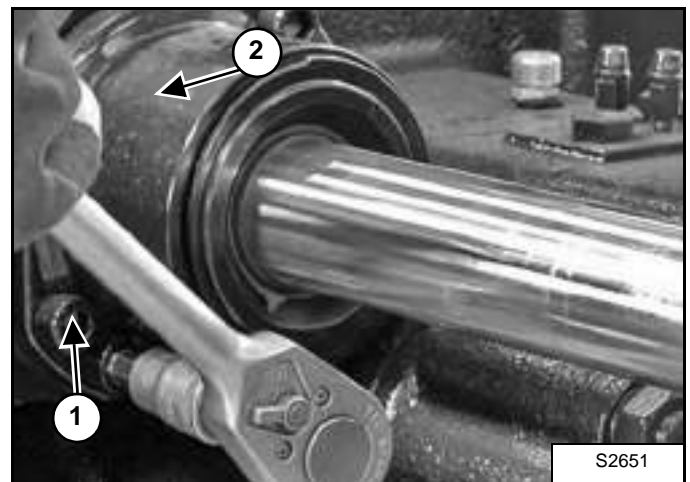

Remove the securing screws (Item 1) from the steering cylinder (Item 2) [Figure 20-60-8].

**Installation:** Tighten the bolts (Item 1) [Figure 20-60-8] to 85 - 95 ft.-lb. (116 - 128 N•m) torque.

Extract the cylinder using a plastic hammer.

**NOTE:** For cylinder disassembly See "Disassembling the Steering Cylinder" on page 20-60-3.



## STEERING CYLINDER (FRONT) (CONT'D)

### Disassembling the Steering Cylinder

Figure 20-60-9

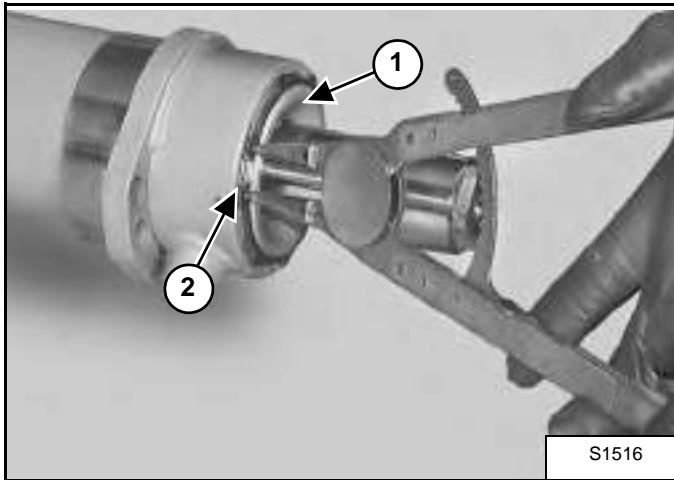

Remove the snap ring (Item 1) from the cylinder head (Item 2) [Figure 20-60-9].

Figure 20-60-10

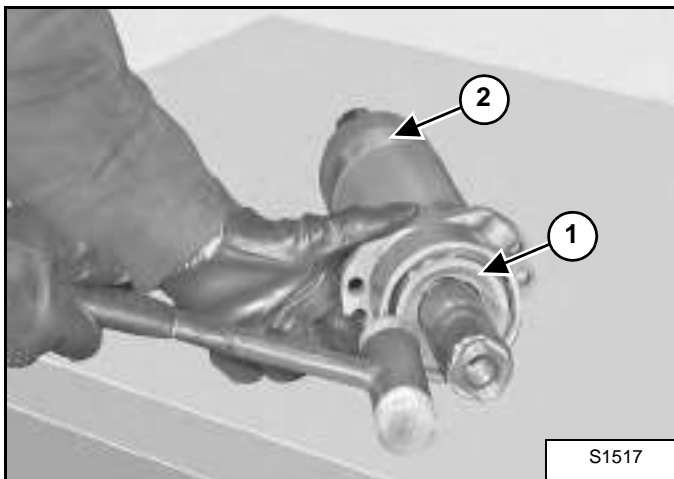

With the help of a plastic hammer, push the head (Item 1) inside the cylinder (Item 2) [Figure 20-60-10].

**NOTE:** The head should line up with the edge of the cylinder.

Figure 20-60-11

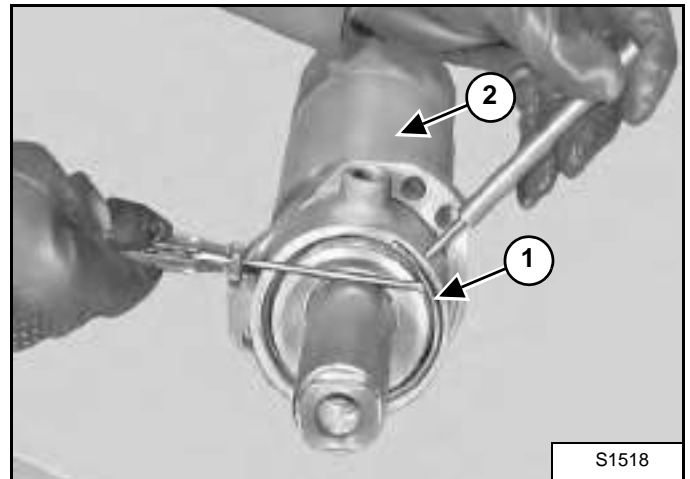

With the help of a drift, apply pressure to the stop ring (Item 1) that is placed inside the cylinder (Item 2) [Figure 20-60-11] and extract the ring using a screwdriver.

Figure 20-60-12

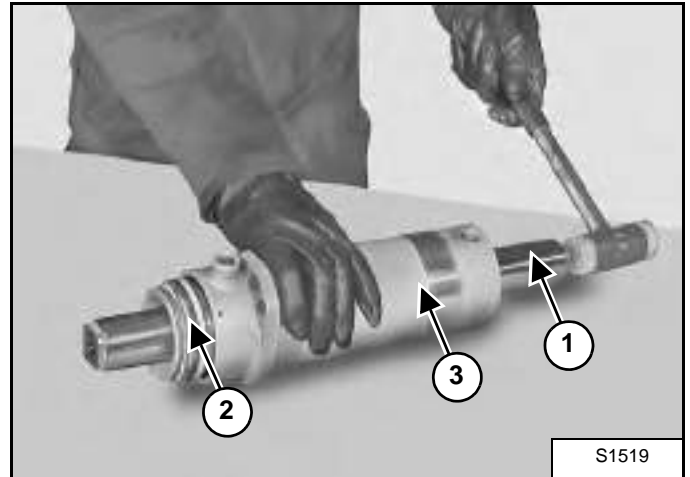

Hammer the piston (Item 1) on the rear of the head (Item 2) [Figure 20-60-12] using a plastic hammer.

Continue hammering until the head (Item 2) is ejected from the cylinder (Item 3) [Figure 20-60-12].

## STEERING CYLINDER (FRONT) (CONT'D)

### Disassembling the Steering Cylinder (Cont'd)

Figure 20-60-13

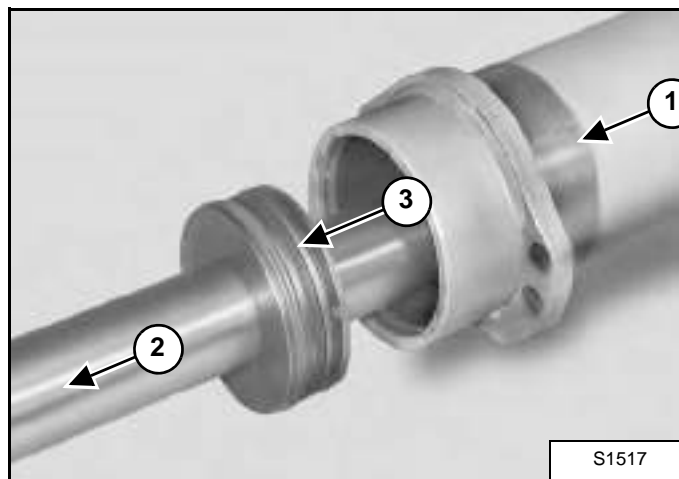

Disassemble the cylinder unit (Item 1) by extracting first the head (Item 2) then the piston (Item 3) [Figure 20-60-13].

**NOTE:** Note down the assembly side of the piston (Item 3) bevelled part "A" of the piston is oriented towards the head (Item 2) [Figure 20-60-13].

Remove all seals, anti-extrusion rings and scraper rings from head, cylinder and piston.

**NOTE:** 1) All seals must be replaced every time the unit is disassembled.  
2) Particular attention must be paid not to damage the seats of both seals and piston slide.

## Assembling the Steering Cylinder

Figure 20-60-14

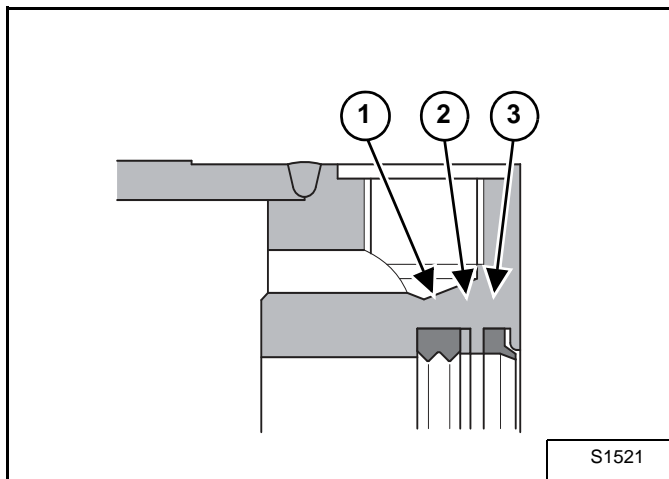

After applying grease, install the sealing ring (Item 1) on the shaft, the anti-extrusion ring (Item 2) and the scraper ring (Item 3) [Figure 20-60-14] inside the cylinder (Item 3) [Figure 20-60-12].

**NOTE:** Thoroughly check that positioning of the anti-extrusion ring (Item 2) [Figure 20-60-14] is correct.

Figure 20-60-15

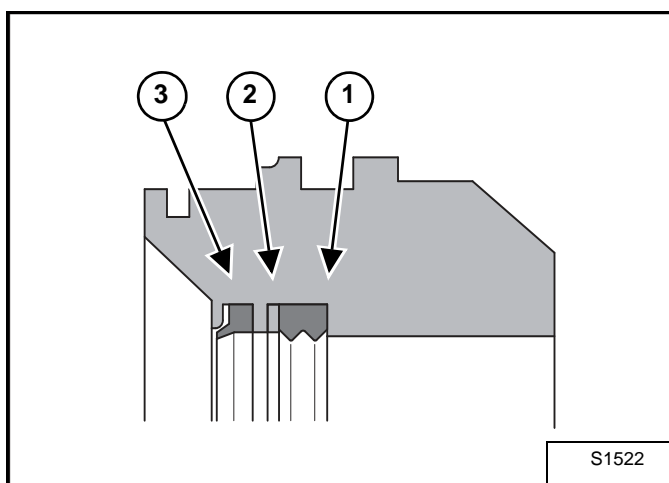

After applying grease, install the sealing ring (Item 1) on the shaft, the anti-extrusion ring (Item 2) and the scraper ring (Item 3) in the head (Item 2) [Figure 20-60-15].

**NOTE:** Thoroughly check that positioning of the anti-extrusion ring (Item 2) [Figure 20-60-15] is correct.

## STEERING CYLINDER (FRONT) (CONT'D)

### Assembling the Steering Cylinder (Cont'd)

Figure 20-60-16

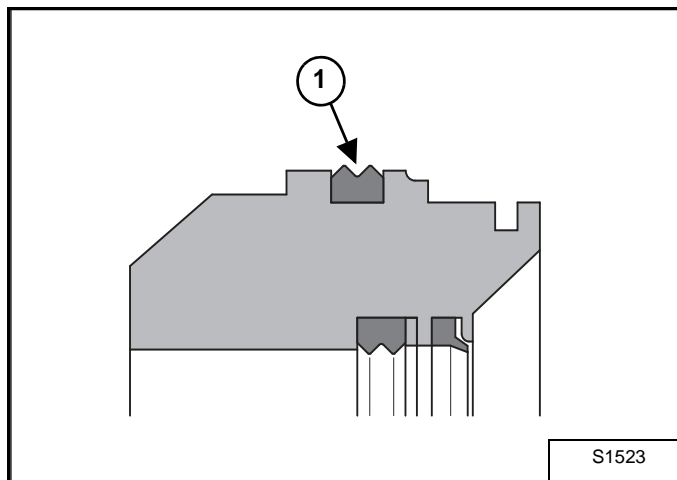

Fit the seal (Item 1) [Figure 20-60-16] onto the outside of the head (Item 2) [Figure 20-60-12].

**NOTE:** In order to facilitate assembly, apply grease to the outer surface of the piston. Do not roll the seal (Item 1) [Figure 20-60-16]

Figure 20-60-17

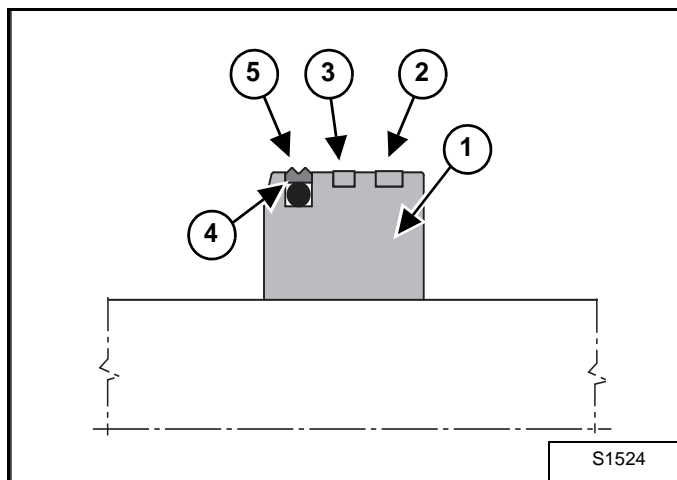

Prepare the piston (Item 1) by fitting it with the guide ring (Item 2), the magnetic ring (Item 3), the O-ring (Item 4) and the seal (Item 5) [Figure 20-60-17].

**NOTE:** In order to facilitate assembly, apply grease.

Figure 20-60-18

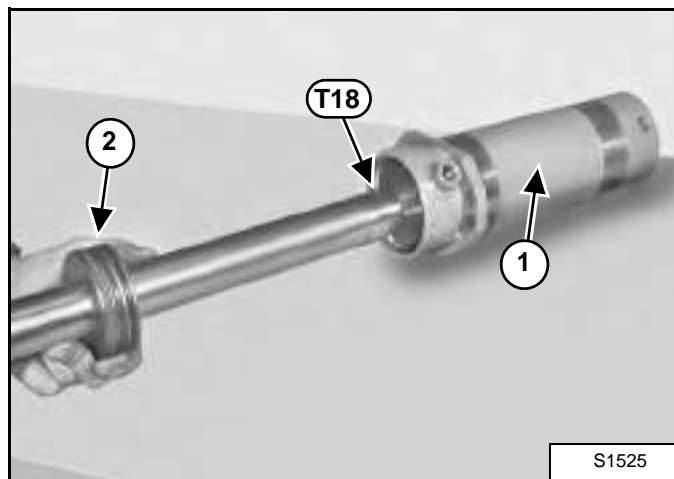

Apply tool **T18** to the shaft on the opposite side of the head (Item 2) and centre it on the cylinder (Item 1) so that it fits into the piston (Item 2) [Figure 20-60-18].

**NOTE:** Apply a little grease to seals and cylinder.

Figure 20-60-19

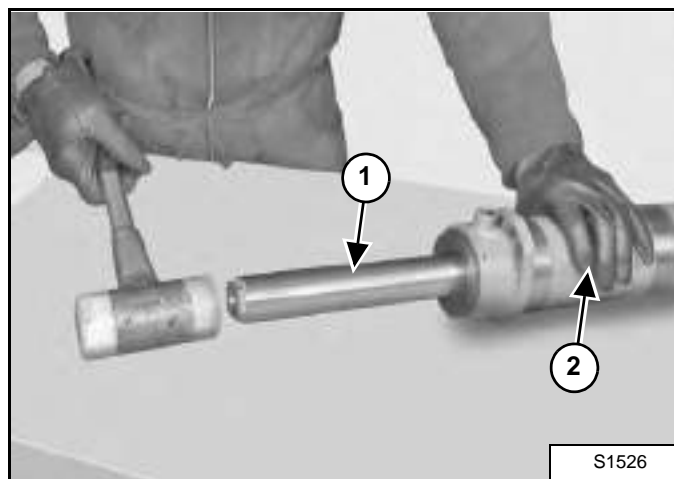

Push the piston (Item 1) into the cylinder (Item 2) [Figure 20-60-19] for 100 mm. using a plastic hammer.

## STEERING CYLINDER (FRONT) (CONT'D)

### Assembling the Steering Cylinder (Cont'd)

Figure 20-60-20

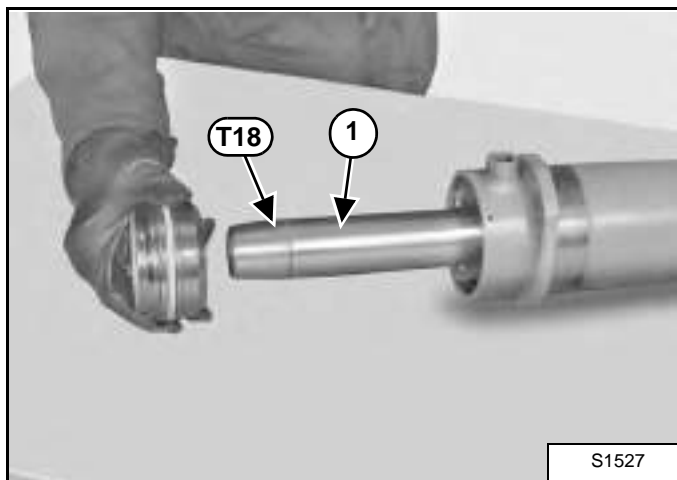

Remove tool **T18** and apply it to the opposite side of the piston (Item 1) **[Figure 20-60-20]**

Figure 20-60-21

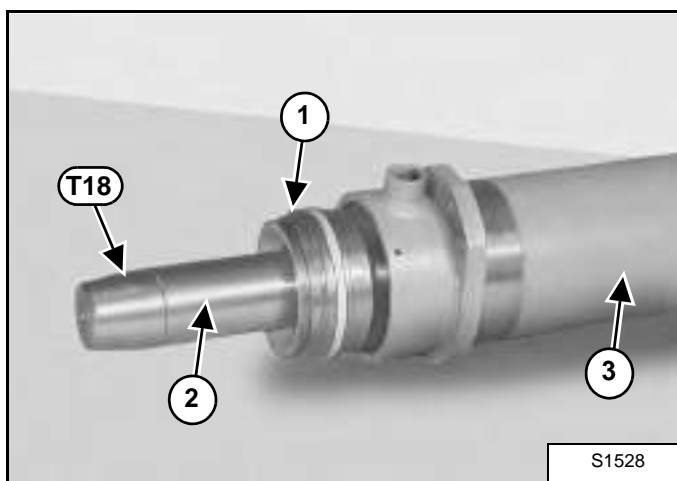

Apply grease to the head (Item 1) seals, fit the head onto the piston and push it onto the cylinder (Item 3) **[Figure 20-60-21]**.

Figure 20-60-22

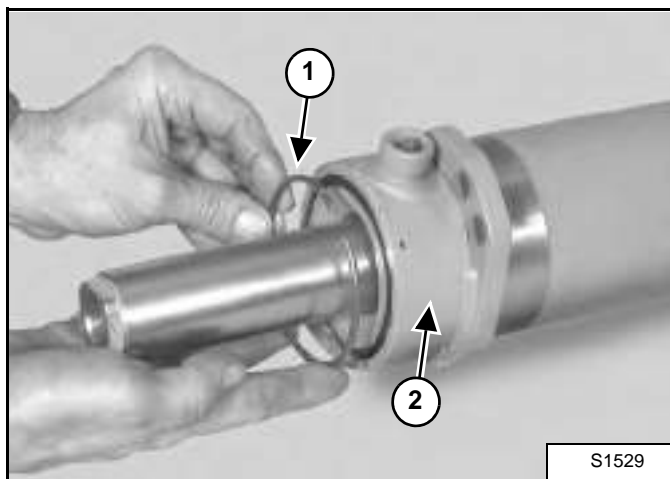

Insert the stop ring (Item 1) ensuring that it fits into the seat of the cylinder (Item 2) **[Figure 20-60-22]**.

Figure 20-60-23

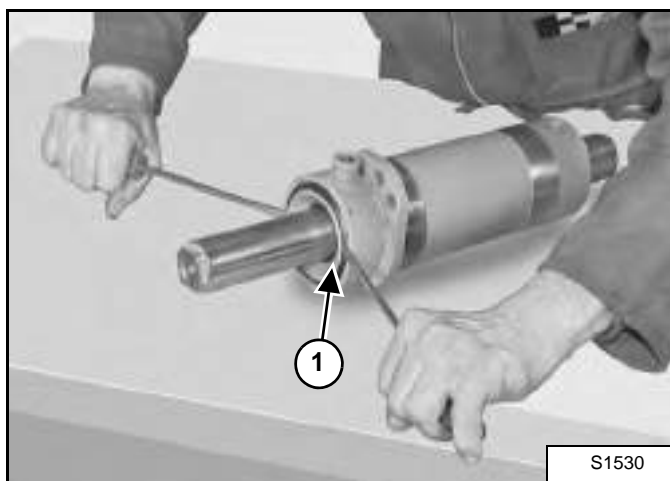

Apply pressure to the head using two screwdrivers or levers until the head is fastened onto the stop ring (Item 1) **[Figure 20-60-23]**.

## STEERING CYLINDER (FRONT) (CONT'D)

### Assembling the Steering Cylinder (Cont'd)

Figure 20-60-24

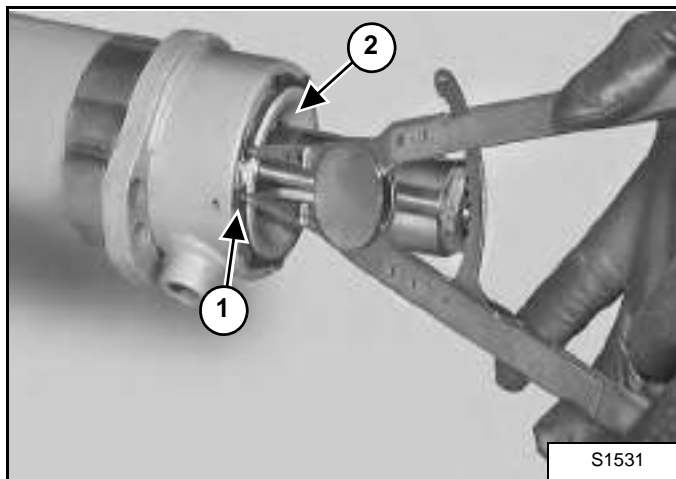

Fit the snap ring (Item 1) on the head (Item 2) [Figure 20-60-24].

**NOTE:** Make sure that the snap ring (Item 1) [Figure 20-60-24] is securely fastened in its seat. If necessary, force it into its seat using a drift and a hammer.



**Bobcat®**

## STEERING CYLINDER (REAR)

### Removing the Steering Cylinder

Figure 20-61-1

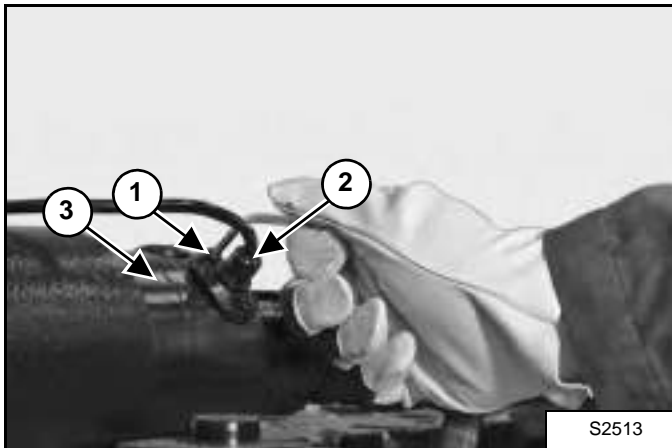

Remove the two bolts (Item 1) and remove the centering sensor (Item 2) from the steering cylinder (Item 3) [Figure 20-61-1].

Figure 20-61-2

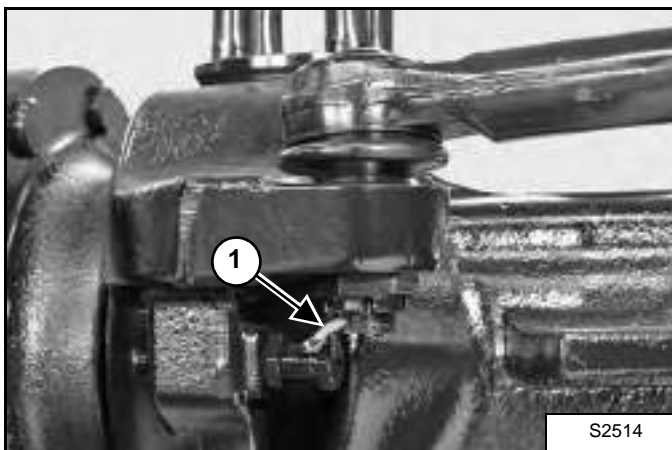

Remove the cotter pin (Item 1) [Figure 20-61-2].

Figure 20-61-3

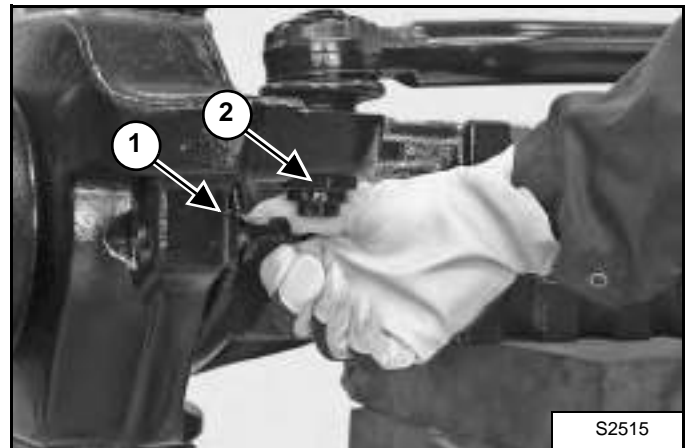

Remove the bolt (Item 1) for access for removing the nut (Item 2) [Figure 20-61-3].

Figure 20-61-4

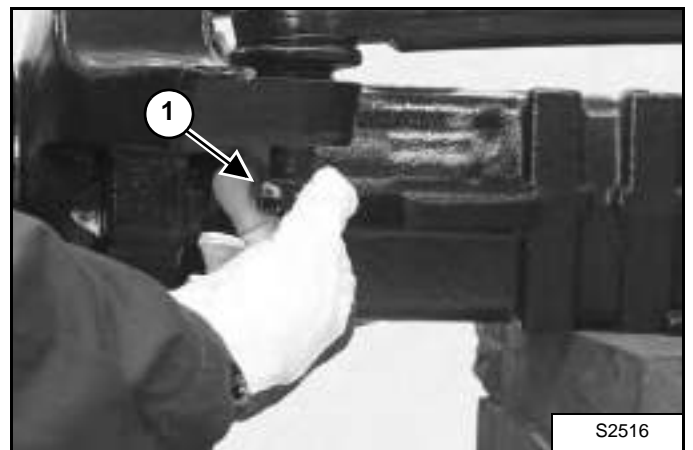

Remove the nut (Item 1) [Figure 20-61-4].

## STEERING CYLINDER (REAR) (CONT'D)

### Removing the Steering Cylinder (Cont'd)

Figure 20-61-5

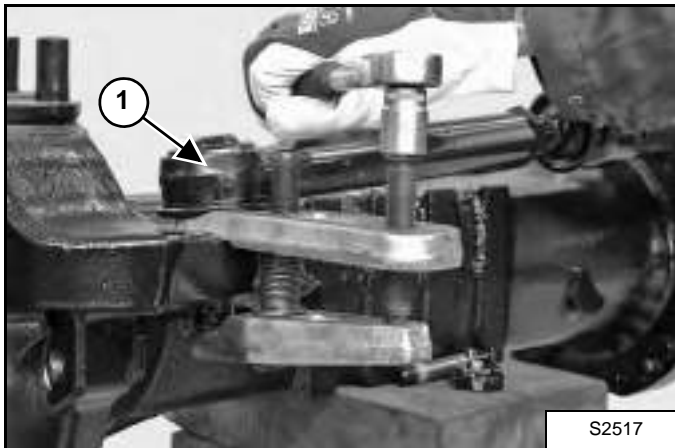

Remove the tie rod end (Item 1) [Figure 20-61-5] by means of a puller.

Figure 20-61-6

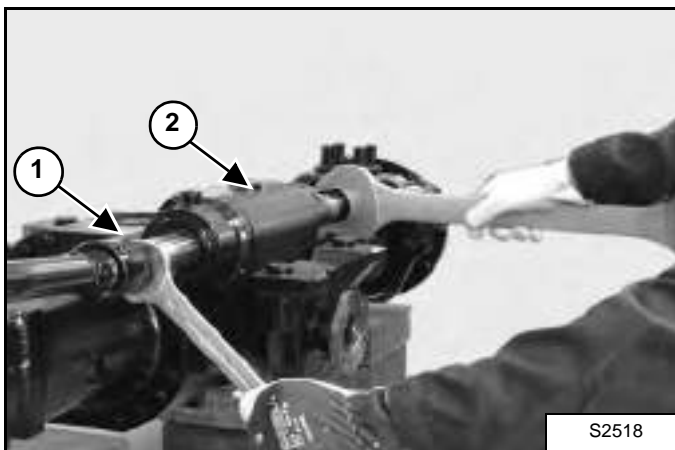

Disconnect the left and right steering bars (Item 1) from the piston (Item 2) [Figure 20-61-6].

Figure 20-61-7

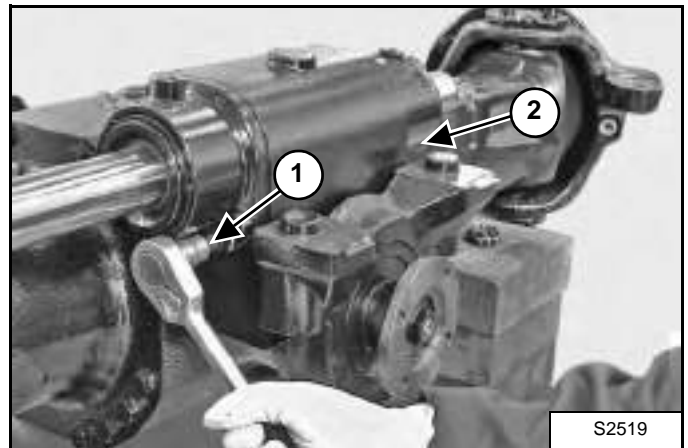

Remove the securing screws (Item 1) from the steering cylinder (Item 2) [Figure 20-61-7].

Figure 20-61-8

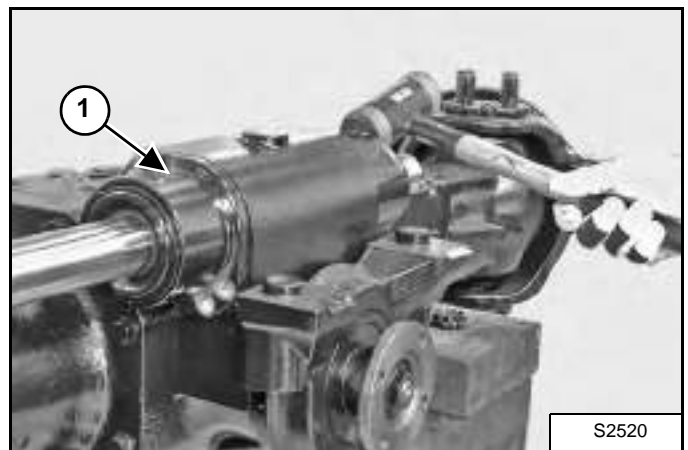

Extract the cylinder (Item 1) [Figure 20-61-8] using a plastic hammer.

**NOTE:** For cylinder disassembly See “Disassembling the Steering Cylinder” on page 20-61-4.



## STEERING CYLINDER (REAR) (CONT'D)

### Installing the Steering Cylinder

Figure 20-61-9

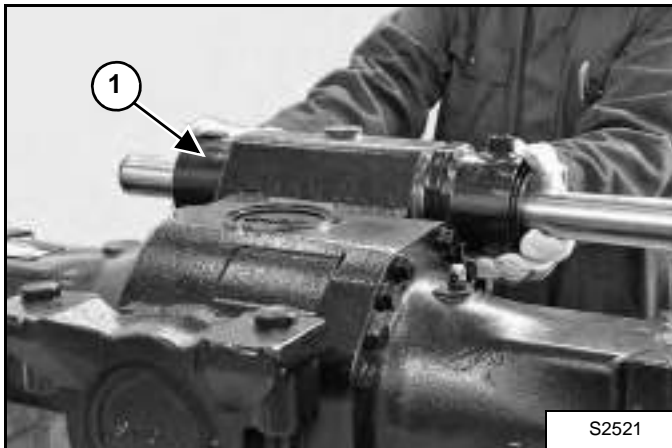

Lubricate the seats of the seals and fit the steering cylinder (Item 1) [Figure 20-61-9] into its seat.

Figure 20-61-10

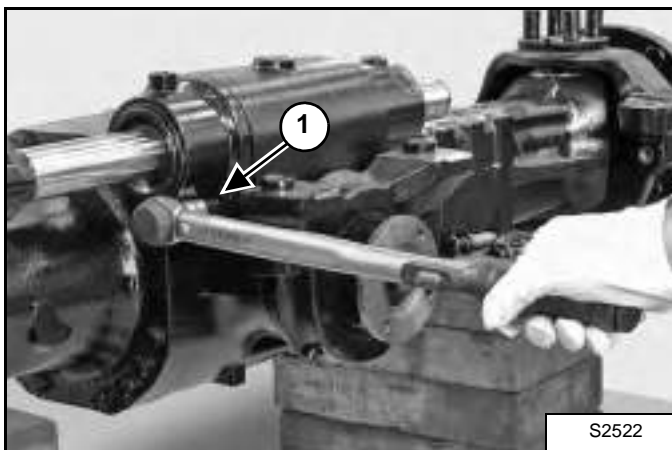

Tighten the bolts (Item 1) [Figure 20-61-10] to 85 - 95 ft.-lb. (116 - 128 N•m) torque.

Figure 20-61-11



Apply Loctite 242 to the thread and connect the steering bars by screwing the terminals onto the piston stem, tighten to 170 - 200 ft.-lb. (240 - 270 N•m) torque.

Figure 20-61-12

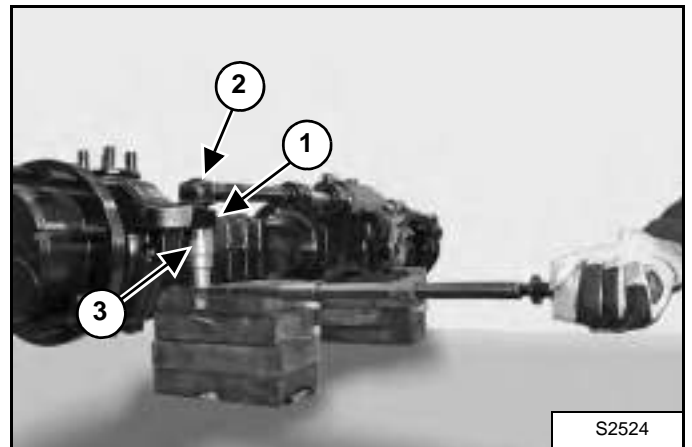

Insert the pins (Item 1) in the steering case (Item 2) [Figure 20-61-12] and tighten to 192 - 214 ft.-lb. (260 - 290 N•m) torque.

Find the position of the notching in relation to the hole of the cotter pins and tighten the nut (Item 3) [Figure 20-61-12] further.

**NOTE:** Check that the rubber guards [Figure 20-61-12] are intact.

## STEERING CYLINDER (REAR) (CONT'D)

### Installing the Steering Cylinder (Cont'd)

Figure 20-61-13

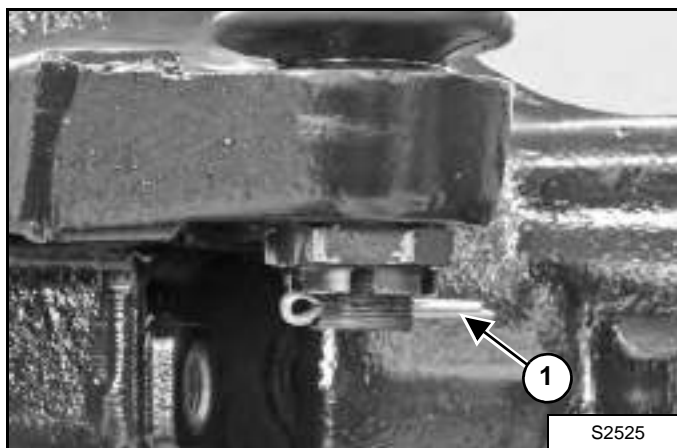

Insert the cotter pins (Item 1) [Figure 20-61-13] and bend the ends.

**NOTE:** Use new cotter pins.

Figure 20-61-14

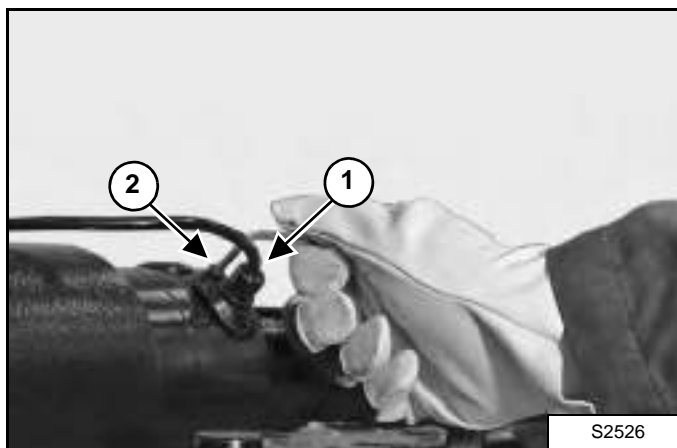

Install the centering sensor (Item 1) for checking piston centering and tighten the bolts (Item 2) [Figure 20-61-14] to 3.7 - 4.4 ft.-lb. (5 - 6 N•m) torque.

After the axle has been reinstalled on the machine, perform the axle toe-in procedure (See "AXLE TOE-IN" on page 40-40-1)

## Disassembling the Steering Cylinder

Figure 20-61-15

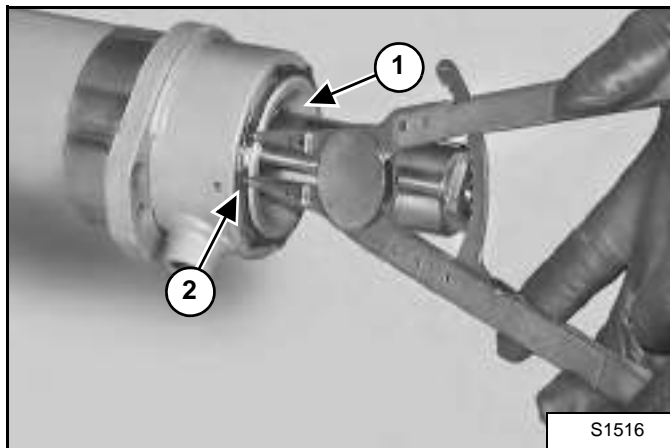

Remove the snap ring (Item 1) from the cylinder head (Item 2) [Figure 20-61-15],

Figure 20-61-16

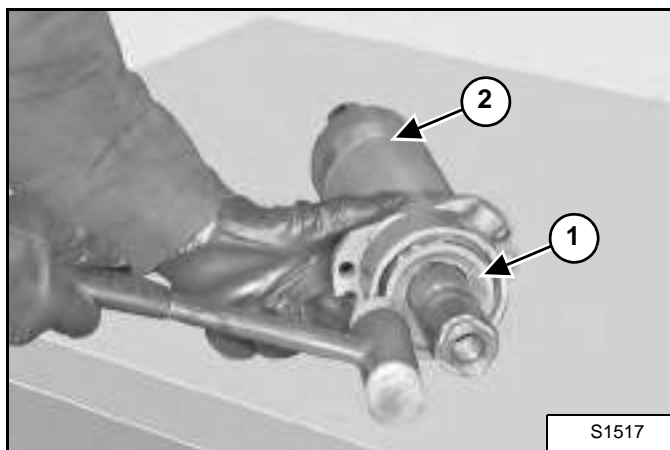

With the help of a plastic hammer, push the head (Item 1) inside the cylinder (Item 2) [Figure 20-61-16],

**NOTE:** The head should line up with the edge of the cylinder.

## STEERING CYLINDER (REAR) (CONT'D)

### Disassembling the Steering Cylinder (Cont'd)

Figure 20-61-17

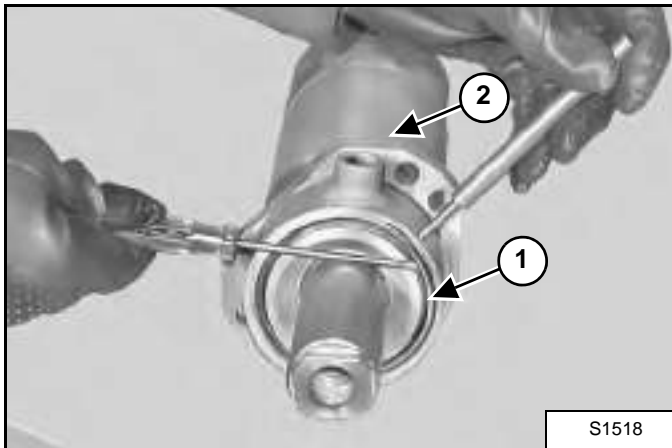

With the help of a drift, apply pressure to the stop ring (Item 1) that is placed inside the cylinder (Item 2) [Figure 20-61-17] and extract the ring using a screwdriver.

Figure 20-61-18

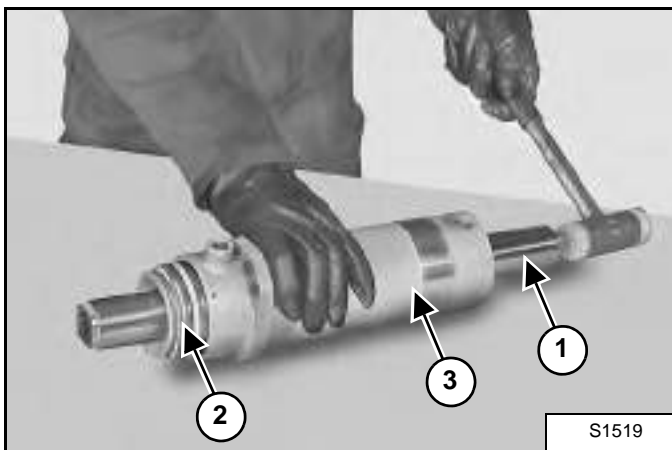

Hammer the piston (Item 1) on the rear of the head (Item 2) [Figure 20-61-18] using a plastic hammer.

Continue hammering until the head (Item 2) is ejected from the cylinder (Item 3) [Figure 20-61-18].

Figure 20-61-19

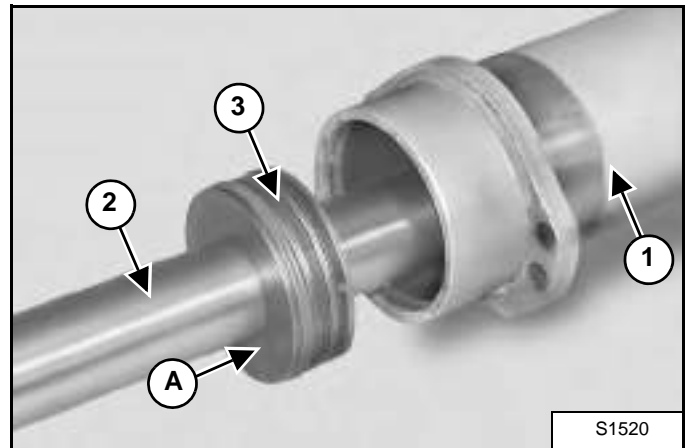

Disassemble the cylinder unit (Item 1) by extracting first the head (Item 2) then the piston (Item 3) [Figure 20-61-19].

**NOTE:** Note down the assembly side of the piston (Item 3). The bevelled part "A" of the piston is oriented towards the head (Item 2) [Figure 20-61-19].

Remove all seals, anti-extrusion rings and scraper rings from head, cylinder and piston.

**NOTE:** 1) All seals must be replaced every time the unit is disassembled.  
2) Particular attention must be paid not to damage the seats of both seals and piston slide.

## STEERING CYLINDER (REAR) (CONT'D)

### Assembling the Steering Cylinder

Figure 20-61-20

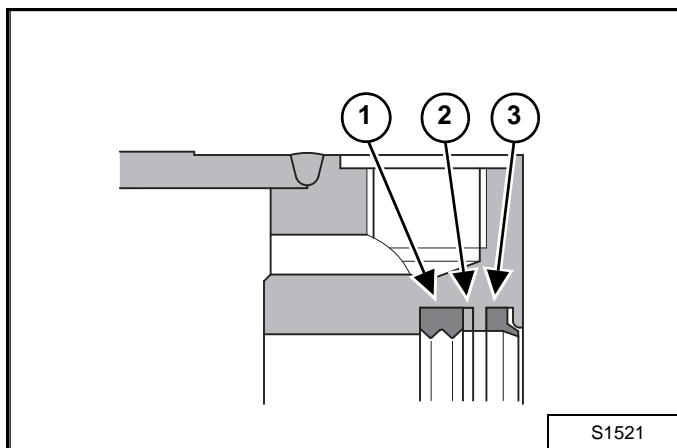

After applying grease, install the sealing ring (Item 1) on the shaft, the anti-extrusion ring (Item 2) and the scraper ring (Item 3) [Figure 20-61-20] inside the cylinder (Item 3) [Figure 20-61-18].

**NOTE:** Thoroughly check that positioning of the anti-extrusion ring (Item 2) [Figure 20-61-20] is correct.

Figure 20-61-21

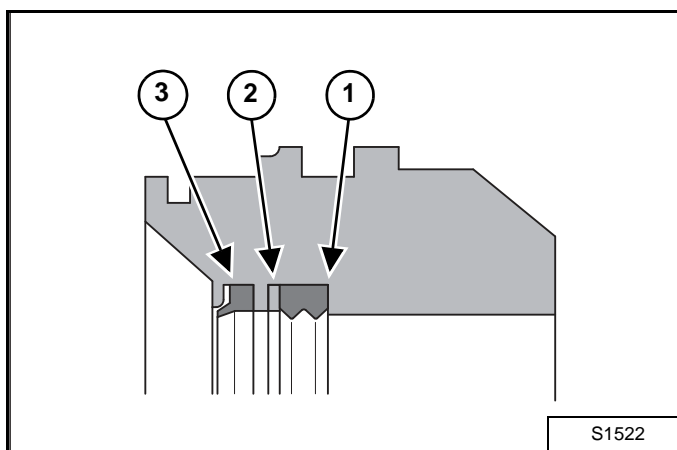

After applying grease, install the sealing ring (Item 1) on the shaft, the anti-extrusion ring (Item 2) and the scraper ring (Item 3) [Figure 20-61-21] in the head (Item 2) [Figure 20-61-19].

**NOTE:** Thoroughly check that positioning of the anti-extrusion ring (Item 2) [Figure 20-61-21] is correct.

Figure 20-61-22

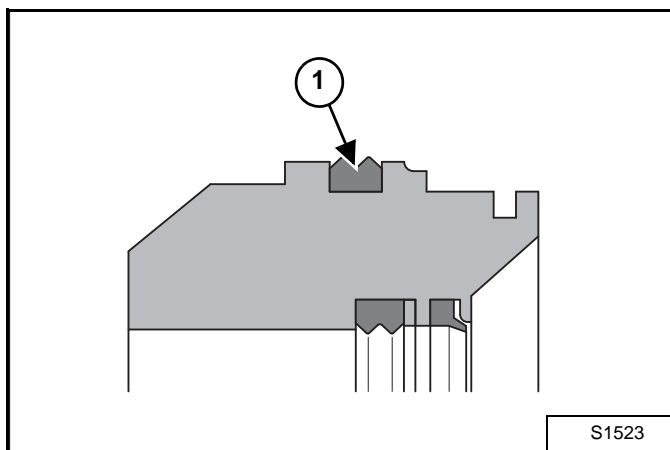

Fit the seal (Item 1) [Figure 20-61-22] onto the outside of the head (Item 2) [Figure 20-61-19].

**NOTE:** In order to facilitate assembly, apply grease to the outer surface of the piston. Do not roll the seal (Item 1) [Figure 20-61-22]

Figure 20-61-23

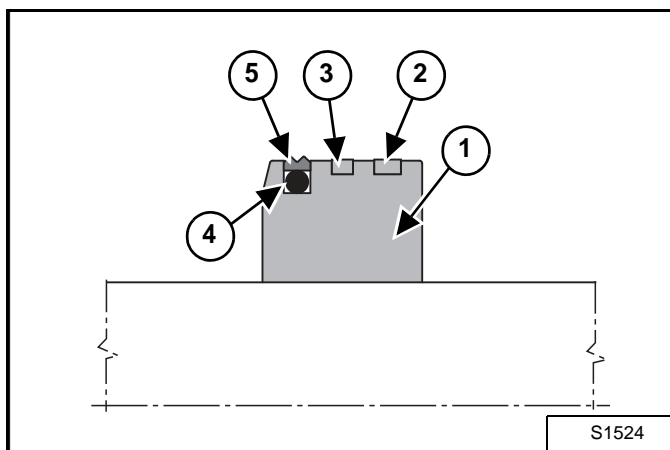

Prepare the piston (Item 1) by fitting it with the guide ring (Item 2), the magnetic ring (Item 3), the O-ring (Item 4) and the seal (Item 5) [Figure 20-61-23].

**NOTE:** In order to facilitate assembly, apply grease.

## STEERING CYLINDER (REAR) (CONT'D)

### Assembling the Steering Cylinder (Cont'd)

Figure 20-61-24

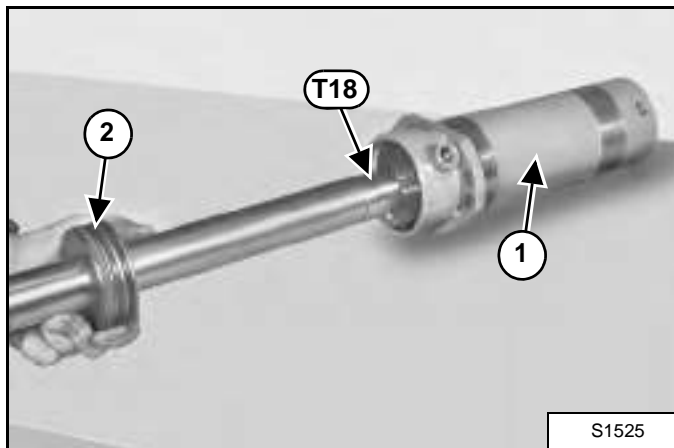

Apply tool **T18** to the shaft on the opposite side of the head (Item 2) and centre it on the cylinder (Item 1) so that it fits into the piston (Item 2) [Figure 20-61-24].

**NOTE:** Apply a little grease to seals and cylinder.

Figure 20-61-25

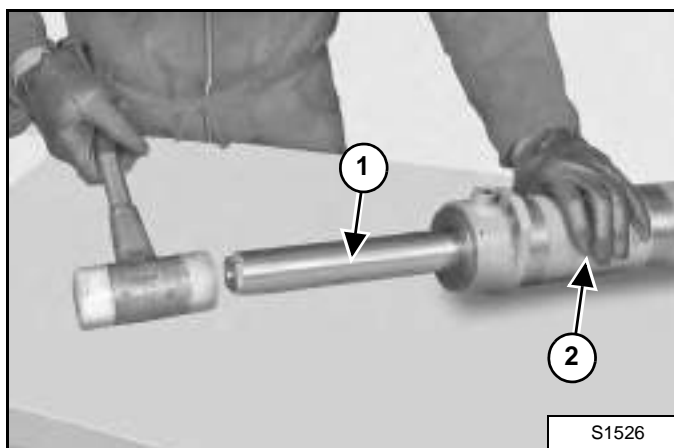

Push the piston (Item 1) into the cylinder (Item 2) [Figure 20-61-25] for 100 MM. using a plastic hammer.

Figure 20-61-26

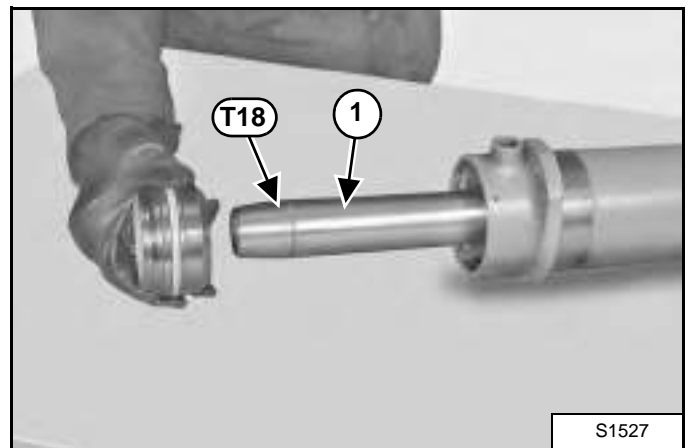

Remove tool **T18** and apply it to the opposite side of the piston (Item 1) [Figure 20-61-26]

Figure 20-61-27

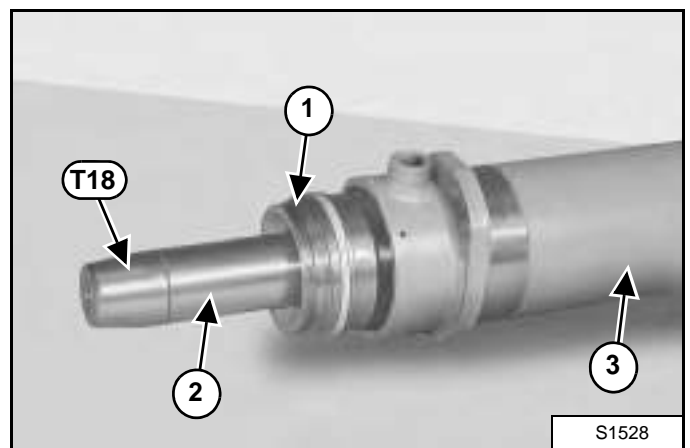

Apply grease to the head (Item 1) seals, fit the head onto the piston and push it onto the cylinder (Item 3) [Figure 20-61-27].

## STEERING CYLINDER (REAR) (CONT'D)

### Assembling the Steering Cylinder (Cont'd)

Figure 20-61-28

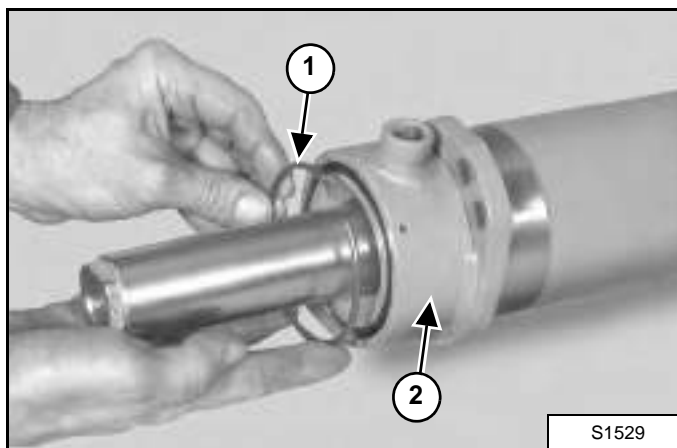

Insert the stop ring (Item 1) ensuring that it fits into the seat of the cylinder (Item 2) [Figure 20-61-28].

Figure 20-61-29

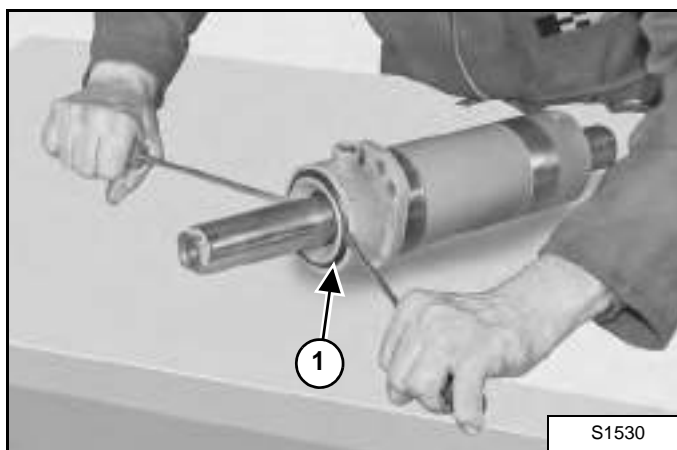

Apply pressure to the head using two screwdrivers or levers until the head is fastened onto the stop ring (Item 1) [Figure 20-61-29].

Figure 20-61-30

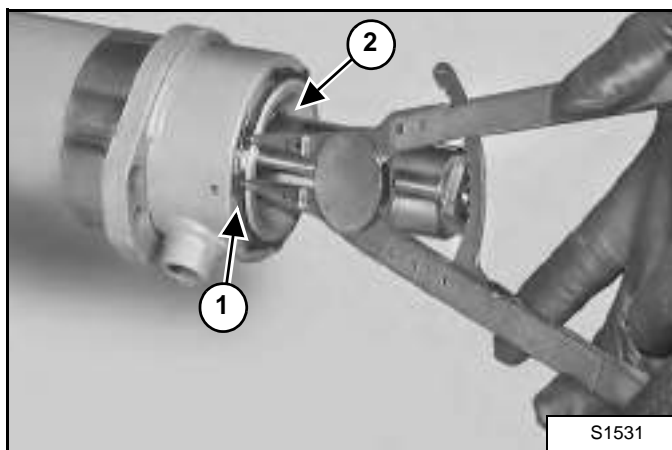

Fit the snap ring (Item 1) on the head (Item 2) [Figure 20-61-30].

**NOTE:** Make sure that the snap ring (Item 1) [Figure 20-61-30] is securely fastened in its seat. If necessary, force it into its seat using a drift and a hammer.

# DRIVE BOX

## Parts Identification

Figure 20-70-1

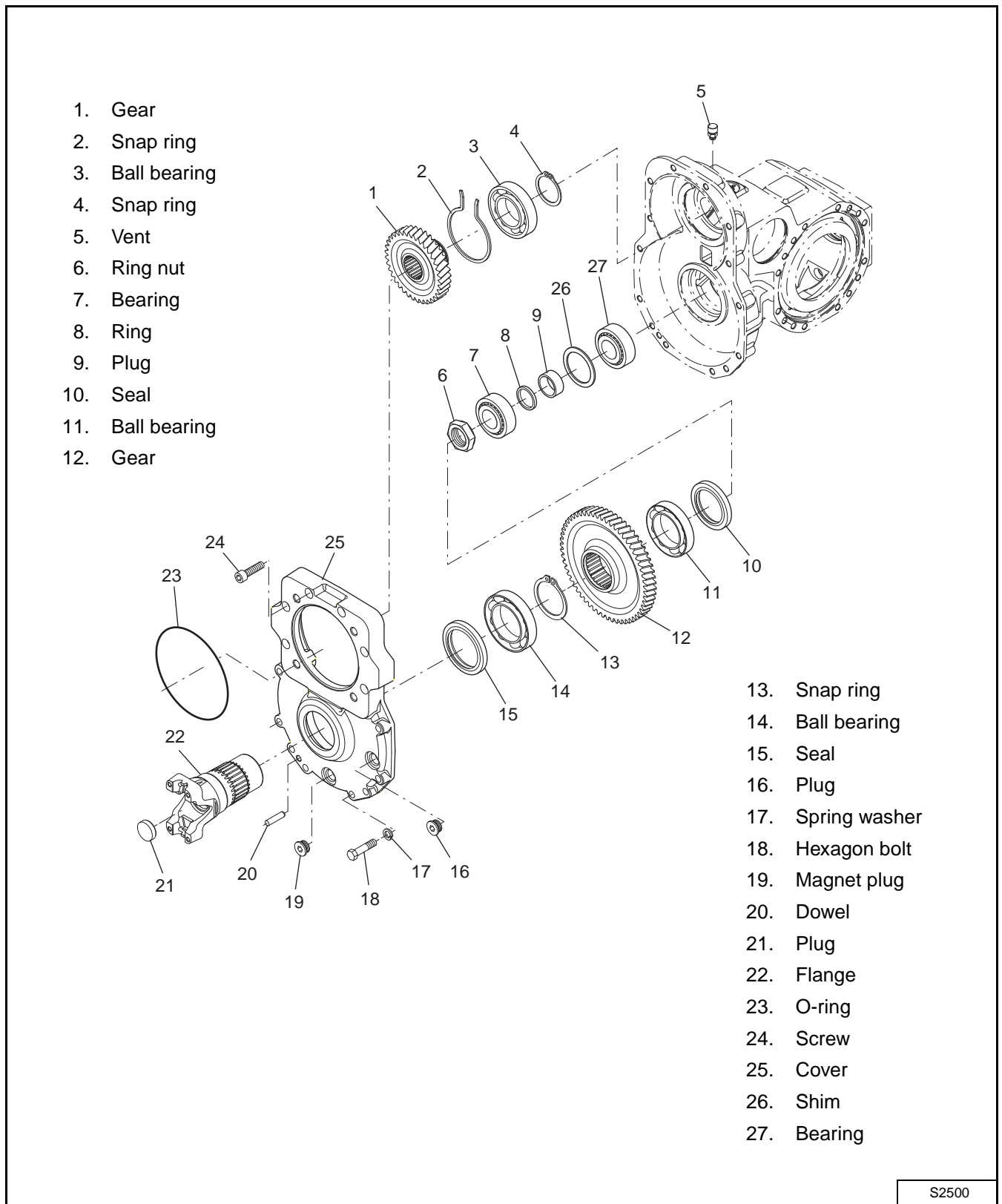

S2500

## DRIVE BOX (CONT'D)

### Disassembly

Remove the front axle. (See "Removal" on page 40-30-1)

Remove the drive motor. (See "Removal And Installation" on page 30-30-1.)

**Figure 20-70-2**

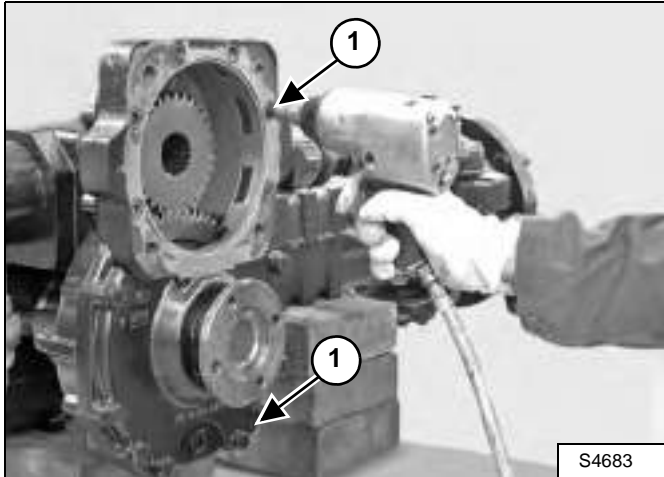

Loosen the securing bolts (Item 1) [Figure 20-70-2] only so that later when you pry the drive side flange cover loose, it does not fall.

**Figure 20-70-3**

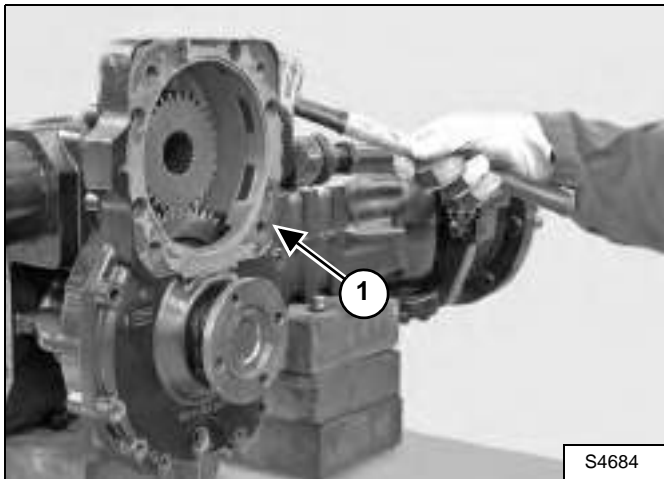

Loosen the drive side flange cover (Item 1) [Figure 20-70-3] using a plastic hammer.

**Figure 20-70-4**

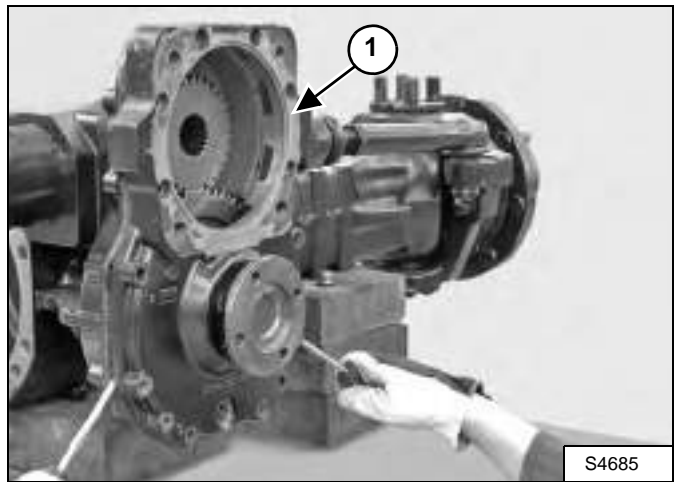

Take off the drive side flange cover (Item 1) [Figure 20-70-4] by alternatively forcing a screwdriver into the appropriate slots.

**NOTE:** Look out not to damage the surfaces.

**Figure 20-70-5**

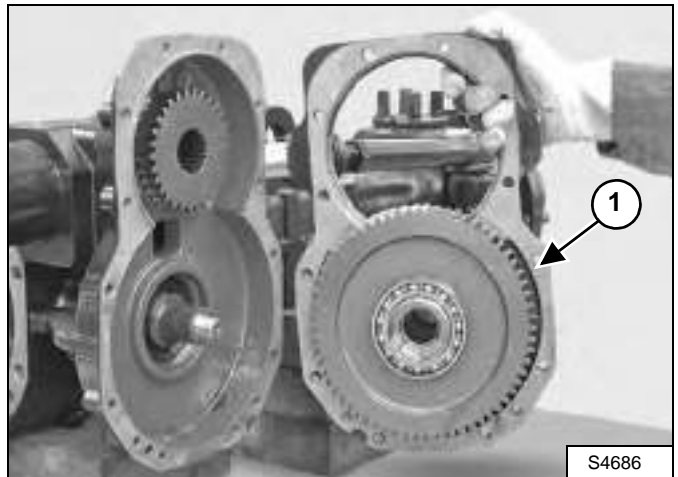

Remove the securing bolts and lift off the cover (Item 1) [Figure 20-70-5].



## DRIVE BOX(CONT'D)

### Disassembly (Cont'd)

Figure 20-70-6

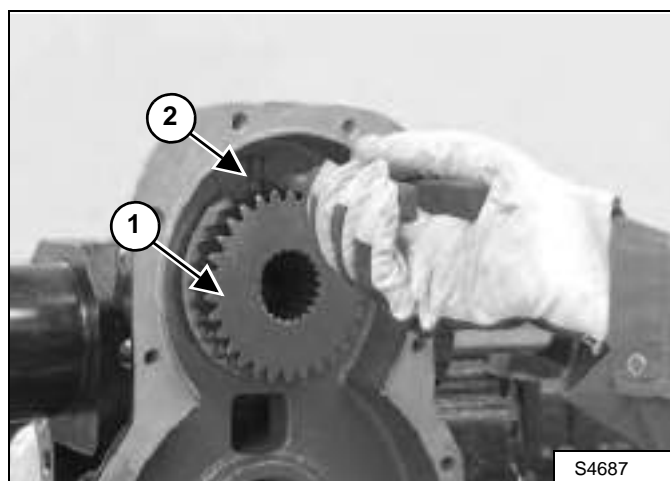

To remove the drive side shaft (Item 1), hook off the snap ring (Item 2) [Figure 20-70-6].

Figure 20-70-7

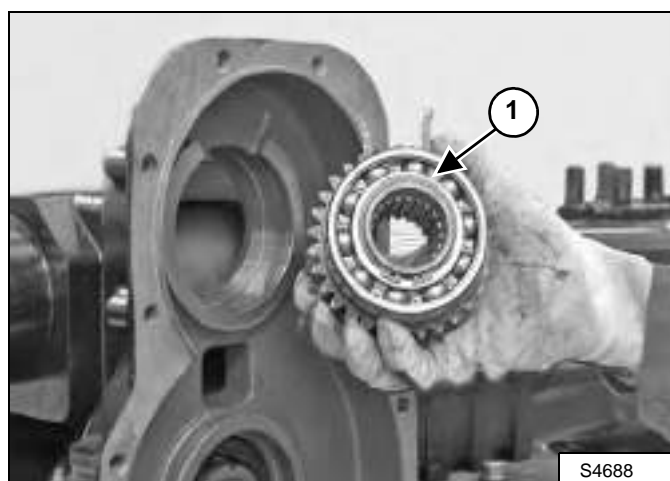

Using two levers, remove the drive side shaft (Item 1) [Figure 20-70-7].

Figure 20-70-8



Using two levers, remove the flange sealing ring (Item 1) [Figure 20-70-8].

Figure 20-70-9

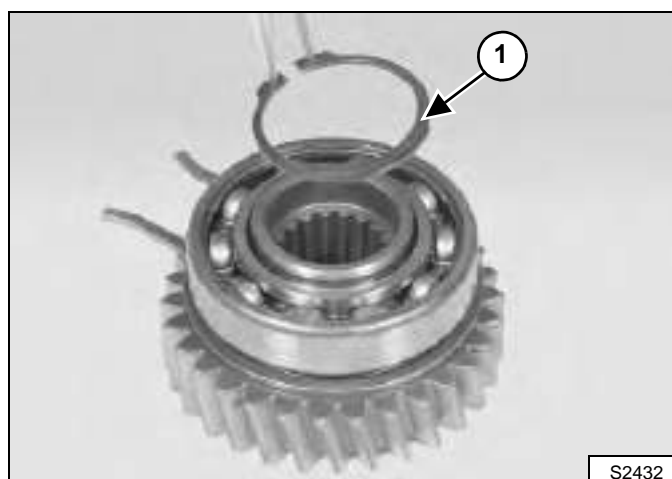

Remove the snap ring (Item 1) [Figure 20-70-9].

## DRIVE BOX(CONT'D)

### Disassembly (Cont'd)

Figure 20-70-10

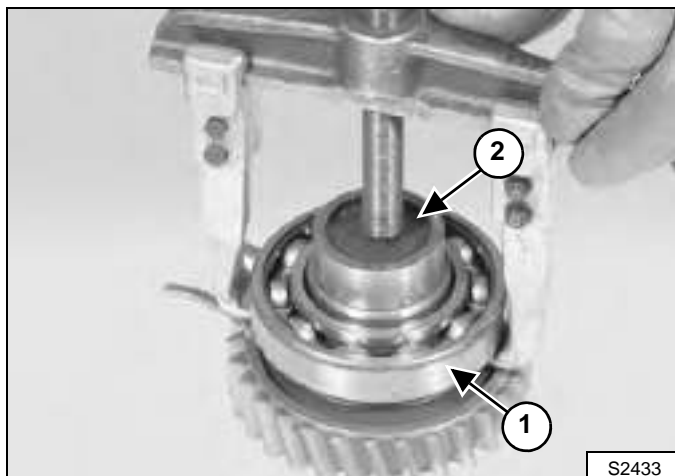

With a puller, remove the bearing (Item 1) from the input shaft (Item 2) [Figure 20-70-10].

Figure 20-70-11

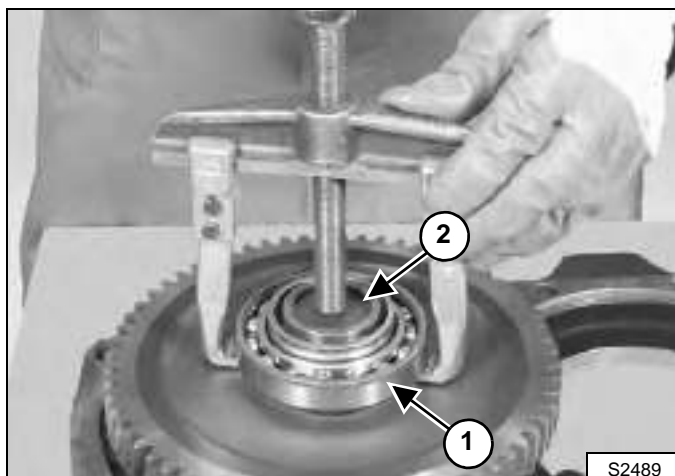

With a puller, remove the bearing (Item 1) from the flange shaft (Item 2) [Figure 20-70-11].

Figure 20-70-12

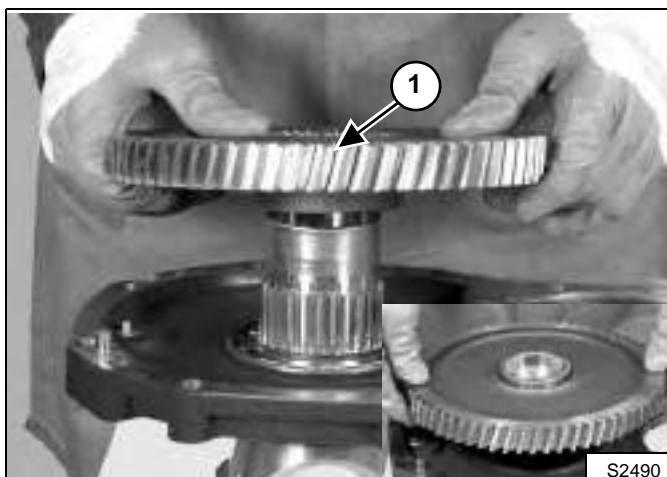

Remove the secondary gear wheel (Item 1) [Figure 20-70-12] using two levers.

Figure 20-70-13

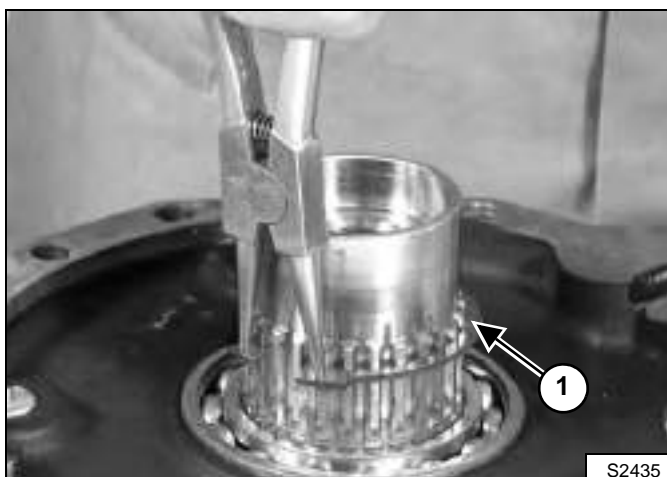

Remove the snap ring (Item 1) [Figure 20-70-13].

## DRIVE BOX(CONT'D)

### Disassembly (Cont'd)

Figure 20-70-14

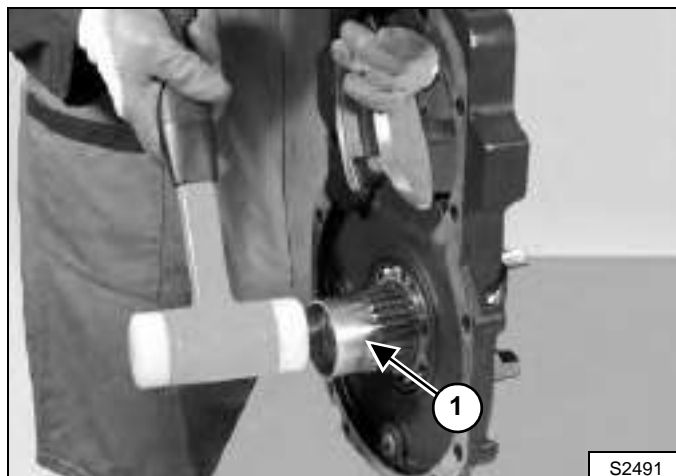

Remove the flange (Item 1) [Figure 20-70-14] by means of a plastic hammer.

Figure 20-70-15

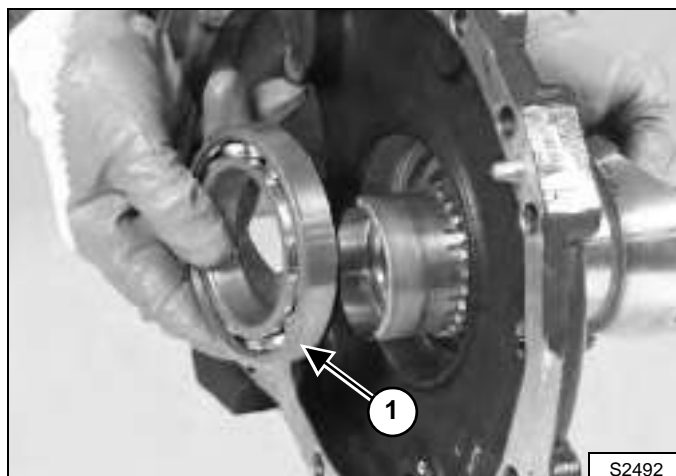

Remove the internal bearing (Item 1) [Figure 20-70-15].

Figure 20-70-16

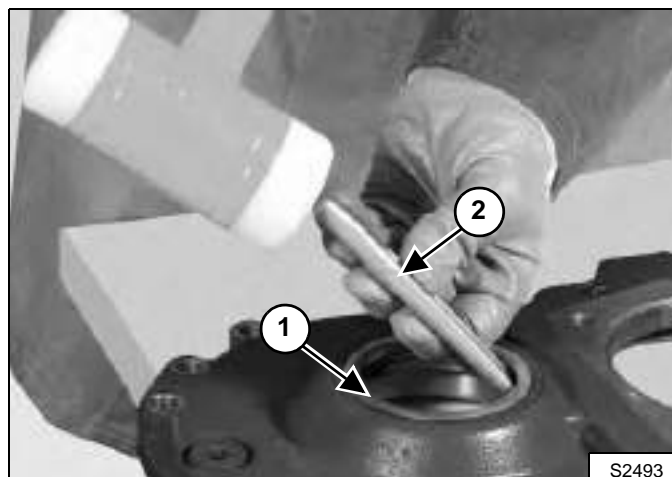

Pull out the cup of the sealing ring (Item 1) by using drift (Item 2) [Figure 20-70-16].

## DRIVE BOX(CONT'D)

### Assembly

Figure 20-70-17

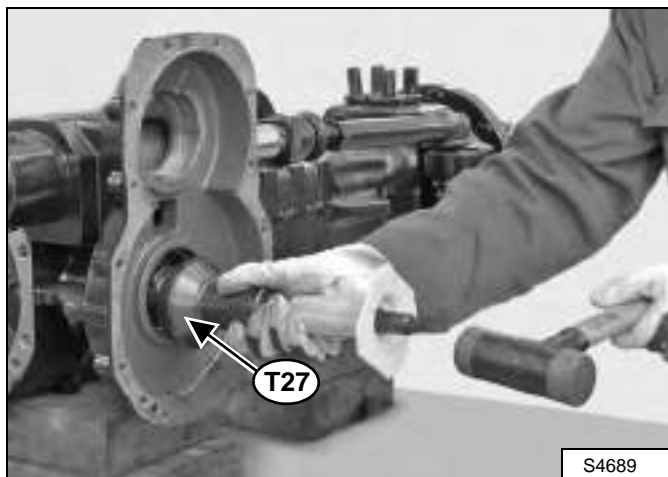

Insert the sealing ring using tool T27.

**NOTE:** Bring the sealing ring just to the end stop, apply grease to the sealing lips.

Figure 20-70-18



Insert the sealing ring (Item 1) [Figure 20-70-18] with a normal tool.

**NOTE:** Bring the sealing ring just to the end stop, apply grease to the sealing lips.

Figure 20-70-19

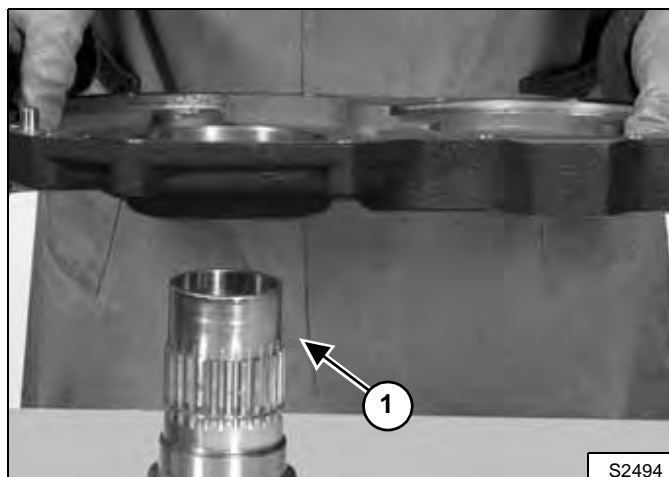

Fit the flange (Item 1) [Figure 20-70-19] and fasten it.

For keying the flange (Item 1) [Figure 20-70-19], use a plastic hammer if necessary.

Figure 20-70-20



Insert the bearing (Item 1) [Figure 20-70-20].

## DRIVE BOX(CONT'D)

### Assembly (Cont'd)

Figure 20-70-21

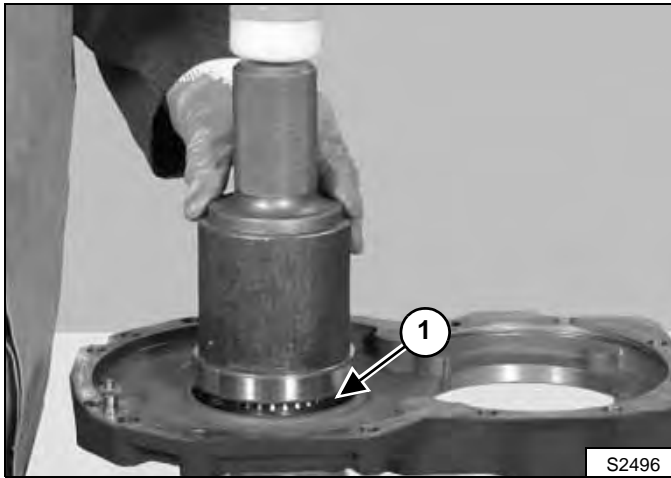

Using a normal tool insert the bearing (Item 1) [Figure 20-70-21] and snap ring.

Figure 20-70-22



Install the secondary gear wheel (Item 1) [Figure 20-70-22] with a plastic hammer.

Figure 20-70-23

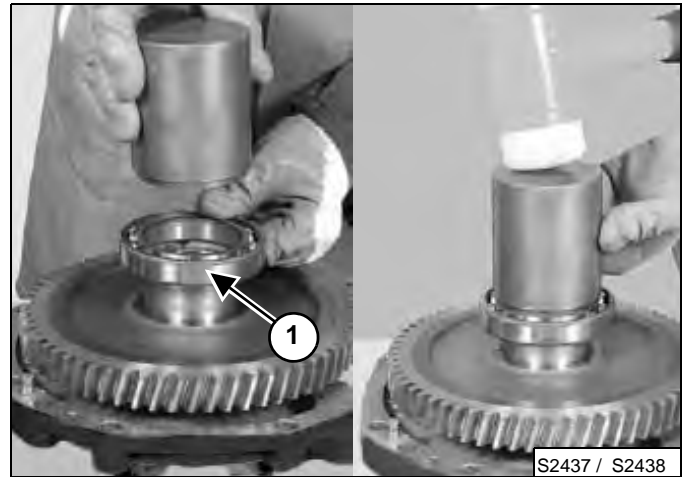

Using a normal tool insert the bearing (Item 1) [Figure 20-70-23].

Figure 20-70-24

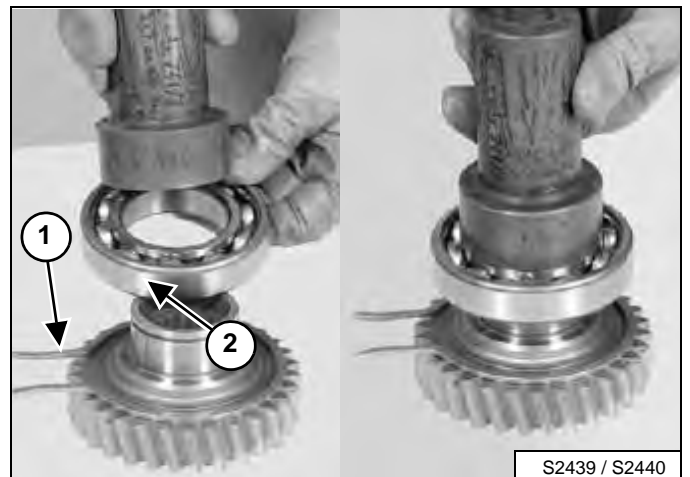

Insert the snap ring (Item 1) and using a normal tool insert the bearing (Item 2) [Figure 20-70-24].

## DRIVE BOX(CONT'D)

### Assembly (Cont'd)

Figure 20-70-25

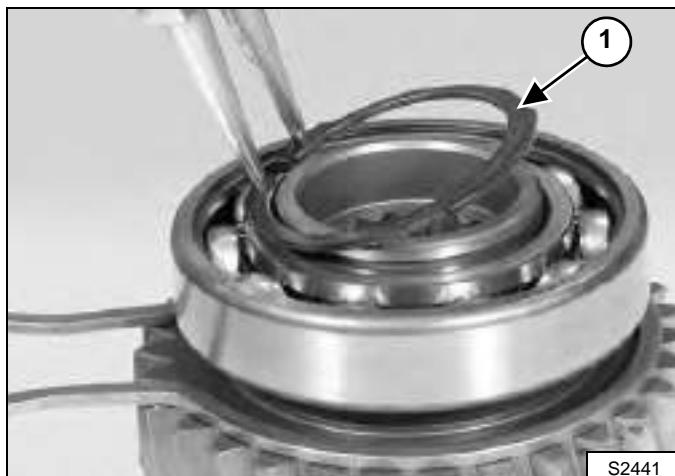

Fix the bearing with the snap ring (Item 1) [Figure 20-70-25].

Figure 20-70-26

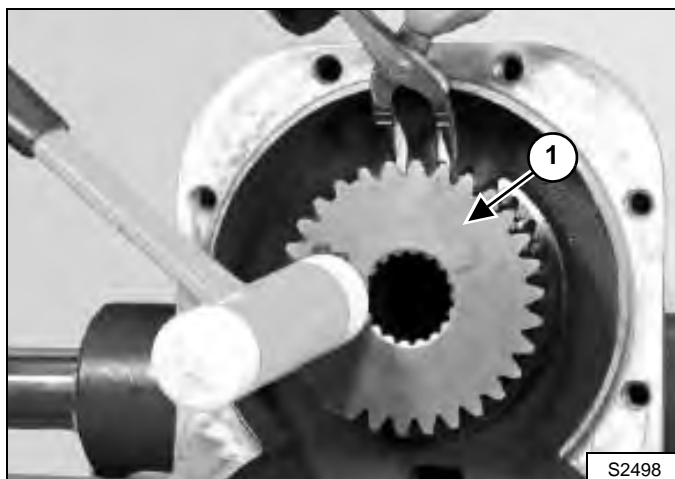

Hold the drive side shaft (Item 1) [Figure 20-70-26] using a plier and install the drive side shaft with a plastic hammer.

Figure 20-70-27

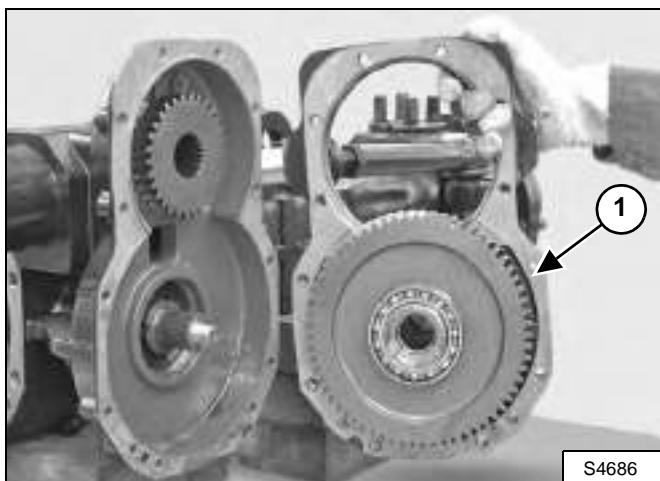

Install drive side flange cover (Item 1) [Figure 20-70-27], apply LOCTITE 510 to the short screws.

Figure 20-70-28

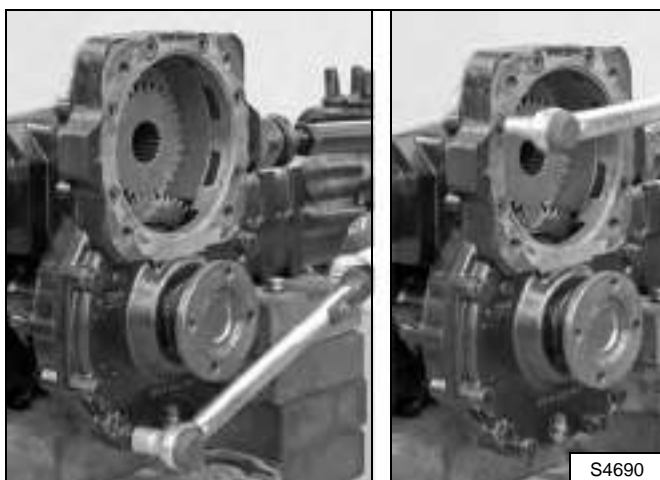

Tighten the bolts [Figure 20-70-28] of 60 - 66 ft.-lb. (80-90 N•m) torque.

---

**DRIVE BOX(CONT'D)****Special Tools**

TOOL	IMAGE	DESCRIPTION	BOBCAT PN
T27		Pinion tail seal	6912202



**Bobcat®**



## MAIN RELIEF VALVE

### Testing And Adjustment

The following tool will be needed to do the following procedure:

MEL10003-Hydraulic Tester

Figure 20-80-1

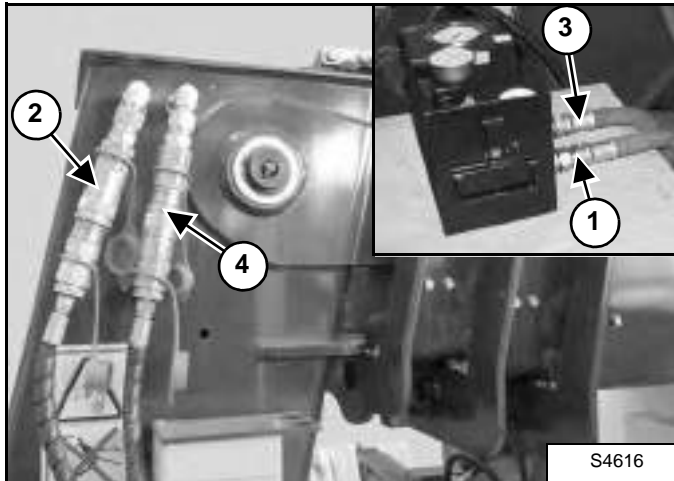

Connect the inlet hose (Item 1) from the tester to the front coupler (Item 2) [Figure 20-80-1].

Connect the outlet hose (Item 3) from the tester to the rear coupler (Item 4) [Figure 20-80-1].

## IMPORTANT

**Always keep the same size tires on the same side of the skid steer loader to avoid damage to the loader. Rotate tires according to the procedure given in the manual.**

I-2004-1285

Figure 20-80-2

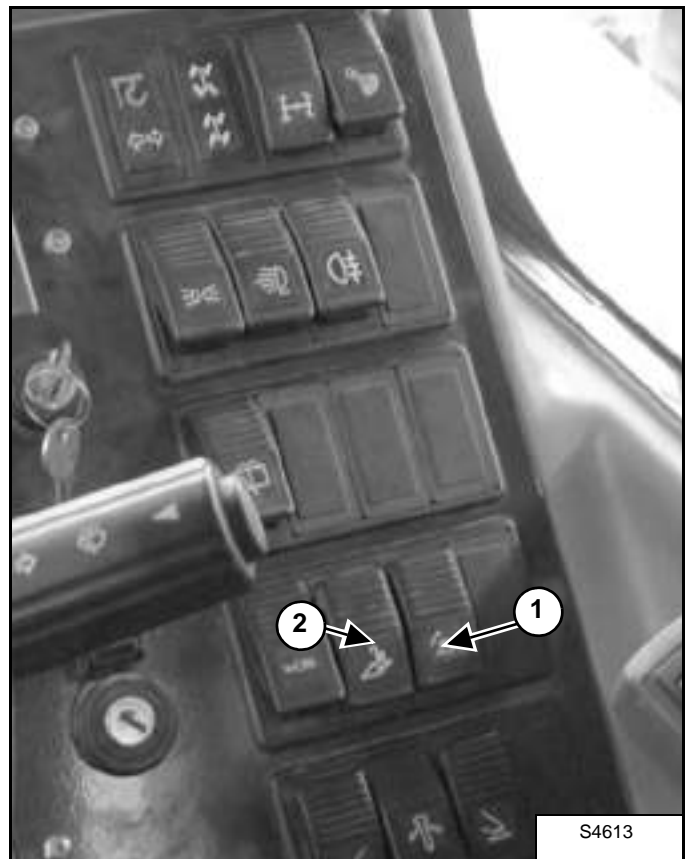

Start the engine, lower the restraint bar (if equipped) and run at low idle RPM. Push the detent rocker switch (Item 1) and front auxiliary rocker switch (Item 2) [Figure 20-80-2]. Make sure the tester is connected correctly. If no flow is indicated on the tester, the hoses are connected wrong. With the hoses connected correctly, increase the engine speed to 2200 RPM.

Warm the fluid to 140 °F (60 °C) by turning the restrictor control on the tester to about 1000 psi (69 Bar). DO NOT exceed system relief pressure. Open the restrictor control knob and record the free flow (GPM) at 2200 RPM.

There should be 13 GPM (55 L/min) free flow. Turn the restrictor control on the tester until the main relief opens. The correct pressure should be 3700 PSI (255 Bar).

If adjustment is needed, (See [Figure 20-80-4].)

## MAIN RELIEF VALVE (CONT'D)

### Testing And Adjustment (Cont'd)

Remove the rear cover.

Figure 20-80-3

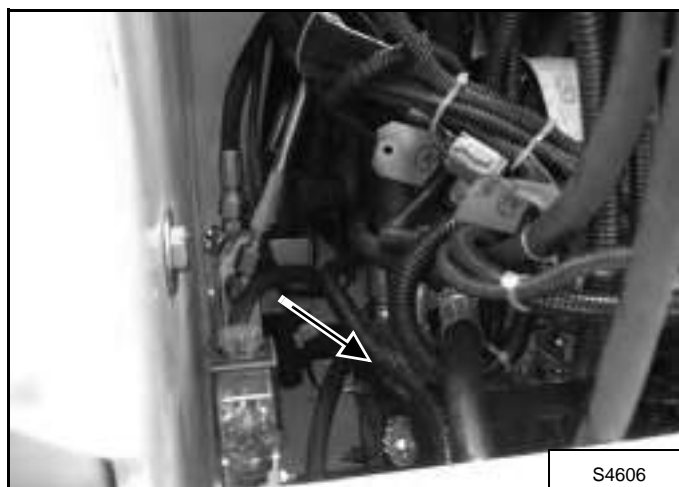

Locate the main relief valve on the upper left side of the control valve [Figure 20-80-3].

Figure 20-80-4

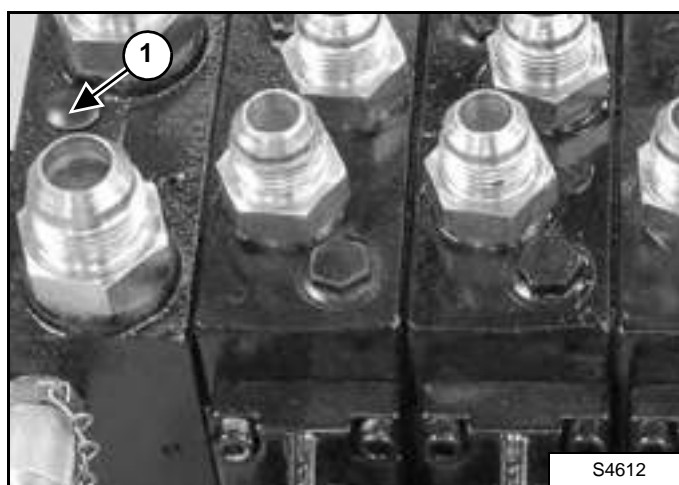

Take off the plastic plug (Item 1) [Figure 20-80-4] and turn the adjustment screw clockwise to increase the pressure or counterclockwise to decrease the pressure.

**NOTE: One full turn = 1500 psi (100 Bar).**

Retest the main relief valve after adjustment.

## Removal and Installation

# IMPORTANT

When repairing hydrostatic and hydraulic systems, clean the work area before disassembly and keep all parts clean. Always use caps and plugs on hoses, tubelines and ports to keep dirt out. Dirt can quickly damage the system.

I-2003-0888

Figure 20-80-5

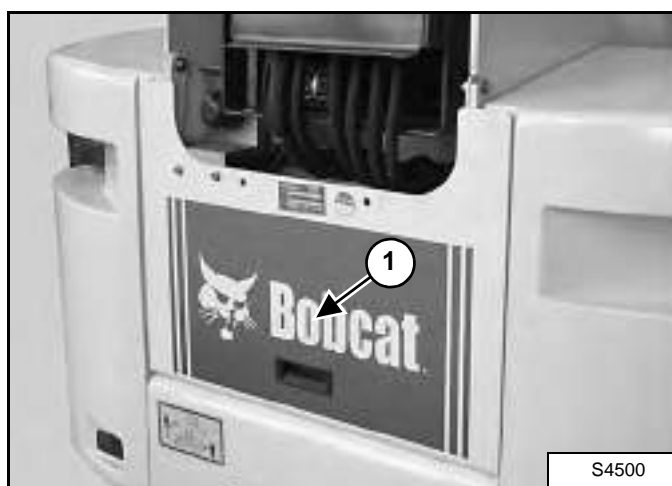

Remove the rear cover (Item 1) [Figure 20-80-5].

Locate the main relief valve on the upper left side of the control valve.

Clean the area around the control valve.

## MAIN RELIEF VALVE (CONT'D)

### Removal And Installation (Cont'd)

Figure 20-80-6

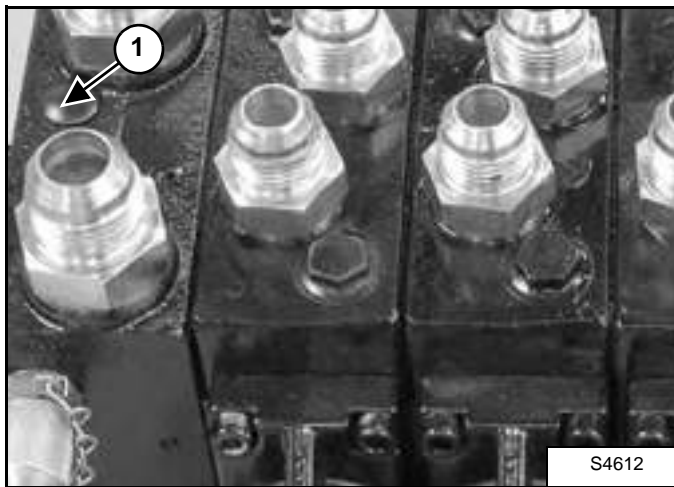

Remove the plastic plug (Item 1) [Figure 20-80-6].

Figure 20-80-7

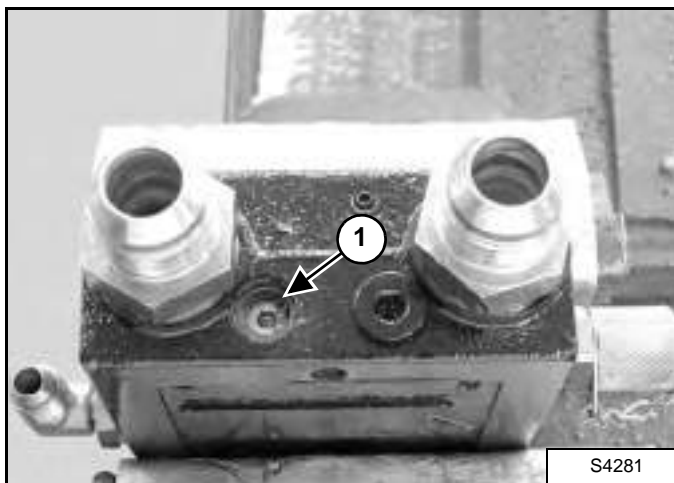

Remove the snap ring (Item 1) [Figure 20-80-7].

Figure 20-80-8

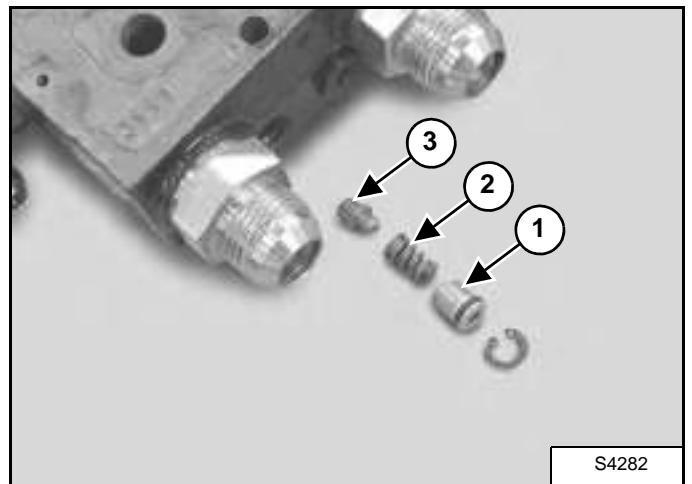

Remove the main relief valve plug (Item 1), the spring (Item 2) and the pin (Item 3) [Figure 20-80-8] out of the valve block.

**Installation:** Tighten the main relief valve plug to 33 ft.-lb. (45 N•m) torque.



**Bobcat®**

## QUICK TACH CYLINDER

### Removal And Installation

Figure 20-90-1

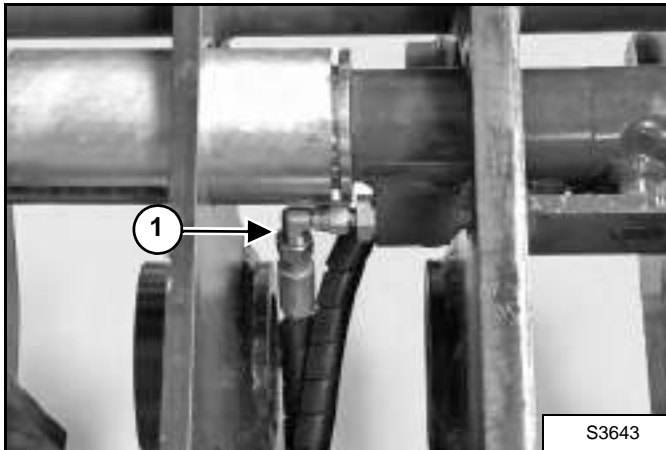

Remove the two hoses (Item 1) [Figure 20-90-1] from the cylinder.

**NOTE:** Mark the hoses for correct installation.

# IMPORTANT

When repairing hydrostatic and hydraulic systems, clean the work area before disassembly and keep all parts clean. Always use caps and plugs on hoses, tubelines and ports to keep dirt out. Dirt can quickly damage the system.

I-2003-0888

Figure 20-90-2

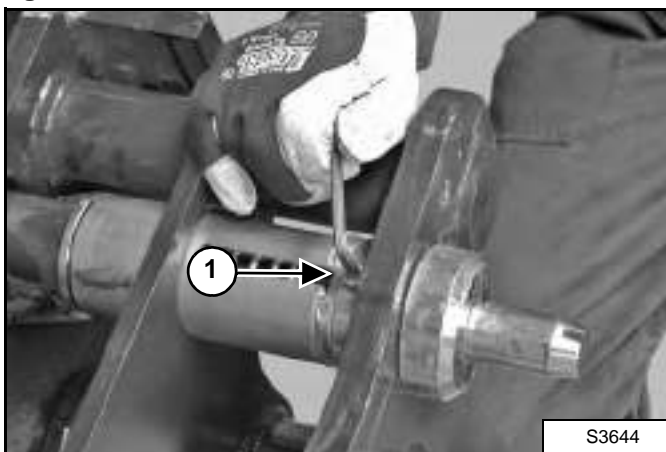

Remove the bolt (Item 1) [Figure 20-90-2] from each side of the cylinder.

Figure 20-90-3

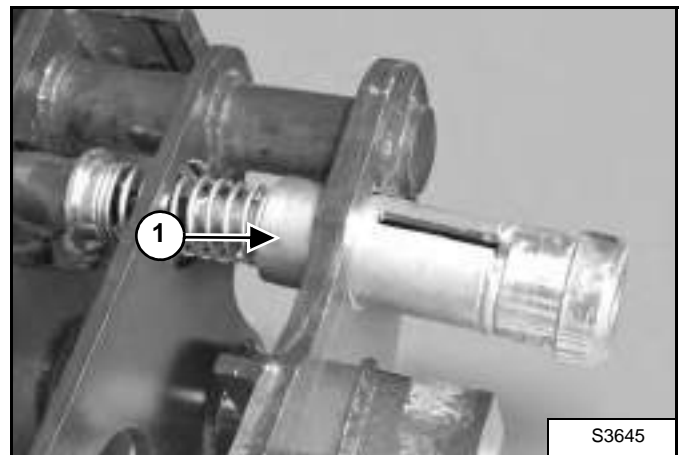

Remove the end bushing (Item 1) [Figure 20-90-3].

Figure 20-90-4

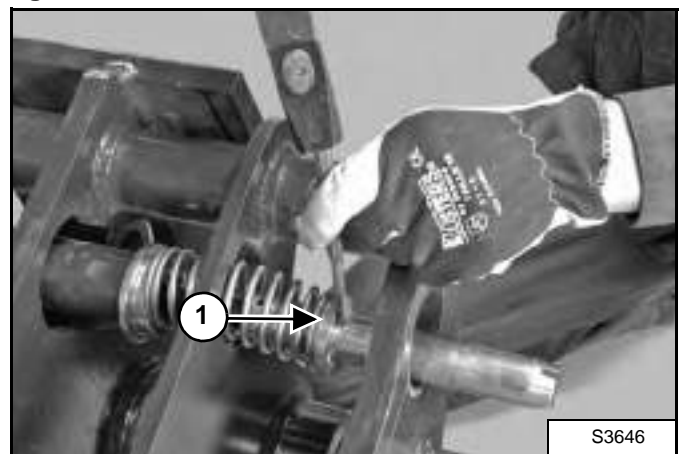

Remove the roll pin (Item 1) [Figure 20-90-4].

## QUICK TACH CYLINDER (CONT'D)

### Removal And Installation (Cont'd)

Figure 20-90-5

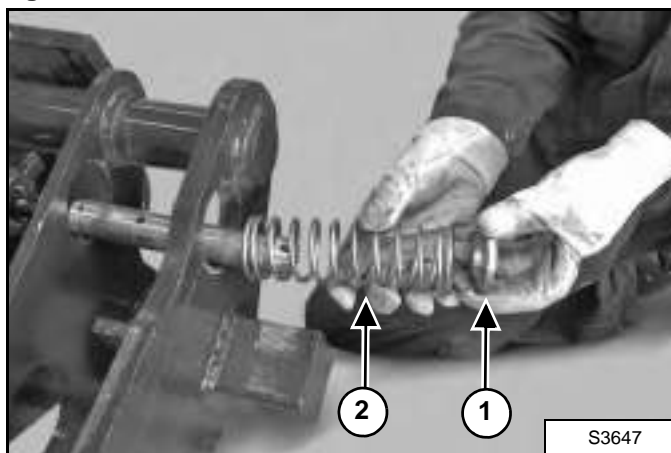

Remove the washer (Item 1) and spring (Item 2) [Figure 20-90-5] from the cylinder rod extension.

Figure 20-90-6

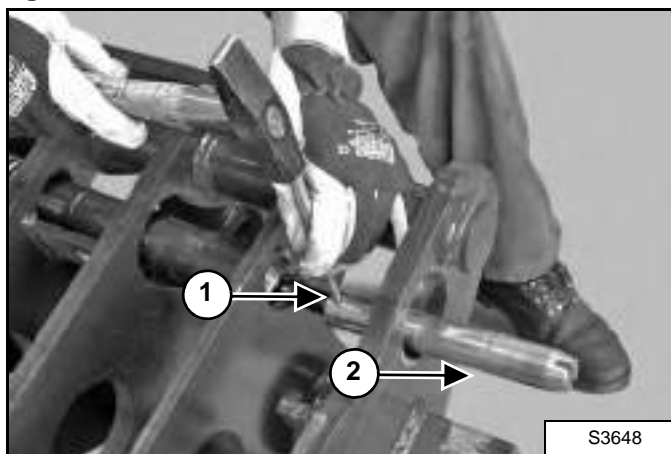

Remove the roll pin (Item 1) and remove the extension rod (Item 2) [Figure 20-90-6] from the cylinder rod.

Figure 20-90-7

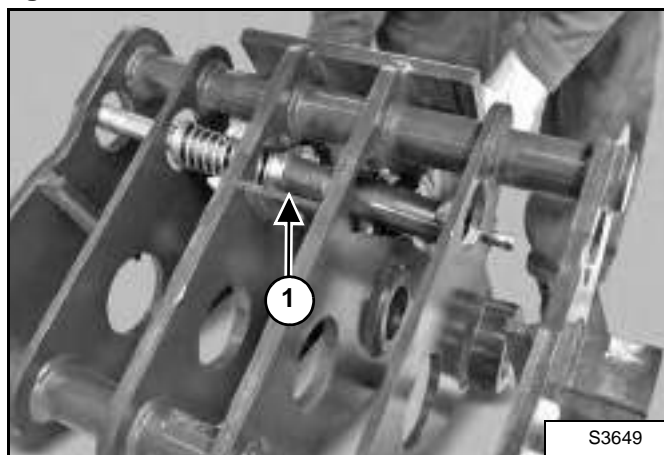

Remove the cylinder (Item 1) [Figure 20-90-7].

## QUICK TACH CYLINDER (CONT'D)

### Parts Identification

1. Quick tach cylinder
2. Cylinder
3. Spindle
4. Nut
5. Seal kit

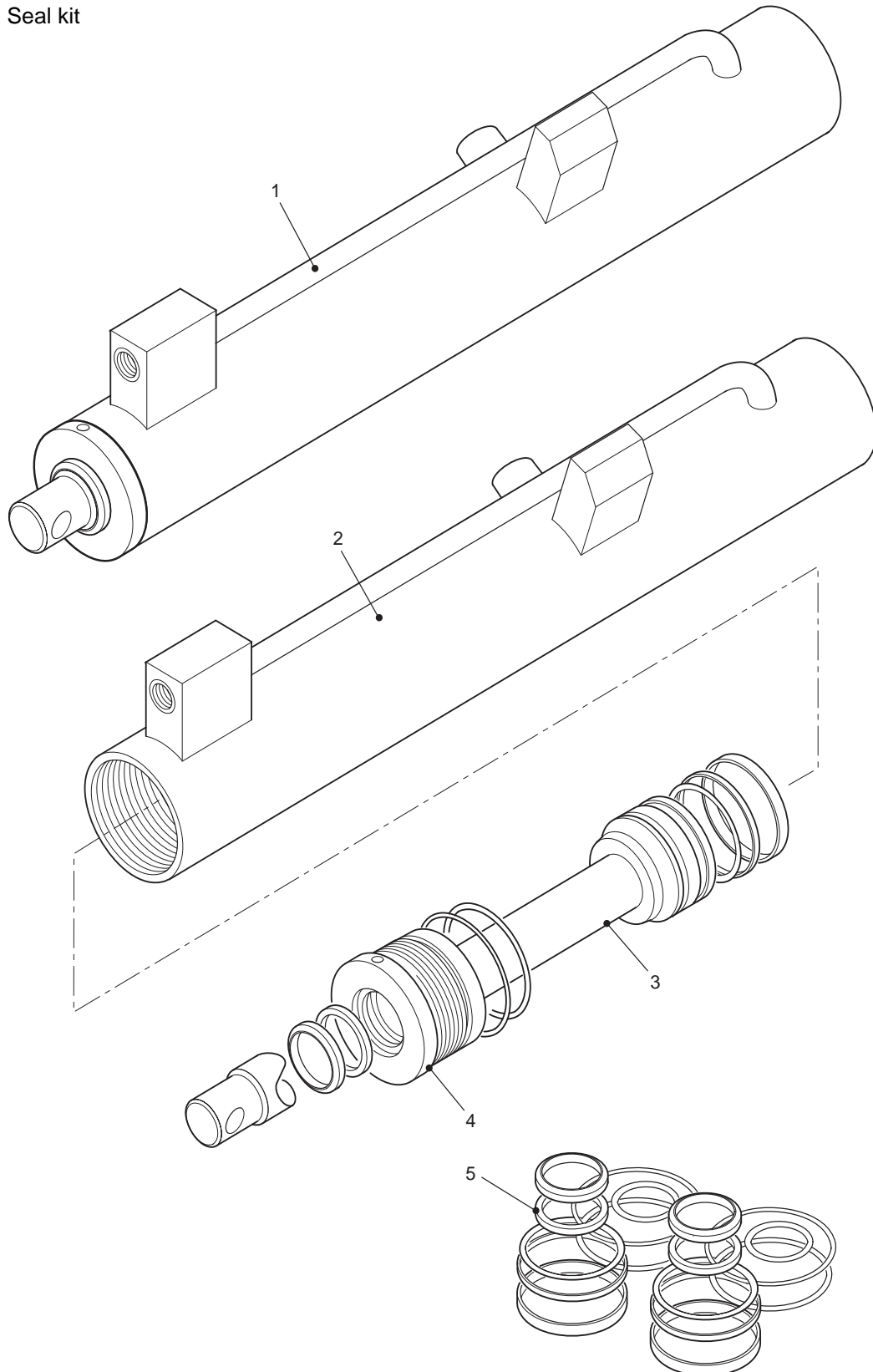

S4706

## QUICK TACH CYLINDER (CONT'D)

### Disassembly

Use the following tool to disassemble the cylinder:

MEL1076-Cylinder Wrench

**Figure 20-90-8**



Place the cylinder in a vise [Figure 20-90-8].

**Figure 20-90-9**

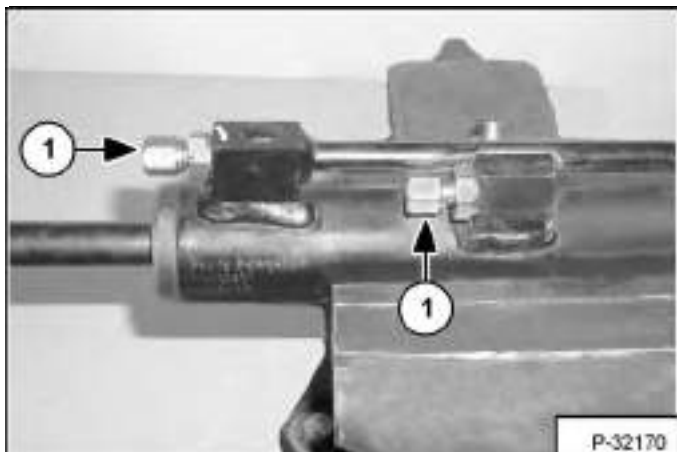

Remove the two fittings (Item 1) [Figure 20-90-9].

**Figure 20-90-10**

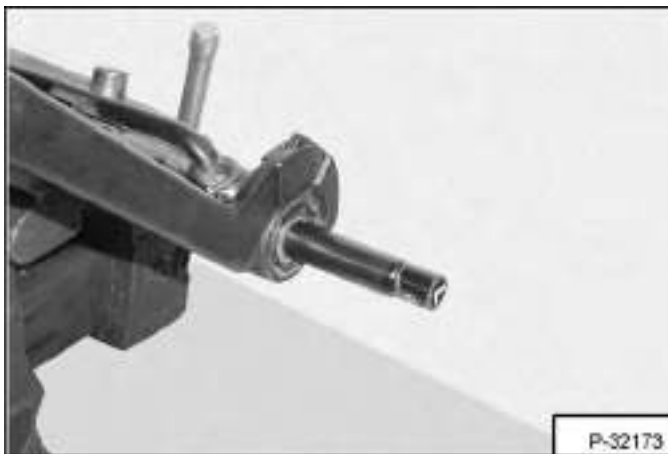

Use the cylinder wrench to loosen the head gland [Figure 20-90-10].

### Assembly

Use the following tool to assemble the cylinder:

MEL1076-Cylinder Wrench

Wash the cylinder parts in solvent and dry with compressed air.

Inspect the cylinder parts for nicks, scratches or other damage. Replace any damaged parts.

Lubricate all O-rings and seals with hydraulic oil during installation.

Always use new O-rings and seals.



## FRAME LEVELING CYLINDER

### Removal And Installation

Remove the front weight from the machine.

# ! WARNING

Hydraulic fluid escaping under pressure can have sufficient force to enter a person's body by penetrating the skin. This can cause serious injury and possible death if proper medical treatment by a physician familiar with this injury is not received immediately.

W-2145-0290

# IMPORTANT

When repairing hydrostatic and hydraulic systems, clean the work area before disassembly and keep all parts clean. Always use caps and plugs on hoses, tubelines and ports to keep dirt out. Dirt can quickly damage the system.

I-2003-0888

**NOTE:** Mark all hoses for correct installation.

Figure 20-100-1

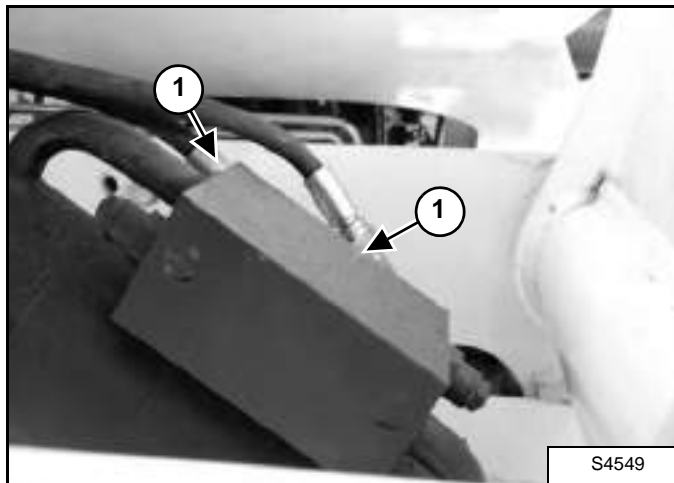

Remove the two hoses (Item 1) [Figure 20-100-1].

Install caps and plugs.

Figure 20-100-2



Support the frame leveling cylinder with a bar as shown in [Figure 20-100-2].

Figure 20-100-3

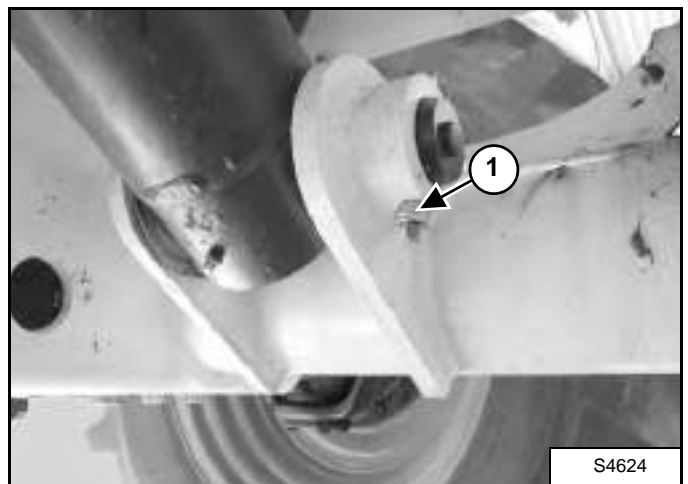

Remove the bolt and nut (Item 1) [Figure 20-100-3] from the lower pivot pin.

## FRAME LEVELLING CYLINDER (CONT'D)

### Removal And Installation (Cont'd)

Figure 20-100-4

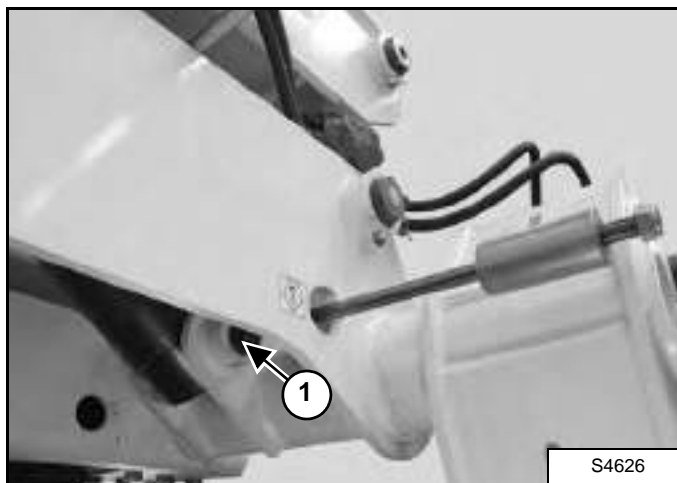

Remove the lower pivot pin (Item 1) [Figure 20-100-4] from the machine.

Figure 20-100-5



Remove the bolt and nut (Item 1) [Figure 20-100-5] from the pivot pin.

**NOTE: Make sure the frame leveling cylinder is supported well.**

Figure 20-100-6

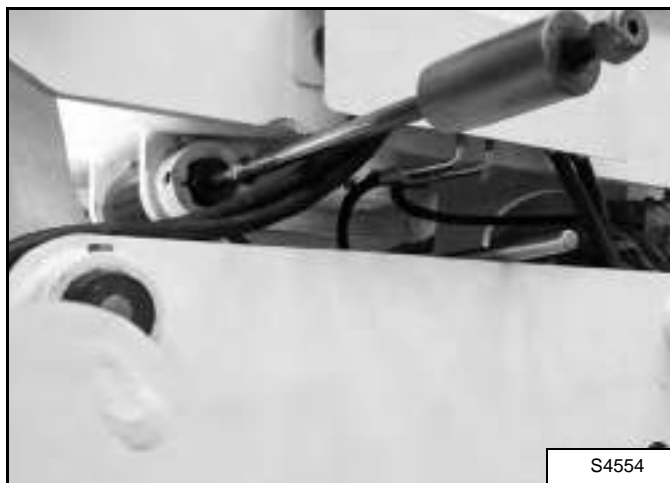

Remove the pivot pin as shown in [Figure 20-100-6].

Carefully remove the bar and lower the frame leveling cylinder.

Remove the frame leveling cylinder.

## FRAME LEVELING CYLINDER (CONT'D)

### Parts Identification

1. Relief Cartridge
2. Housing
3. Wear Ring
4. Seal
5. Set Screw
6. Piston
7. O-ring
8. Sleeve
9. Head Gland
10. Wiper
11. Bushing
12. Rod
13. Grease Fitting

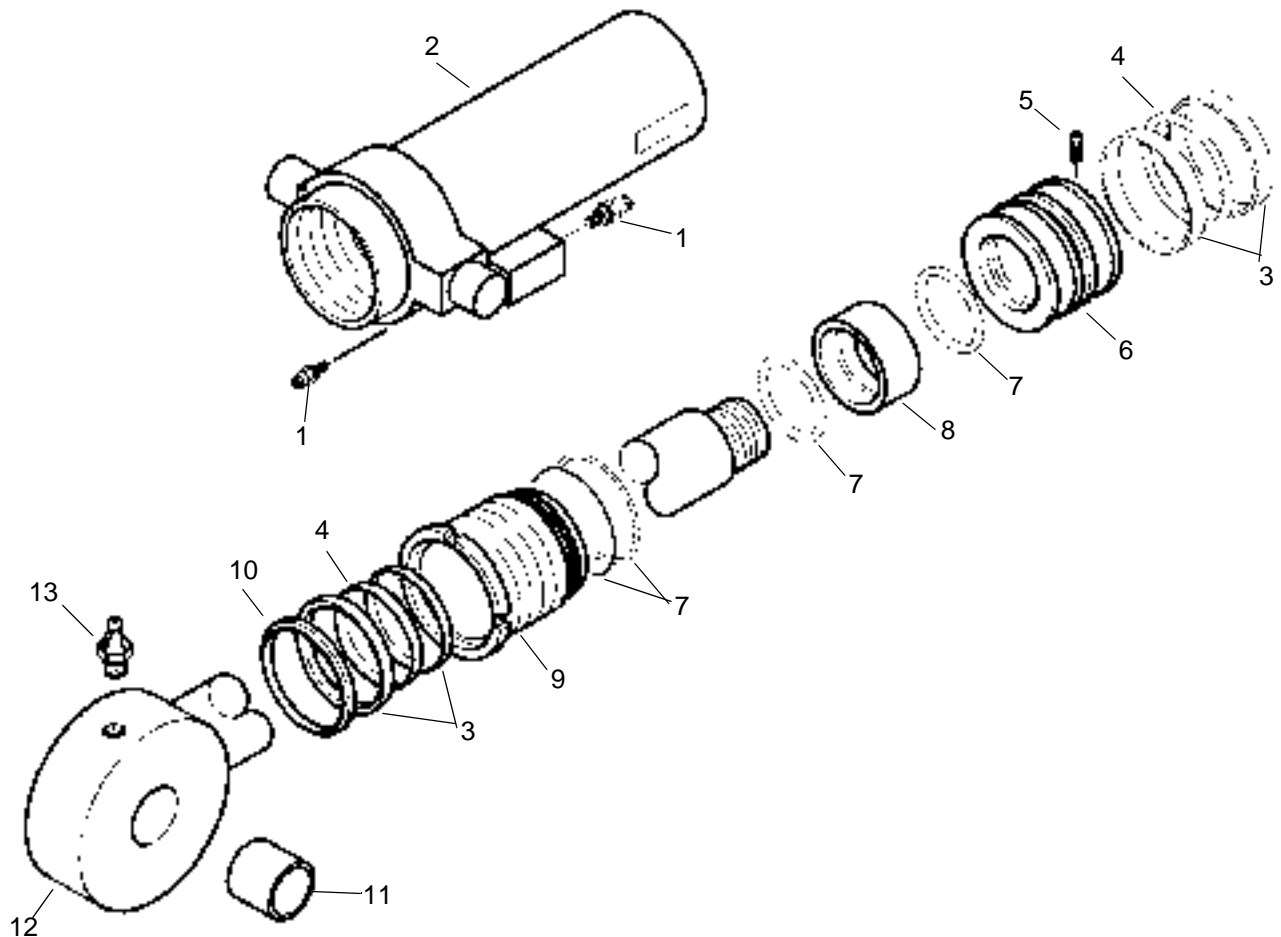

b-19814

## FRAME LEVELING CYLINDER (CONT'D)

### Disassembly

Use the following tools to disassemble the cylinder:

MEL1353 - Cylinder Gland Nut Wrench

**Figure 20-100-7**

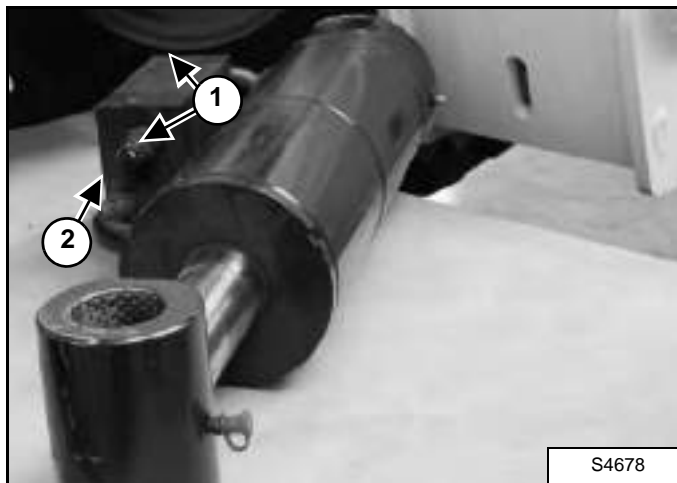

Remove the two relief cartridges (Item 1) and two fittings (Item 2) [Figure 20-100-7].

Put the cylinder in a vise.

**Figure 20-100-8**

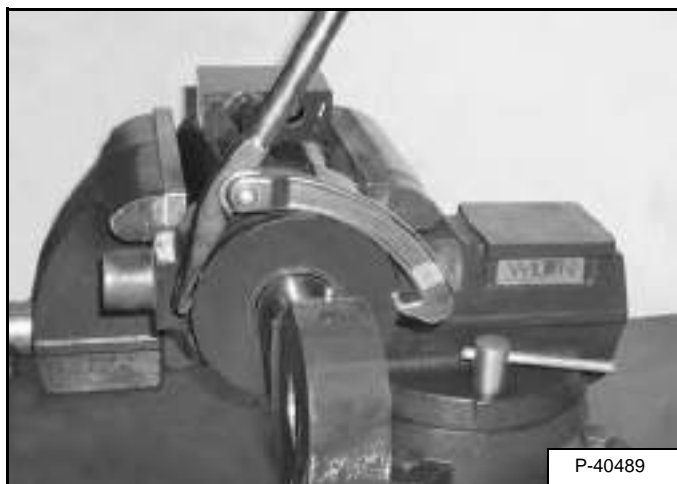

Remove the cylinder head gland with a cylinder gland nut wrench as shown in [Figure 20-100-8].

Disassemble the frame leveling cylinder.

### Assembly

Use the following tools to assemble the cylinder (See "Parts Identification" on page 20-100-3):

MEL1353 - Cylinder Gland Nut Wrench

Wash the cylinder parts in solvent and dry with compressed air.

Inspect the cylinder parts for nicks, scratches or other damage. Replace any damaged parts.

Always use new O-rings and seals. Lubricate all O-rings and seals with hydraulic oil during installation.

Clean the threads and apply LOCTITE 242 or equivalent to the threads on the rod (Item 12) (See "Parts Identification" on page 20-100-3).

Apply LOCTITE 242 or equivalent to the set screw (Item 5) (See "Parts Identification" on page 20-100-3).

## STEERING MODE VALVE BLOCK

### Removal And Installation

# ! WARNING

Hydraulic fluid escaping under pressure can have sufficient force to enter a person's body by penetrating the skin. This can cause serious injury and possible death if proper medical treatment by a physician familiar with this injury is not received immediately.

W-2145-0290

Figure 20-110-1

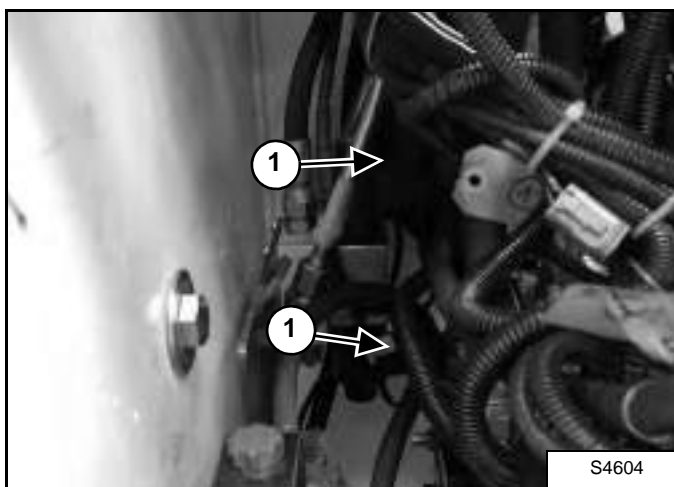

Relieve hydraulic pressure.

Remove the retainer screw (Item 1) [Figure 20-110-1] from the two solenoids.

Remove the wire connectors from the two solenoids.

**NOTE:** Mark the location of the wire connectors for correct installation.

Figure 20-110-2

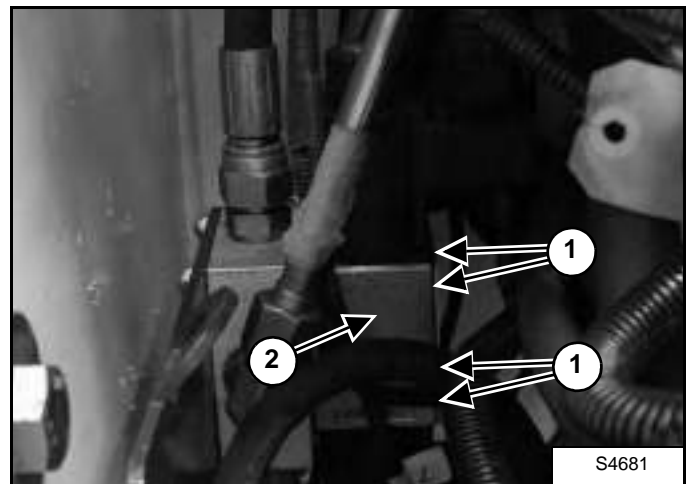

Remove the four mounting bolts (Item 1) [Figure 20-110-2].

**NOTE:** Mark the location of the valve on the block.

Remove the valve (Item 2) [Figure 20-110-2] from the block.

# IMPORTANT

When repairing hydrostatic and hydraulic systems, clean the work area before disassembly and keep all parts clean. Always use caps and plugs on hoses, tubelines and ports to keep dirt out. Dirt can quickly damage the system.

I-2003-0888

## STEERING MODE VALVE BLOCK (CONT'D)

### Removal And Installation (Cont'd)

Figure 20-110-3

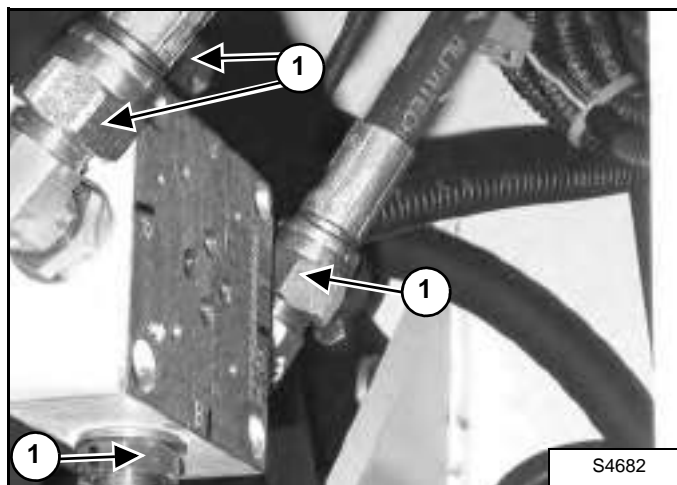

Remove the four hoses (Item 1) [Figure 20-110-3].

**NOTE:** Mark the location of the hoses.

Figure 20-110-4

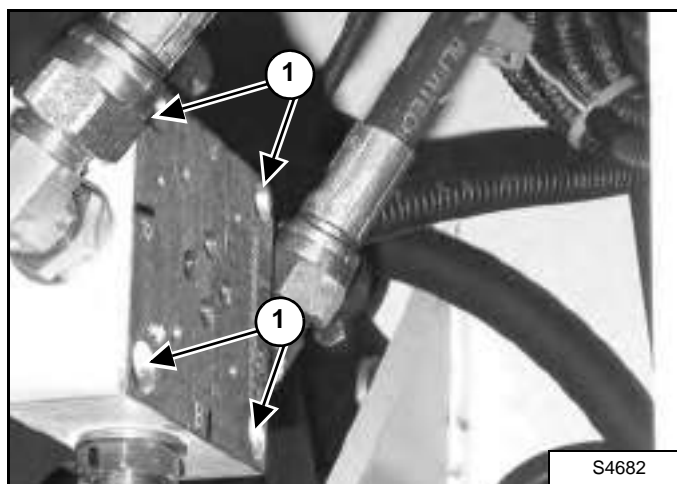

Remove the four mounting bolts (Item 1) [Figure 20-110-4] and remove the block.

## STEERING MODE VALVE BLOCK (CONT'D)

### Parts Identification

1. Nut
2. O-Ring
3. Solenoid
4. Shaft
5. Pin
6. Spring
7. Retainer
8. Spool
9. Housing
10. Bolt
11. Washer
12. Elbow
13. Adapter
14. Housing

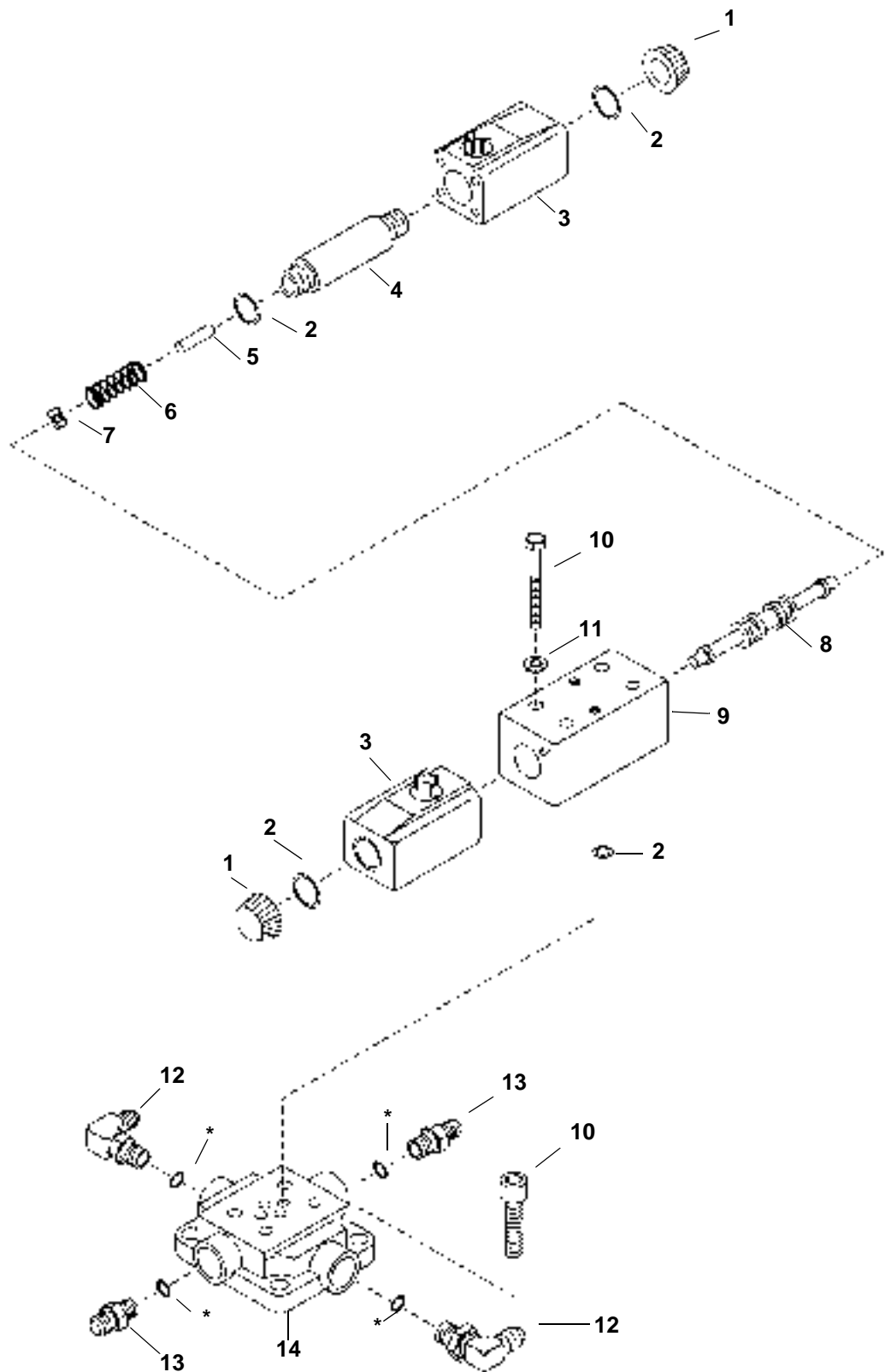

\* Supplied with fitting.

MS1152

## STEERING MODE VALVE BLOCK (CONT'D)

### Disassembly

Mark the location of the solenoids to the housing for correct assembly.

Figure 20-110-5

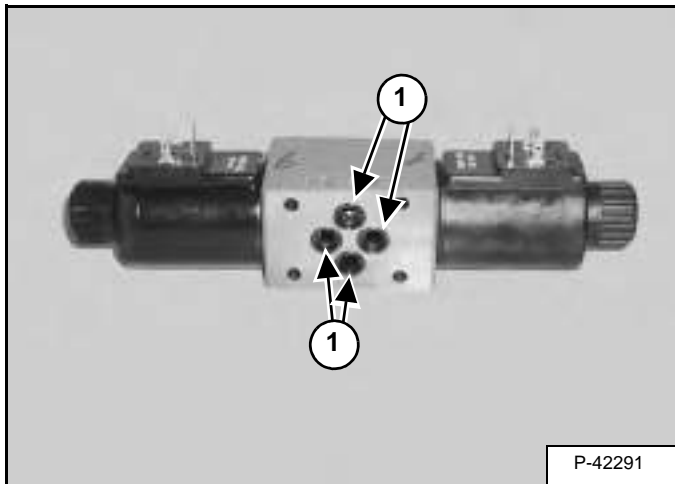

Remove the four O-rings (Item 1) [Figure 20-110-5] from the housing.

Figure 20-110-6

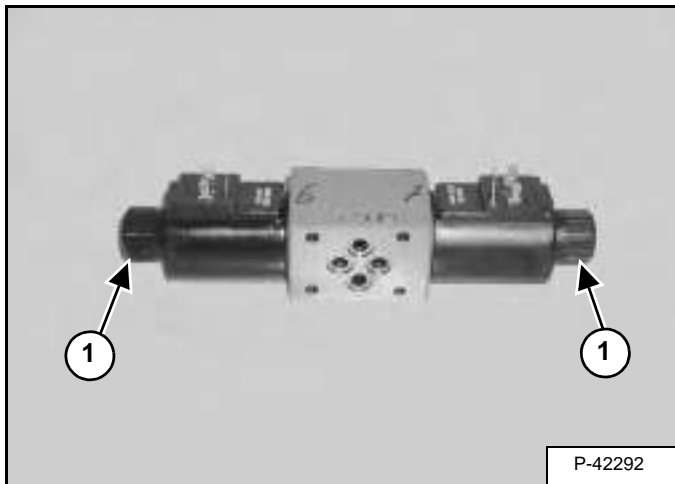

Remove the nut (Item 1) [Figure 20-110-6] from each solenoid.

**NOTE:** Mark the location of the solenoids.

# IMPORTANT

When repairing hydrostatic and hydraulic systems, clean the work area before disassembly and keep all parts clean. Always use caps and plugs on hoses, tubelines and ports to keep dirt out. Dirt can quickly damage the system.

I-2003-0888

Figure 20-110-7

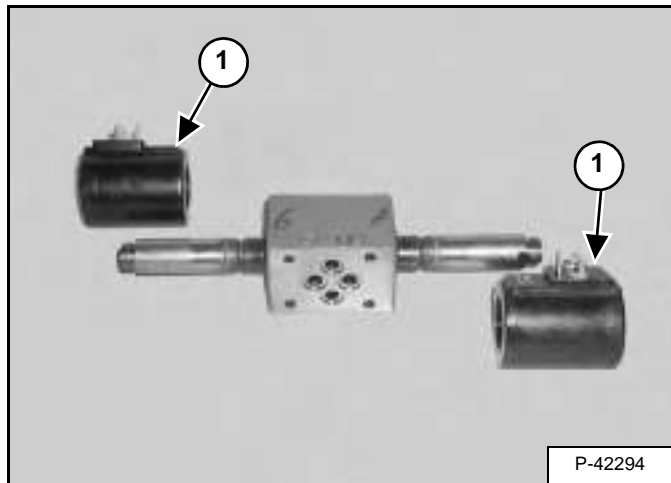

Remove the solenoids (Item 1) [Figure 20-110-7] from the solenoid shafts.

Figure 20-110-8

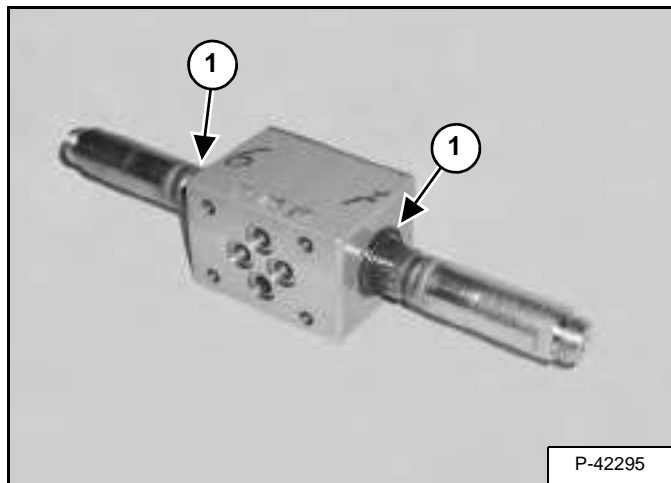

Remove the O-ring (Item 1) [Figure 20-110-8] from both shafts.



## STEERING MODE VALVE BLOCK (CONT'D)

### Disassembly (Cont'd)

Figure 20-110-9

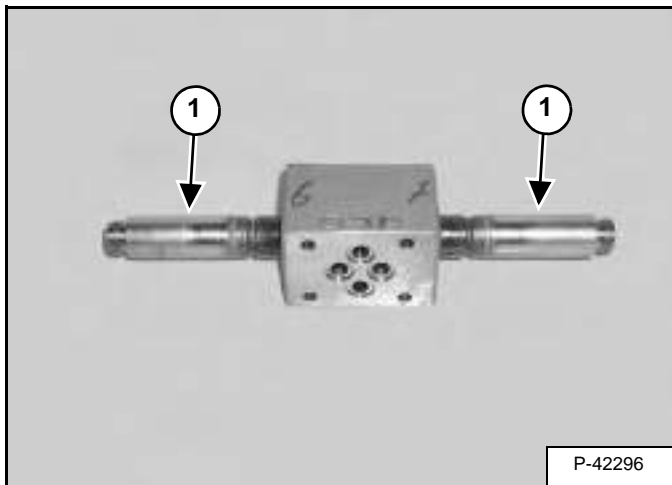

Loosen the shafts (Item 1) [Figure 20-110-9].

Figure 20-110-10

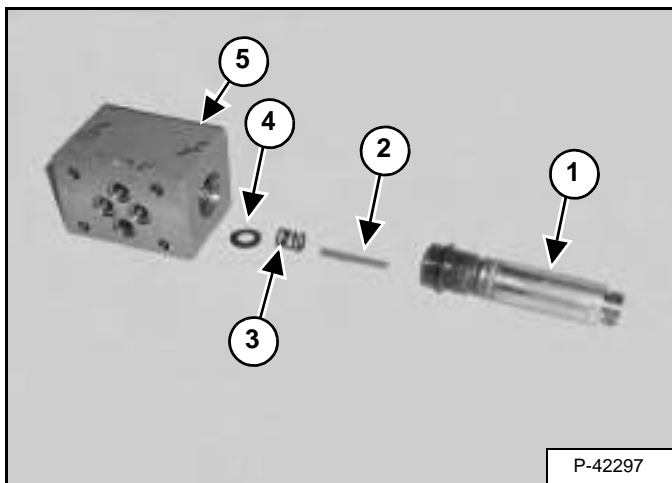

Remove the shaft (Item 1), pin (Item 2), spring (Item 3) and spring retainer (Item 4) from the housing (Item 5) [Figure 20-110-10]. (Both Sides)

Figure 20-110-11

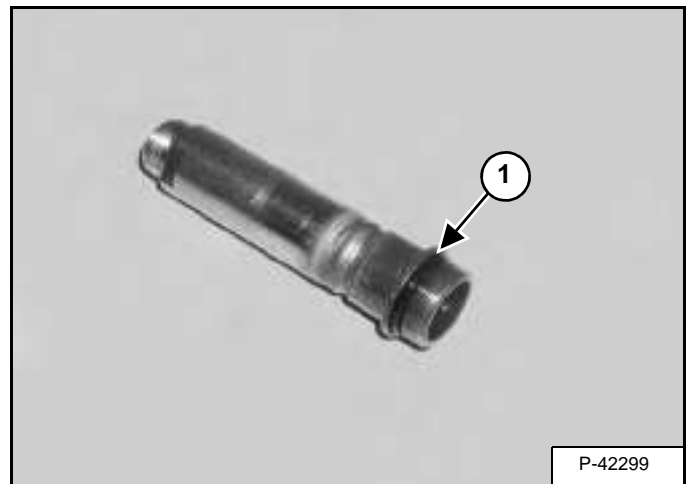

Remove the O-ring (Item 1) [Figure 20-110-11] from each shaft.

Figure 20-110-12

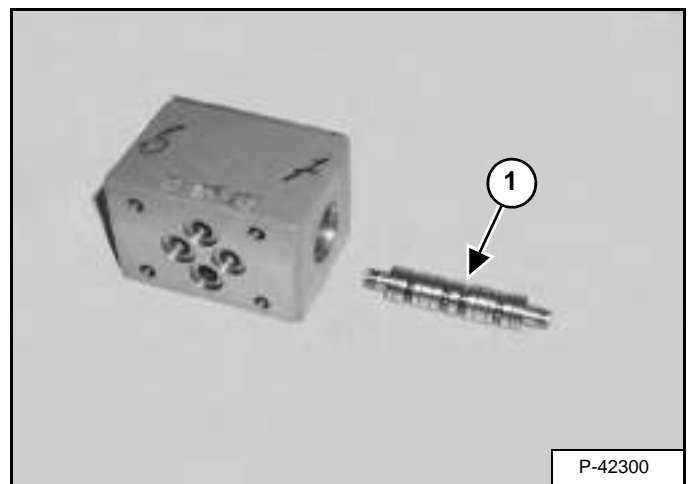

Carefully remove the spool (Item 1) [Figure 20-110-12] from the housing.

## STEERING MODE VALVE BLOCK (CONT'D)

### Solenoid Testing

Figure 20-110-13



Use a circuit tester, touch one probe to the prong and the other probe to the other prong [Figure 20-110-13], there must be continuity. If there is no continuity, replace the solenoid.

### Assembly

Clean all components with solvent and dry with compressed air.

Check all components for wear or damage. Replace any worn or damaged components.

Always use new O-rings.

Lightly oil all parts.

Figure 20-110-14

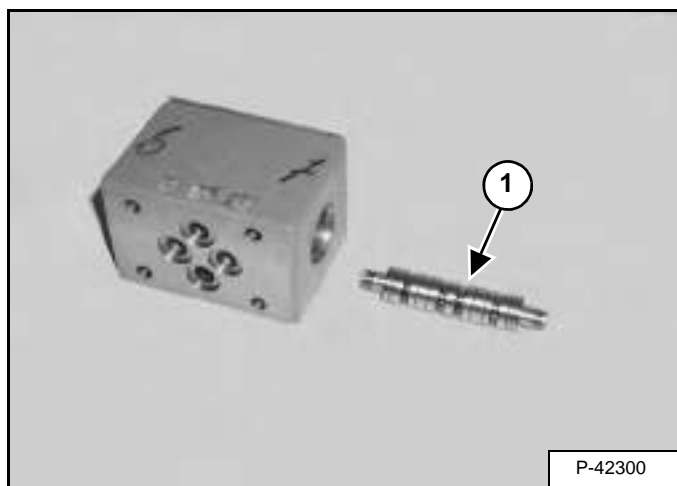

Carefully install the spool (Item 1) [Figure 20-110-14].

Figure 20-110-15

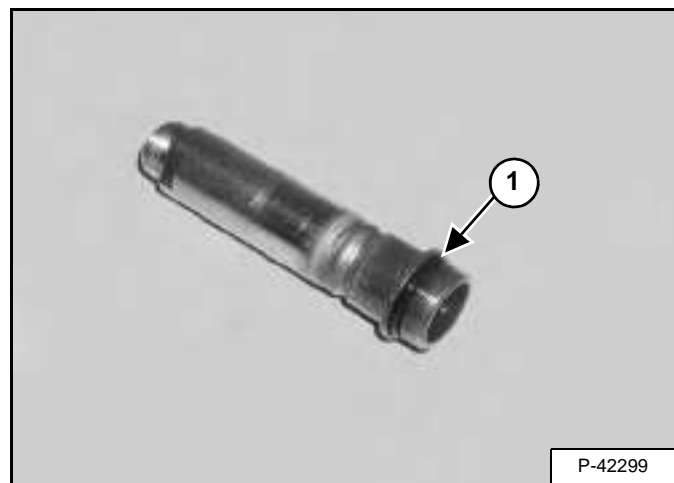

Install a new O-ring (Item 1) [Figure 20-110-15] on each shaft.

Figure 20-110-16

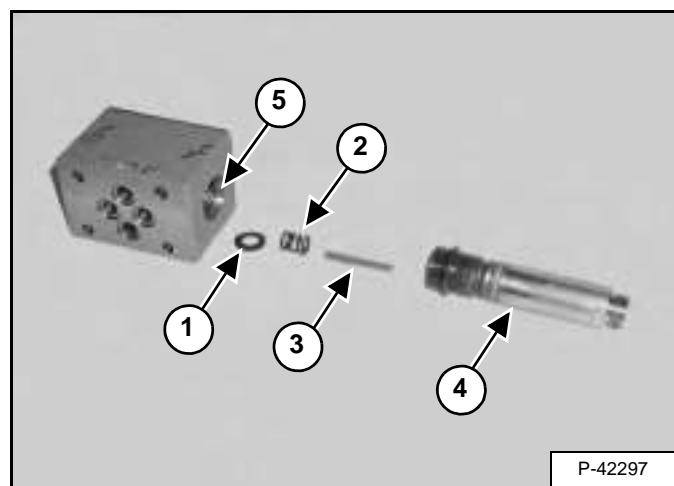

Install the spring retainer (Item 1), spring (Item 2), pin (Item 3) and shaft (Item 4) in the housing (Item 5) [Figure 20-110-16]. (Both Sides)

## STEERING MODE VALVE BLOCK (CONT'D)

### Assembly (Cont'd)

Figure 20-110-17

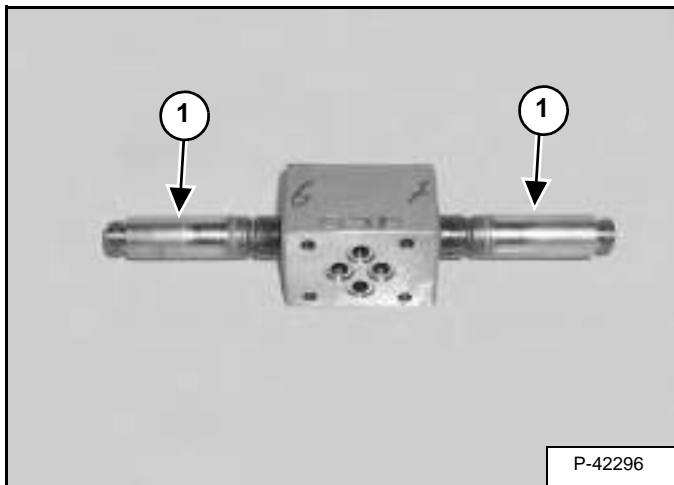

Tighten each shaft (Item 1) [Figure 20-110-17].

Figure 20-110-18

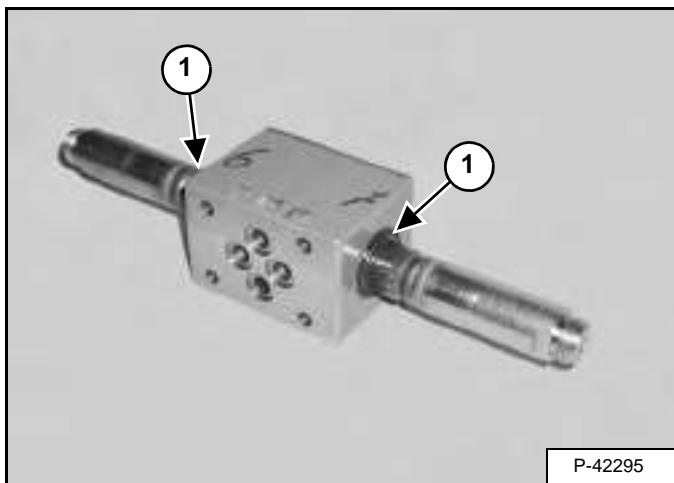

Install an O-ring (Item 1) [Figure 20-110-18] on each shaft.

Figure 20-110-19

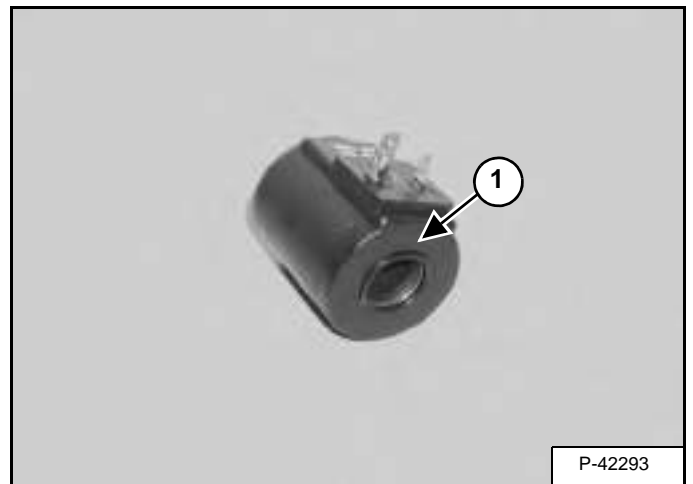

Install the O-ring (Item 1) [Figure 20-110-19] on the two solenoids.

Figure 20-110-20

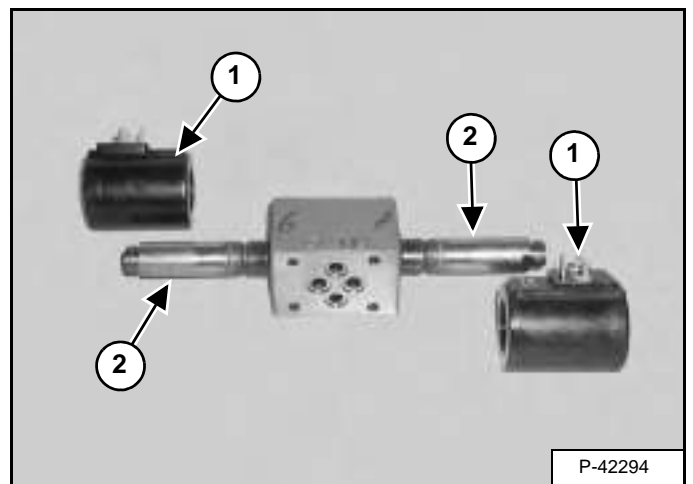

Install the solenoids (Item 1) on the shafts (Item 2) [Figure 20-110-20].

## STEERING MODE VALVE BLOCK (CONT'D)

### Assembly (Cont'd)

Figure 20-110-21

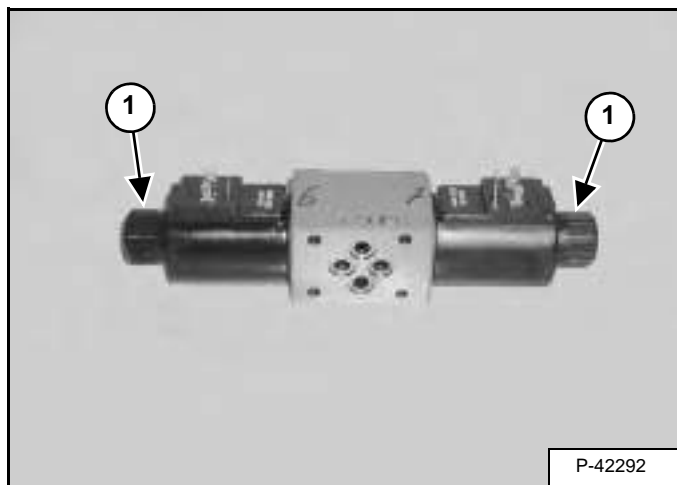

Install the nuts (Item 1) [Figure 20-110-21] on each shaft and hand tighten.

**NOTE: Do not overtighten the nuts.**

Figure 20-110-22

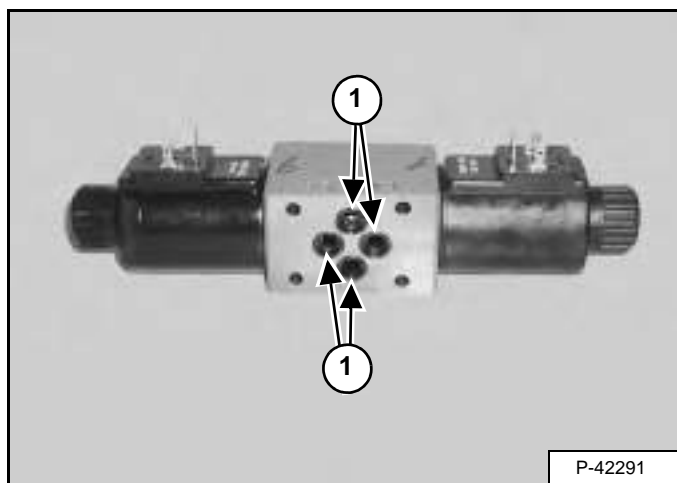

Install the four O-rings (Item 1) [Figure 20-110-22] on the housing.

## BRAKE VALVE

### Removal And Installation

Figure 20-120-1

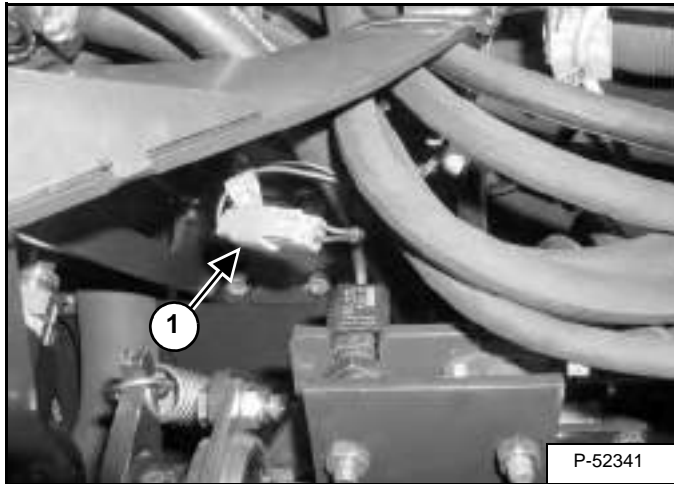

Remove the dash cover / column cover (See "Removal And Installation" on page 50-130-1.)

Unplug the connector (Item 1) [Figure 20-120-1] from the brake light switch.

Figure 20-120-2

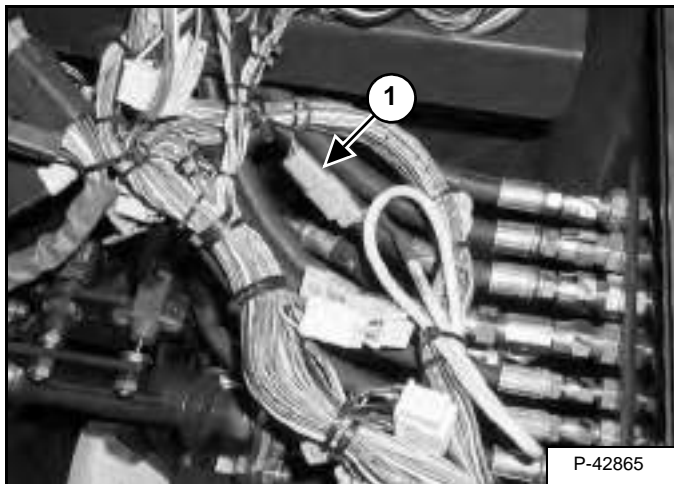

Unplug the connector (Item 1) [Figure 20-120-2] from the inching switch.

Figure 20-120-3

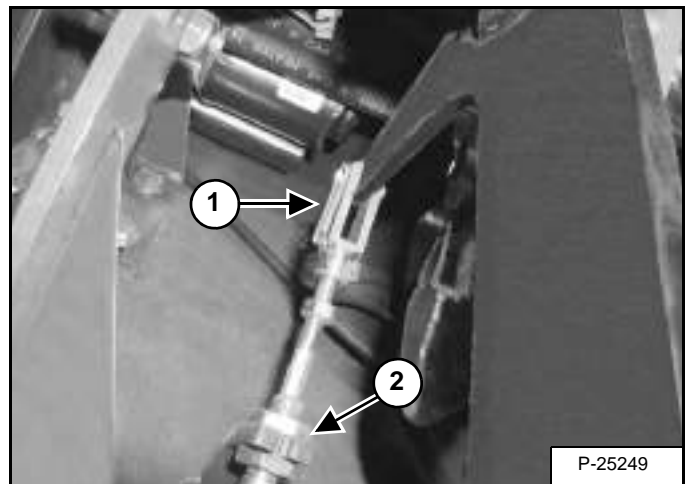

Remove the accelerator cable (Item 1) from the pedal and mounting bracket (Item 2) [Figure 20-120-3].

Figure 20-120-4

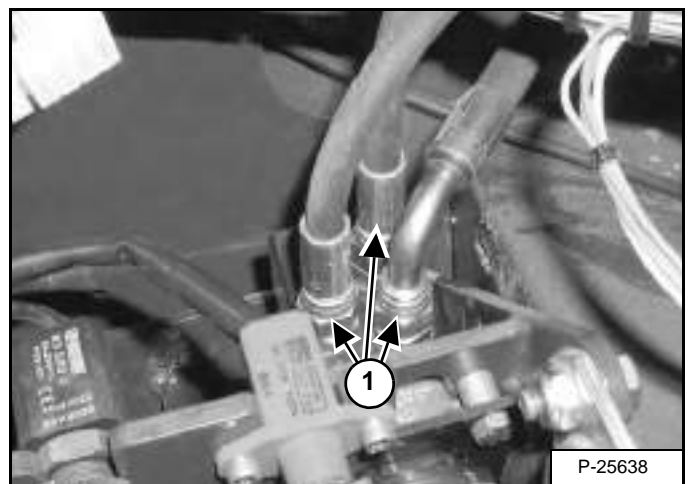

Remove the three hoses (Item 1) [Figure 20-120-4] from the brake valve.

**NOTE: Mark hoses for correct installation.**

## IMPORTANT

When repairing hydrostatic and hydraulic systems, clean the work area before disassembly and keep all parts clean. Always use caps and plugs on hoses, tubelines and ports to keep dirt out. Dirt can quickly damage the system.

I-2003-0888

## BRAKE VALVE (CONT'D)

### Removal and Installation (Cont'd)

Figure 20-120-5

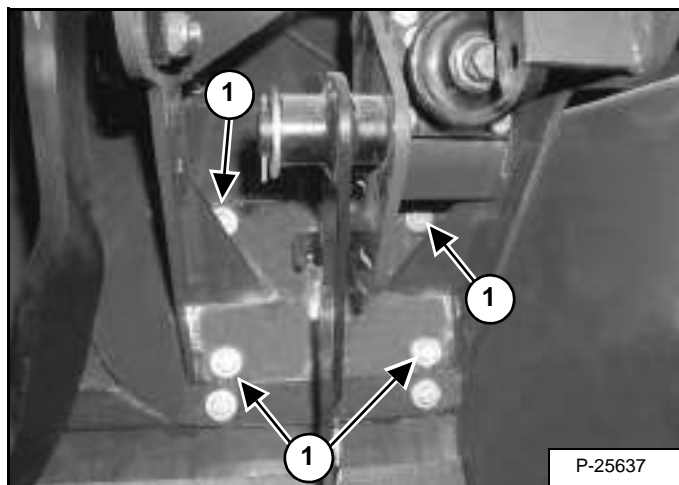

Remove the mounting bolts (Item 1) [Figure 20-120-5].

Remove the pedal assembly.

### Disassembly And Assembly

Figure 20-120-6

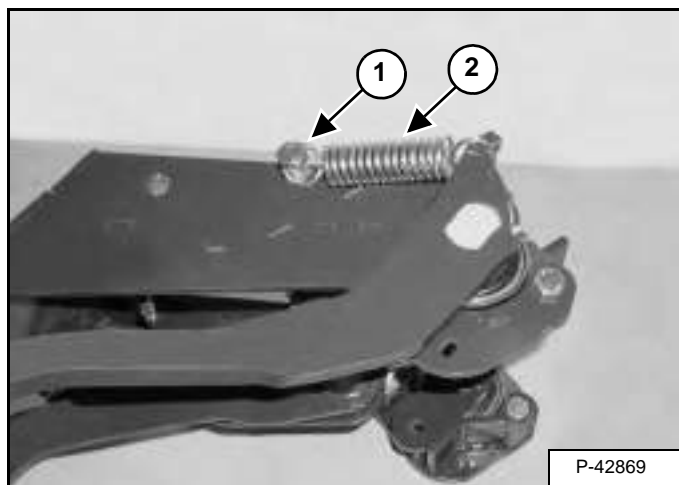

Remove the bolt (Item 1) and spring (Item 2) [Figure 20-120-6].

Figure 20-120-7

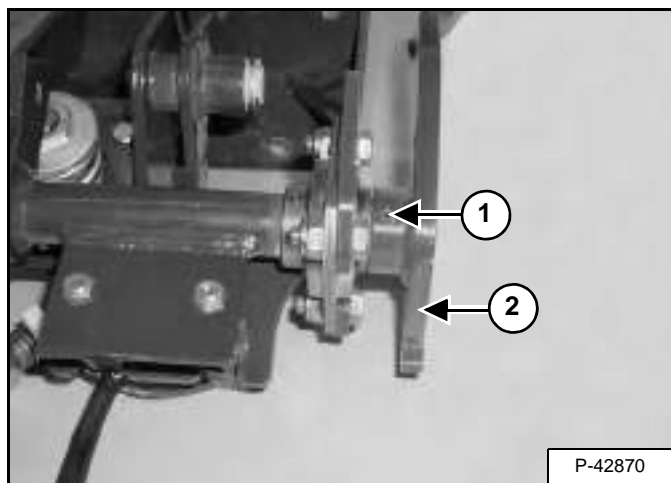

Remove the roll pin (Item 1) and pedal (Item 2) [Figure 20-120-7].

Figure 20-120-8

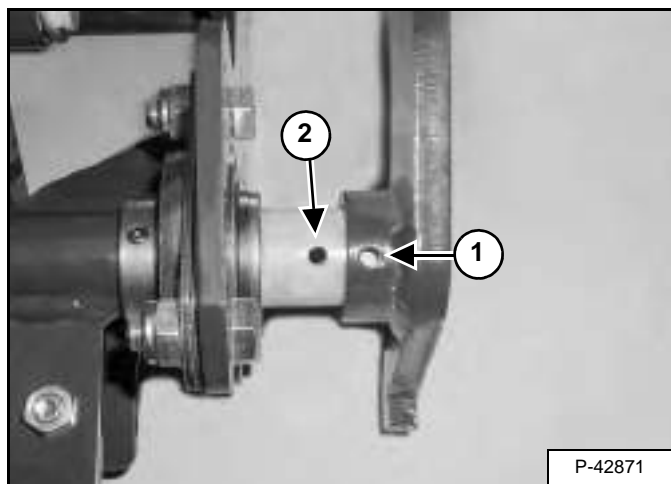

**Assembly:** Align the hole (Item 1) in the pedal with the hole (Item 2) [Figure 20-120-8] in the shaft.

## BRAKE VALVE (CONT'D)

### Disassembly And Assembly (Cont'd)

Figure 20-120-9

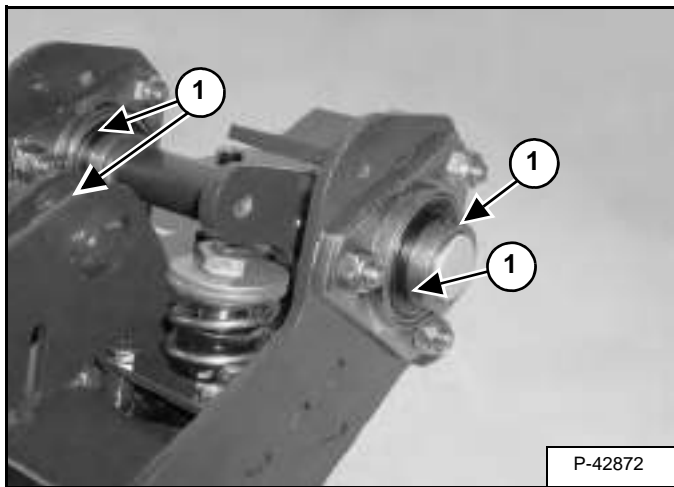

Loosen the two set screws (Item 1) [Figure 20-120-9] on the two bearings.

Figure 20-120-10

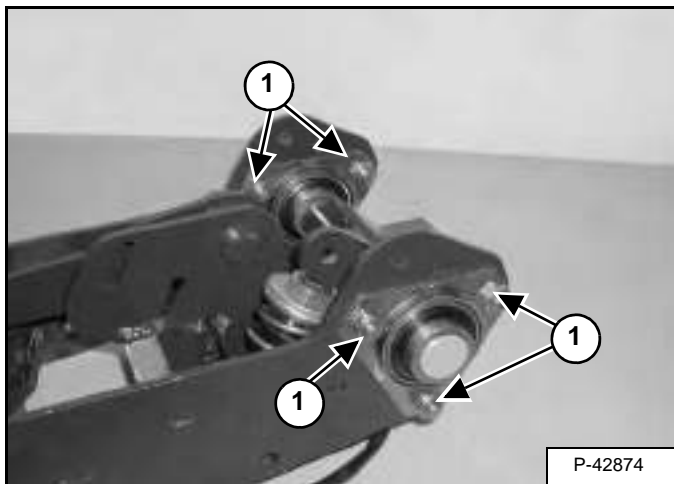

Remove the three bolts (Item 1) [Figure 20-120-10] from both bearing flanges.

Figure 20-120-11



Remove the shaft and bearing assembly [Figure 20-120-11].

Figure 20-120-12

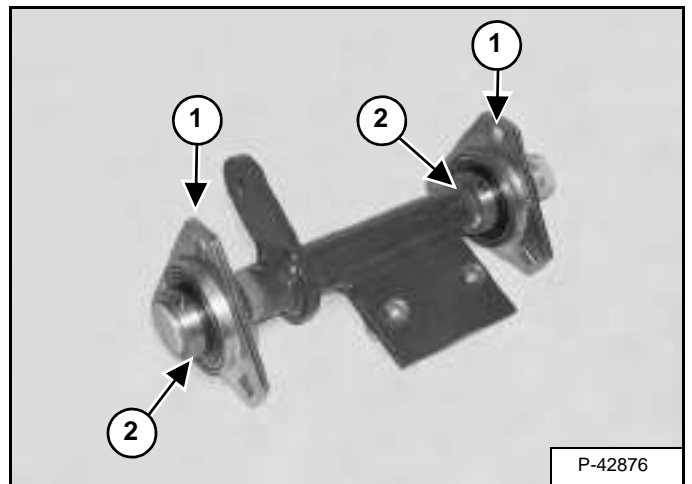

Remove the flanges (Item 1) and bearings (Item 2) [Figure 20-120-12].

## BRAKE VALVE (CONT'D)

### Disassembly And Assembly (Cont'd)

Figure 20-120-13

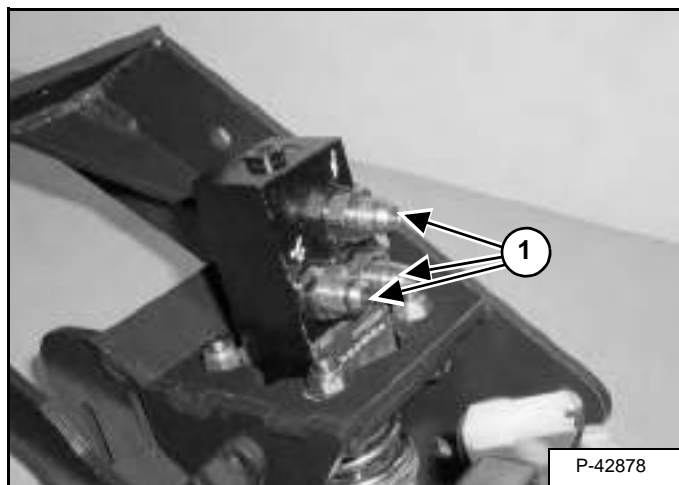

Remove the three fittings (Item 1) [Figure 20-120-13] from the brake valve.

Figure 20-120-14

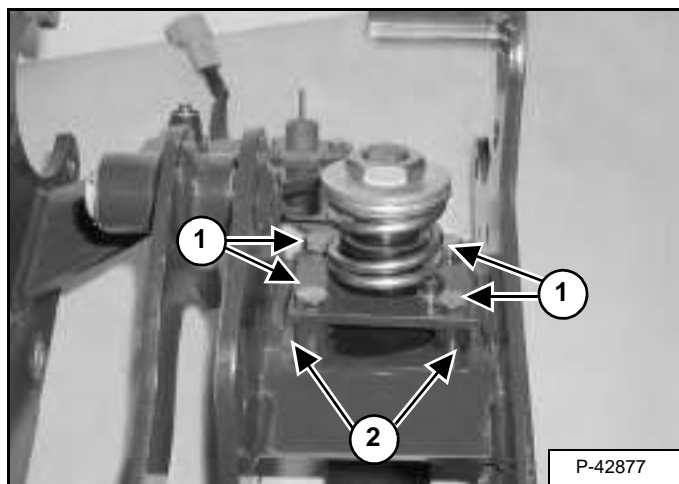

Remove the four bolts (Item 1) spacers (Item 2) [Figure 20-120-14] and nuts from the brake valve.

Figure 20-120-15

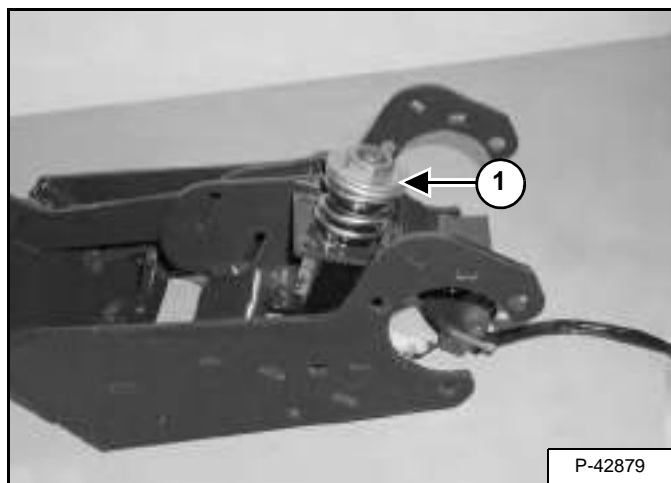

Remove the brake valve (Item 1) [Figure 20-120-15]



## GEAR PUMP

### Removal And Installation

Raise the boom and install the boom stop. (See "Installing The Approved Boom Stop" on page 10-150-1)

Stop the engine.

Relieve the hydraulic pressure. Drain the hydraulic reservoir. (See "Replacing Hydraulic Fluid" on page 10-100-2.)

## WARNING

Hydraulic fluid escaping under pressure can have sufficient force to enter a person's body by penetrating the skin. This can cause serious injury and possible death if proper medical treatment by a physician familiar with this injury is not received immediately.

W-2145-0290

## IMPORTANT

When repairing hydrostatic and hydraulic systems, clean the work area before disassembly and keep all parts clean. Always use caps and plugs on hoses, tubelines and ports to keep dirt out. Dirt can quickly damage the system.

I-2003-0888

Figure 20-130-1

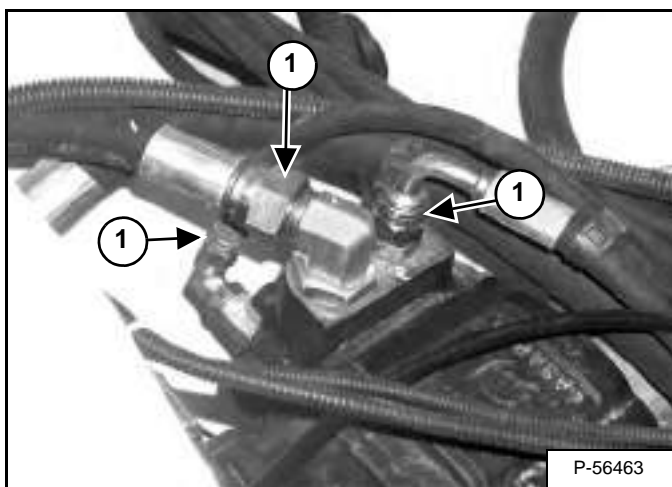

Remove the three hoses (Item 1) [Figure 20-130-1] from the backside of the pump.

Figure 20-130-2

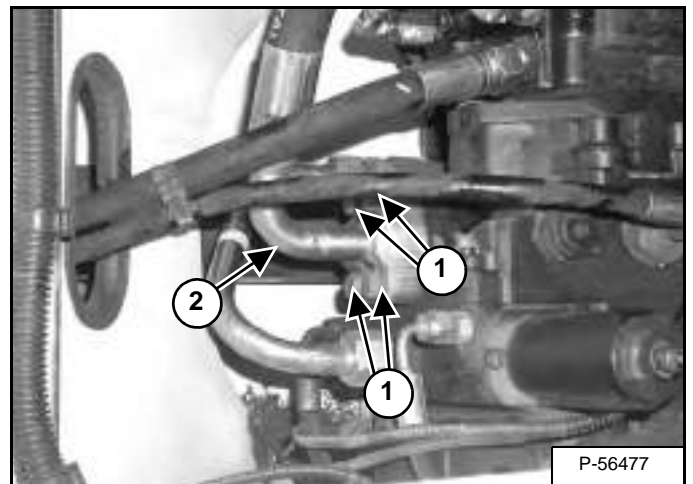

Remove the four bolts (Item 1) and remove the hose (Item 2) [Figure 20-130-2] from the hydrostatic pump.

Figure 20-130-3

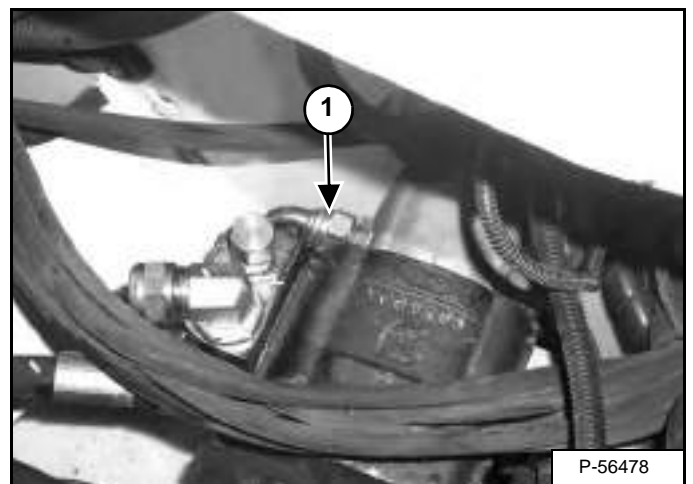

Remove the hose (Item 1) [Figure 20-130-3] from the backside of the gear pump.

## GEAR PUMP (CONT'D)

### Removal And Installation (Cont'd)

Figure 20-130-4

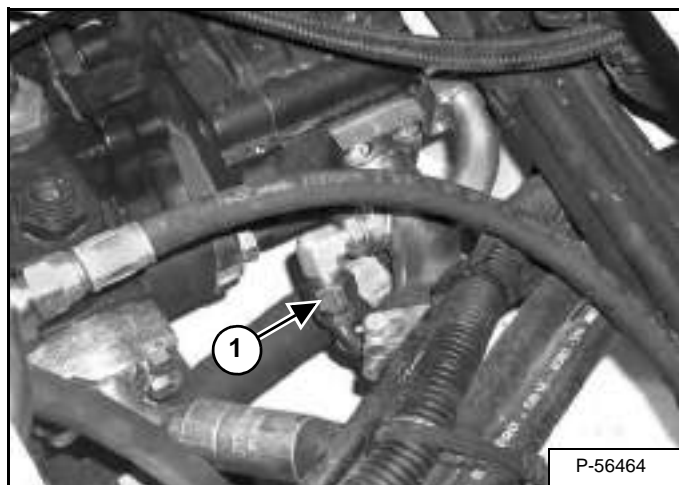

Remove the hose (Item 1) [Figure 20-130-4].

Figure 20-130-5

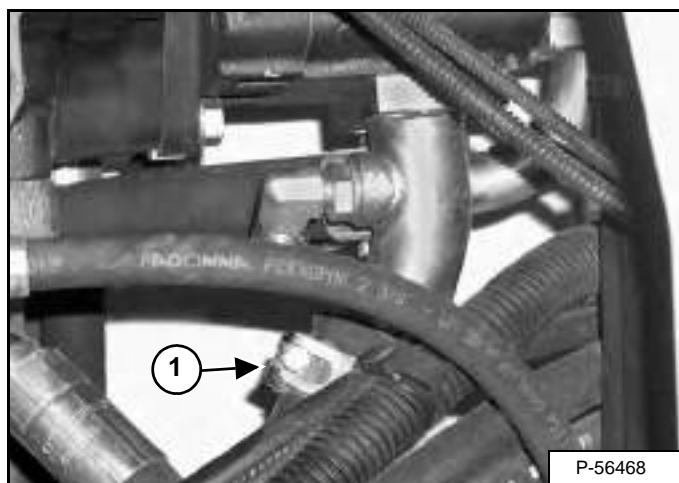

Loosen the hose clamp (Item 1) [Figure 20-130-5] and remove the hose.

Figure 20-130-6

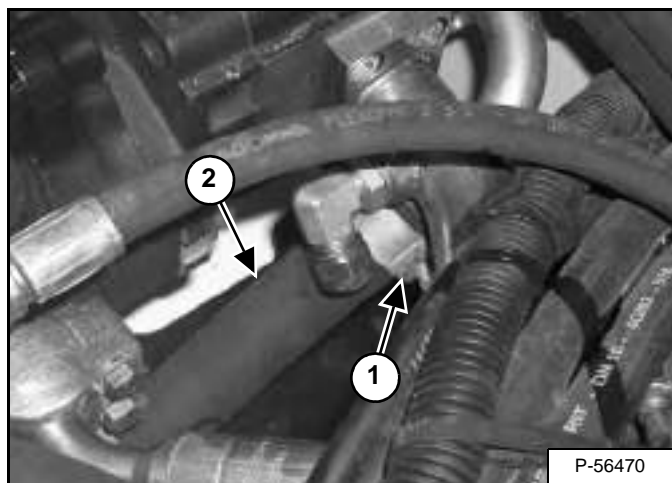

Loosen the hose clamp (Item 1) and remove the hose (Item 2) [Figure 20-130-6].

Figure 20-130-7

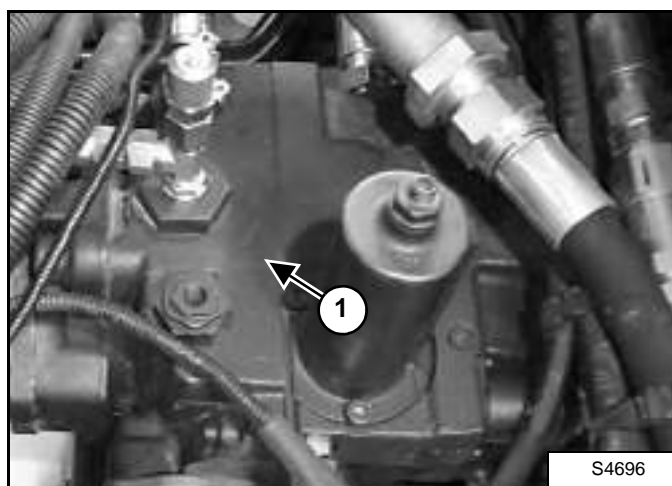

Install a chain hoist and lifting strap to lift and support the gear pump [Figure 20-130-7].

Remove the two mounting bolts (Item 1) [Figure 20-130-7] from the gear pump.

**Installation:** Tighten the mounting bolts to 52-59 ft.-lb. (50-80 N•m) torque.

---

## GEAR PUMP (CONT'D)

### Removal And Installation (Cont'd)

Figure 20-130-8



Remove the gear pump [Figure 20-130-8].

**NOTE:** It may be necessary to reposition any hose or wires.

# GEAR PUMP (CONT'D)

## Parts Identification

1. Fitting
2. O-ring
3. Spring
4. Spring Seat
5. Spool
6. Screen
7. Orifice Spool
8. Bolt
9. Housing
10. Plug
11. Bolt
12. Washer
13. Cover
14. Seal Ring
15. Housing
16. Backup Ring
17. Seal Ring
18. Holder
19. Gear
20. Drive Shaft
21. Mount Plate
22. Thrust Plate
23. Mount Plate
24. Seal
25. Snap ring

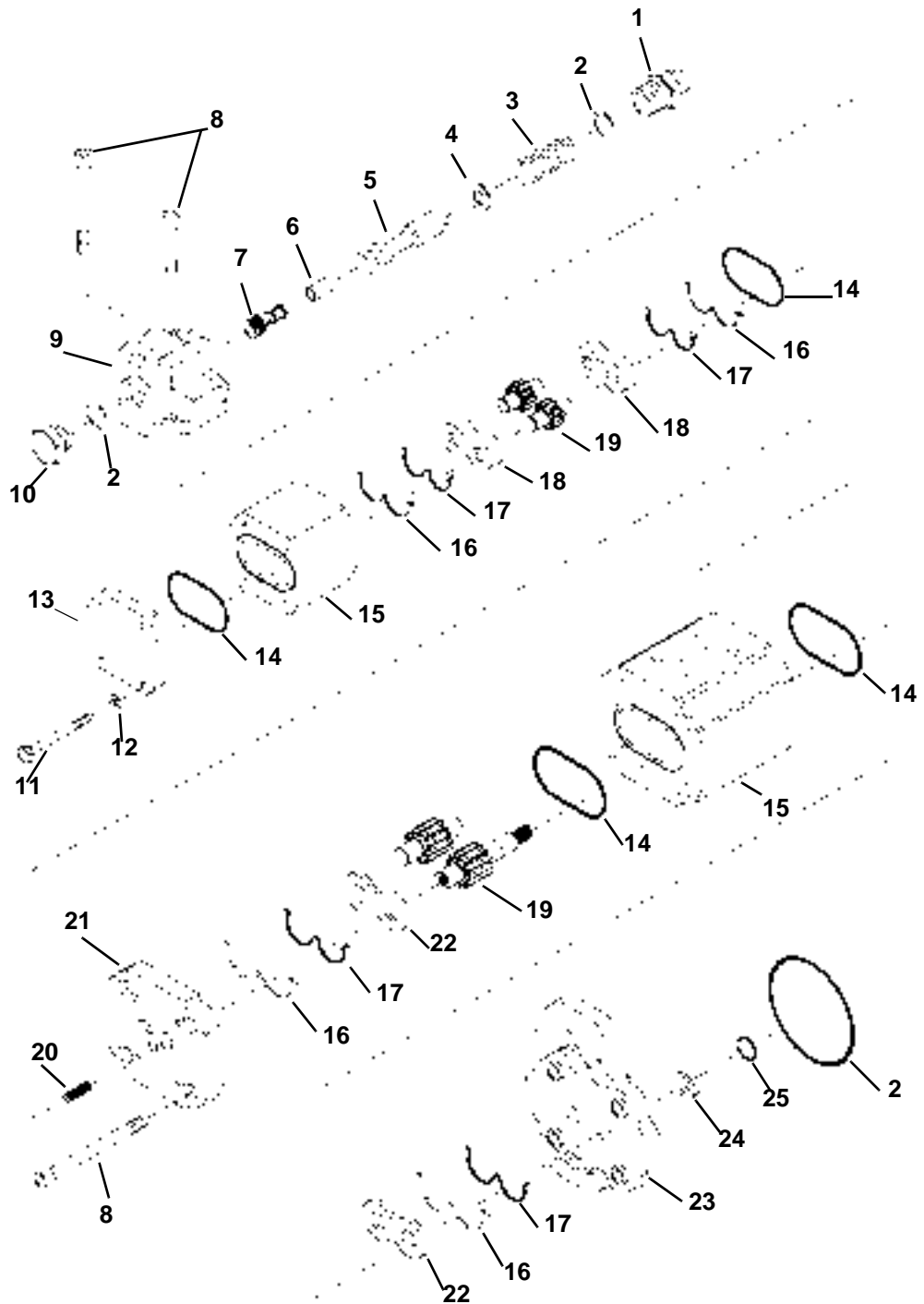

MS1423

## GEAR PUMP (CONT'D)

### Disassembly And Assembly

# IMPORTANT

When repairing hydrostatic and hydraulic systems, clean the work area before disassembly and keep all parts clean. Always use caps and plugs on hoses, tubelines and ports to keep dirt out. Dirt can quickly damage the system.

I-2003-0888

Figure 20-130-9

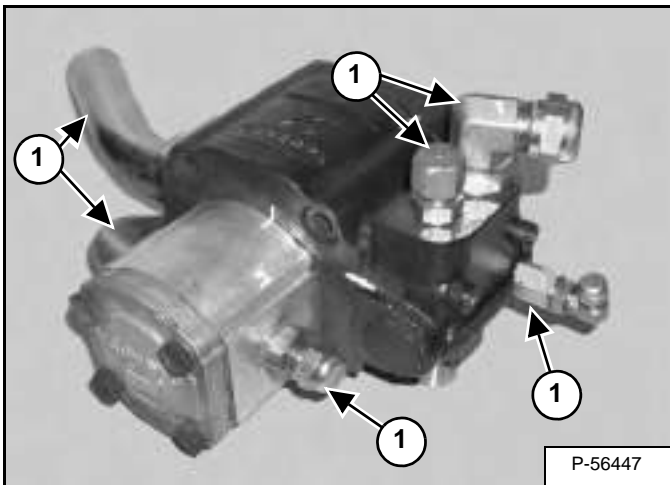

Mark the pump housing for correct assembly and remove the fittings (Item 1) [Figure 20-130-9].

Figure 20-130-10

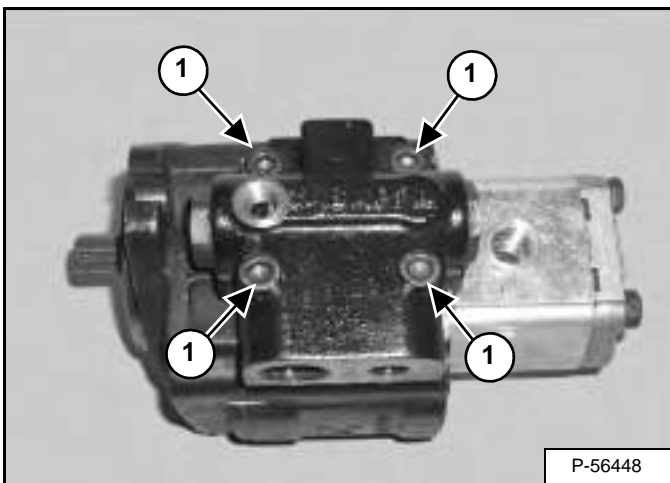

Remove the four bolts (Item 1) [Figure 20-130-10].

**Assembly:** Tighten the bolts to 25 ft.-lb. (33 N•m) torque.

Figure 20-130-11

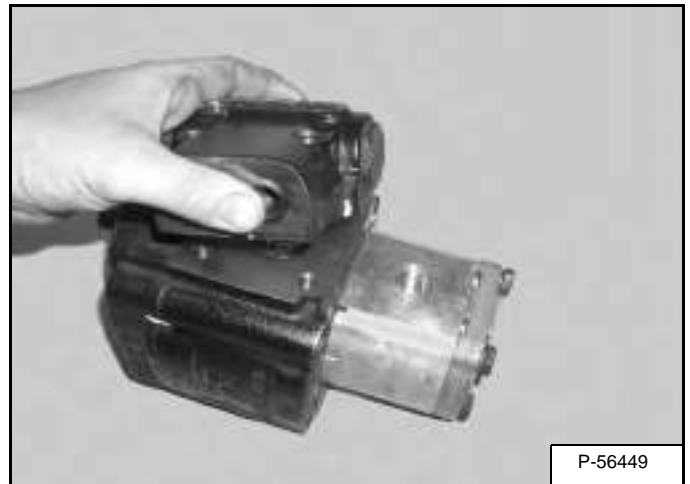

Remove the flow divider from the housing [Figure 20-130-11].

Figure 20-130-12

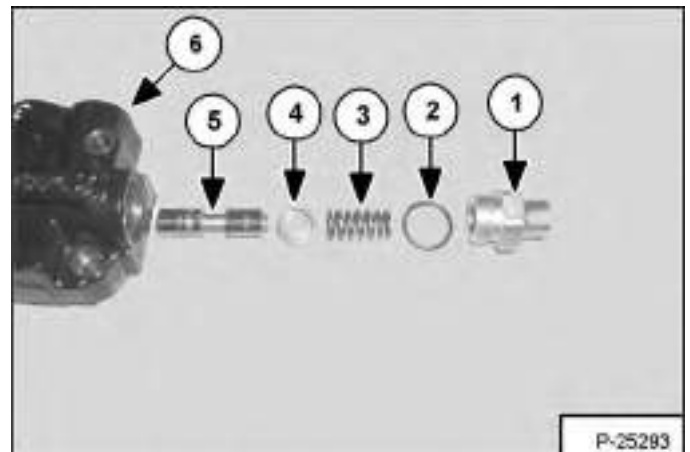

Remove the fitting (Item 1), O-ring (Item 2), spring (Item 3), spring seat (Item 4) and spool (Item 5) from the housing (Item 6) [Figure 20-130-12].

**NOTE:** Always use new O-rings.

## GEAR PUMP (CONT'D)

### Disassembly And Assembly (Cont'd)

Figure 20-130-13

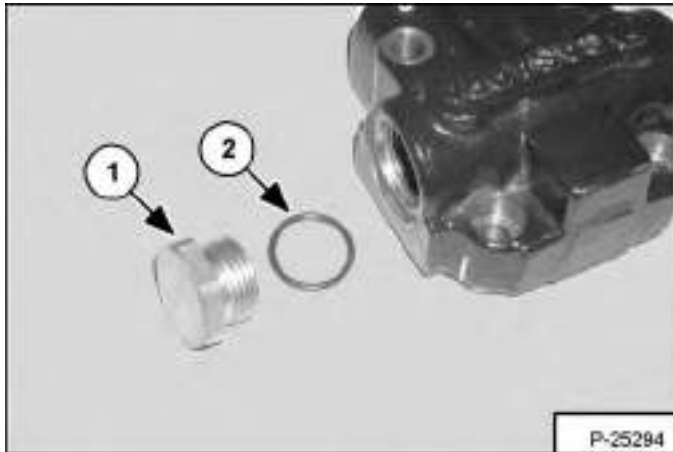

Remove the plug (Item 1) and O-ring (Item 2) [Figure 20-130-13] from the housing.

Figure 20-130-14

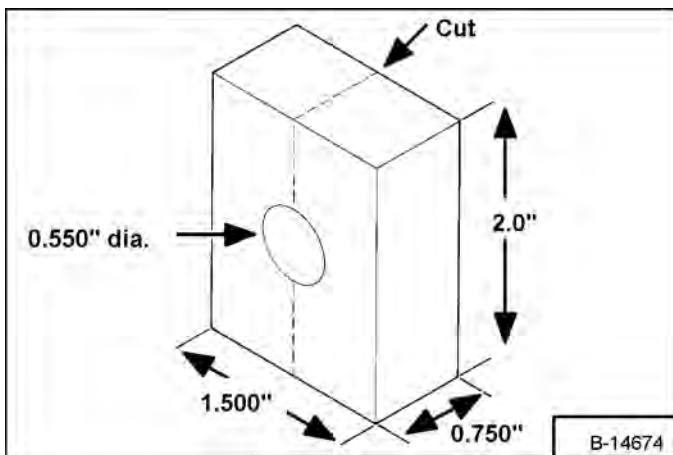
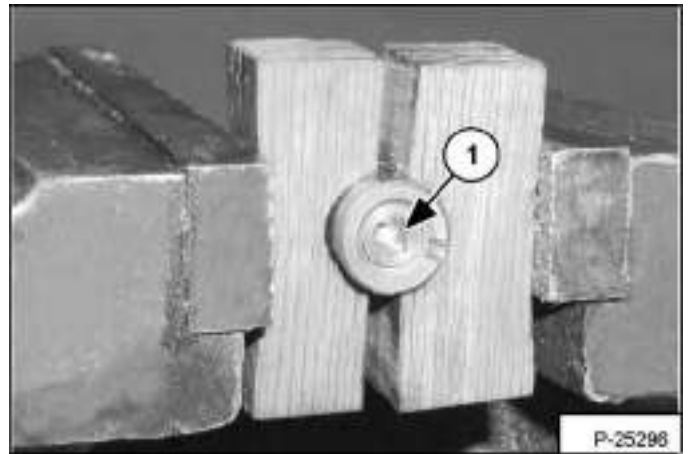

Figure 20-130-15



To remove the orifice assembly (Item 1) [Figure 20-130-15] from the spool, a holding fixture will have to be made from a 0.750 inch thick x 1.500 inches wide x 2.0 inches long (19 mm) thick x 38 mm wide x 50 mm long) piece of hardwood. Drill a 0.550 inch (14 mm) hole in the center of the hardwood block. Cut the block lengthwise [Figure 20-130-14].

Place both halves of the hardwood block around the spool. Clamp the blocks in a vise [Figure 20-130-15].

**NOTE:** Do not use anything other than hardwood blocks to grip the spool, or the spool will be damaged.

Figure 20-130-16

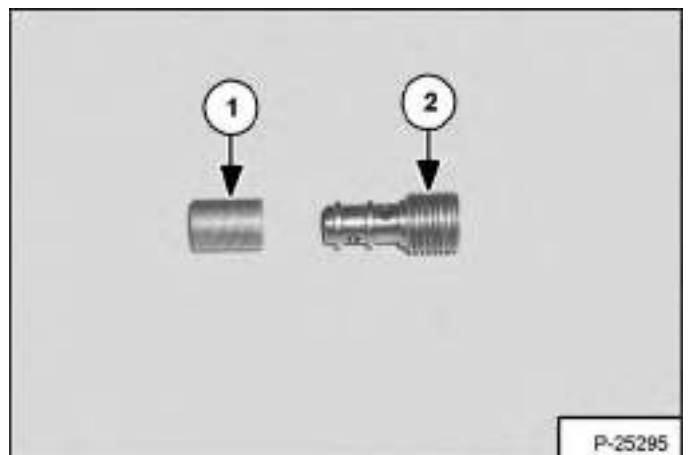

Remove the screen (Item 1) from the orifice (Item 2) [Figure 20-130-16] and clean.

## GEAR PUMP (CONT'D)

### Disassembly And Assembly (Cont'd)

Figure 20-130-17

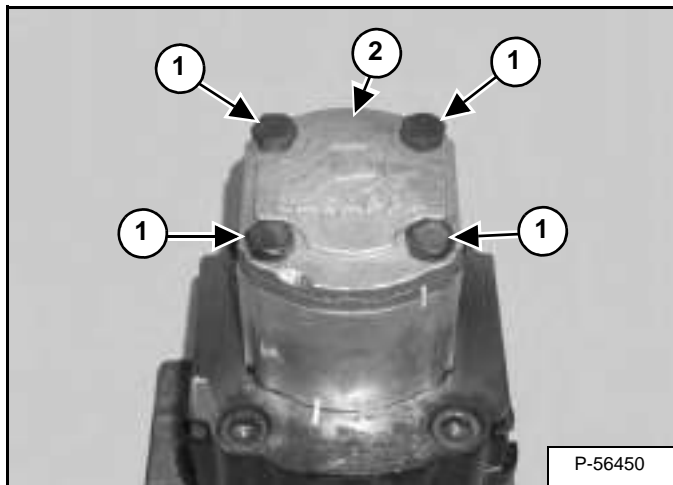

Remove the four bolts (Item 1) and cover (Item 2) [Figure 20-130-17].

Figure 20-130-18

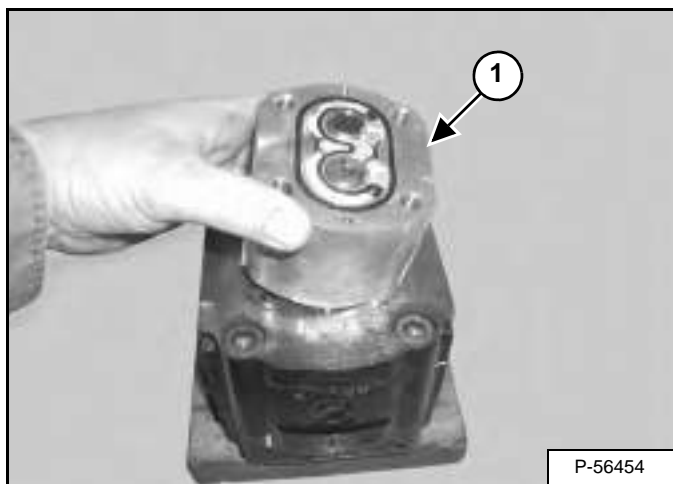

Remove the housing / gear assembly (Item 1) [Figure 20-130-18] from the main housing.

Figure 20-130-19

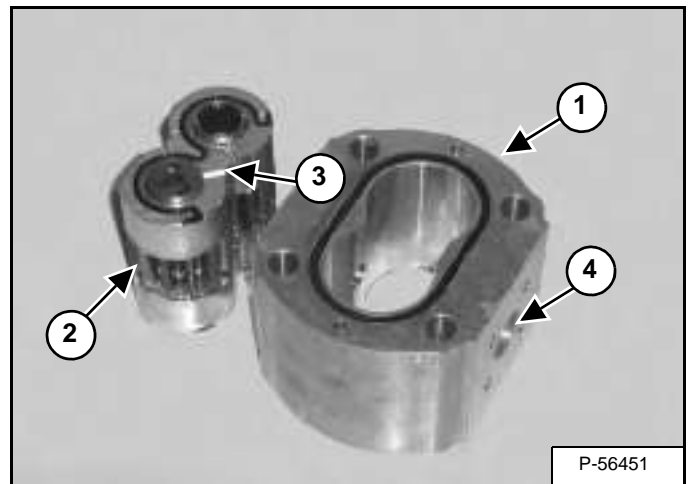

Remove the housing (Item 1) from the gear assembly (Item 2) [Figure 20-130-19].

**Assembly:** The position of the small opening (Item 3) on the gear holders will point towards the large port (Item 4) [Figure 20-130-19] on the housing.

Figure 20-130-20

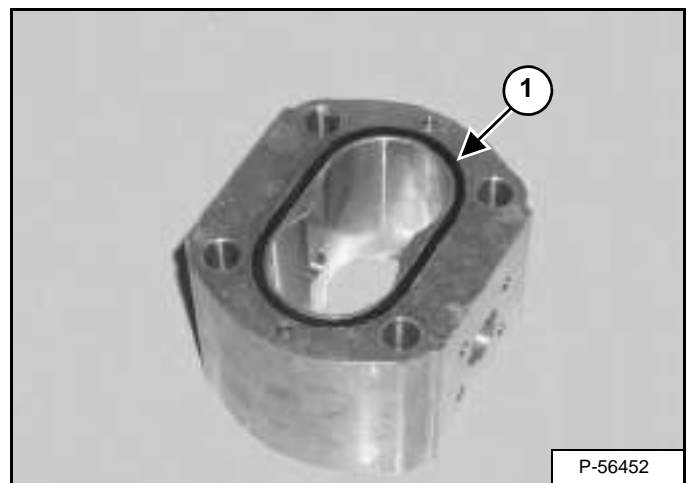

Remove both O-rings (Item 1) [Figure 20-130-20] from the housing.

## GEAR PUMP (CONT'D)

### Disassembly And Assembly (Cont'd)

Figure 20-130-21

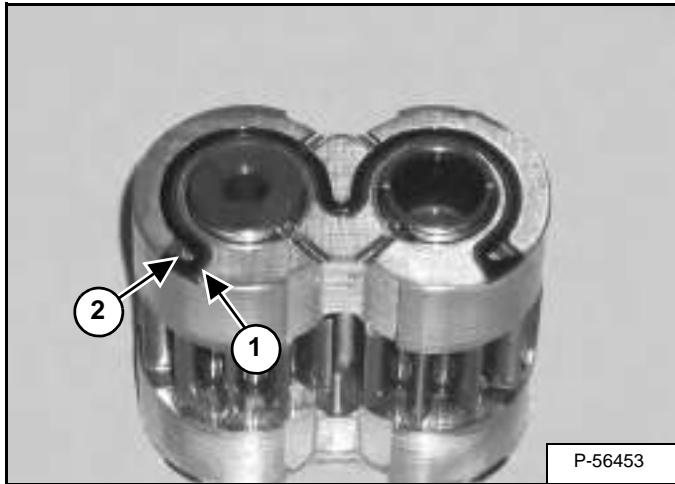

Remove the backup ring (Item 1) and seal ring (Item 2) [Figure 20-130-21] from the gear holder.

**Assembly:** The seal ring (Item 2) [Figure 20-130-21] is installed onto the gear holder first followed by the backup ring.

Figure 20-130-22

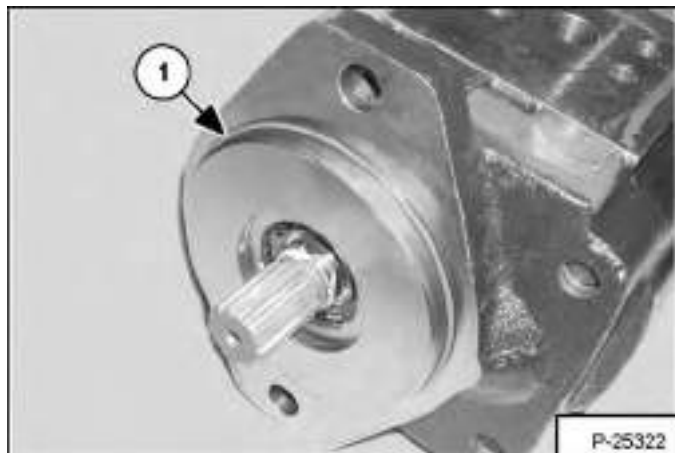

Remove and discard the O-ring (Item 1) [Figure 20-130-22] from the flange.

Figure 20-130-23

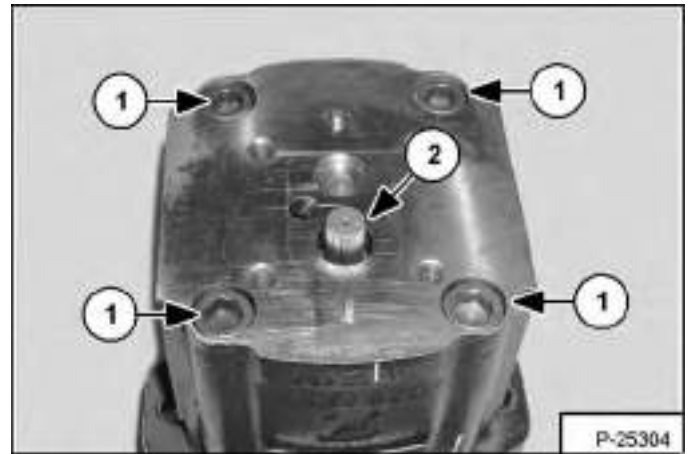

Remove the four bolts (Item 1) and drive shaft (Item 2) [Figure 20-130-23].

**Assembly:** Tighten the bolts to 25 ft.-lb. (33 N•m) torque.

Figure 20-130-24



Turn the housing over and remove the mount plate [Figure 20-130-24].



## GEAR PUMP (CONT'D)

### Disassembly And Assembly (Cont'd)

Figure 20-130-25

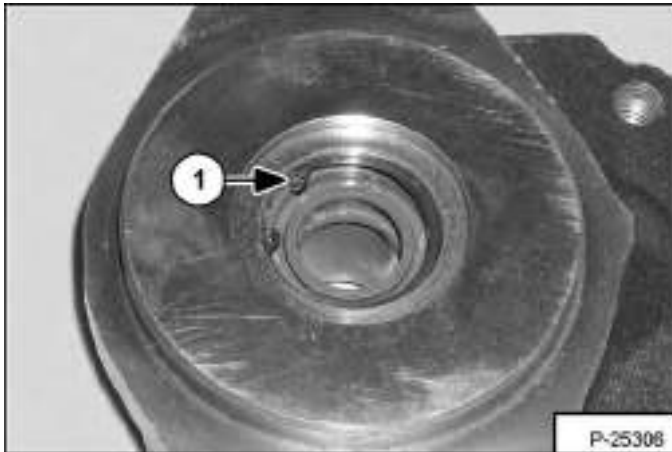

Remove the snap ring (Item 1) [Figure 20-130-25].

Figure 20-130-26

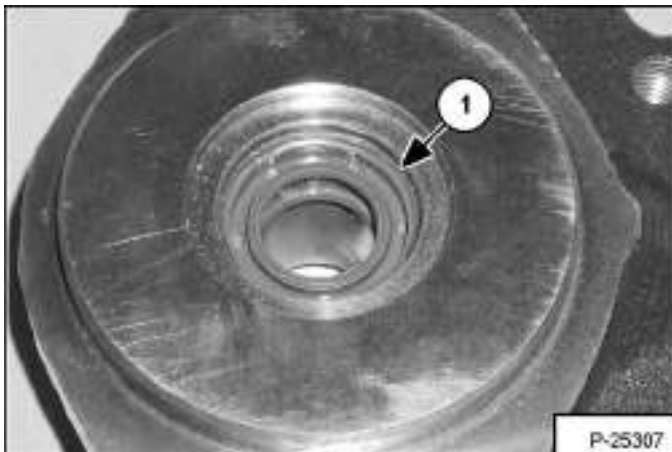

Remove the shaft seal (Item 1) [Figure 20-130-26].

Figure 20-130-27

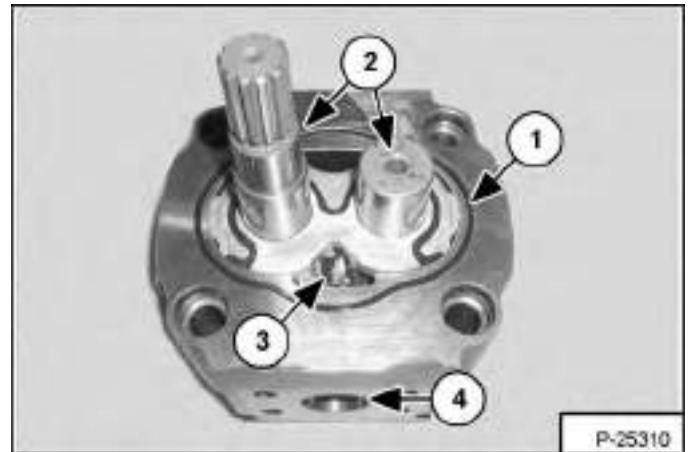

Remove the O-ring (Item 1) and gear assembly (Item 2) [Figure 20-130-27] from the housing.

**Assembly:** The position of the V portion (Item 3) on the thrust plate must point towards the larger port (Item 4) [Figure 20-130-27] on the housing.

Figure 20-130-28

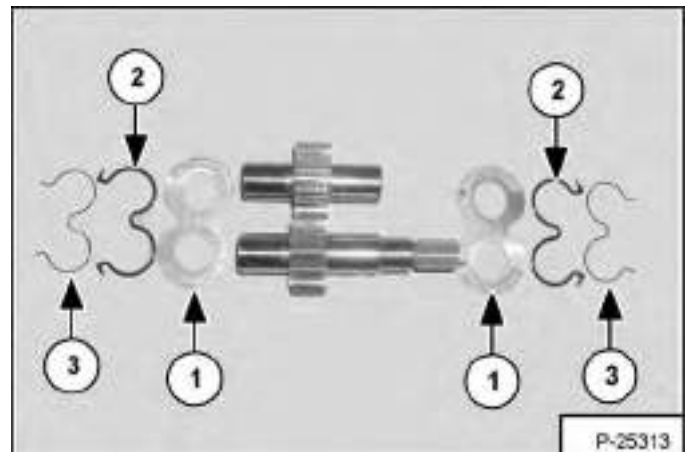

Remove the two thrust plates (Item 1), seal ring (Item 2) and backup ring (Item 3) [Figure 20-130-28] from the gears.

**Assembly:** The seal ring (Item 2) will be installed on the thrust plate (Item 1) first followed by the backup ring (Item 3) [Figure 20-130-28].



**Bobcat®**

## FAN MOTOR

### Removal And Installation

# IMPORTANT

When repairing hydrostatic and hydraulic systems, clean the work area before disassembly and keep all parts clean. Always use caps and plugs on hoses, tubelines and ports to keep dirt out. Dirt can quickly damage the system.

I-2003-0888

Drain the radiator. (See "Replacing The Coolant" on page 10-70-2.)

Figure 20-140-1

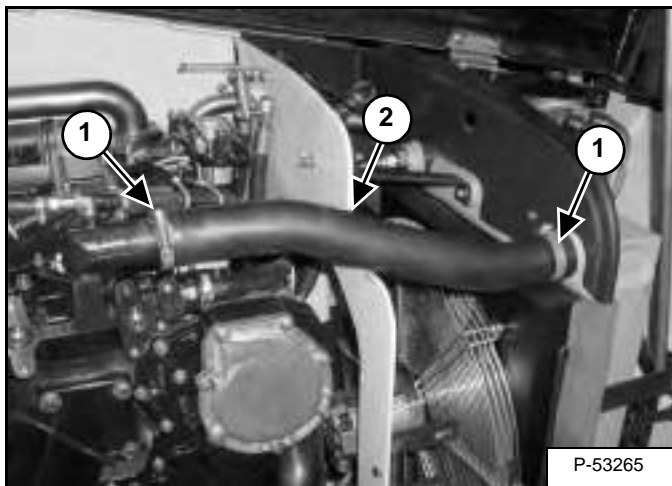

Loosen the two hose clamps (Item 1) and remove the radiator hose (Item 2) [Figure 20-140-1].

Figure 20-140-2

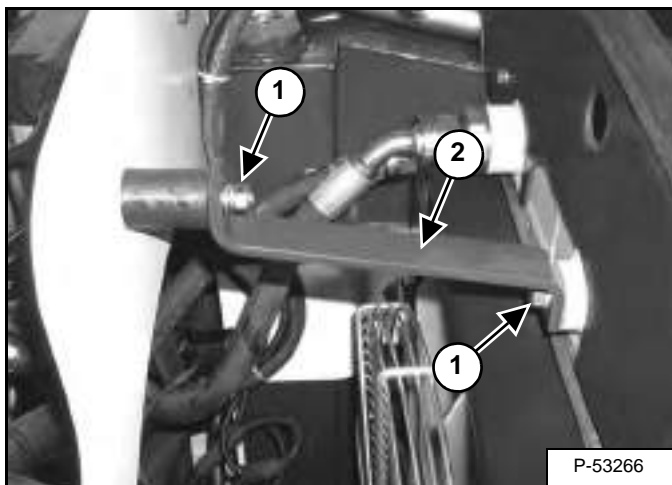

Remove the two mounting bolts (Item 1) and remove the radiator support (Item 2) [Figure 20-140-2].

Figure 20-140-3

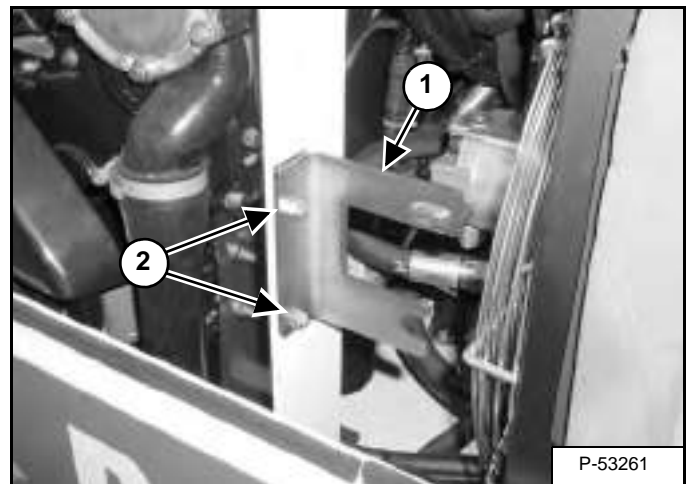

Mark the location of the hood latch (Item 1). Remove the two mounting bolts (Item 2) [Figure 20-140-3]. Remove the hood latch.

Figure 20-140-4

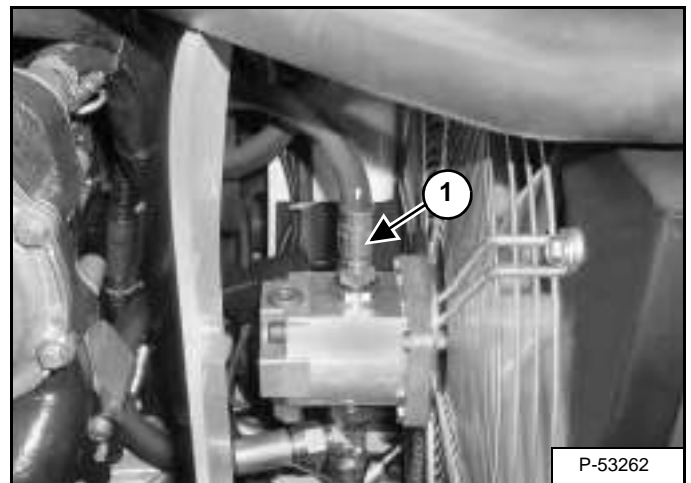

Remove the top hose (Item 1) [Figure 20-140-4] from the fan motor.

## FAN MOTOR (CONT'D)

### Removal And Installation (Cont'd)

Figure 20-140-5

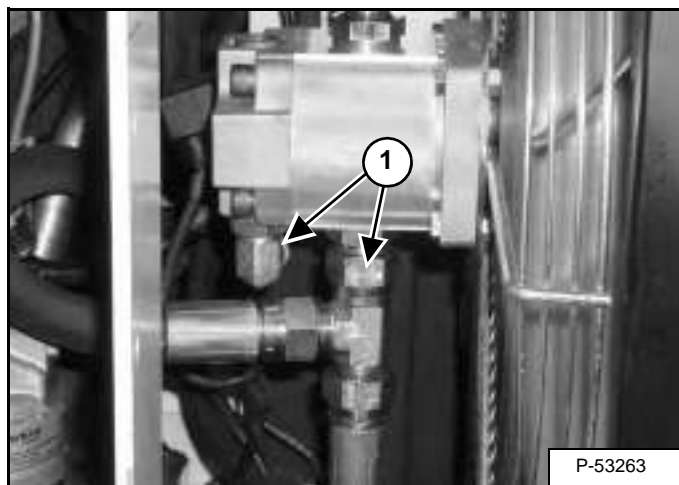

Remove the three hoses (Item 1) [Figure 20-140-5] from the bottom of the fan motor.

Figure 20-140-6

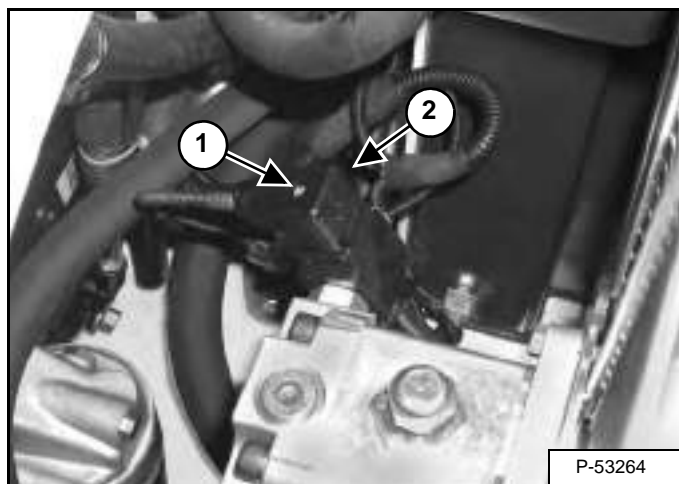

Loosen the screw (Item 1) and unplug the connector (Item 2) [Figure 20-140-6].

Figure 20-140-7

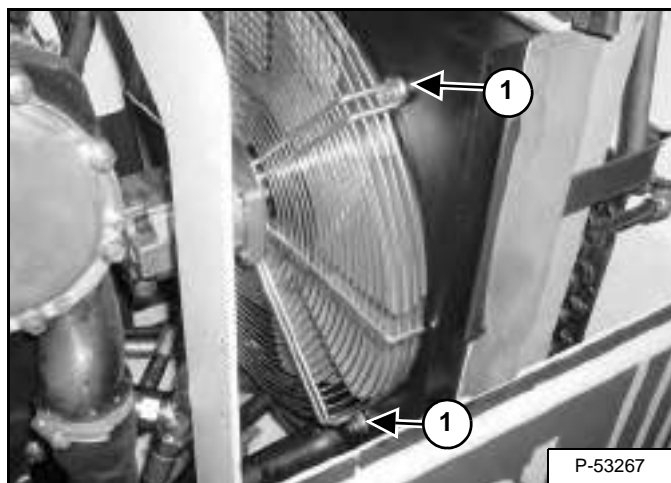
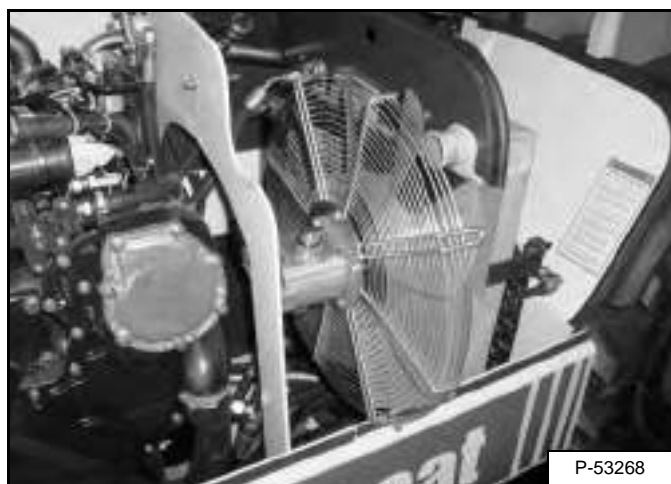

Figure 20-140-8



Tilt the cooler forward and carefully remove the fan assembly [Figure 20-140-8].

Remove the two bolts (Item 1) [Figure 20-140-7] (both sides) from the fan guard.

## FAN MOTOR (CONT'D)

### Removal And Installation (Cont'd)

Figure 20-140-9

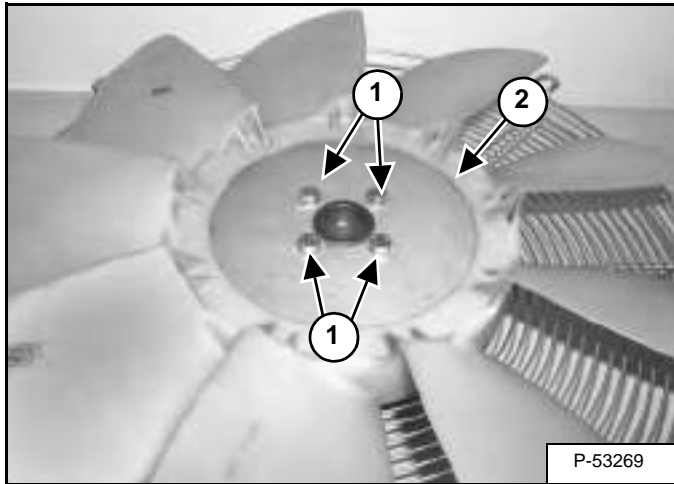

Remove the four bolts (Item 1) and remove the blade assembly (Item 2) [Figure 20-140-9] from the fan motor.

**NOTE:** Mark the direction of the fan for correct assembly.

Figure 20-140-10

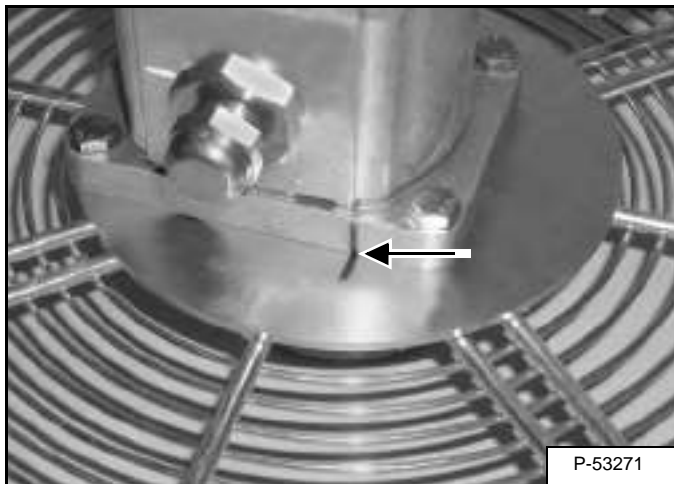

Mark the location of the fan motor to the fan guard for correct assembly [Figure 20-140-10].

Figure 20-140-11

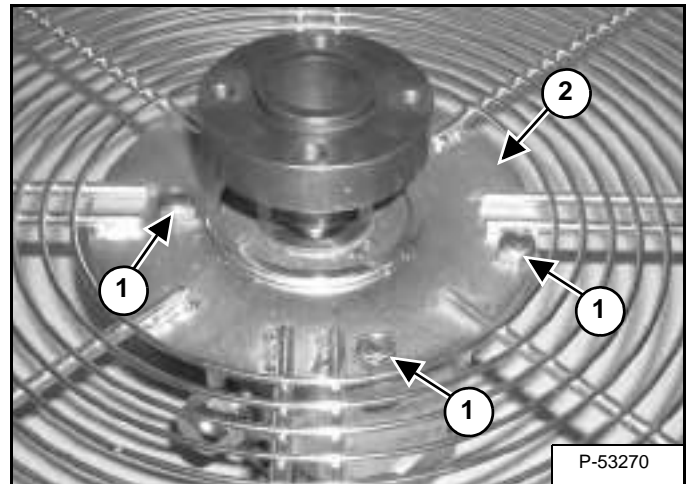

Remove the four fan guard mount bolts (Item 1) and remove the fan guard (Item 2) [Figure 20-140-11].

Figure 20-140-12

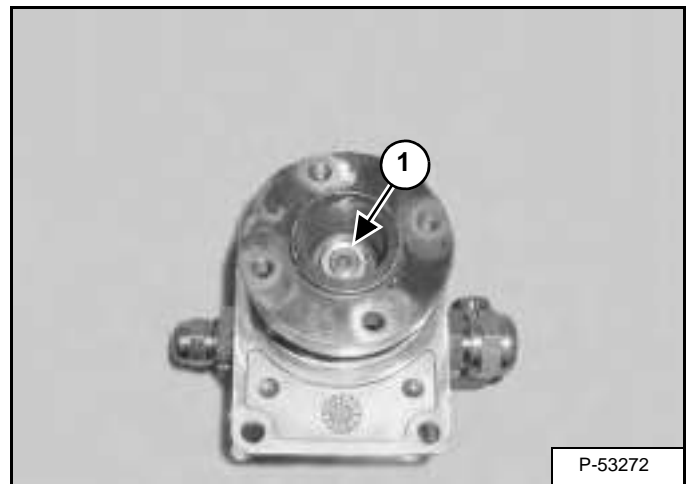

Remove the nut and lock washer (Item 1) [Figure 20-140-12].

---

## FAN MOTOR (CONT'D)

### Removal And Installation (Cont'd)

Figure 20-140-13

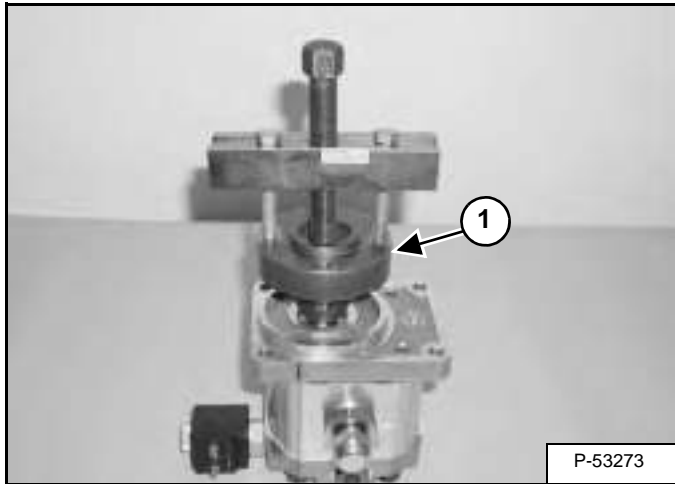

Remove the fan blade mounting flange (Item 1) **[Figure 20-140-13]** from the fan motor.

## FAN MOTOR (CONT'D)

### Parts Identification

- 1 Set of seals
- 2 Valve

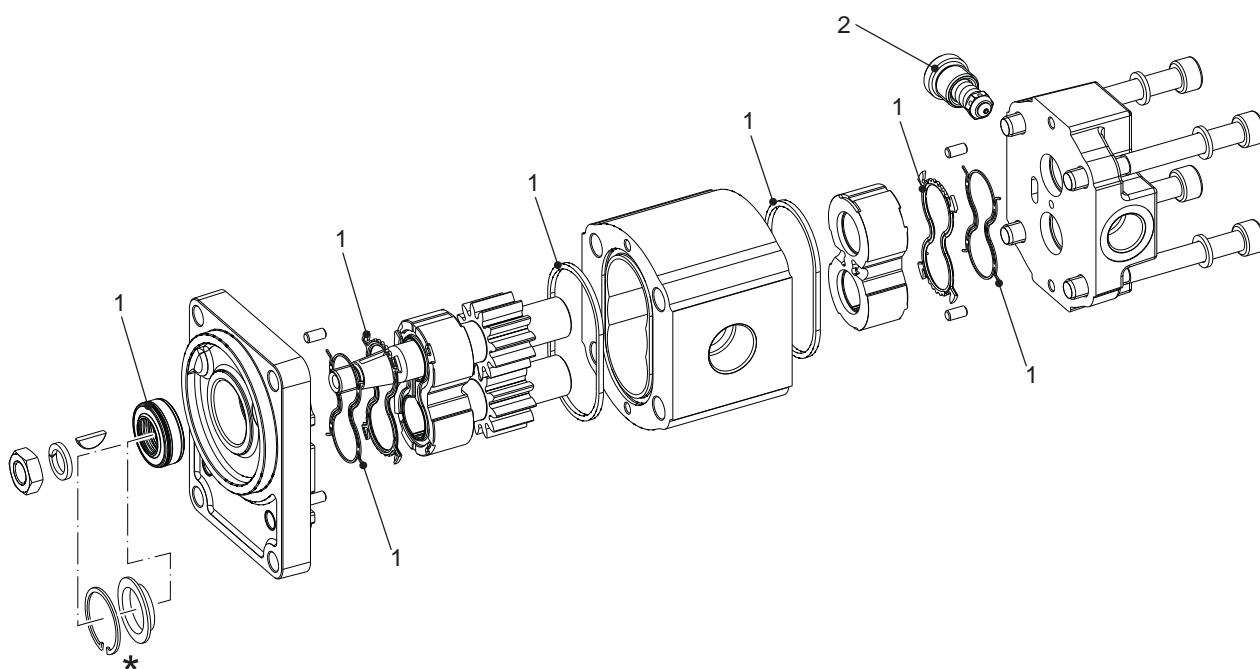

\* Older models

S2754

## FAN MOTOR (CONT'D)

### Disassembly And Assembly

# IMPORTANT

When repairing hydrostatic and hydraulic systems, clean the work area before disassembly and keep all parts clean. Always use caps and plugs on hoses, tubelines and ports to keep dirt out. Dirt can quickly damage the system.

I-2003-0888

Figure 20-140-14

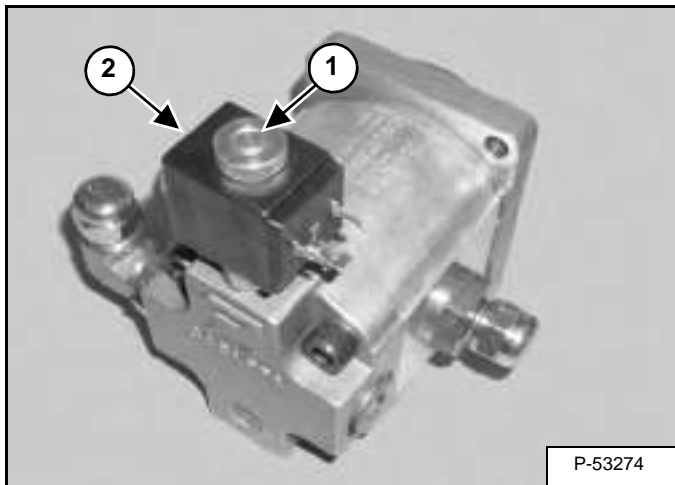

Remove the nut (Item 1) and solenoid (Item 2) [Figure 20-140-14].

Mark the housing for correct assembly.

Figure 20-140-15

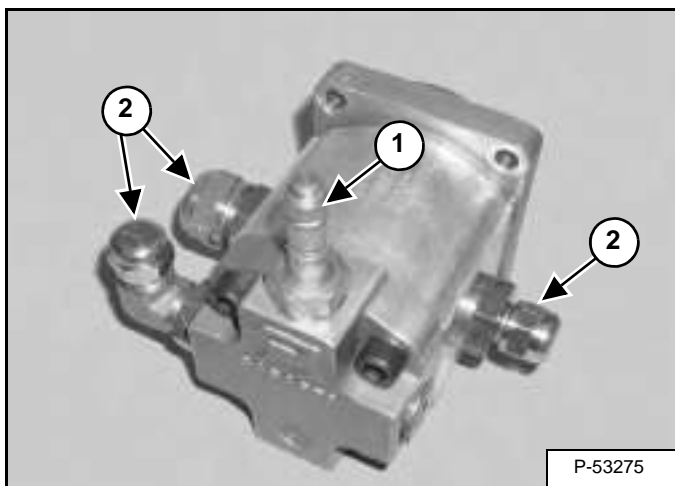

Remove the solenoid (Item 1) and three fittings (Item 2) [Figure 20-140-15].

Figure 20-140-16

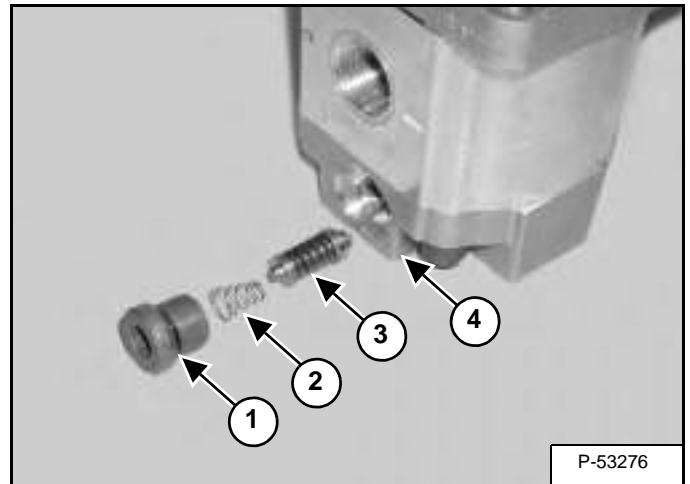

Remove the plug (Item 1), spring (Item 2) and check valve (Item 3) from the housing (Item 4) [Figure 20-140-16].

Figure 20-140-17

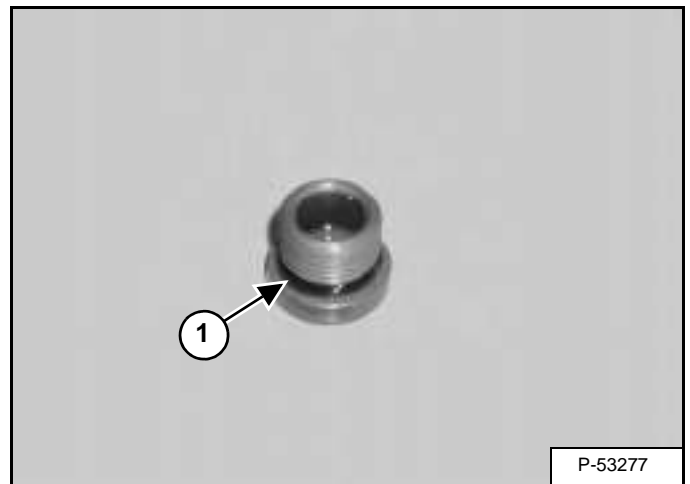

Remove the O-ring (Item 1) [Figure 20-140-17] from the plug. Replace as needed.



## FAN MOTOR (CONT'D)

### Disassembly And Assembly (Cont'd)

Figure 20-140-18

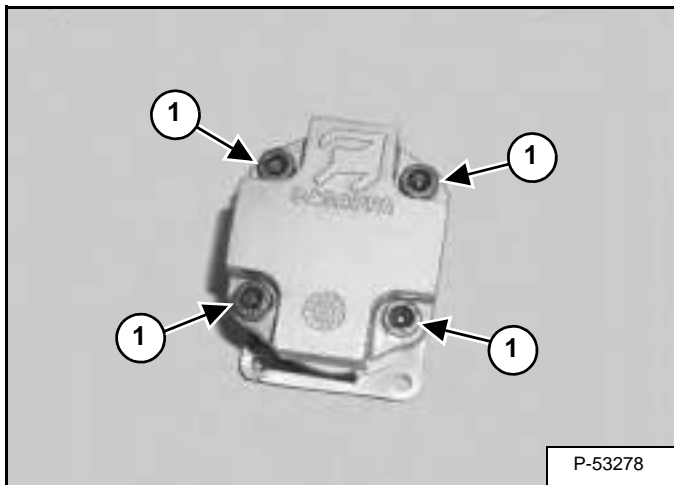

Remove the four bolts (Item 1) [Figure 20-140-18] from the end.

**Assembly:** Tighten bolts to 32-35 ft.-lb. (43-47 N•m) torque.

Figure 20-140-19

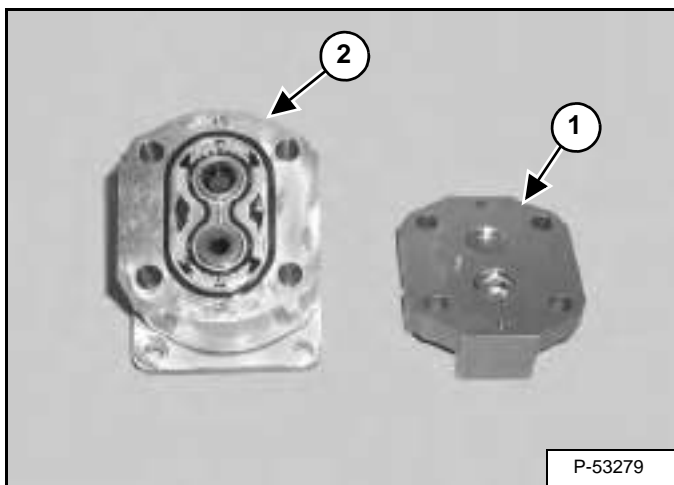

Remove the end cover (Item 1) from the main housing (Item 2) [Figure 20-140-19].

Figure 20-140-20

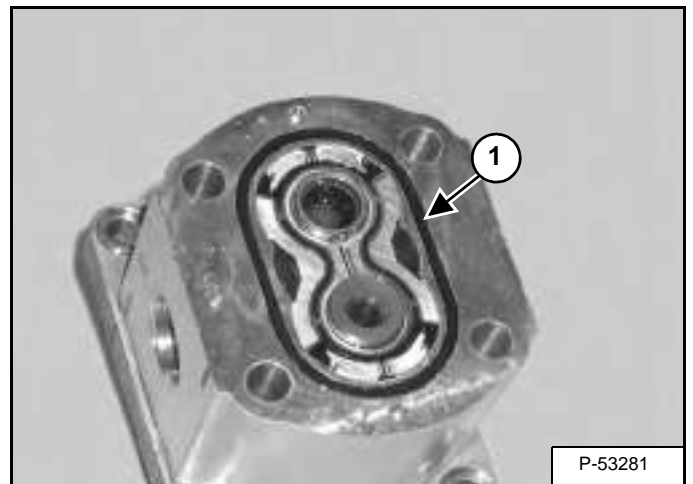
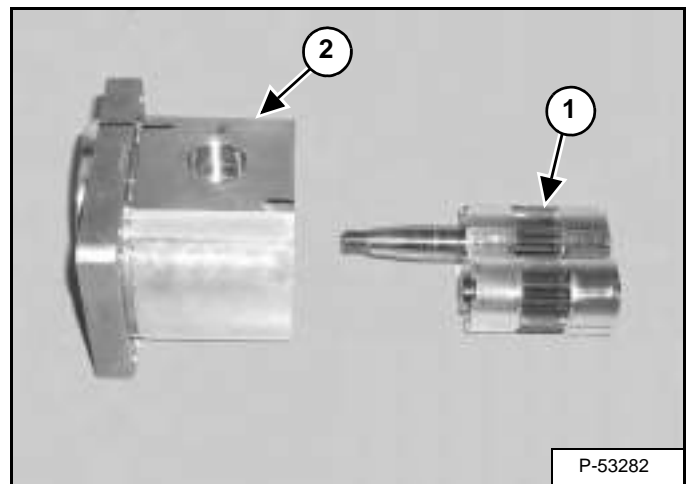

Figure 20-140-21



Remove the gear assembly (Item 1) from the housing (Item 2) [Figure 20-140-21].

Remove the quad ring (Item 1) [Figure 20-140-20] from the housing.

## FAN MOTOR (CONT'D)

### Disassembly And Assembly (Cont'd)

Figure 20-140-22

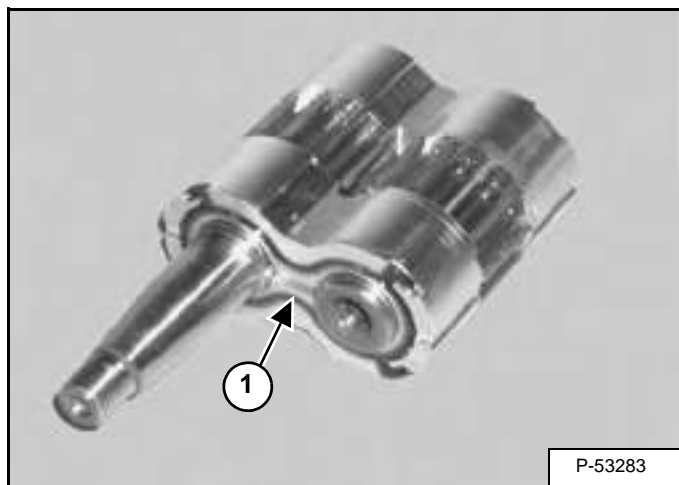

Remove the backup ring / seal (Item 1) [Figure 20-140-22] from the gear holder.

Figure 20-140-23

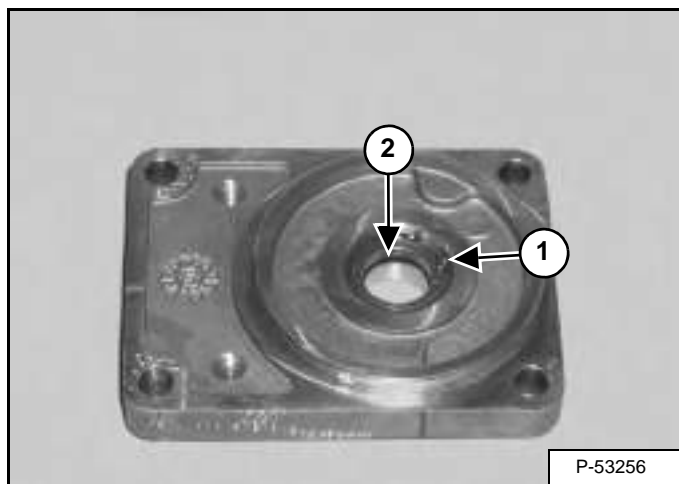

Remove the snap ring (Item 1) (Older Models Only) and remove the seal (Item 2) [Figure 20-140-23].

**Assembly:** The open part of the seal goes into the housing first.

Figure 20-140-24

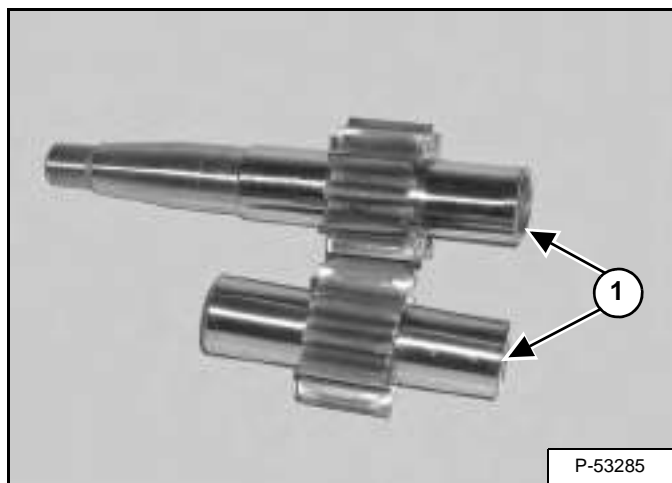

Inspect the gears (Item 1) [Figure 20-140-24] for damage or wear.

## HYDRAULIC RESERVOIR

### Removal And Installation

Remove the engine / hydrostatic assembly (See "Removal And Installation" on page 70-80-1.)

Figure 20-150-1

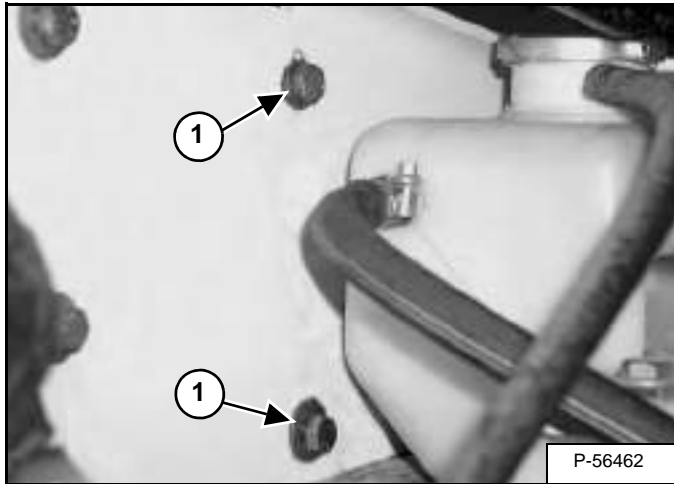

Remove the two bolts (Item 1) [Figure 20-150-1] behind the radiator overflow tank.

Figure 20-150-2

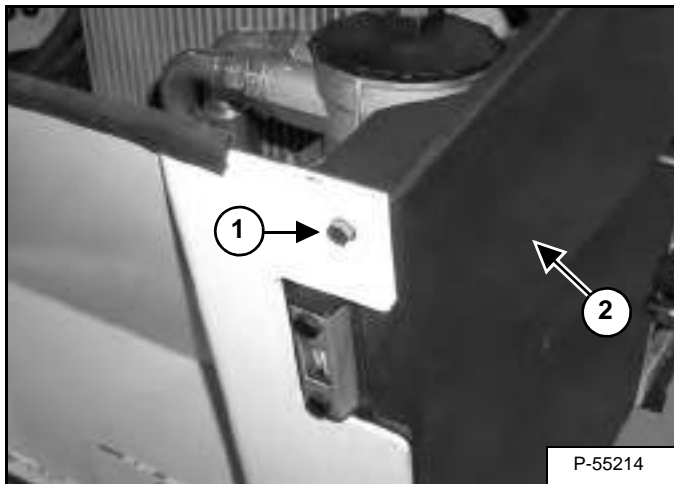

Remove the bolt (Item 1) and shield (Item 2) [Figure 20-150-2].

Figure 20-150-3

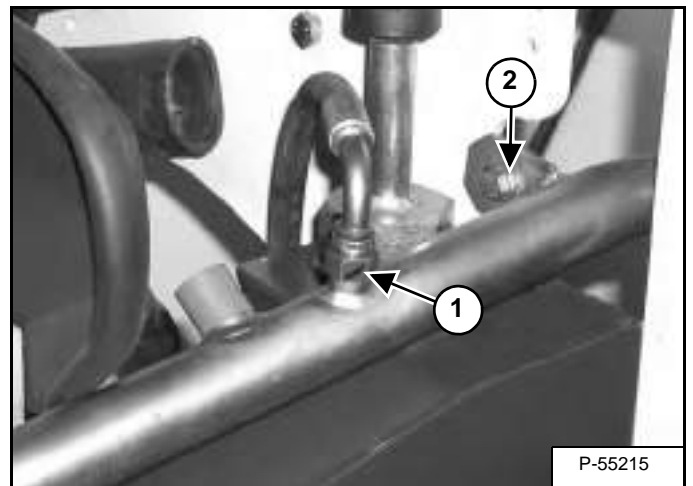

Remove the hose (Item 1) [Figure 20-150-3] from the tubeline.

Remove the mounting bolt (Item 2) [Figure 20-150-3].

Figure 20-150-4

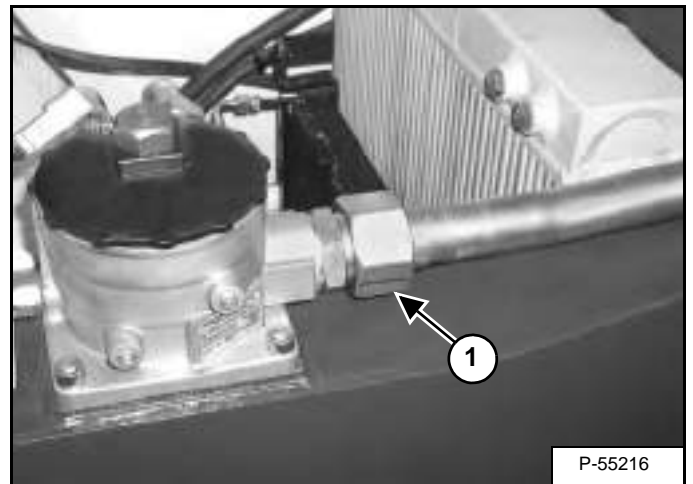

Loosen the nut (Item 1) [Figure 20-150-4] on the tubeline.

Remove the tubeline.

## HYDRAULIC RESERVOIR (CONT'D)

### Removal And Installation (Cont'd)

Figure 20-150-5

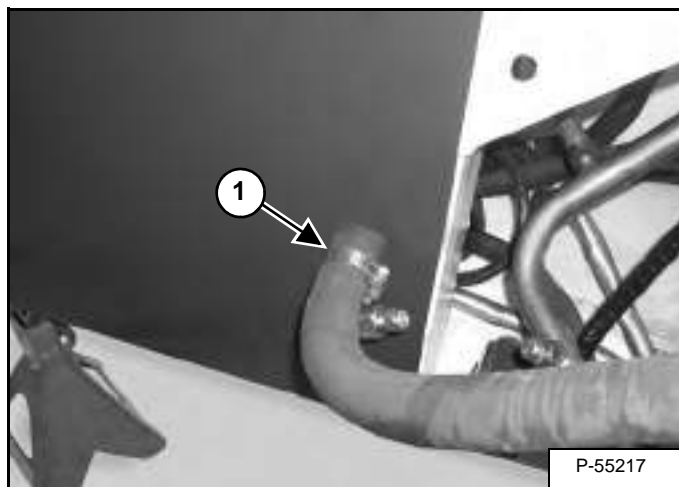

Remove the hose (Item 1) [Figure 20-150-5] from the tank.

Figure 20-150-6

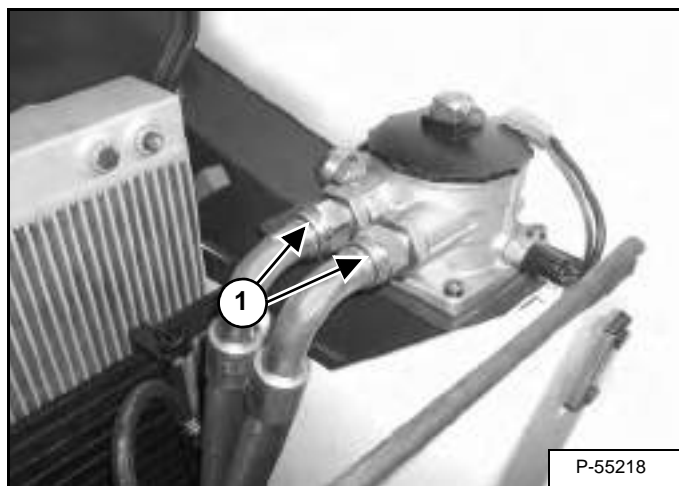

Remove the two hoses (Item 1) [Figure 20-150-6] from the filter.

Figure 20-150-7

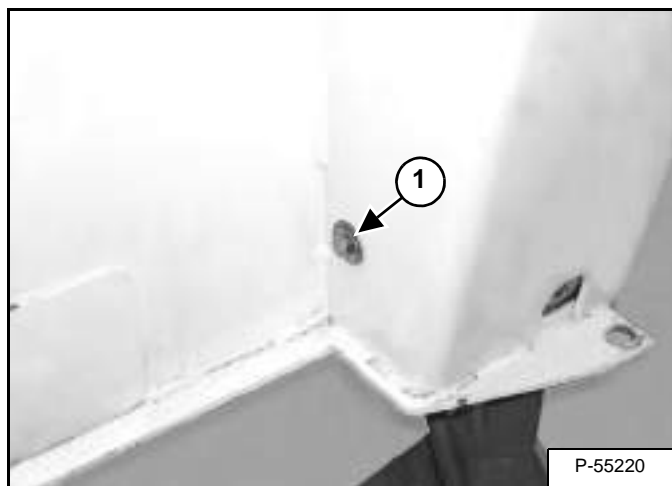
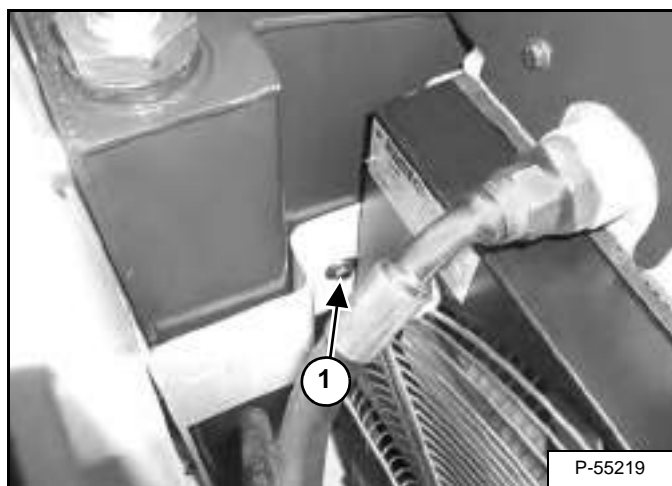

Figure 20-150-8



Remove the two tank mounting bolts (Item 1) [Figure 20-150-7] & [Figure 20-150-8].

Remove the hydraulic reservoir.

## STEERING VALVE

### Removal And Installation

Remove the dash cover / column cover. (See "Removal And Installation" on page 50-130-1)

Figure 20-160-1

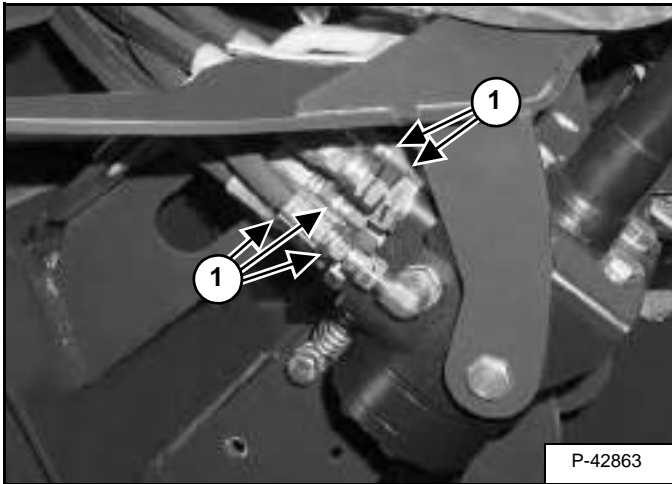

Remove the five hoses (Item 1) [Figure 20-160-1] from the steering valve.

**NOTE:** Mark hoses for correct installation.

## IMPORTANT

When repairing hydrostatic and hydraulic systems, clean the work area before disassembly and keep all parts clean. Always use caps and plugs on hoses, tubelines and ports to keep dirt out. Dirt can quickly damage the system.

I-2003-0888

Figure 20-160-2

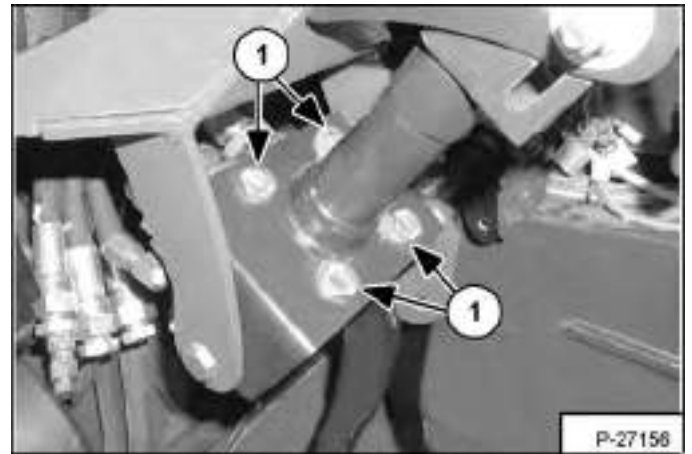

Remove the four bolts (Item 1) [Figure 20-160-2] and remove the steering valve.

## STEERING VALVE (CONT'D)

### Parts Identification

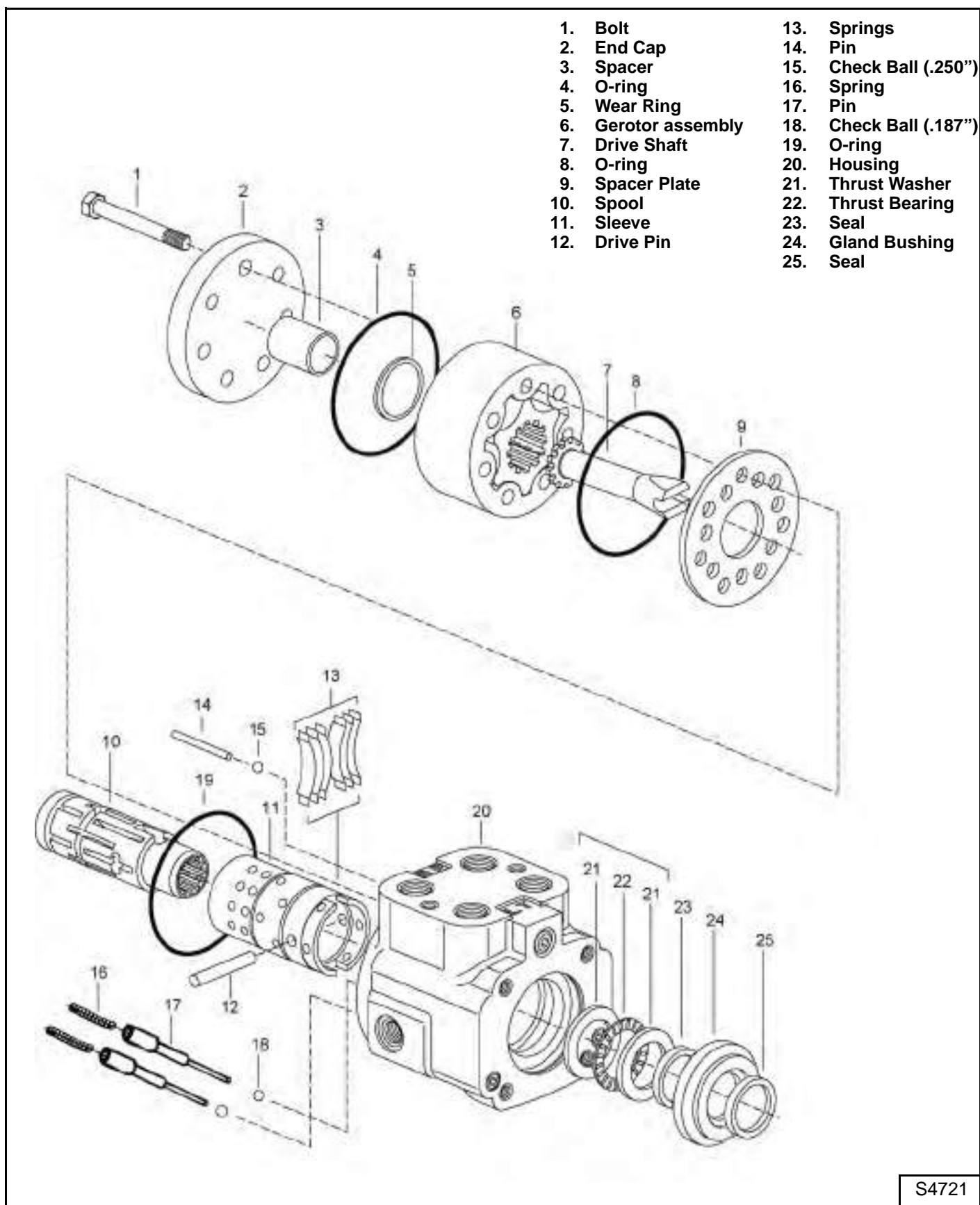

S4721

## STEERING VALVE (CONT'D)

### Disassembly

# IMPORTANT

When repairing hydrostatic and hydraulic systems, clean the work area before disassembly and keep all parts clean. Always use caps and plugs on hoses, tubelines and ports to keep dirt out. Dirt can quickly damage the system.

I-2003-0888

Remove the hydraulic fittings from the steering valve.

Figure 20-160-1



Remove the seven end cap bolts [Figure 20-160-4].

Figure 20-160-2

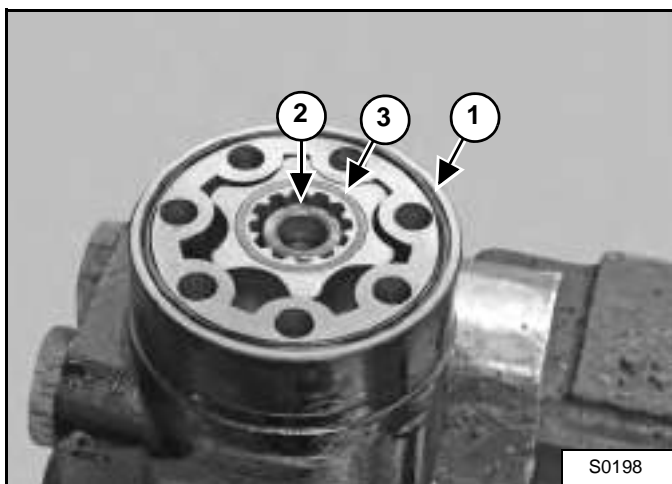

Remove the O-ring (Item 1), spacer (Item 2) and wear ring (Item 3) [Figure 20-160-5].

Figure 20-160-3

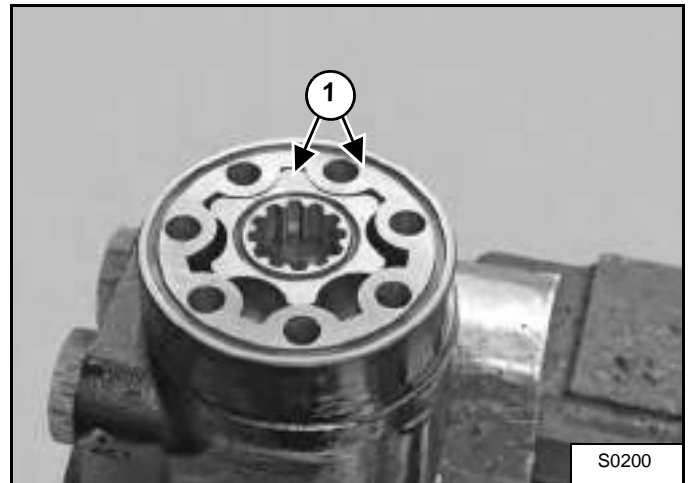

Remove the gerotor assembly (Item 1) [Figure 20-160-6] and the O-ring beneath.

Figure 20-160-4

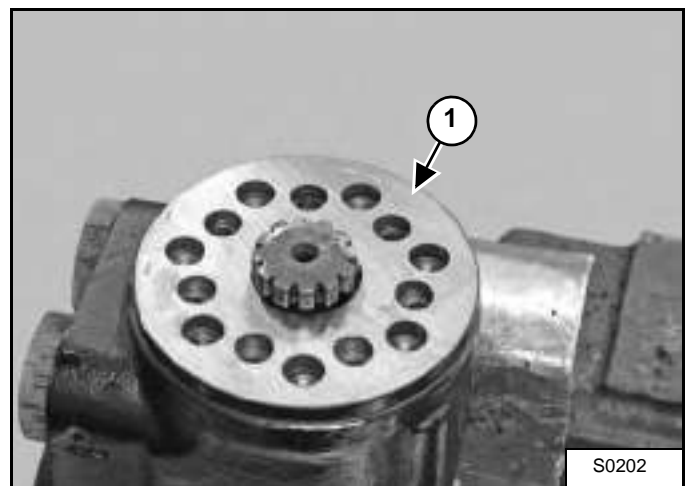

Remove the spacer plate (Item 1) [Figure 20-160-7].

## STEERING VALVE (CONT'D)

### Disassembly (Cont'd)

Figure 20-160-5

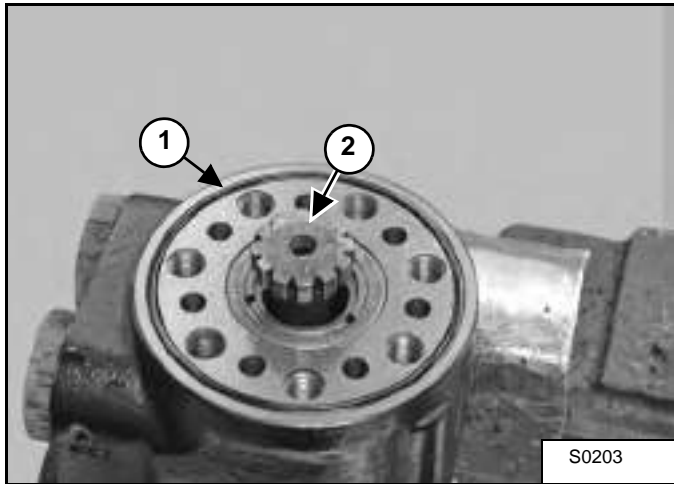

Remove the O-ring (Item 1) [Figure 20-160-8].

Remove the drive shaft (Item 2) [Figure 20-160-8], while holding the steering valve upright.

Figure 20-160-6

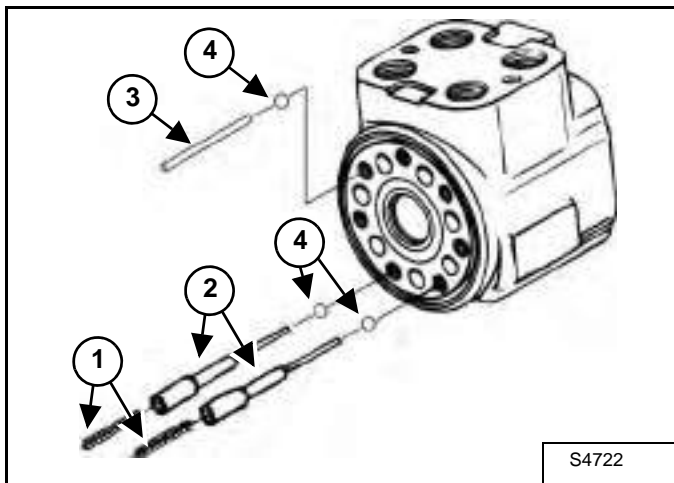

Carefully remove the two springs (Item 1), two pins (Item 2), pin (Item 3) and balls (Item 4) [Figure 20-160-9] from each port.

Figure 20-160-7

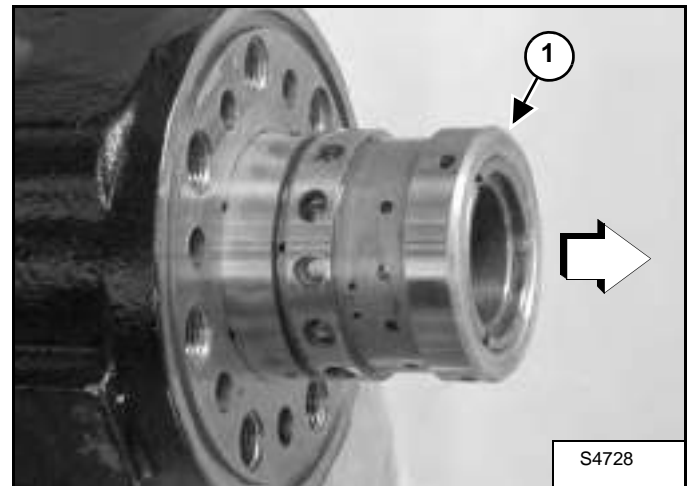

Tip the housing onto the port face and remove the spool and sleeve assembly (Item 1) [Figure 20-160-10].

**NOTE: Do not bind spool and sleeve in housing. Rotate spool and sleeve assembly slowly when removing it from housing.**

Figure 20-160-8

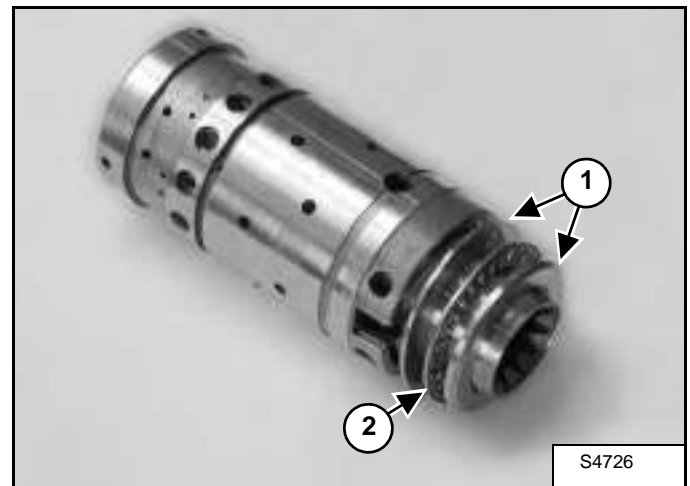

Remove the two bearing washers (Item 1) and thrust bearing (Item 2) [Figure 20-160-11].



## STEERING VALVE (CONT'D)

### Disassembly (Cont'd)

Figure 20-160-9

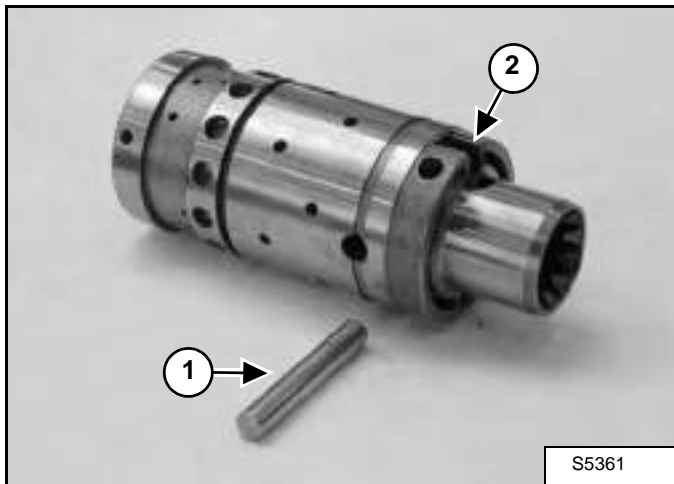

Remove the pin (Item 1), then remove the six springs (Item 2) by partially sliding out the spool. [Figure 20-160-12].

Figure 20-160-10

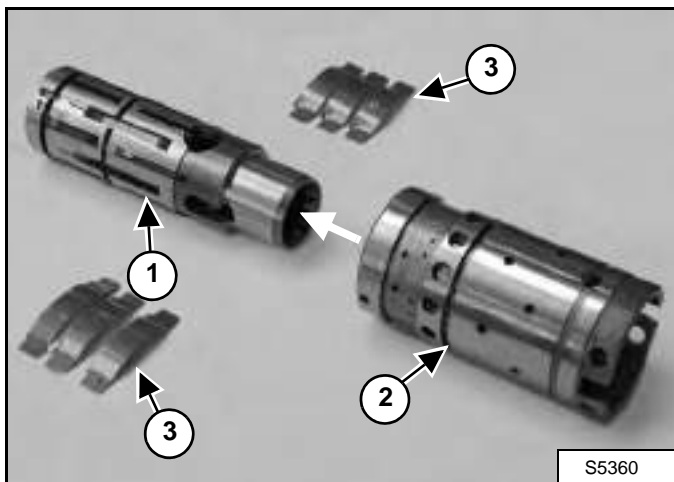

Remove the control spool (Item 1) from the sleeve (Item 2) [Figure 20-160-13].

Check the condition of the six (two sets of three) springs (Item 3) [Figure 20-160-13].

Figure 20-160-11

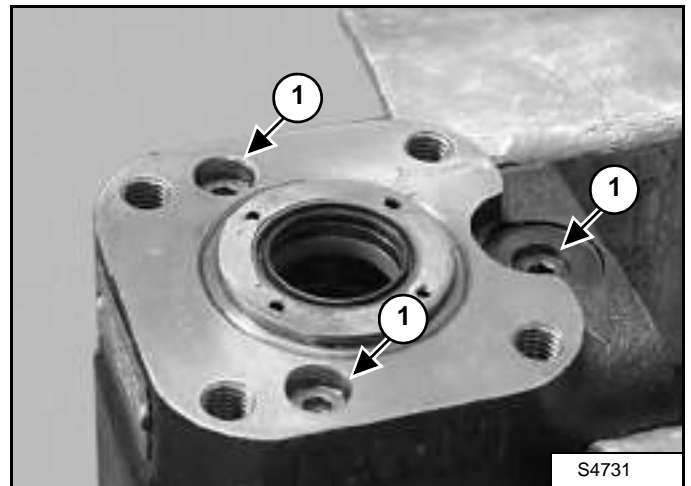

The housing valves (Item 1) [Figure 20-160-14] are factory adjusted and are not to be changed. The housing with specified valve pressure settings, the mating spool and sleeve are not practical replacement parts.

Figure 20-160-12

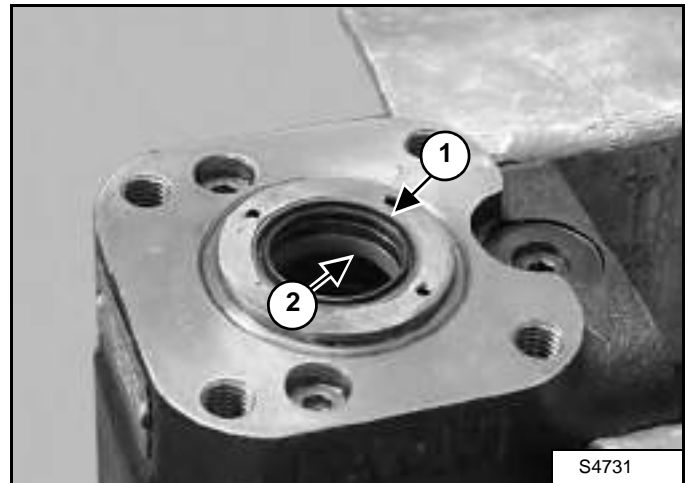

Remove the seals (Items 1 and 2) [Figure 20-160-15] from the gland bushing.

**NOTE:** Gland bushing removal requires a special 4-pin tool. Do not attempt to remove without this tool as damage to the bushing could occur. It is not required to remove the bushing for seal replacement.

## STEERING VALVE (CONT'D)

### Inspection

Figure 20-160-13

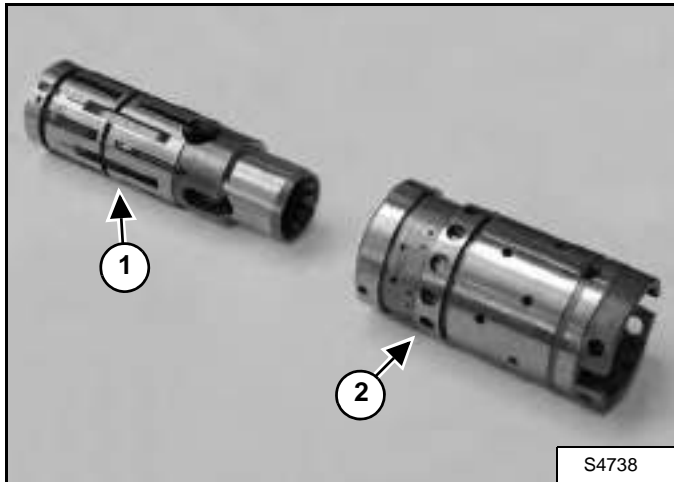

Inspect the spool (Item 1) and sleeve (Item 2) [Figure 20-160-16] for any damage or wear. Replace as needed.

Figure 20-160-14

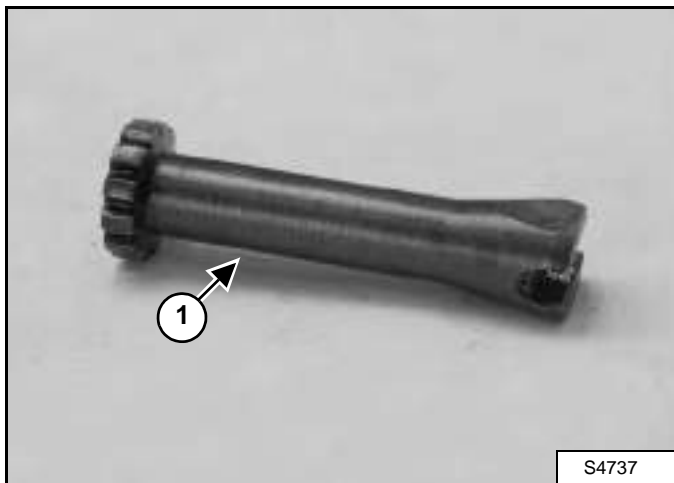

Inspect the drive shaft (Item 1) [Figure 20-160-17] for any damage or wear. Replace as needed.

### Assembly

Figure 20-160-15

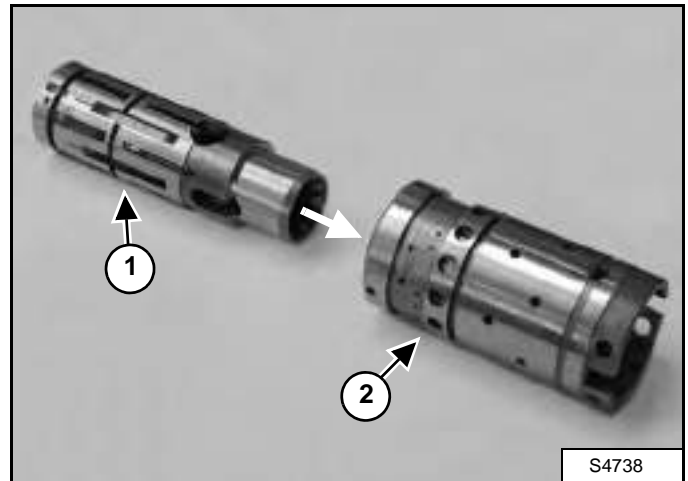

Assemble the spool (Item 1) and sleeve (Item 2) [Figure 20-160-18] carefully so that spring slots line up at the same end. Rotate the spool while sliding parts together.

**NOTE:** Test for free rotation. The spool should rotate smoothly in the sleeve with fingertip force applied at splined end.

Figure 20-160-16

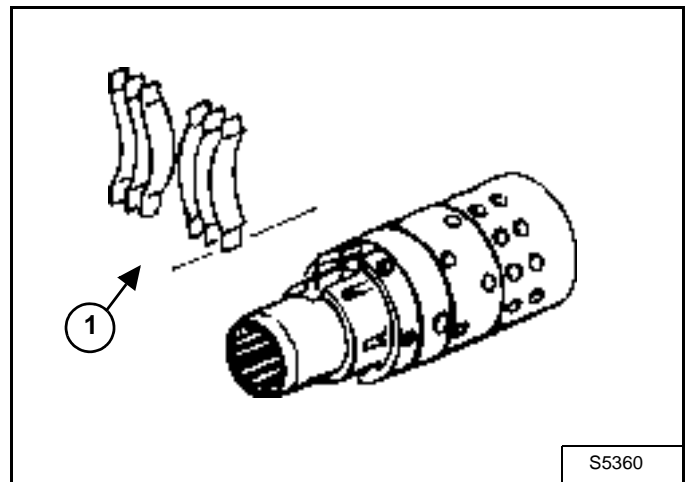

Install the six springs (Item 1) [Figure 20-160-19] onto the spool and sleeve.

Center spring set in spring slots. Seat springs down evenly and flush with upper surface of spool and sleeve.

**NOTE:** There are six springs and should be positioned three per side and back to back.

## STEERING VALVE (CONT'D)

### Assembly (Cont'd)

Figure 20-160-17

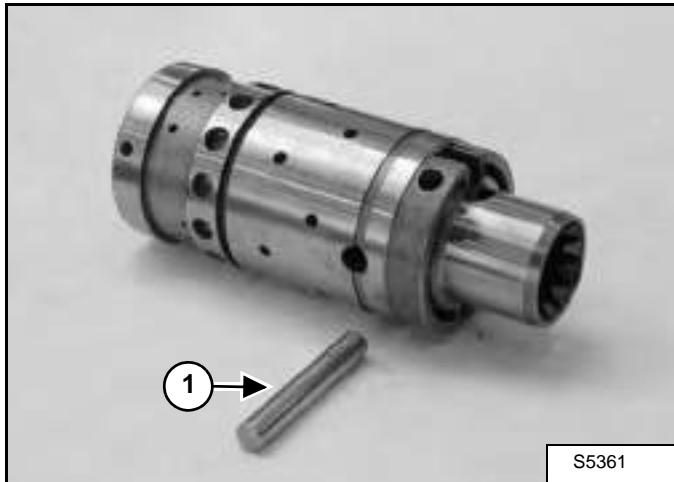

Insert pin (Item 1) [Figure 20-160-20] through the spool and sleeve assembly until the pin is flush at both sides of the sleeve.

Figure 20-160-18

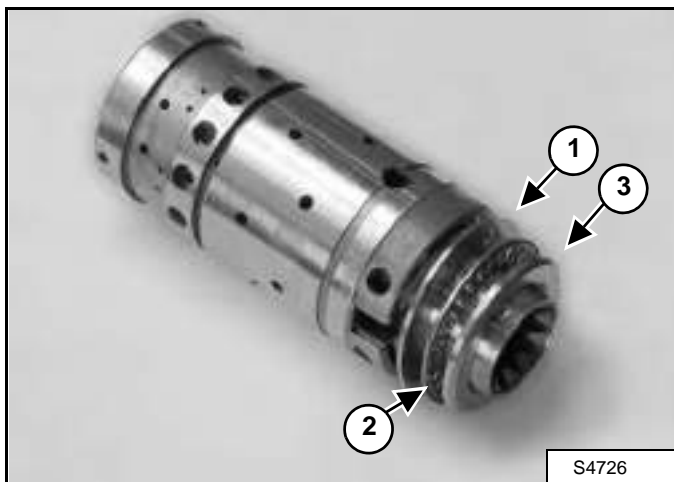

Install the big diameter bearing washer (Item 1) [Figure 20-160-21] with the chamfered side towards the sleeve.

Install the thrust bearing (Item 2) [Figure 20-160-21].

Install the small diameter bearing washer (Item 3) [Figure 20-160-21] with the chamfered side facing the outside of the bearing assembly.

Figure 20-160-19

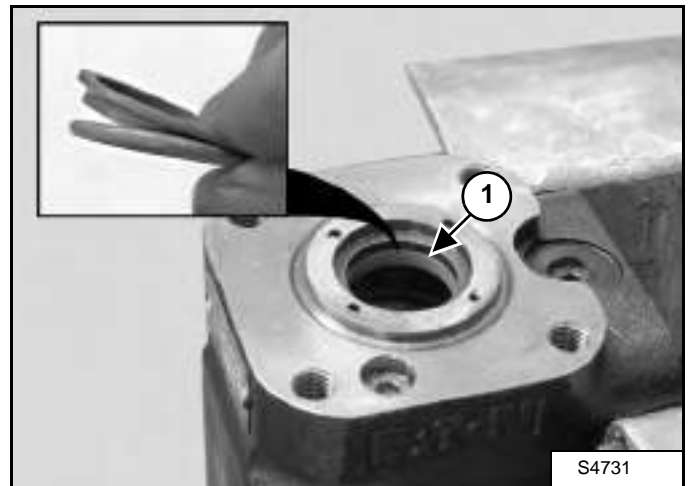

Install the seal (Item 1) [Figure 20-160-22] in the gland bushing, with smooth side of the seal facing towards bushing.

Figure 20-160-20

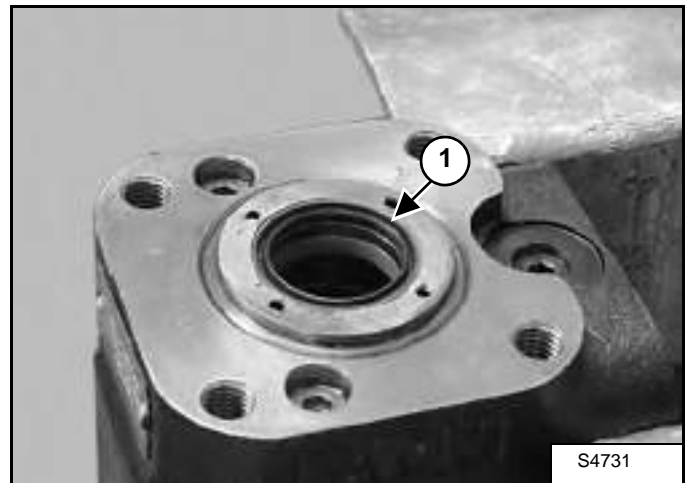

Install the seal (Item 1) [Figure 20-160-23] in the gland bushing.

## STEERING VALVE (CONT'D)

### Assembly (Cont'd)

Figure 20-160-21

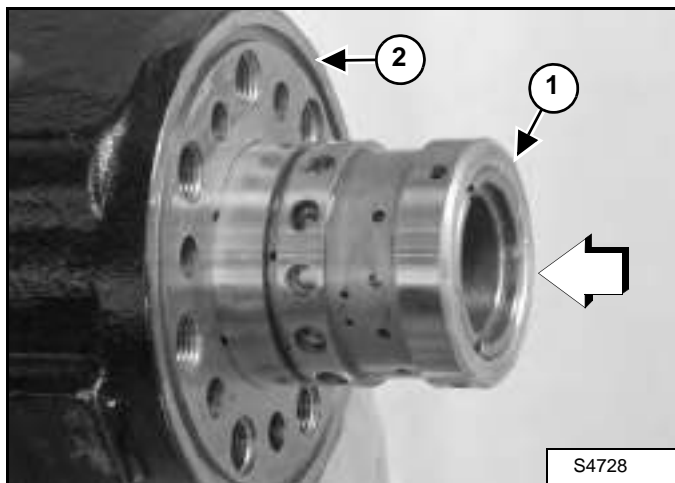

Put some clean oil on the spool and sleeve assembly (Item 1) and fully insert it into the housing (Item 2) [Figure 20-160-24] such that the splined end of the spool enters the housing first. Mind the correct position of the bearing and washers inside the housing.

**NOTE: To prevent the cross pin from dropping into the discharge groove of the housing, do not pull the spool assembly beyond this point. With the spool assembly in this flush position, check for free rotation within housing by turning assembly with fingertip force at the splined end.**

Figure 20-160-22

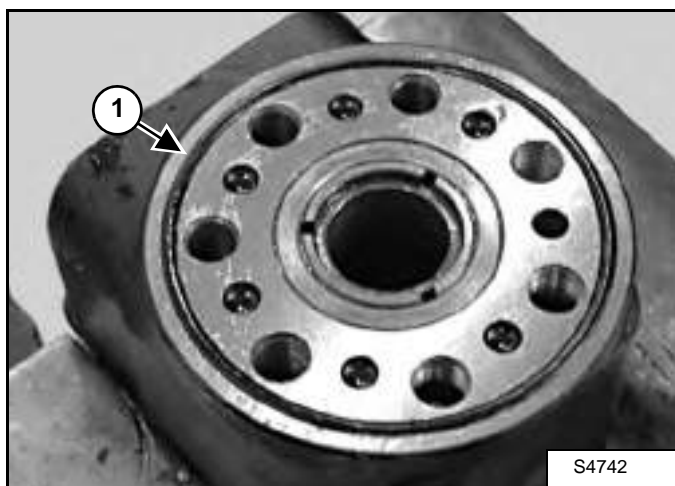

Install the O-ring (Item 1) [Figure 20-160-25] into the housing.

### Assembly (Cont'd)

Figure 20-160-23

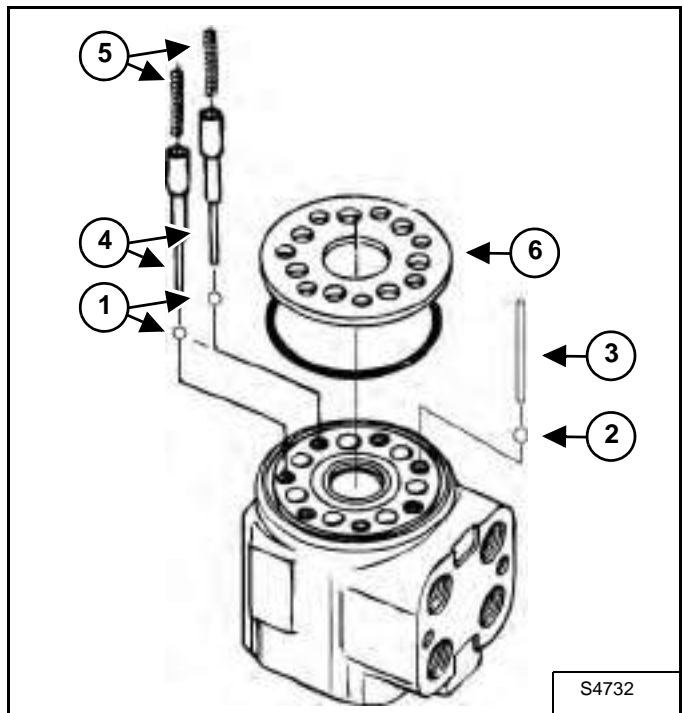

Install the two .187" balls (Item 1), .250" ball (Item 2), pin (Item 3), two pins (Item 4) and springs (Item 5) [Figure 20-160-26] in the holes as shown.

Install the spacer plate (Item 6) [Figure 20-160-26]. Align the bolt holes in the spacer plate with tapped holes in the housing.

Figure 20-160-24

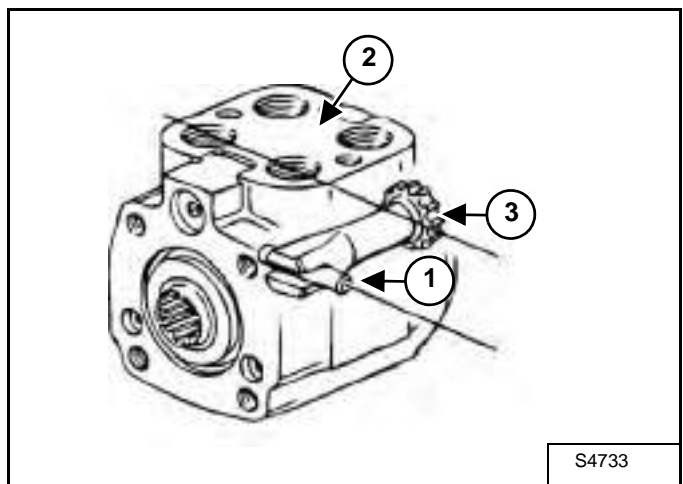

Rotate the spool and sleeve assembly until the pin (Item 1) is parallel with the port face (Item 2) [Figure 20-160-27].

Install the drive (Item 3) [Figure 20-160-27] making sure the drive is engaged with the pin.

Mark the drive according to the parallel line.

## STEERING VALVE (CONT'D)

### Assembly (Cont'd)

Figure 20-160-25

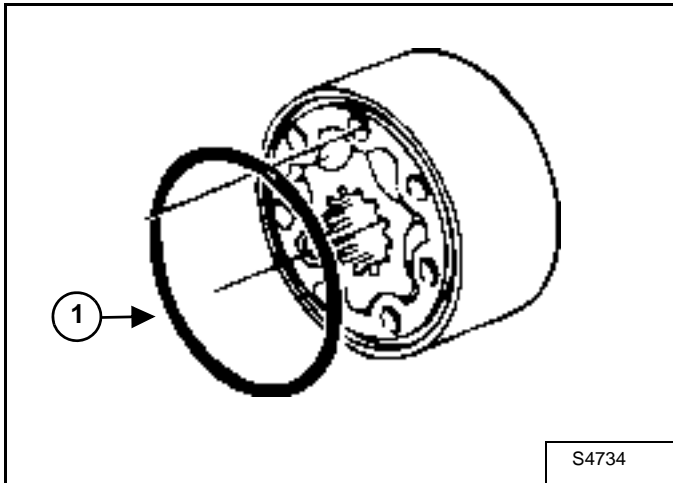

Install the O-ring (Item 1) [Figure 20-160-28] in the gerotor (on the spacer plate side).

Figure 20-160-26

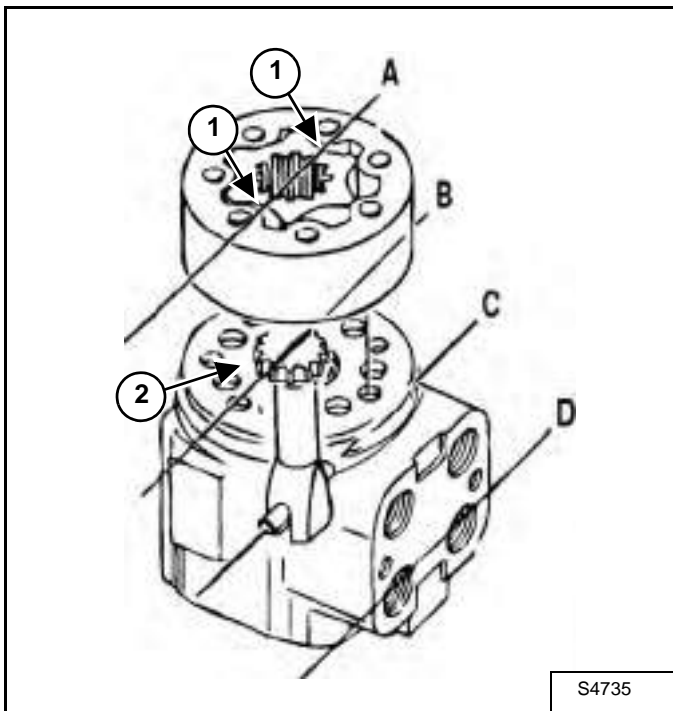

Align the star valleys (Items 1) (Reference A) to the marked drive (Item 2) (Reference B) [Figure 20-160-29]. This way the valleys are aligned with the pin.

**NOTE:** Keep in mind the parallel relationship of reference lines A, B, C, and D in [Figure 20-160-29].

Figure 20-160-27

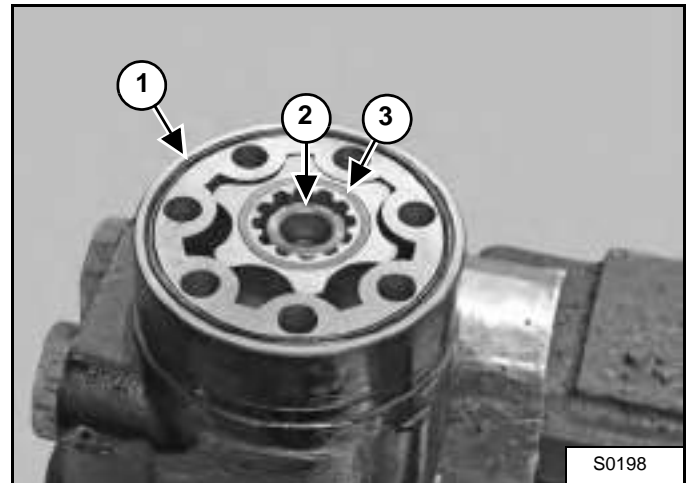

Install the O-ring (Item 1), spacer (Item 2) and wear ring (Item 3) [Figure 20-160-30].

Figure 20-160-28



Install the seven end cap bolts [Figure 20-160-31]. Pretighten to 12.5 ft.-lb. (17 N•m), then torque screws to 19-22 in.-lb.(26-30 N•m).



**Bobcat®**

## HYDRAULIC CONTROL VALVE

### Checking Drain Pressure

Figure 20-170-1

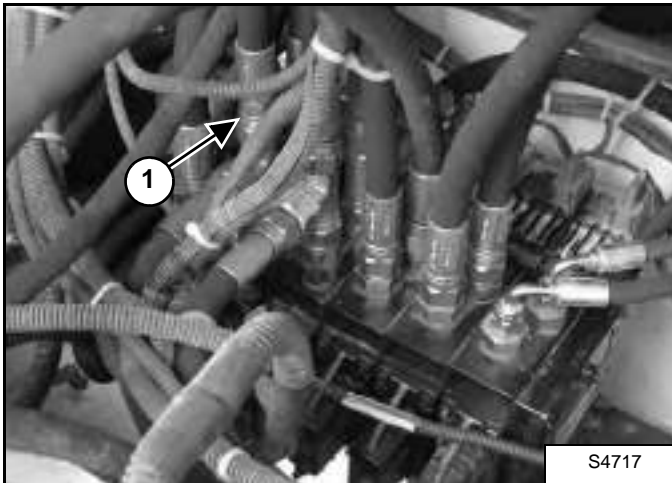

1. Remove the hose (Item 1) [Figure 20-170-1] from the inlet section of the control valve and install a tee fitting.

Figure 20-170-2



2. Install a 500 PSI (35 bar) gauge on the tee fitting [Figure 20-170-2].
3. Start the engine, lower the restraint bar (if equipped) and run the engine at 2200 RPM. Record the pressure. The pressure at the gauge should be 22 PSI (1,5 bar) maximum.
4. Remove the gauge.

### Valve Section Troubleshooting (Auxiliary Section Example)

**NOTE:** This procedure is the same for all the valve sections and should be performed for every valve section. As an example the Auxiliary Valve Troubleshooting is described. See below [Figure 20-170-3] for an overview of the section functions.

Figure 20-170-3

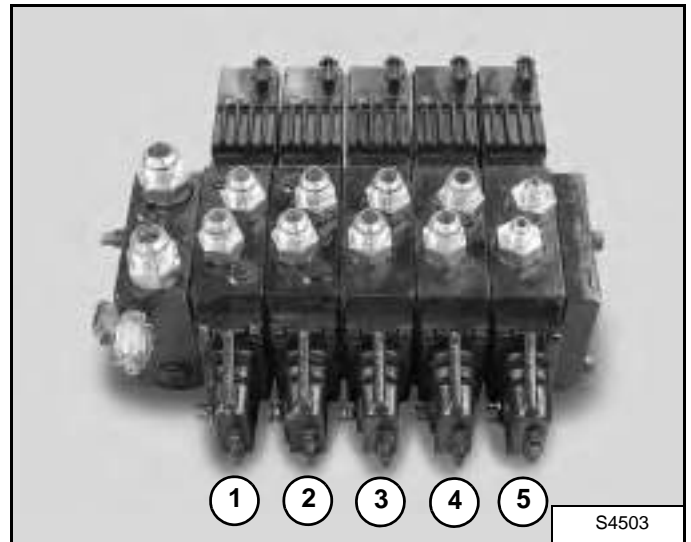

Lifting Valve Section (Item 1), Tilting Valve Section (Item 2), Telescoping Valve Section (Item 3), Auxiliary Valve Section (Item 4), Frame Leveling Valve Section (Item 5), [Figure 20-170-3].

Record the serial number of the machine, control valve and control module.

The following procedure must be done with the control valve in the machine.

With the engine OFF, the key switch in the run position, move the joystick handle to relieve any hydraulic pressure.

Remove the rear cover from machine.

Figure 20-170-4



Figure 20-170-6

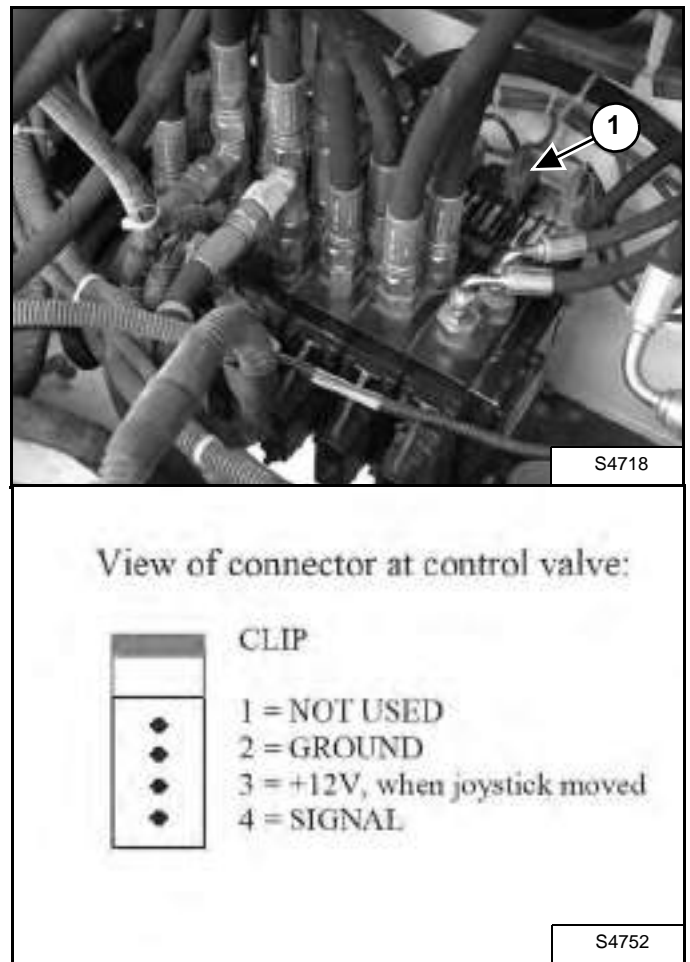

The hydraulic control function switch (Item 1) must be ON (light is on) for all testing procedures and the front auxiliary hydraulics ON / OFF switch (Item 2) [Figure 20-170-4] must be on (top position) (only for auxiliary valve troubleshooting procedure).

1. With the engine OFF, the key in the run position, check that the battery voltage (PIN 3: +12V) on the controller connector (Item 1) [Figure 20-170-6] is at least 12 volts or higher.

Figure 20-170-5

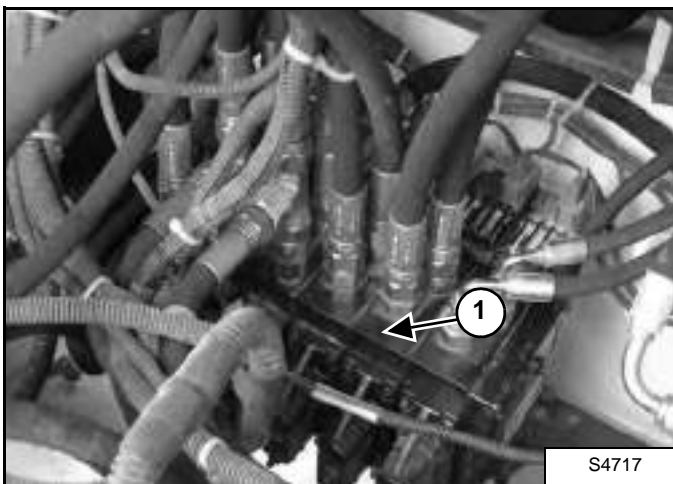



## HYDRAULIC CONTROL VALVE (CONT'D)

### Valve Section Troubleshooting (Auxiliary Section Example) (Cont'd)

Figure 20-170-7

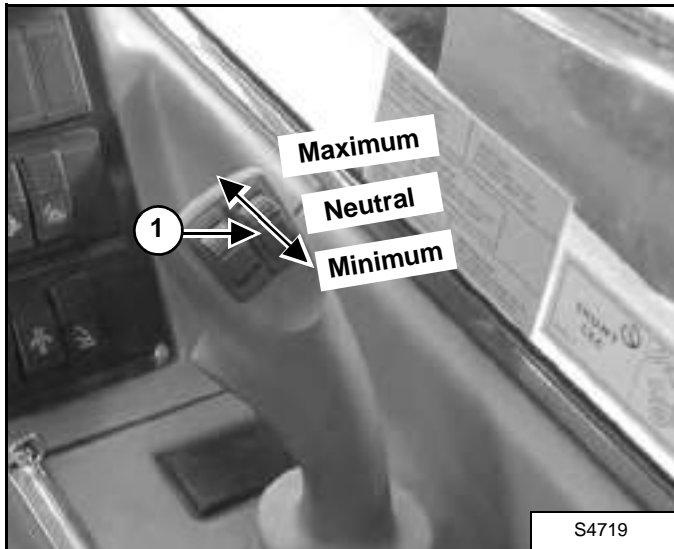

2. With the auxiliary function switch (Item 1) [Figure 20-170-7] in the minimum (back) position check that the SIGNAL voltage on the controller connector (Item 1) [Figure 20-170-6] is 3 volts. If the voltage drops below 3 volts the controller will interpret this as a failure.
3. With the auxiliary function switch (Item 1) [Figure 20-170-7] in the neutral (middle) position check that the SIGNAL voltage on the controller connector (Item 1) [Figure 20-170-6] is 6 volts.
4. With the auxiliary function switch (Item 1) [Figure 20-170-7] in the maximum (forward) position check that the SIGNAL voltage on the controller connector (Item 1) [Figure 20-170-6] is 9 volts.

If one of the three voltage readings in Steps 2, 3 and 4 is not correct, replace the joystick handle (See "Removal And Installation" on page 60-180-1.)

If all voltage readings in Steps 2, 3 and 4 are correct go to step 7.

Perform the following procedure to make sure the required pressures are present:

See "Checking Drain Pressure" on page 20-170-1.

Figure 20-170-8

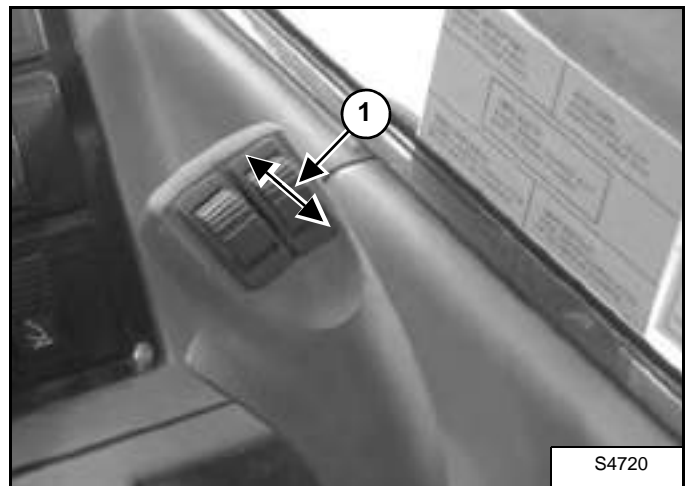

5. With adequate room in front of the machine, start the engine, lower the restraint bar (if equipped) and run the engine at 2200 RPM. Move the auxiliary control switch (Item 1) [Figure 20-170-8] forward and back to see if this function works. Stop the engine.

Figure 20-170-9



6. If the auxiliary function does not work with the engine running, unplug the controller connector (Item 1) [Figure 20-170-9] and plug it back in.

## HYDRAULIC CONTROL VALVE (CONT'D)

### Valve Section Troubleshooting (Auxiliary Section Example) (Cont'd)

Figure 20-170-10

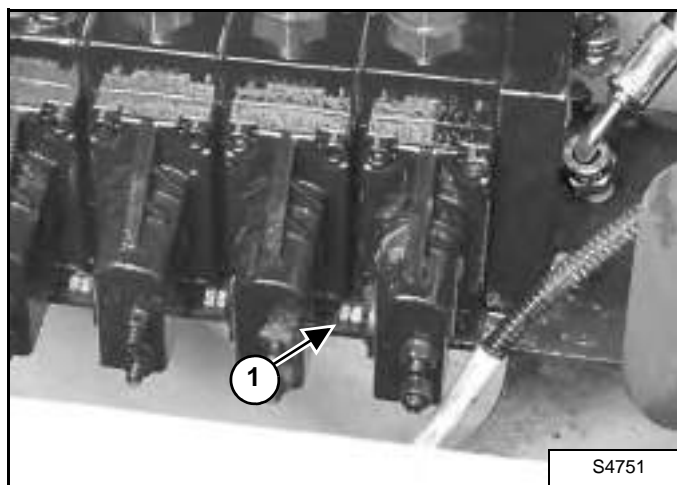

7. If the auxiliary function does not work, operate the spool manually by using a key to rotate the hexagonal axle (Item 1) [Figure 20-170-10].
8. Start the engine, lower the restraint bar (if equipped) and run the engine at 2200 RPM.
9. Manually push and pull the spool to test the movement of the auxiliary function in both directions.

**NOTE:** If by manually operating the spool the auxiliary function is working, the controller must be replaced.

## Removal And Installation

Relieve hydraulic pressure. Drain the hydraulic reservoir. (See "Replacing Hydraulic Fluid" on page 10-100-2.)

## **WARNING**

Hydraulic fluid escaping under pressure can have sufficient force to enter a person's body by penetrating the skin. This can cause serious injury and possible death if proper medical treatment by a physician familiar with this injury is not received immediately.

W-2145-0290

## **IMPORTANT**

When repairing hydrostatic and hydraulic systems, clean the work area before disassembly and keep all parts clean. Always use caps and plugs on hoses, tubelines and ports to keep dirt out. Dirt can quickly damage the system.

I-2003-0888

Figure 20-170-11

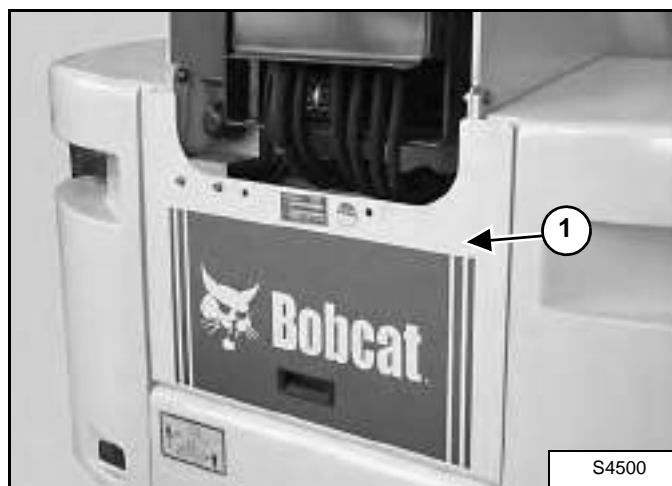

Remove the rear cover (Item 1) [Figure 20-170-11].

## HYDRAULIC CONTROL VALVE (CONT'D)

### Removal And Installation (Cont'd)

Figure 20-170-12

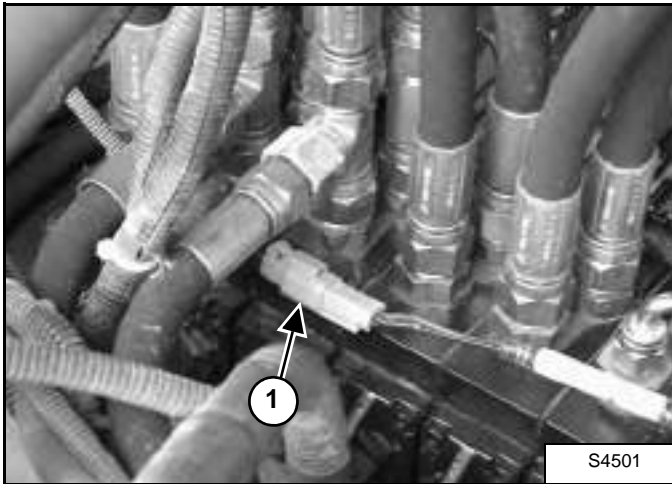

Unplug the wire connector (Item 1) [Figure 20-170-12].

Figure 20-170-13

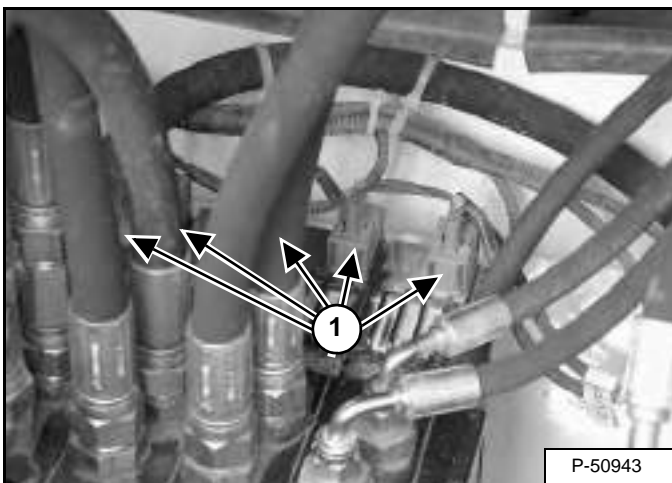

Note down the position of the five electrical connectors (Item 1) [Figure 20-170-13] (each wire is marked with a unique code) and unplug them.

**NOTE: Mark all hoses and tubelines for correct installation.**

Mark and remove the 14 hoses from the hydraulic control valve.

Figure 20-170-14

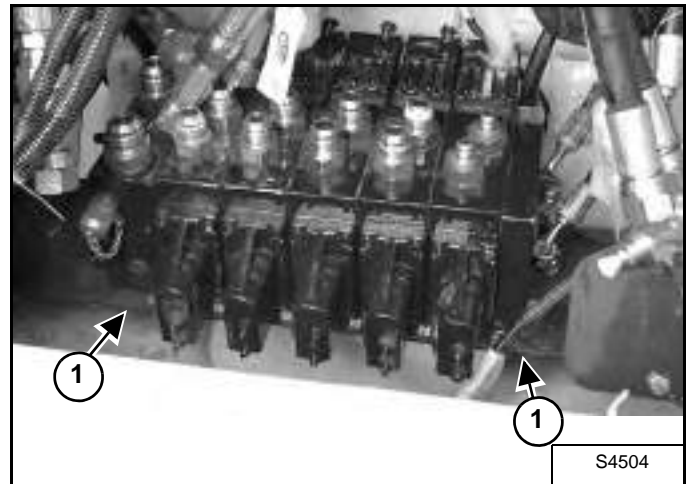

Remove the four bolts (Item 1) [Figure 20-170-14] by which the hydraulic control valve is mounted to its support frame.

Figure 20-170-15

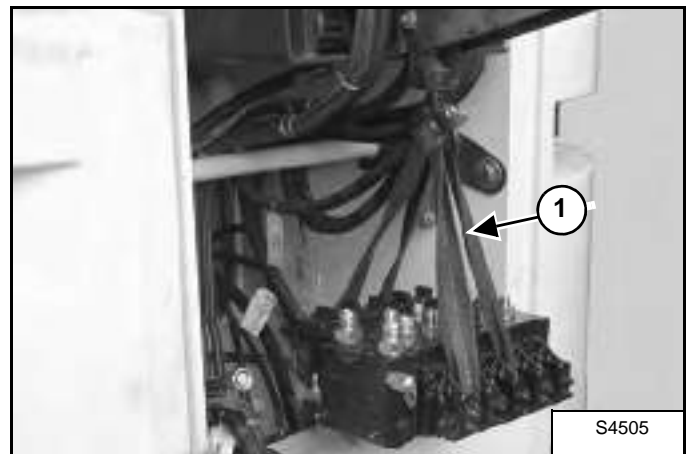

Install a hoist and lifting strap (Item 1) [Figure 20-170-15] on the control valve and remove it from the machine.

## HYDRAULIC CONTROL VALVE (CONT'D)

### Parts Identification

- |                  |                     |               |
|------------------|---------------------|---------------|
| 1. Control Valve | 13. Hose            | 25. Adapter   |
| 2. Support       | 14. Adapter         | 26. Hose      |
| 3. Washer        | 15. Hose            | 27. Block     |
| 4. Screw         | 16. Elbow           | 28. Valve     |
| 5. Nut           | 17. Adapter         | 29. Seals Kit |
| 6. Washer        | 18. Hose            | 30. Coil      |
| 7. Screw         | 19. Pressure Switch | 31. Nut       |
| 8. Screw         | 20. Adapter         |               |
| 9. Valve         | 21. Hose            |               |
| 10. Washer       | 22. Adapter         |               |
| 11. Nut          | 23. T-union         |               |
| 12. Elbow        | 24. Reducer         |               |

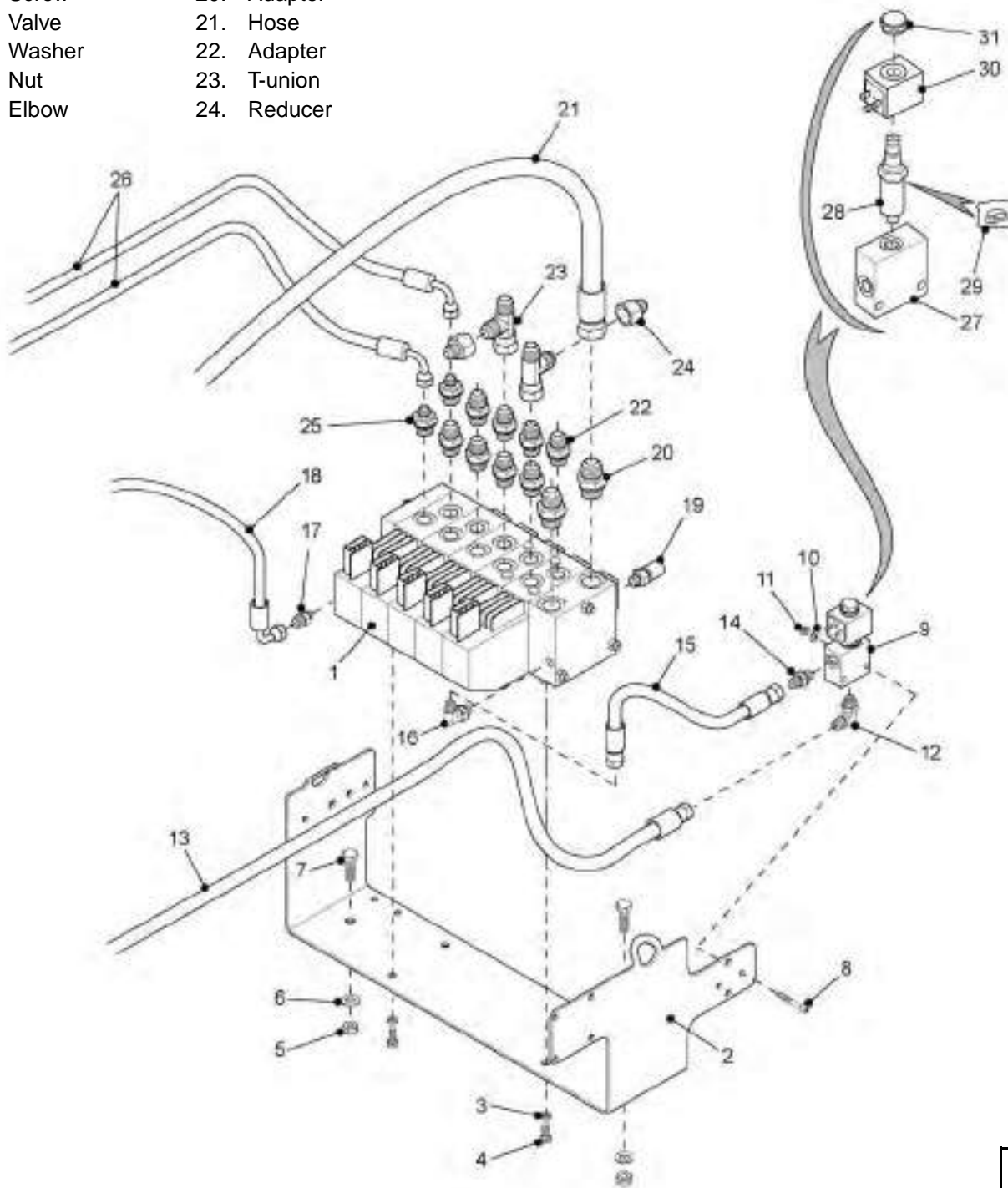

S4710

## HYDRAULIC CONTROL VALVE (CONT'D)

### Parts Identification (Cont'd)

1. Control Valve
2. Lifting Element
3. Tilting Element
4. Telescope Element
5. Auxiliary Hydraulics Element
6. Frame Levelling Element
7. End Plate
8. Pressure Switch
9. Seal Kit
10. End Plate
11. Tie Rod Set
12. Washer
13. Bolt

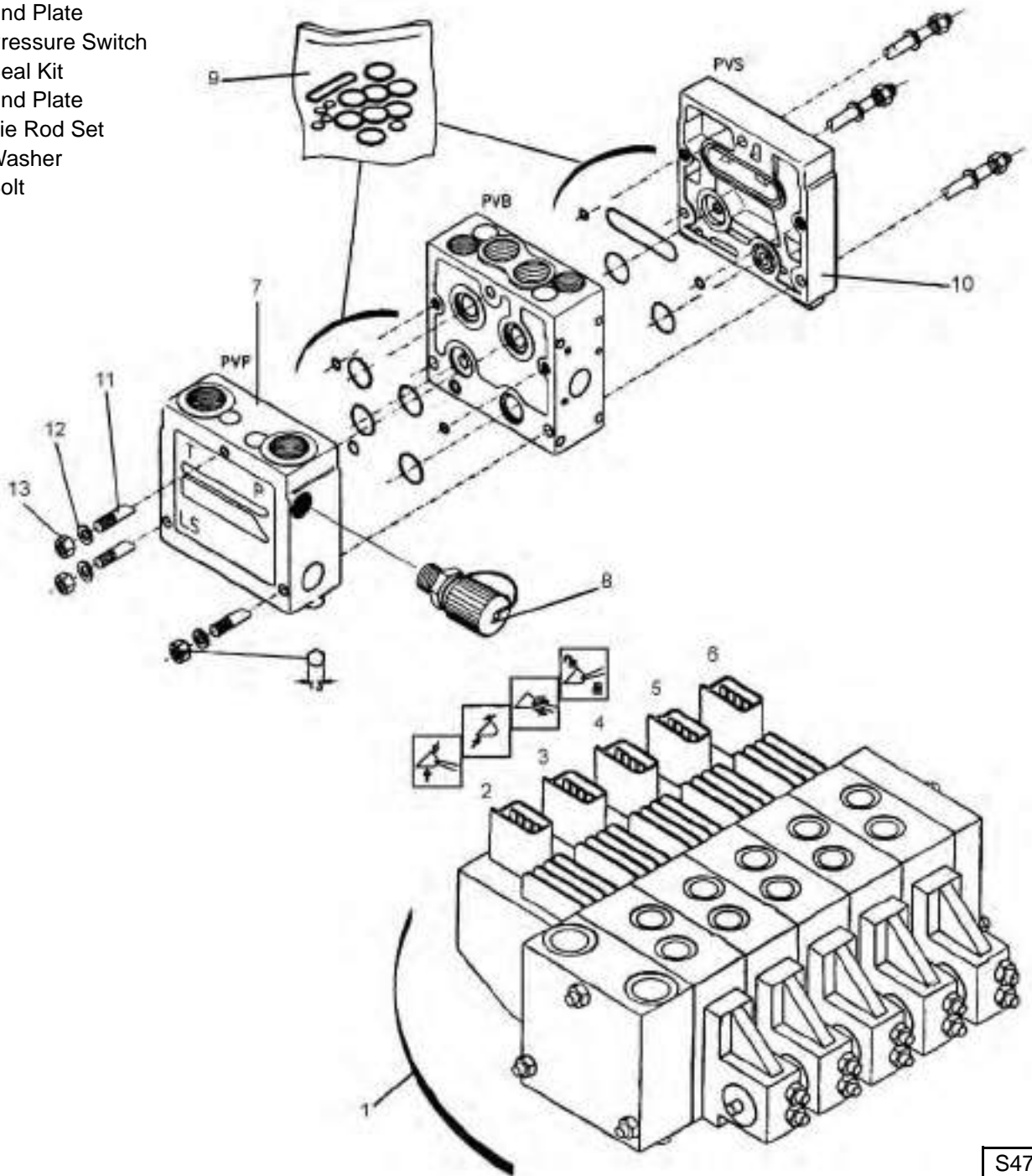

S4711

## HYDRAULIC CONTROL VALVE (CONT'D)

### Parts Identification (Cont'd)

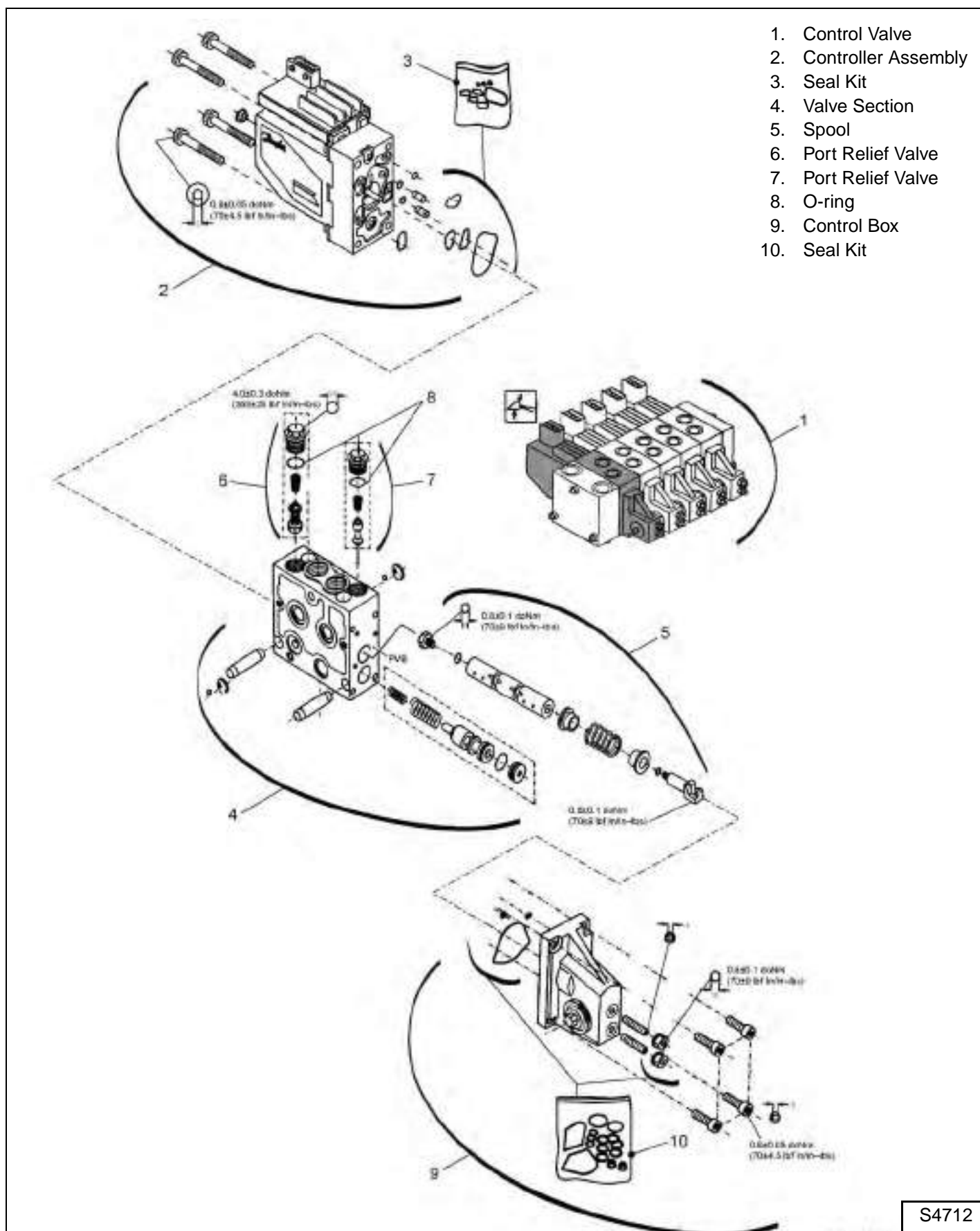

S4712

# HYDRAULIC CONTROL VALVE (CONT'D)

## Parts Identification (Cont'd)

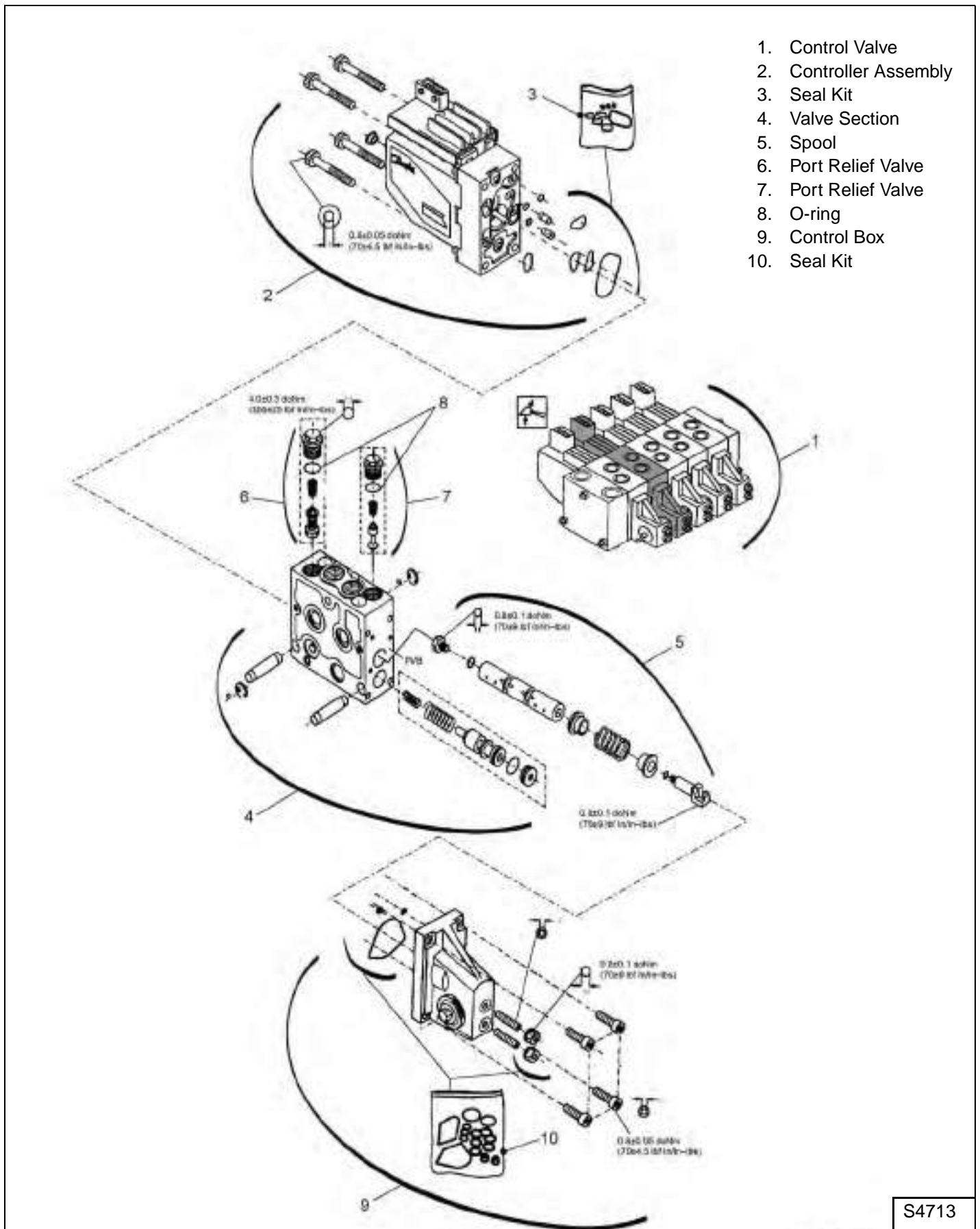

S4713

## HYDRAULIC CONTROL VALVE (CONT'D)

### Parts Identification (Cont'd)

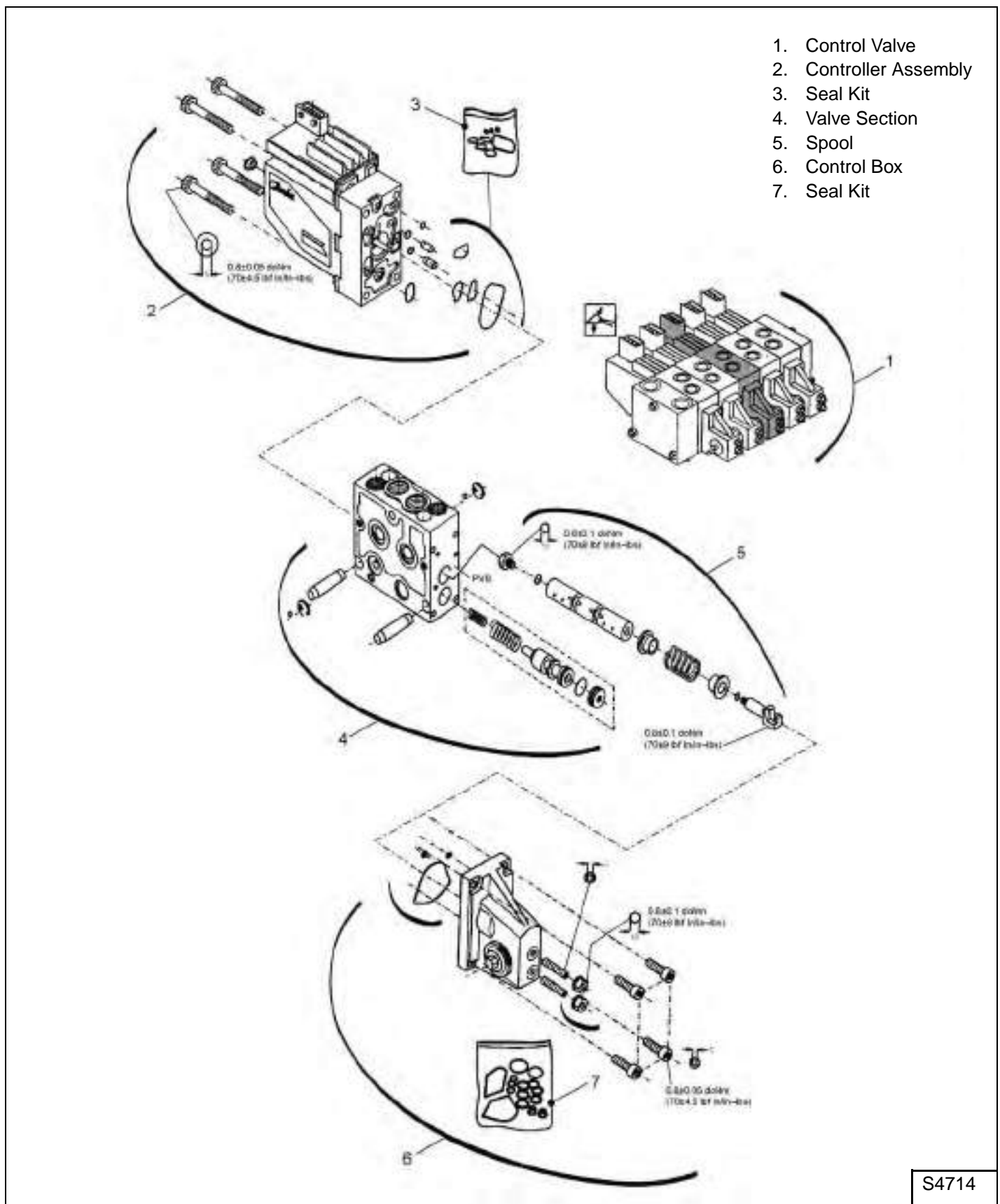

S4714





# HYDRAULIC CONTROL VALVE (CONT'D)

## Parts Identification (Cont'd)

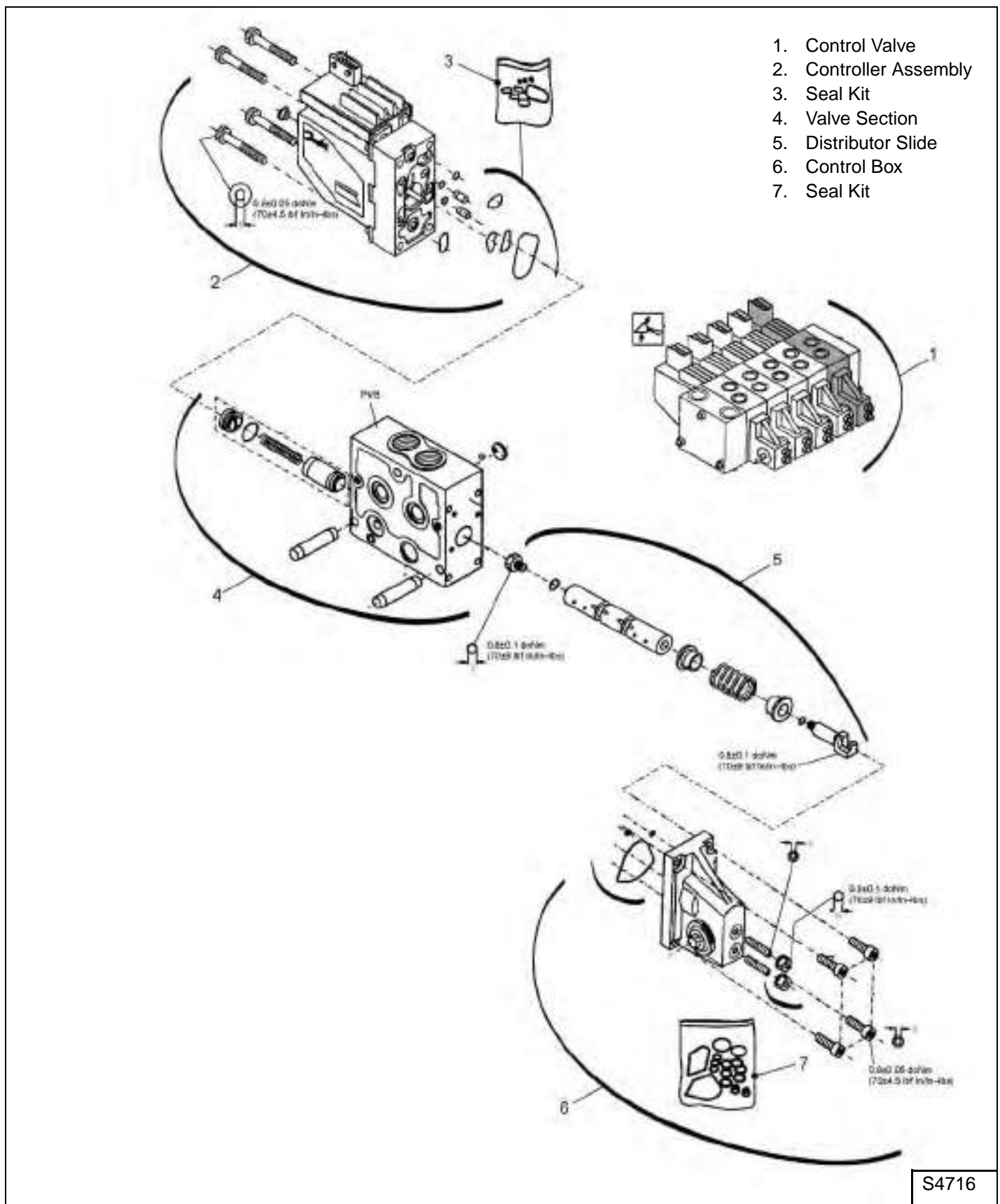

S4716

## HYDRAULIC CONTROL VALVE (CONT'D)

### Section Removal

# IMPORTANT

When repairing hydrostatic and hydraulic systems, clean the work area before disassembly and keep all parts clean. Always use caps and plugs on hoses, tubelines and ports to keep dirt out. Dirt can quickly damage the system.

I-2003-0888

Figure 20-170-16

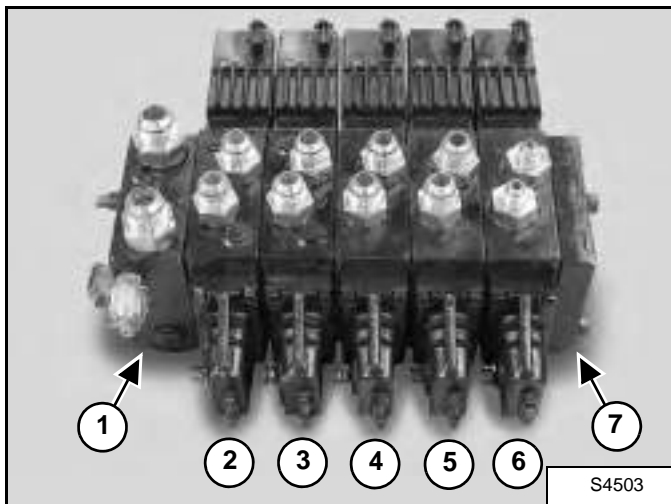

Mark the valve sections for ease of assembly: Inlet/Outlet Valve Section (Item 1), Lifting Valve Section (Item 2), Tilting Valve Section (Item 3), Telescoping Valve Section (Item 4), Auxiliary Valve Section (Item 5), Frame Leveling Valve Section (Item 6), and End Housing Valve Section (Item 7) [Figure 20-170-16].

Figure 20-170-17

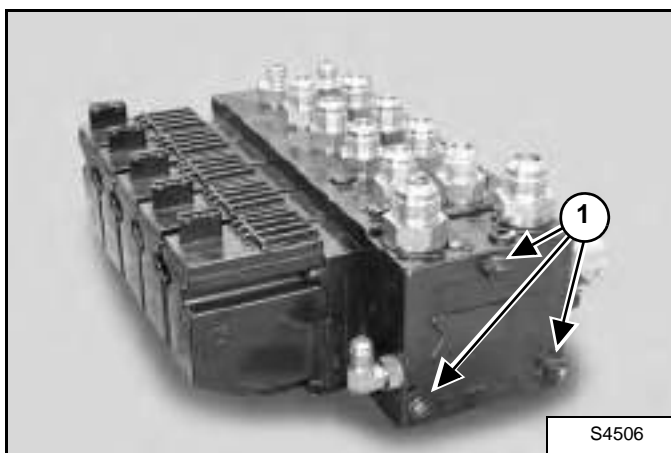

Unscrew the three nuts (Item 1) [Figure 20-170-17] from the tie rod bolts and remove the bolts.

**Assembly:** Tighten the nuts to 26 ft.-lbs. (35 N•m) torque.

## Section Disassembly And Assembly

### Control Box

Figure 20-170-18

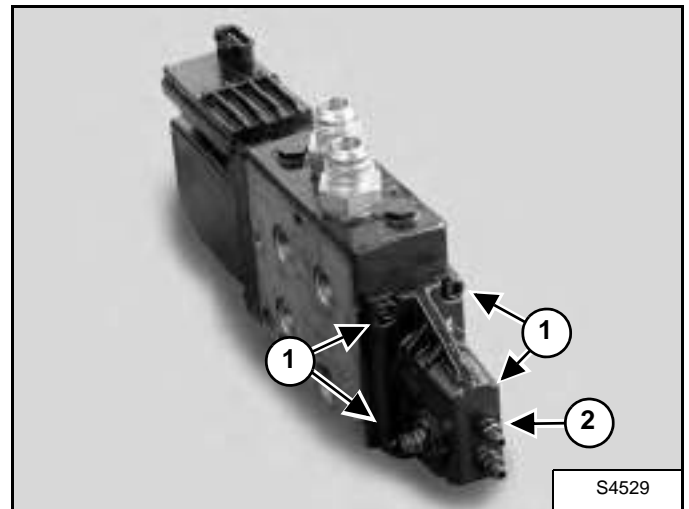

Loosen the four screws (Item 1) and remove the control box (Item 2) [Figure 20-170-18].

Figure 20-170-19

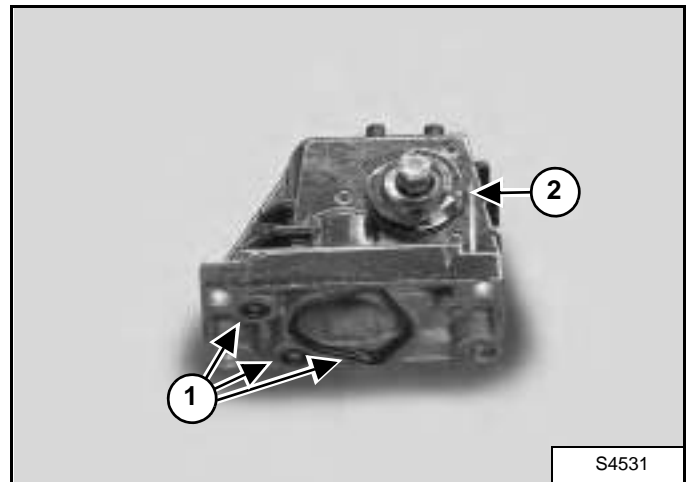

Remove the seals (Item 1). Remove the plug (Item 2) [Figure 20-170-19] from the control box.

## HYDRAULIC CONTROL VALVE (CONT'D)

### Section Disassembly And Assembly (Cont'd)

Control Box (Cont'd)

Figure 20-170-20

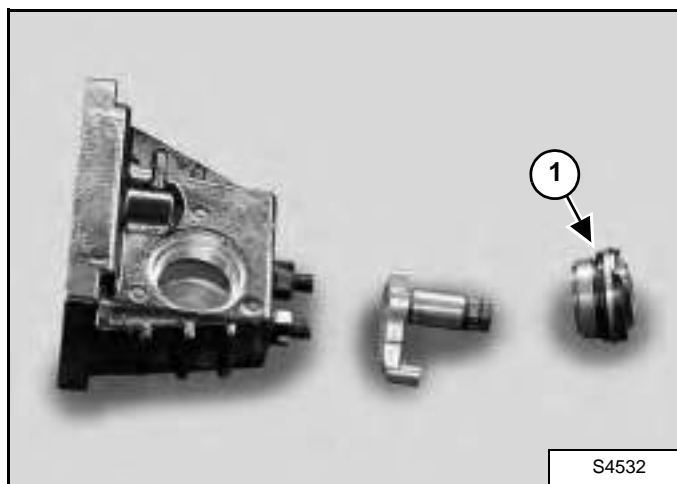

Remove the O-ring (Item 1) [Figure 20-170-20] from the plug.

Controller Assembly

Figure 20-170-21

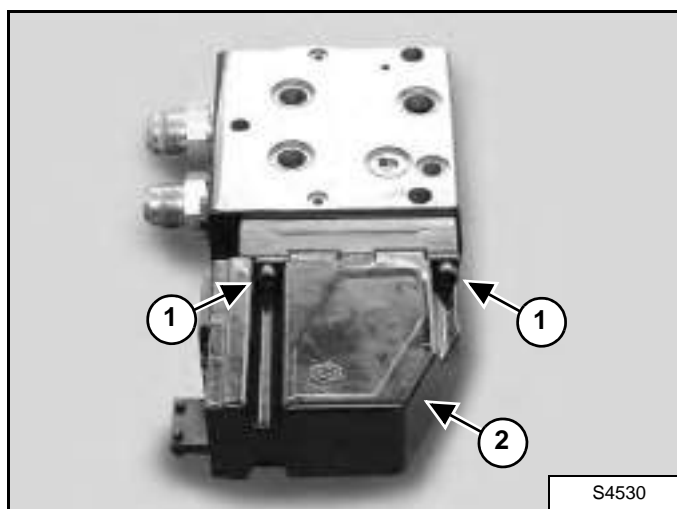

Loosen the four screws (Item 1) (two visible, two on the other side) and remove the controller assembly from the section valve (Item 2) [Figure 20-170-21].

Figure 20-170-22

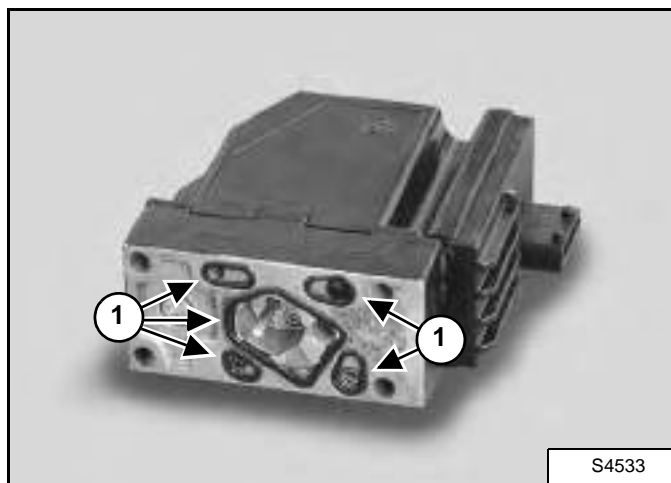

Remove the five O-rings (Item 1) [Figure 20-170-22] from the controller assembly.

Figure 20-170-23

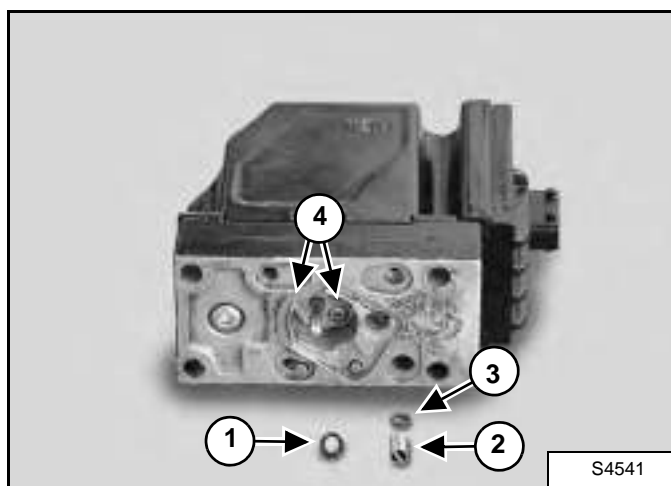

Remove the screen (Item 1), the cylindrical part (Item 2) and ring (Item 3) [Figure 20-170-23] from the controller assembly.

Loosen the two screws (Item 4) [Figure 20-170-23].

## HYDRAULIC CONTROL VALVE (CONT'D)

### Section Disassembly And Assembly (Cont'd)

#### Controller Assembly (Cont'd)

Figure 20-170-24

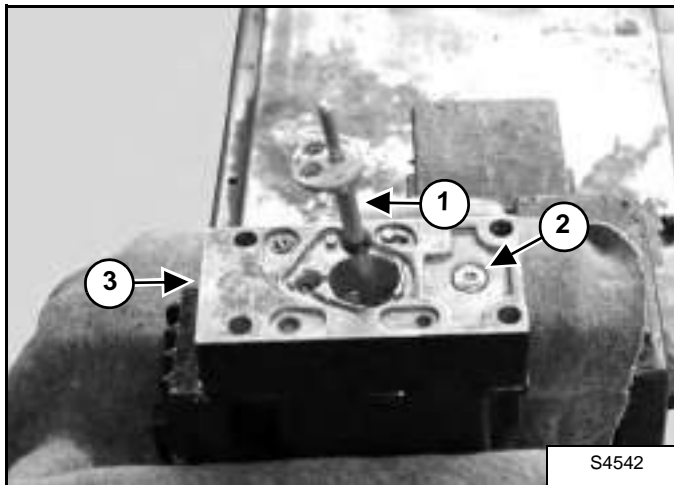

Remove the plunger (Item 1) [Figure 20-170-24] from the controller assembly.

Loosen the screw (Item 2) and remove the cover (Item 3) [Figure 20-170-24] from the controller assembly.

Figure 20-170-25

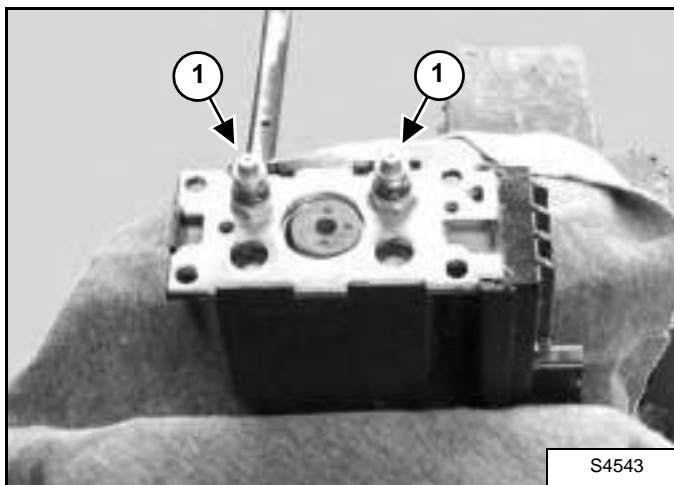

Remove both valve cartridges (Item 1) [Figure 20-170-25].

Figure 20-170-26

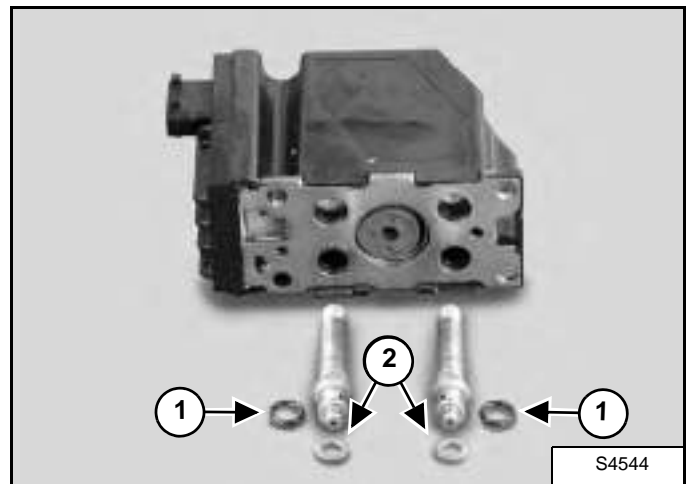

Remove the two O-rings (Item 1) and the two backup rings (Item 2) [Figure 20-170-26].

#### Section Valve

Figure 20-170-27

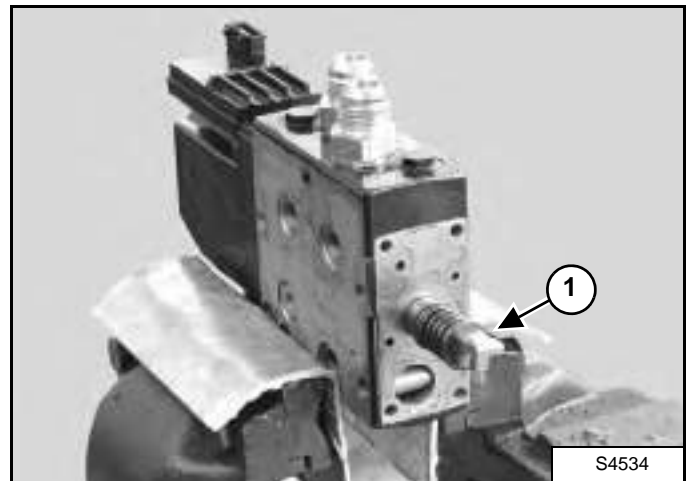

Remove the spool (Item 1) [Figure 20-170-27] from the element.

## HYDRAULIC CONTROL VALVE (CONT'D)

### Section Disassembly And Assembly (Cont'd)

#### Section Valve (Cont'd)

Figure 20-170-28

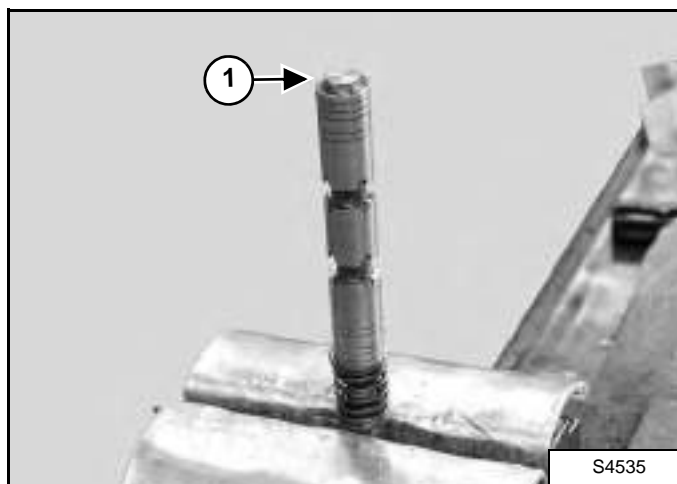

Loosen the screw (Item 1) [Figure 20-170-28] on top of the spool.

Figure 20-170-29

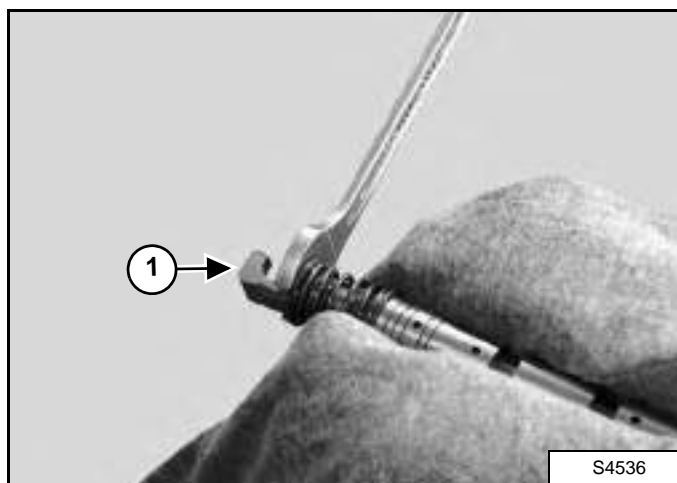

Use a wrench to remove the adapter (Item 1) [Figure 20-170-29] from the spool.

Figure 20-170-30

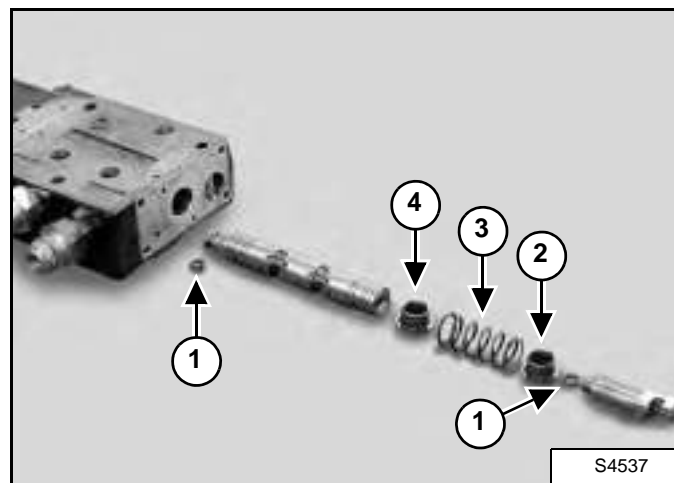

Remove the O-rings (Item 1), the spring retainer (Item 2), the spring (Item 3) and the other spring retainer (Item 4) [Figure 20-170-30] from the spool.

Figure 20-170-31

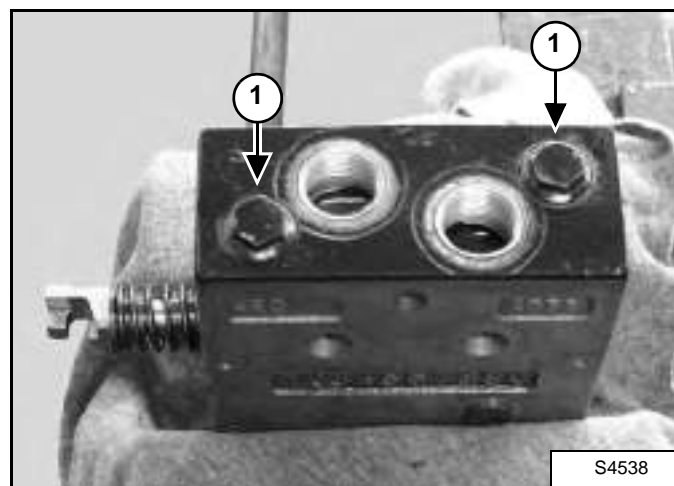

Remove both port relief valve plugs (Item 1) [Figure 20-170-31] from the valve section (lifting and tilting valve sections only).

## HYDRAULIC CONTROL VALVE (CONT'D)

### Section Disassembly And Assembly (Cont'd)

Section Valve (Cont'd)

Figure 20-170-32

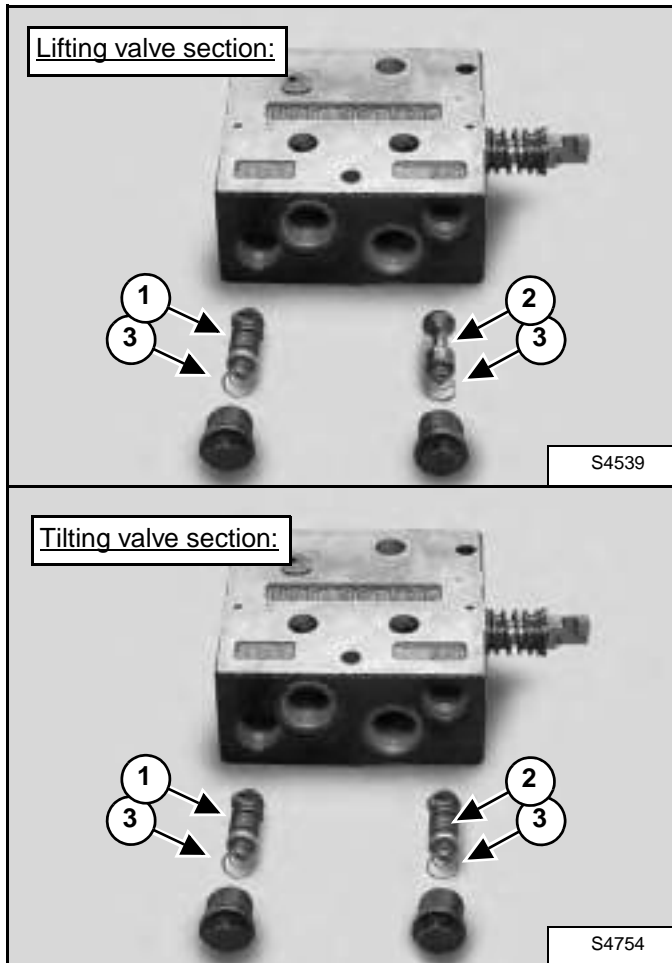

Lifting valve section: Remove the port relief valve (Item 1) and the check valve (Item 2), and their corresponding springs (Items 3) [Figure 20-170-32] from the valve section.

Tilting valve section: Remove both port relief valves (Items 1 & 2), and their corresponding springs (Items 3) [Figure 20-170-32] from the valve section.

### Inlet Section Disassembly And Assembly

Figure 20-170-33

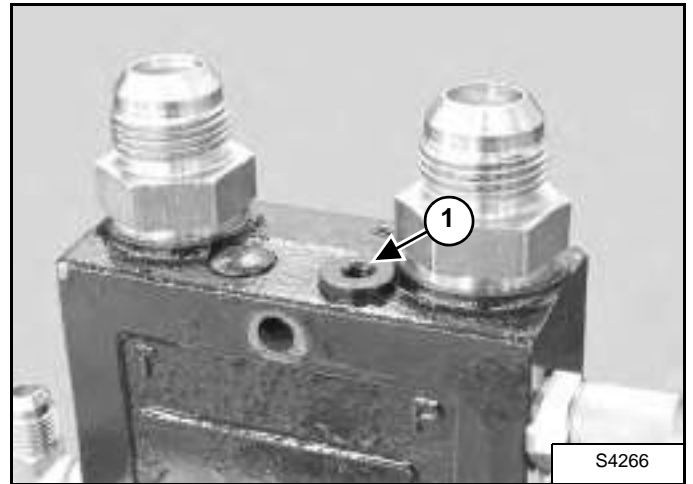

Remove the plug (Item 1) [Figure 20-170-33] from the inlet section.

Figure 20-170-34

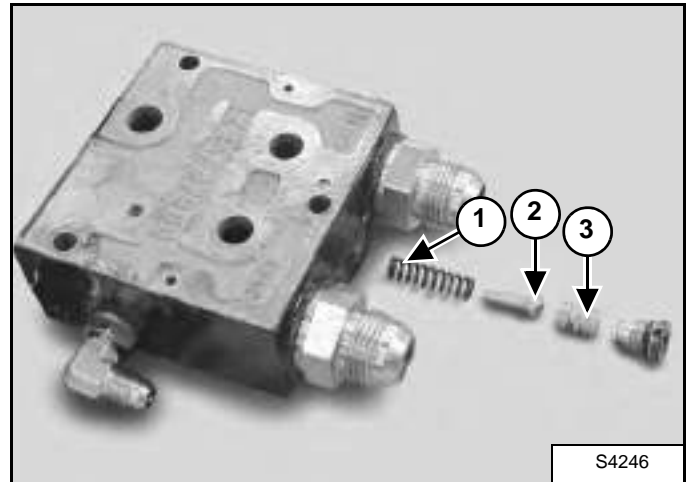

Remove the spring (Item 1), the bolt (Item 2) and the cylinder (Item 3) [Figure 20-170-34] out of the valve block.

## HYDRAULIC CONTROL VALVE (CONT'D)

### Inlet Section Disassembly And Assembly (Cont'd)

Figure 20-170-35

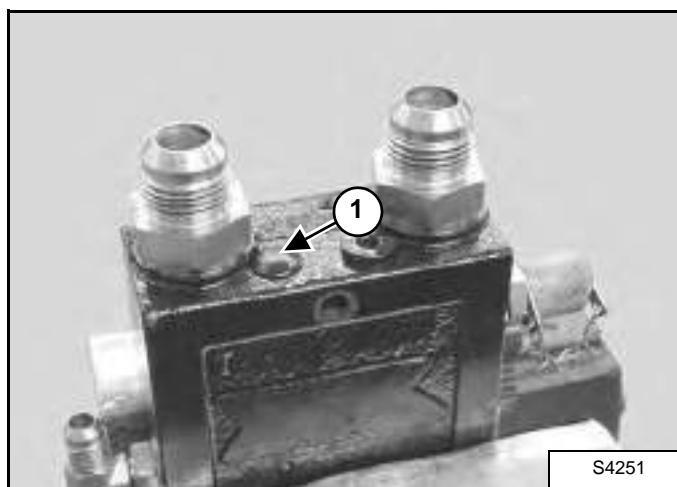

Remove the cap (Item 1) [Figure 20-170-35] from the inlet section.

Figure 20-170-36

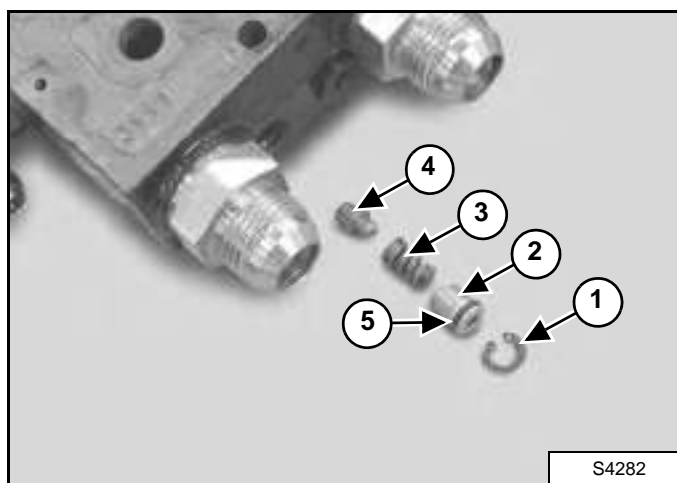

Remove the snap ring (Item 1), the plug (Item 2), the spring (Item 3) and the pin (Item 4) [Figure 20-170-36] from the inlet section.

Remove the O-ring (Item 5) [Figure 20-170-36] from the plug.

Figure 20-170-37

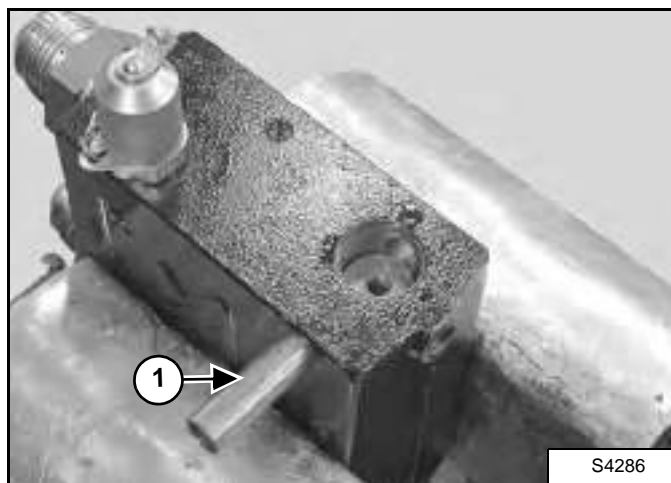

Press the pin (Item 1) [Figure 20-170-37] out such that it no longer blocks the valve.

Figure 20-170-38

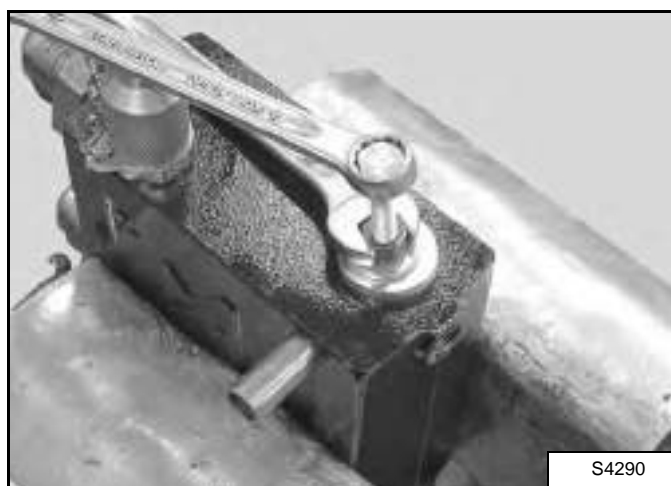

If the valve cannot be removed by hand, install a bolt in the threaded hole and carefully pull the plug (Item 1) [Figure 20-170-39] out with nut and washer as shown in the above figure [Figure 20-170-38].



## HYDRAULIC CONTROL VALVE (CONT'D)

### Inlet Section Disassembly And Assembly (Cont'd)

Figure 20-170-39

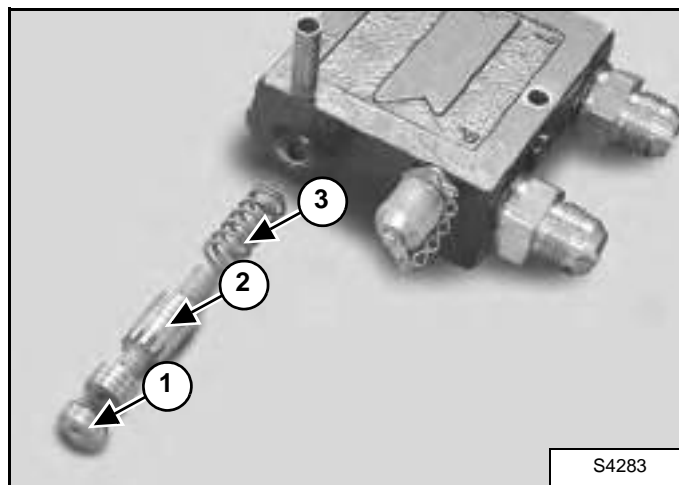

Remove the plug (Item 1), the spool (Item 2) and the spring (Item 3) [Figure 20-170-39] from the inlet section.

Figure 20-170-40

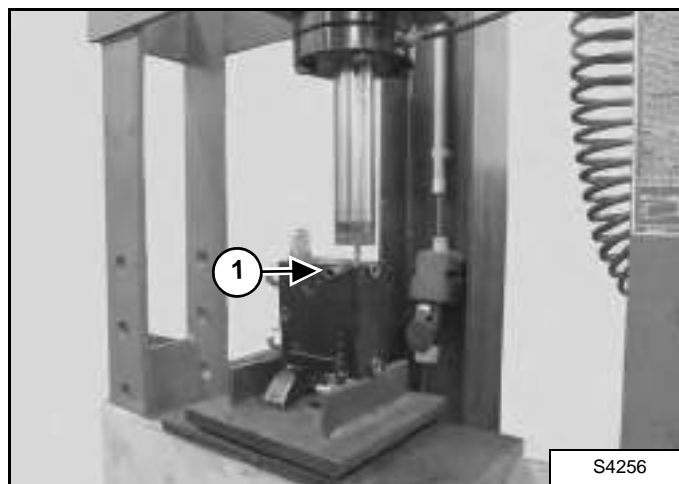

**Installation:** Use a hydraulic press to carefully install the spring, spool and plug in the hole and reinstall the pin (Item 1) [Figure 20-170-40] to keep the assembly in its place.



**Bobcat®**

## PORT RELIEF VALVES

### Removal And Installation

# IMPORTANT

When repairing hydrostatic and hydraulic systems, clean the work area before disassembly and keep all parts clean. Always use caps and plugs on hoses, tubelines and ports to keep dirt out. Dirt can quickly damage the system.

I-2003-0888

Remove the hydraulic control valve from the back of the machine (See "Removal And Installation" on page 20-170-4).

Remove the lift and tilt sections from the hydraulic control valve (See "Section Removal" on page 20-170-13)

Figure 20-171-1

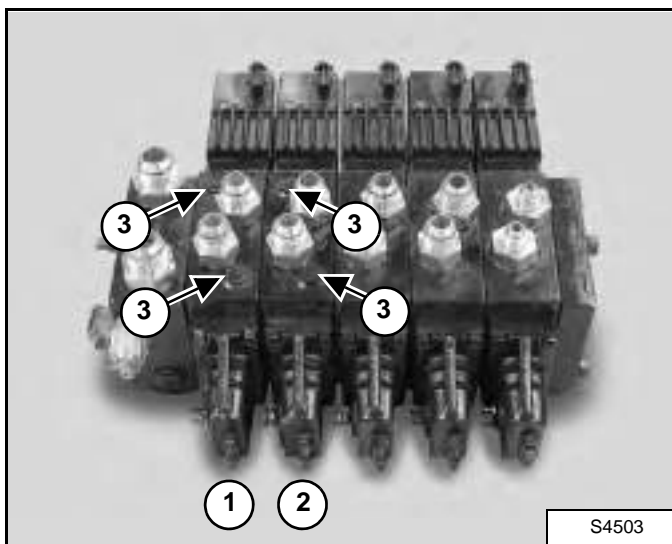

Only the tilting (Item 1) and lifting (Item 2) valve sections have port relief valves (Items 3) [Figure 20-171-1].

See "Section Disassembly And Assembly" on page 20-170-13 for disassembly of the port relief valves.



## FLOW CONTROL VALVE

### Removal And Installation

Figure 20-172-1



Remove the rear cover (Item 1) [Figure 20-172-1].

Figure 20-172-2

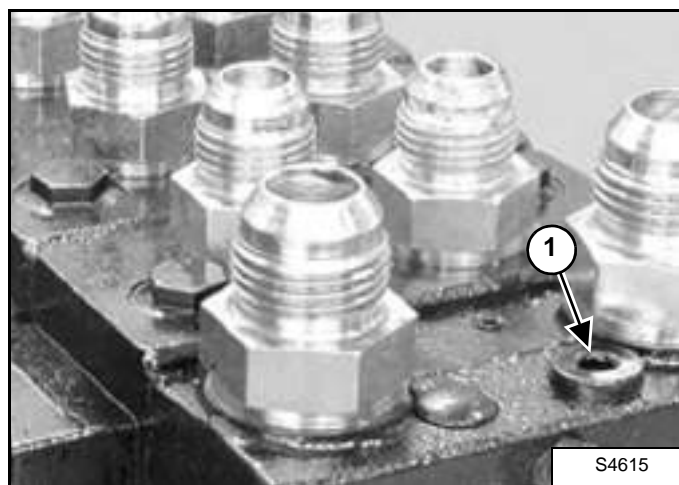

Remove the plug (Item 1) [Figure 20-172-2] from the upper left side of the hydraulic control valve and remove the flow control valve.

**Installation:** Tighten the flow control valve plug to 15 ft.-lb. (20 N•m) torque.



**Bobcat®**

## PARKING BRAKE

### Parking Brake Valve Removal And Installation

Figure 20-190-1

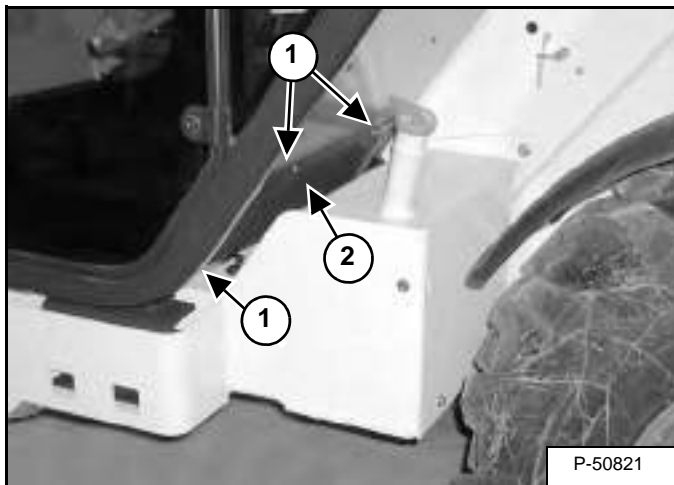

Relieve the hydraulic pressure.

Remove the three screws (Item 1) from the access panel (Item 2) [Figure 20-190-1].

Remove the access panel.

## WARNING

Hydraulic fluid escaping under pressure can have sufficient force to enter a person's body by penetrating the skin. This can cause serious injury and possible death if proper medical treatment by a physician familiar with this injury is not received immediately.

W-2145-0290

## IMPORTANT

When repairing hydrostatic and hydraulic systems, clean the work area before disassembly and keep all parts clean. Always use caps and plugs on hoses, tubelines and ports to keep dirt out. Dirt can quickly damage the system.

I-2003-0888

Mark all hoses and electrical connectors for correct installation.

Figure 20-190-2

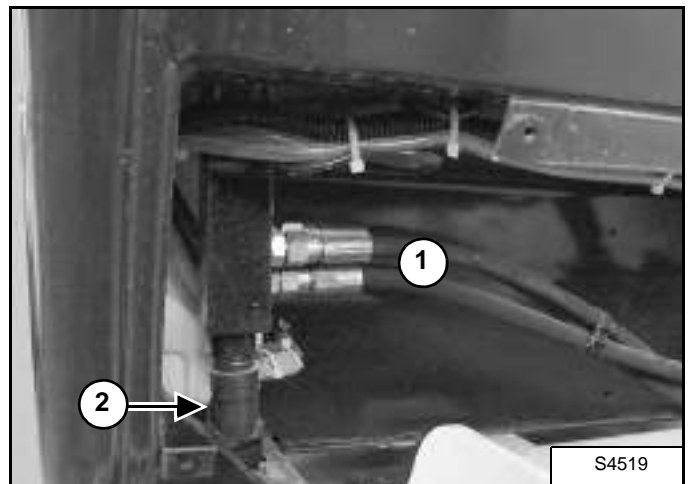

Remove the three hoses (Item 1). Unplug the electrical connector (Item 2) [Figure 20-190-2].

Figure 20-190-3

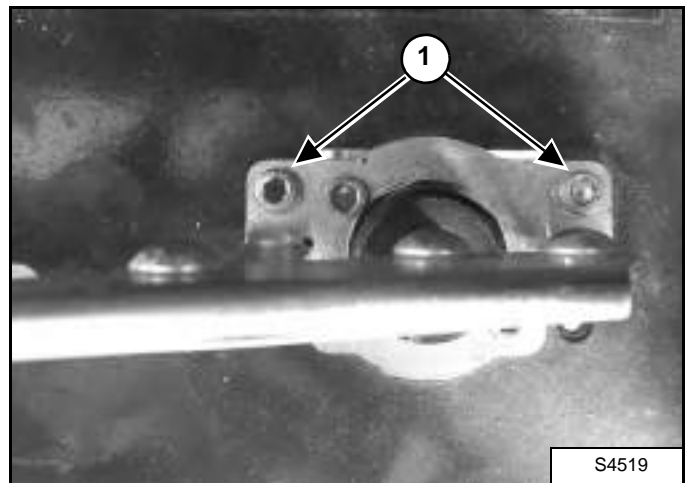

Remove the two screws (Item 1) [Figure 20-190-3] in order to loosen the parking brake lever.

## PARKING BRAKE (CONT'D)

### Parking Brake Valve Removal And Installation (Cont'd)

Figure 20-190-4

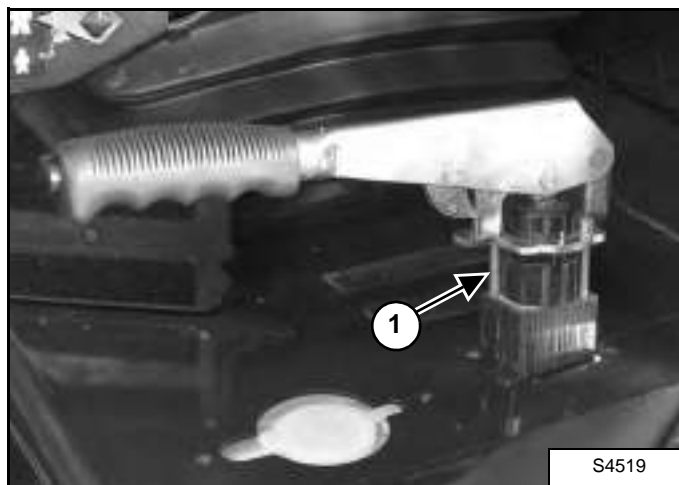

Lift the parking brake lever and valve (Item 1) [Figure 20-190-4] out the frame.

### Parking Brake Valve Disassembly And Assembly

Figure 20-190-5

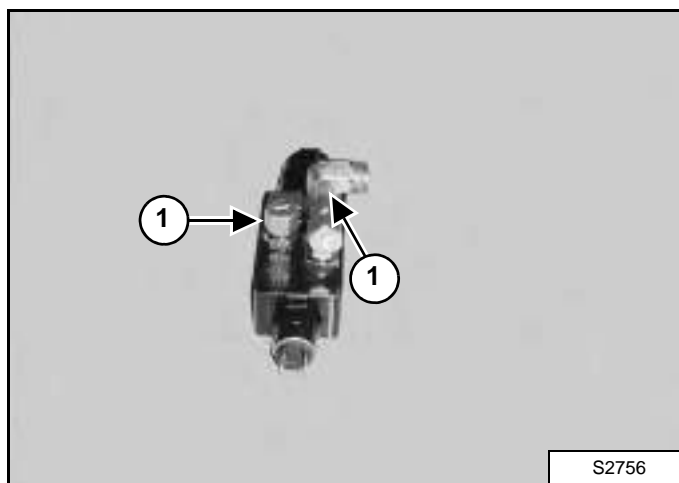

Remove the fittings (Item 1) [Figure 20-190-5].

Figure 20-190-6

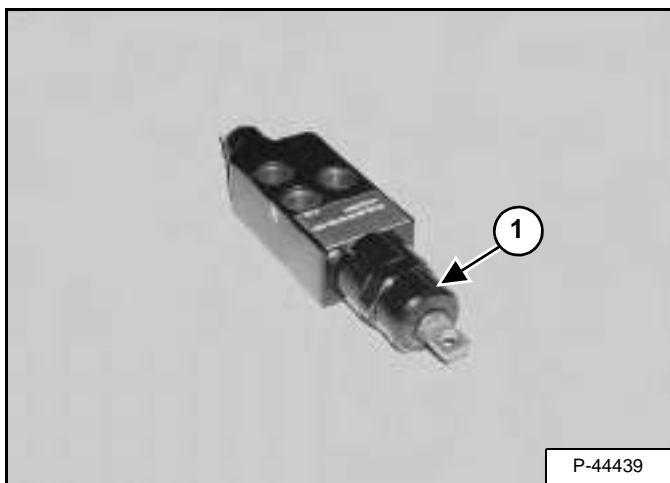

Loosen the collar (Item 1) [Figure 20-190-6].

**NOTE:** Use care removing the collar. The collar is under spring pressure.

Figure 20-190-7

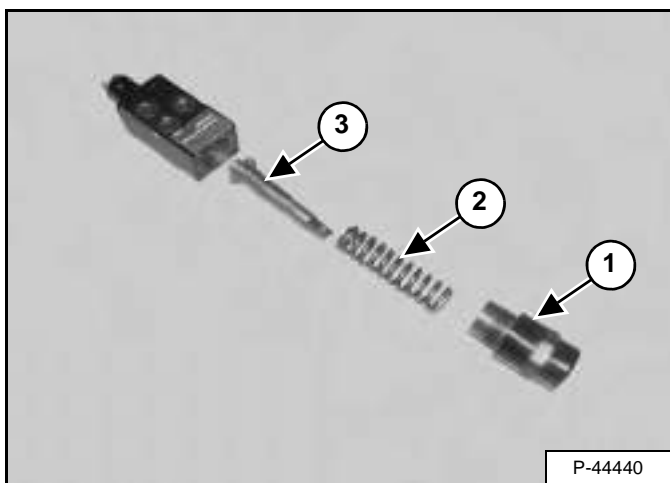

Remove the collar (Item 1), spring (Item 2) and shaft (Item 3) [Figure 20-190-7] from the housing.



## PARKING BRAKE (CONT'D)

### Parking Brake Valve Disassembly And Assembly (Cont'd)

Figure 20-190-8

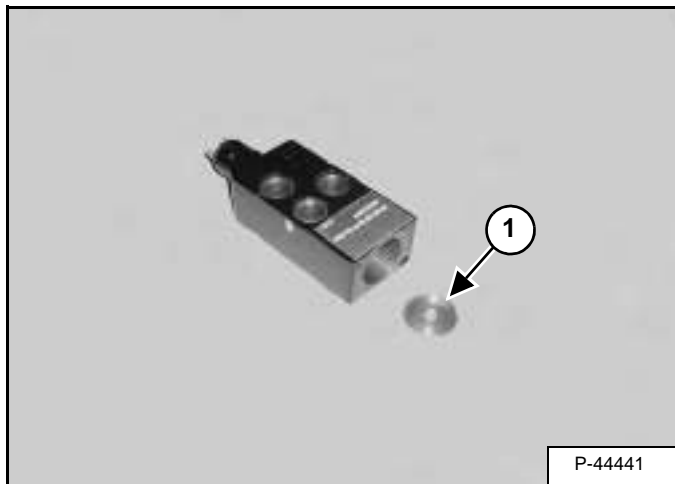

Remove the washer (Item 1) [Figure 20-190-8] from the housing

Figure 20-190-9

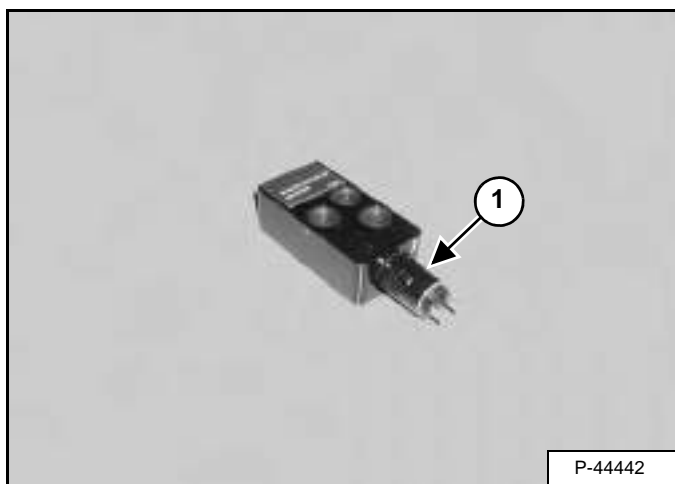

Remove the electrical connector (Item 1) [Figure 20-190-9] from the housing.



**Bobcat®**

## PRESSURE REDUCING VALVE

### Testing

Raise the boom and install the boom stop. (See “Installing The Approved Boom Stop” on page 10-150-1.)

Figure 20-200-1

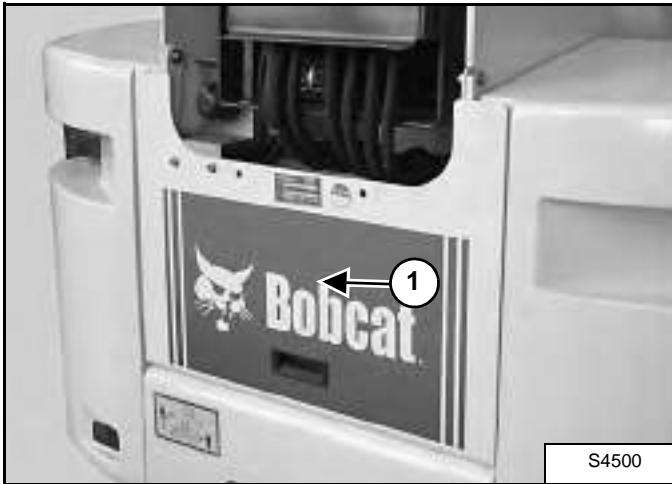

Remove the rear cover (Item 1) [Figure 20-200-1].

Figure 20-200-2

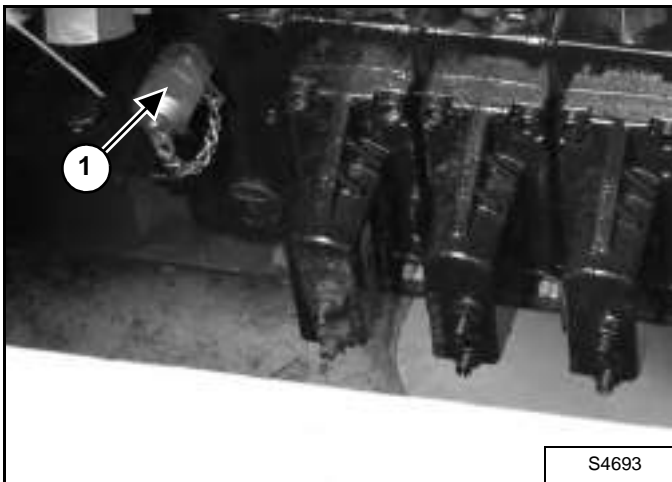

Locate the test fitting (Item 1) [Figure 20-200-2] below the control valve and remove the cap.

Figure 20-200-3

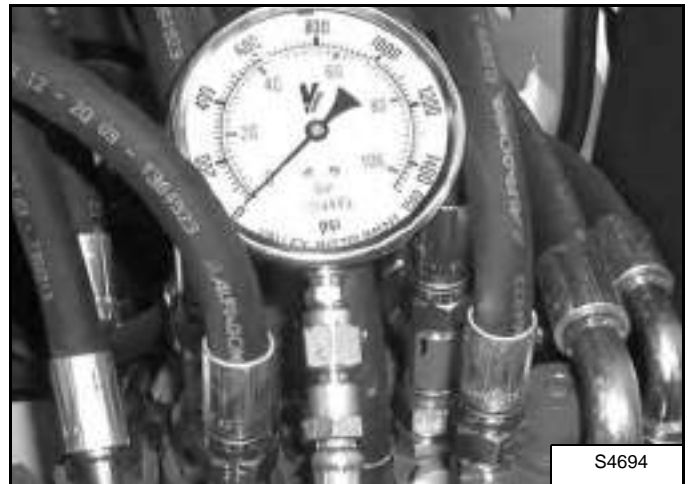

Install a 1000 psi (70 Bar) gauge on the test fitting [Figure 20-200-3].

Start the engine, lower the restraint bar (if equipped) and run engine at 2200 rpm.

Record the pressure. The pressure at the gauge should be 480 psi (33.10 Bar).

The pressure reducing valve is not adjustable. If the pressure is incorrect, replace the pressure reducing valve.

## PRESSURE REDUCING VALVE (CONT'D)

### Removal And Installation

Relieve hydraulic pressure. Drain the hydraulic reservoir. (See "Replacing Hydraulic Fluid" on page 10-100-2.)

Figure 20-200-4



Remove the rear cover (Item 1) [Figure 20-200-4].

Figure 20-200-5

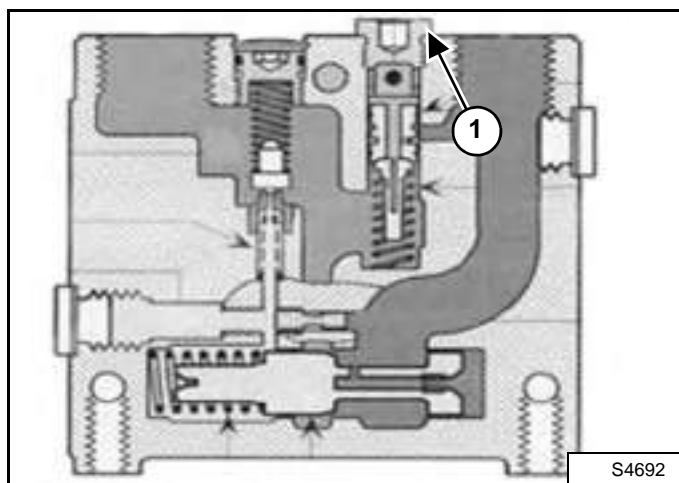

Locate the pressure reducing valve (Item 1) [Figure 20-200-5] at the upper side of the left valve block.

Figure 20-200-6

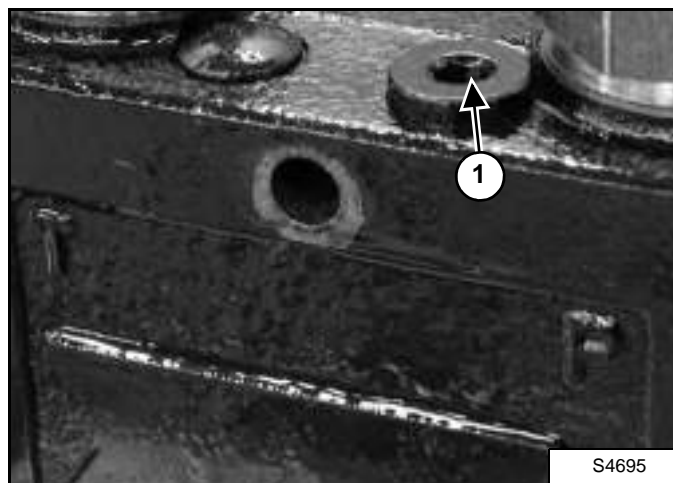

Remove the plug (Item 1) [Figure 20-200-6].

Figure 20-200-7

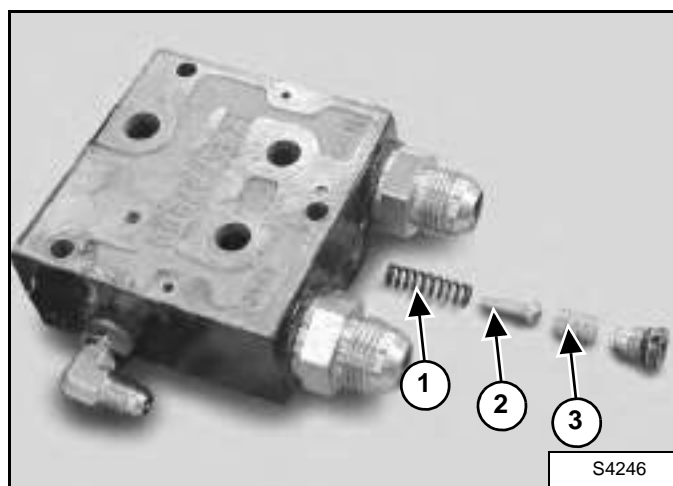

Remove the spring (Item 1), the bolt (Item 2) and the cylinder (Item 3) [Figure 20-200-7] out of the valve block.

## ACCUMULATOR

### Removal And Installation

The accumulator is located below the boom, and can be seen through an access hole on top of the frame.

## WARNING

Hydraulic fluid escaping under pressure can have sufficient force to enter a person's body by penetrating the skin. This can cause serious injury and possible death if proper medical treatment by a physician familiar with this injury is not received immediately.

W-2145-0290

## IMPORTANT

When repairing hydrostatic and hydraulic systems, clean the work area before disassembly and keep all parts clean. Always use caps and plugs on hoses, tubelines and ports to keep dirt out. Dirt can quickly damage the system.

I-2003-0888

Figure 20-210-1

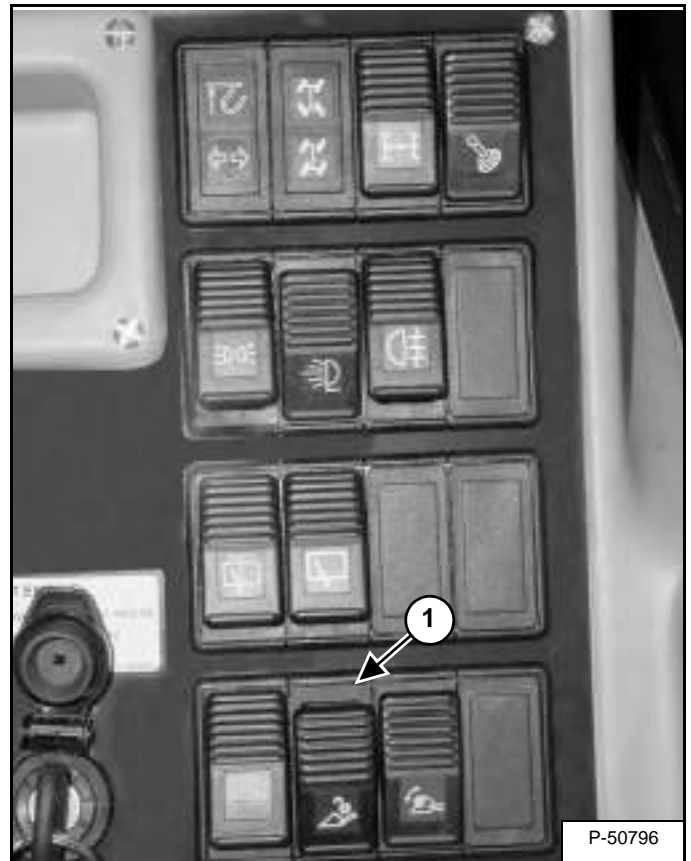

With the engine off, relieve the hydraulic pressure by pressing the bottom of the button (Item 1) [Figure 20-210-1].

Figure 20-210-2

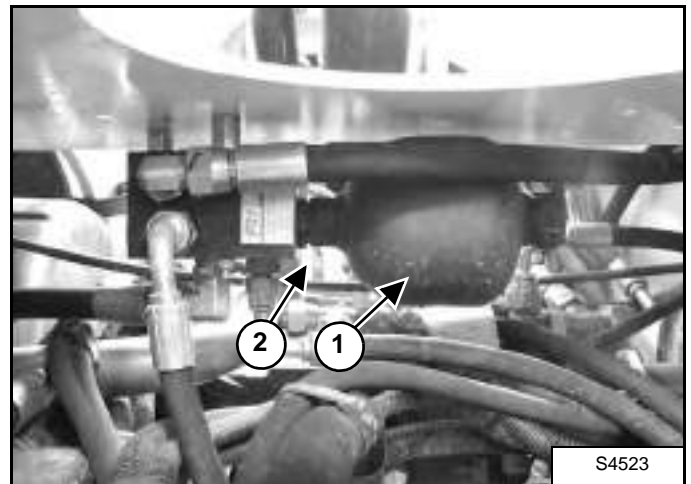

Remove the accumulator (Item 1) from the manifold (Item 2) [Figure 20-210-2].



**Bobcat®**

## TOW VALVE

### Removal And Installation

Open the engine cover.

Figure 20-220-1



Position the tow valve to towing position to relieve hydraulic pressure [Figure 20-220-1].

## WARNING

Hydraulic fluid escaping under pressure can have sufficient force to enter a person's body by penetrating the skin. This can cause serious injury and possible death if proper medical treatment by a physician familiar with this injury is not received immediately.

W-2145-0290

## IMPORTANT

When repairing hydrostatic and hydraulic systems, clean the work area before disassembly and keep all parts clean. Always use caps and plugs on hoses, tubelines and ports to keep dirt out. Dirt can quickly damage the system.

I-2003-0888

Figure 20-220-2

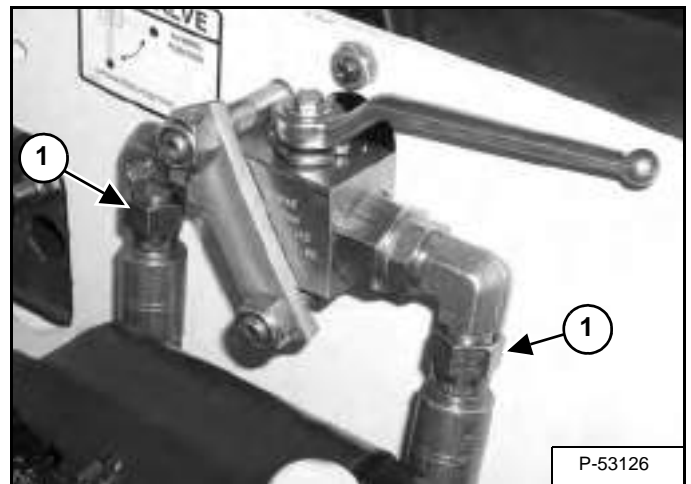

Mark the hoses for correct installation. Remove the two hoses (Item 1) [Figure 20-220-2].

Figure 20-220-3

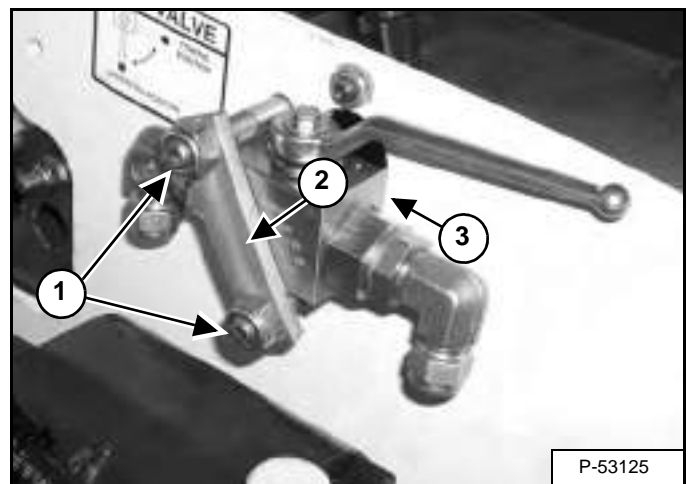

Remove the two bolts, nuts (Item 1) and strap (Item 2). Remove the tow valve (Item 3) [Figure 20-220-3].

## TOW VALVE (CONT'D)

### Disassembly And Assembly

Clean the outside of the tow valve before disassembly.

Mark the outside of the tow valve for ease of assembly.

Figure 20-220-4

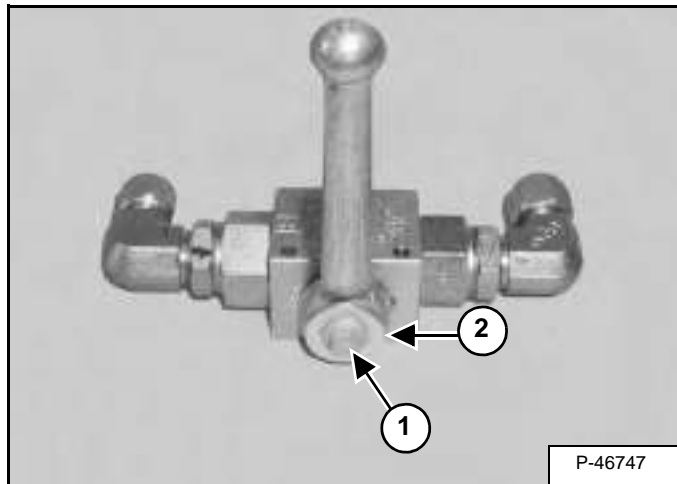

Remove the screw (Item 1) and washer (Item 2) [Figure 20-220-4].

Figure 20-220-5

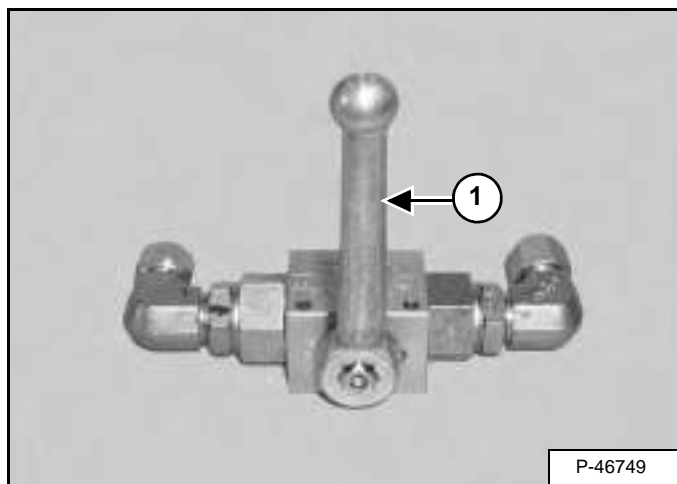

Remove the handle (Item 1) [Figure 20-220-5].

Figure 20-220-6

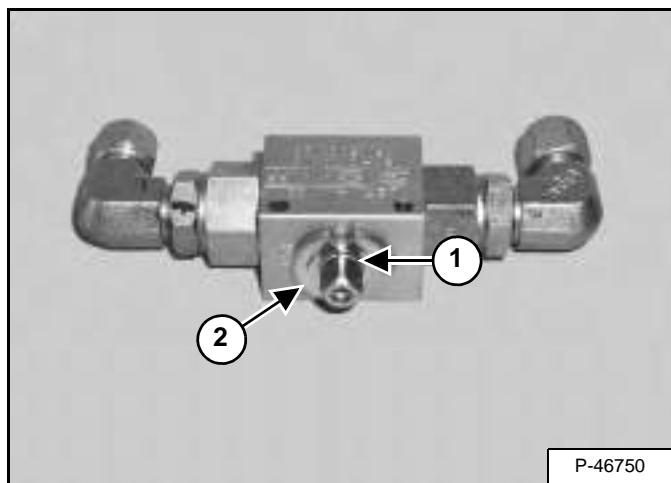

Remove the retainer (Item 1) and stop plate (Item 2) [Figure 20-220-6].

**NOTE:** Record the position of the stop plate for proper assembly.

Figure 20-220-7

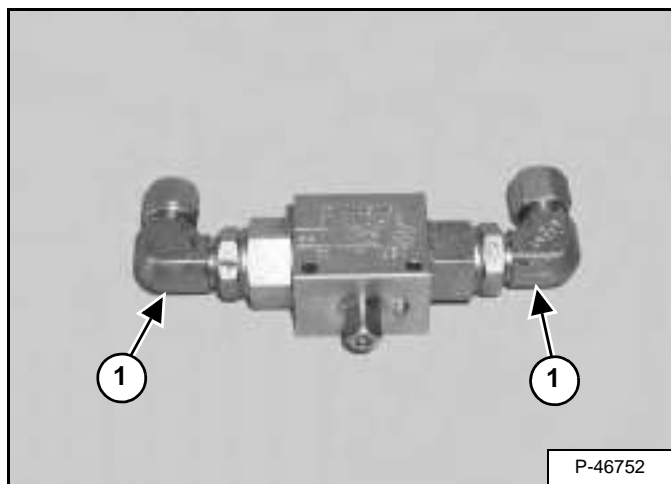

Remove the two fittings (Item 1) [Figure 20-220-7].



## TOW VALVE (CONT'D)

### Disassembly And Assembly (Cont'd)

Figure 20-220-8

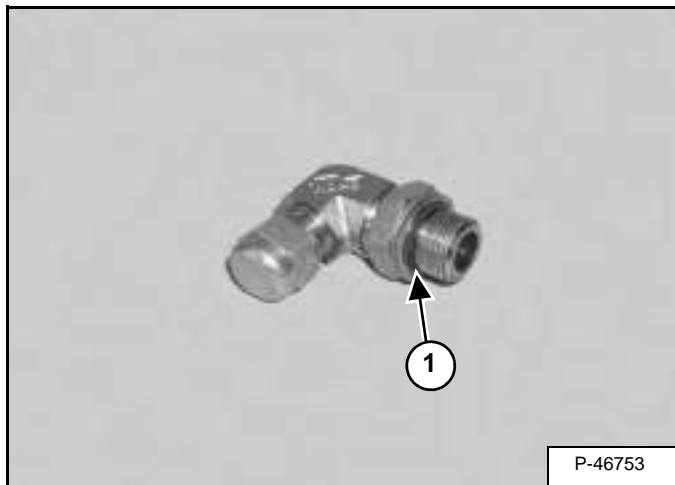

Remove the O-ring (Item 1) [Figure 20-220-8] from the fittings.

Figure 20-220-9

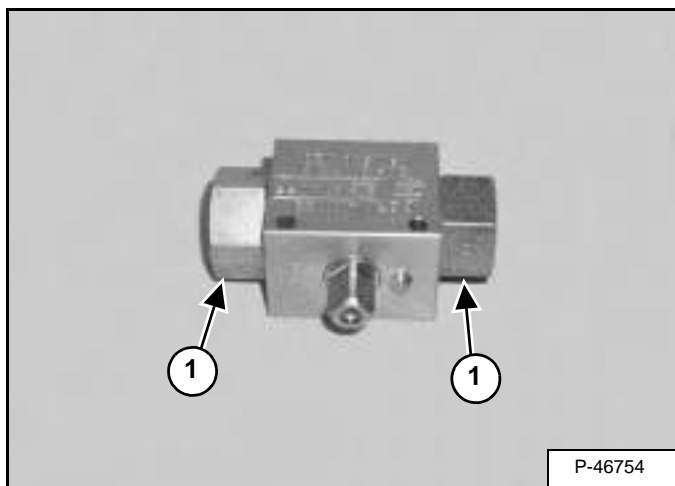

Remove the two adapters (Item 1) [Figure 20-220-9].

Figure 20-220-10

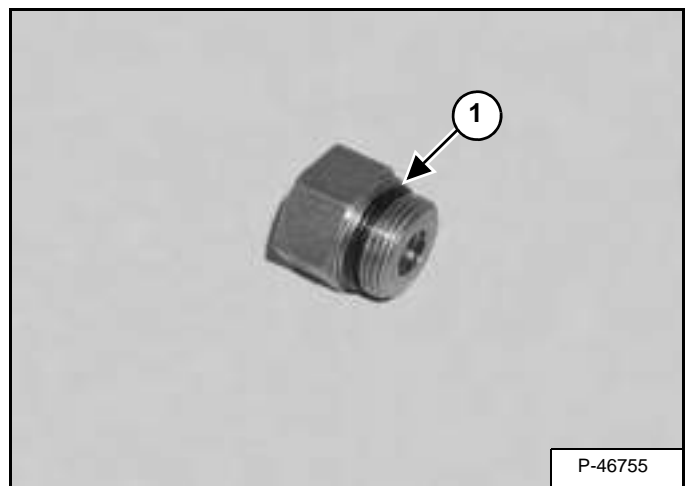

Remove the O-ring (Item 1) [Figure 20-220-10] from the adapters.

## TOW VALVE (CONT'D)

### Disassembly And Assembly (Cont'd)

Figure 20-220-11

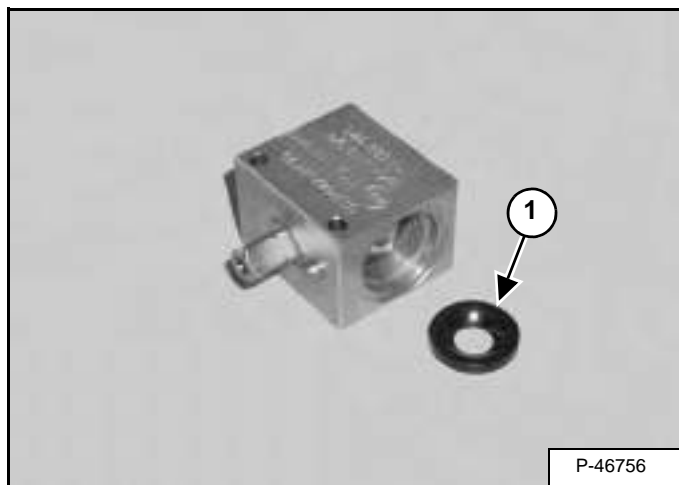
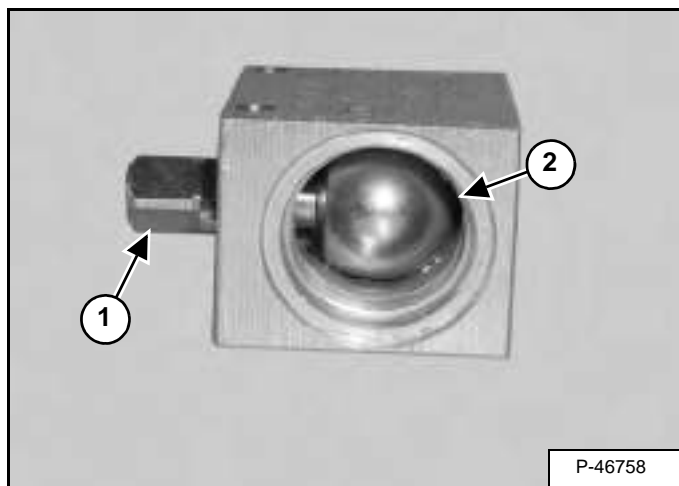

Figure 20-220-12



Remove the seal (Item 1) [Figure 20-220-11] from the valve. (Both sides)

**Assembly:** The concave side of the seal (Item 1) [Figure 20-220-11] fits over the ball (Item 2) [Figure 20-220-12].

Turn the shaft (Item 1) until the shaft and ball (Item 2) [Figure 20-220-12] are in the position shown. Remove the ball.

**Assembly:** Record the position of the shaft and ball for proper assembly.

Figure 20-220-13

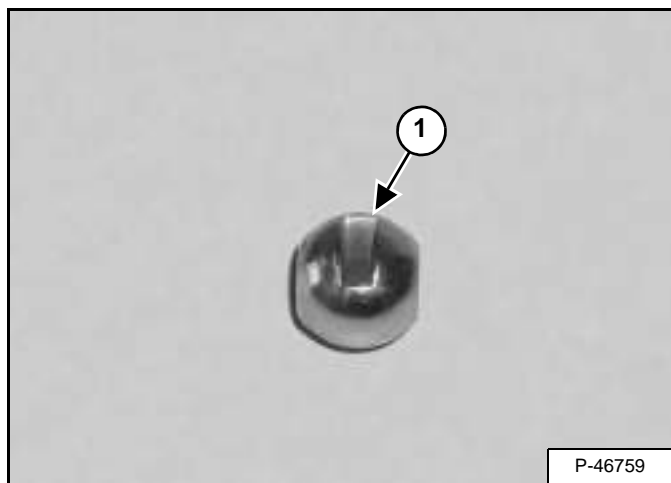
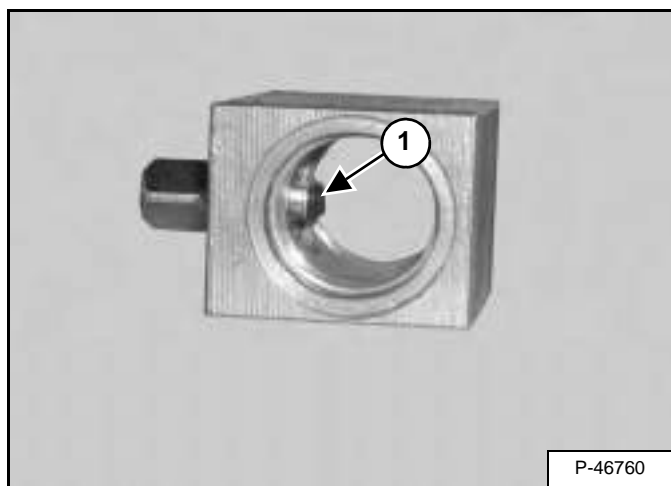

Figure 20-220-14



**Assembly:** Align the slot (Item 1) [Figure 20-220-13] with the notch (Item 1) [Figure 20-220-14] in the shaft.

## TOW VALVE (CONT'D)

### Disassembly And Assembly (Cont'd)

Figure 20-220-15

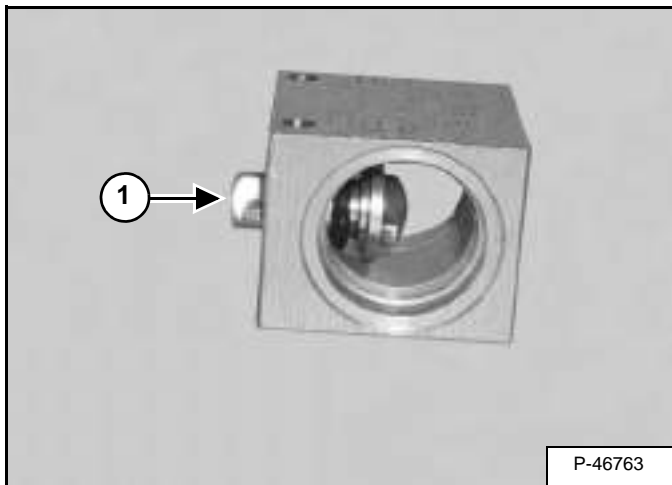

Remove the shaft (Item 1) [Figure 20-220-15] by pressing the shaft into the housing.

Figure 20-220-16

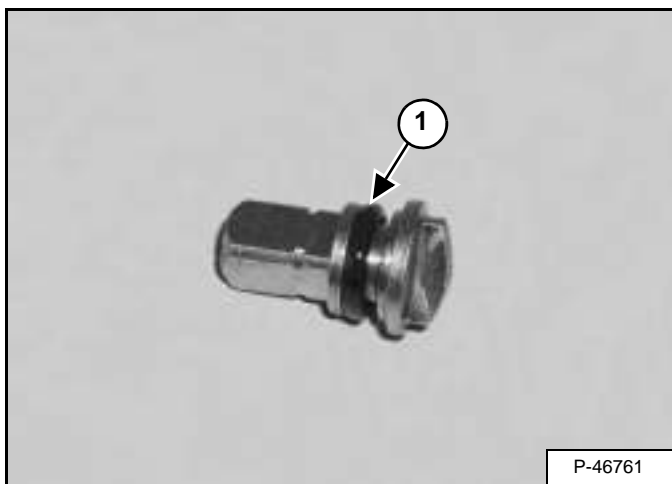

Remove the O-ring (Item 1) [Figure 20-220-16] from the shaft.

Figure 20-220-17

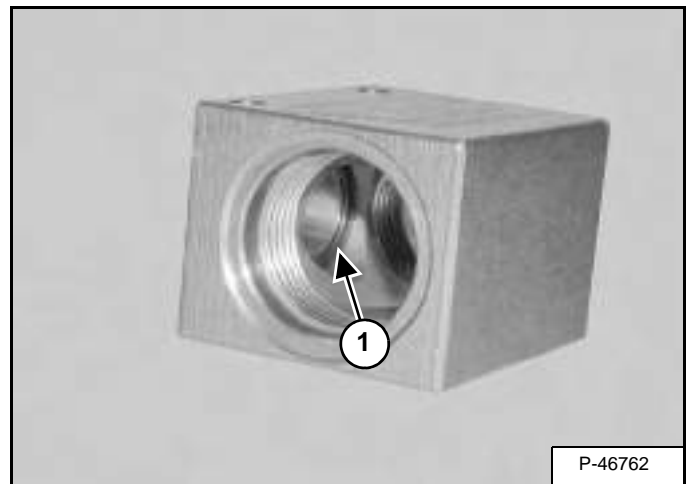

Remove the seal (Item 1) [Figure 20-220-17] from the housing.

Clean all parts in solvent and dry with compressed air.

Inspect all parts for wear or damage. Replace any worn or damaged parts.

Always install new seals and O-rings. Lubricate all seals and O-rings with clean hydraulic fluid before installation.



**Bobcat®**

## STABILIZER CYLINDER

### Removal And Installation

Figure 20-250-1



Extend and support the boom on adequate stands [Figure 20-250-1].

## IMPORTANT

When repairing hydrostatic and hydraulic systems, clean the work area before disassembly and keep all parts clean. Always use caps and plugs on hoses, tubelines and ports to keep dirt out. Dirt can quickly damage the system.

I-2003-0888

Figure 20-250-2

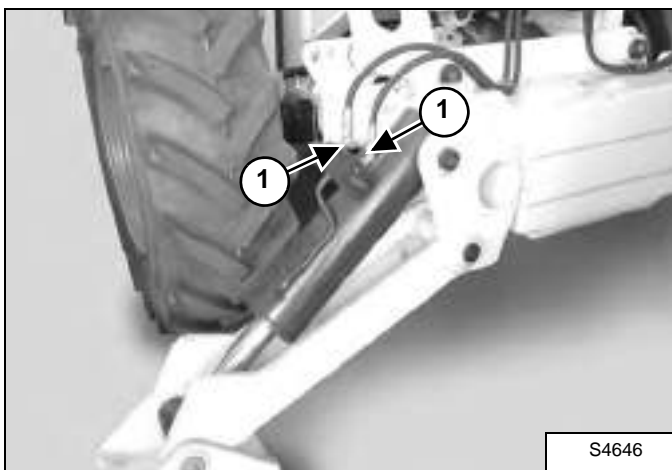

Disconnect both hoses (Item 1) [Figure 20-250-2] and put caps on the connections to prevent bleeding the hydraulic tank.

Figure 20-250-3

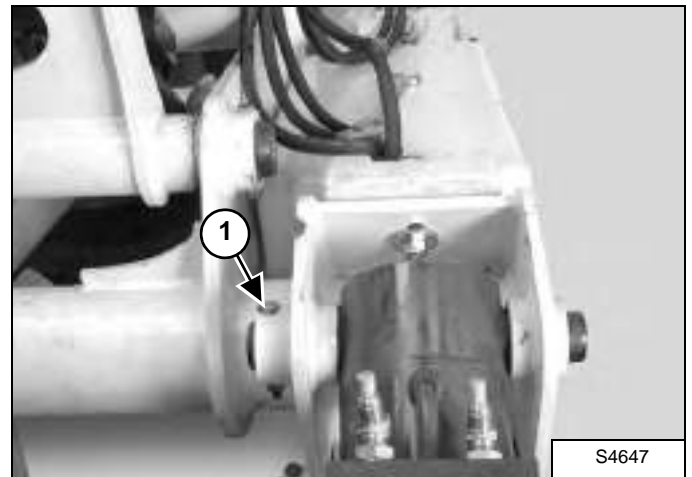

Remove the pivot pin retainer bolt (Item 1) [Figure 20-250-3].

Figure 20-250-4

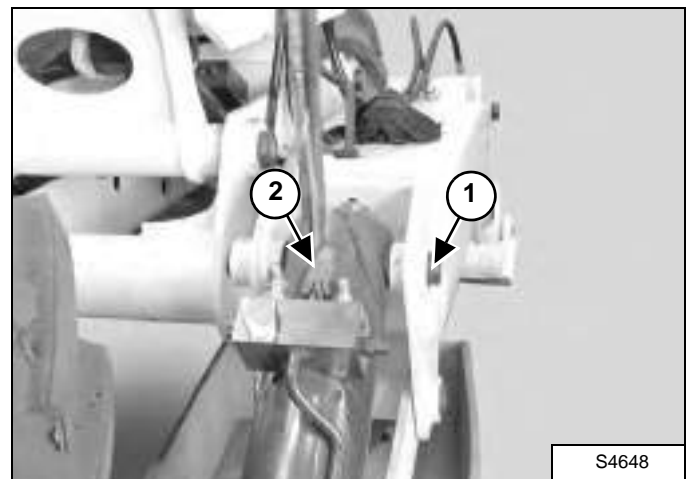

Remove the pin (Item 1) [Figure 20-250-4].

Support the cylinder by using a lifting strap (Item 2) [Figure 20-250-4].

## STABILIZER CYLINDER (CONT'D)

### Removal And Installation (Cont'd)

Figure 20-250-5

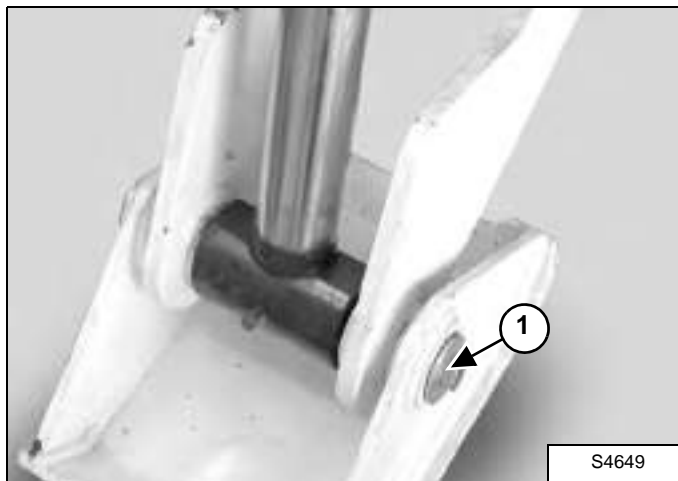

Remove the nut and washer (Item 1) [Figure 20-250-5] on one side of the pivot pin.

Figure 20-250-6

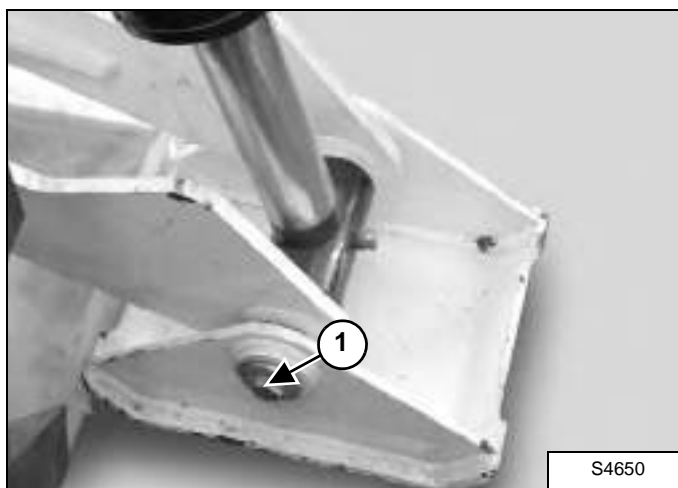

Remove the nut and washer (Item 1) [Figure 20-250-6] on the other side of the pivot pin.

Remove the pivot pin (Item 2) [Figure 20-250-6] from the stabilizer cylinder.

Figure 20-250-7



Remove the stabilizer cylinder from the front of the machine [Figure 20-250-7].

## STABILIZER CYLINDER (CONT'D)

### Parts Identification

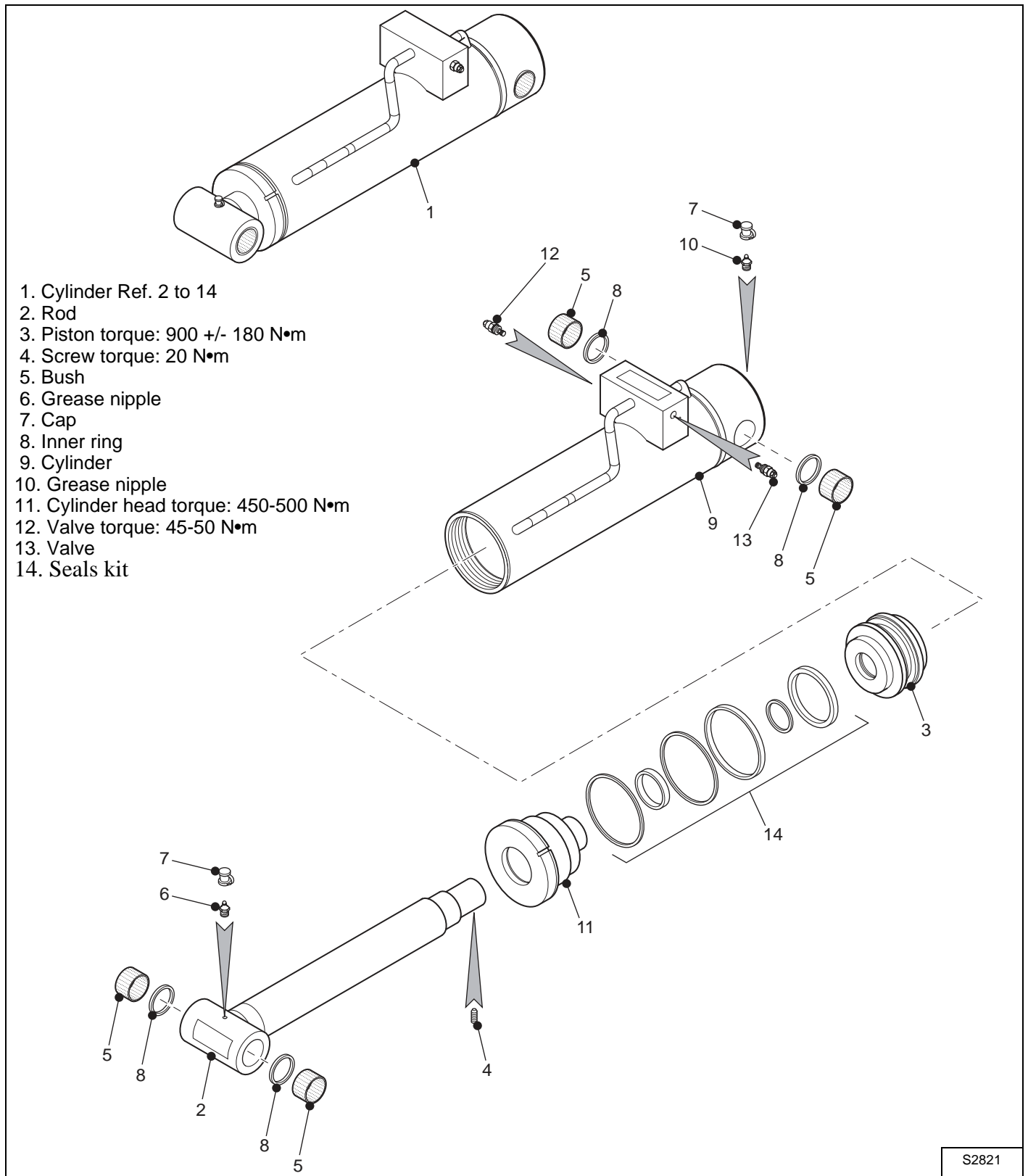

## STABILIZER CYLINDER (CONT'D)

### Disassembly

Figure 20-250-8

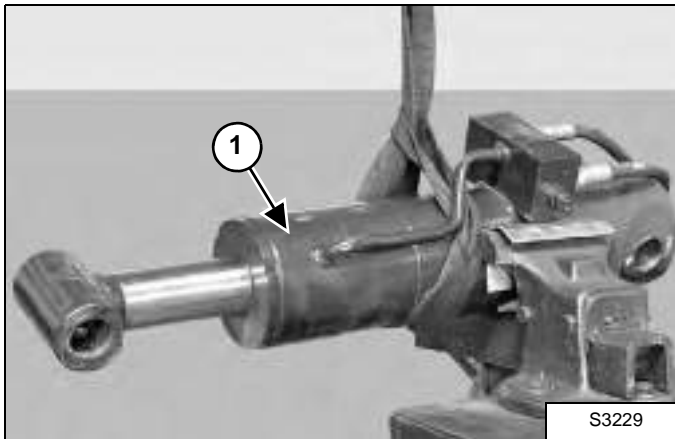

Place the cylinder (Item 1) [Figure 20-250-8] in a vise.

Figure 20-250-9

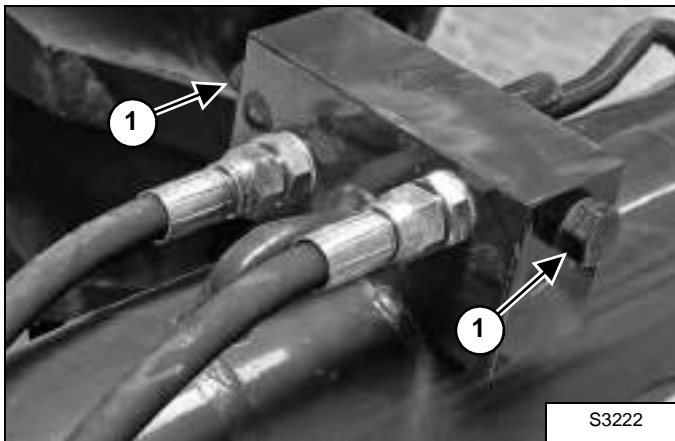

Remove both relief cartridges (Item 1) [Figure 20-250-9] from the cylinder.

Figure 20-250-10

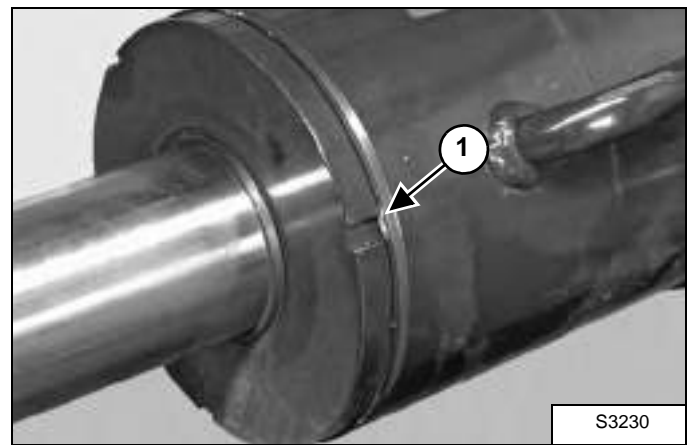

Carefully peen the lock ring (Item 1) [Figure 20-250-10] from the head gland.

Figure 20-250-11

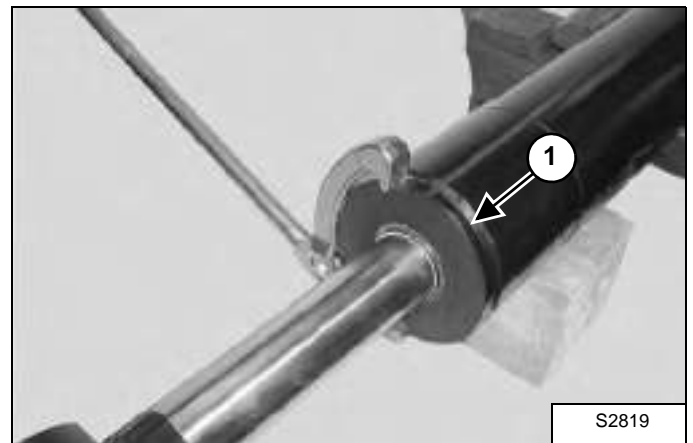

Loosen the head gland (Item 1) [Figure 20-250-11].



---

## STABILIZER CYLINDER (CONT'D)

### Assembly

Use the following tool to assemble the cylinder: MEL1075-Adjustable Gland Nut Wrench

Wash the cylinder parts in solvent and dry with compressed air.

Inspect the cylinder parts for damage. Replace any damaged parts.

Lubricate all O-rings and seals with hydraulic oil during installation. Always use new O-rings and seals.

Clean off any old residue, and apply LOCTITE 242 or equivalent to the threads on the rod (Item 2). Install the piston (Item 3) onto the rod and tighten (See "Parts Identification" on page 10-10-3).

Apply LOCTITE 242 or equivalent to the threads of the set screw (Item 4) (See "Parts Identification" on page 20-250-3).



**Bobcat®**

# STABILIZER CONTROL VALVE

## Parts Identification

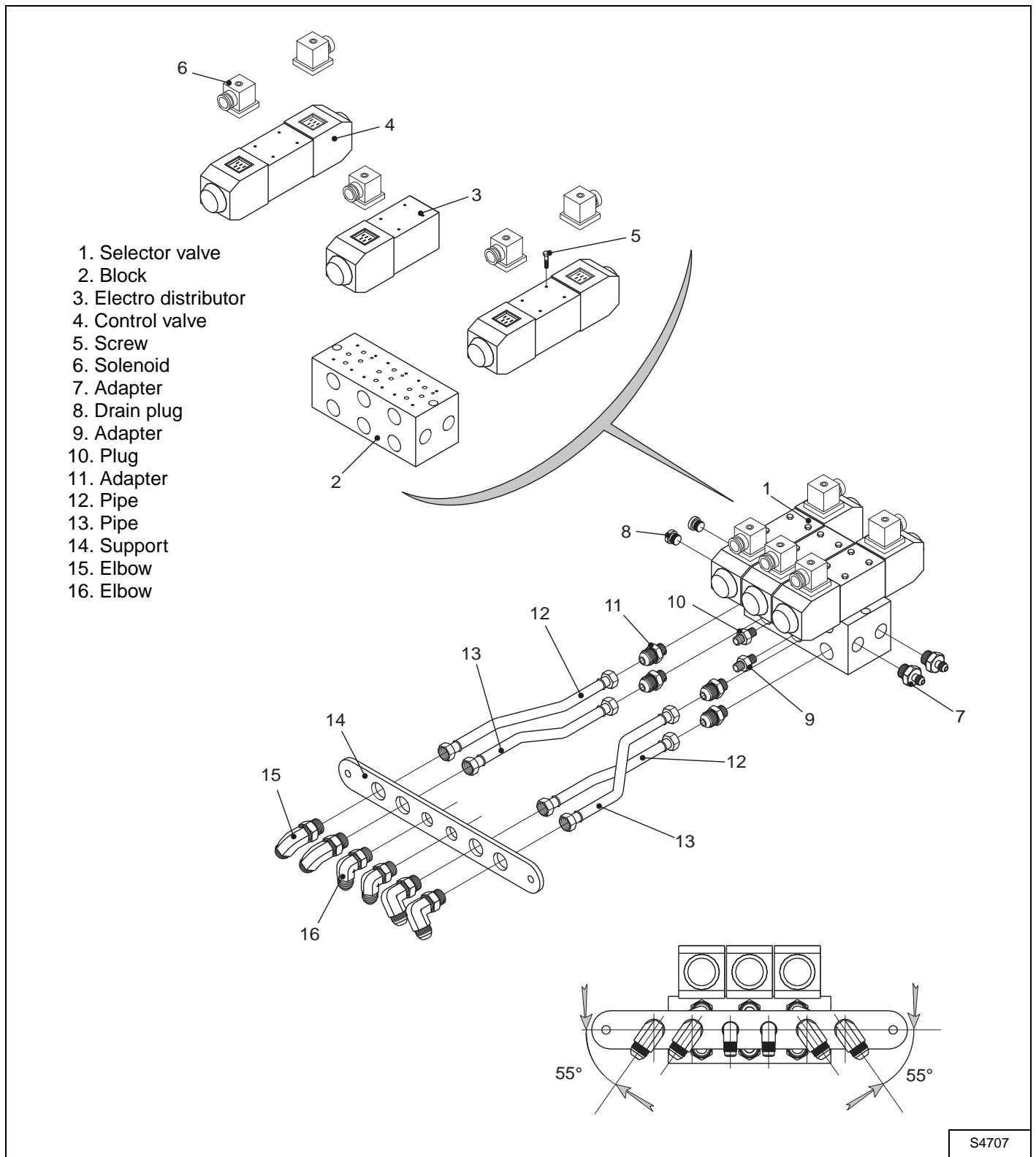

## STABILIZER CONTROL VALVE (CONT'D)

### Removal

Figure 20-260-1

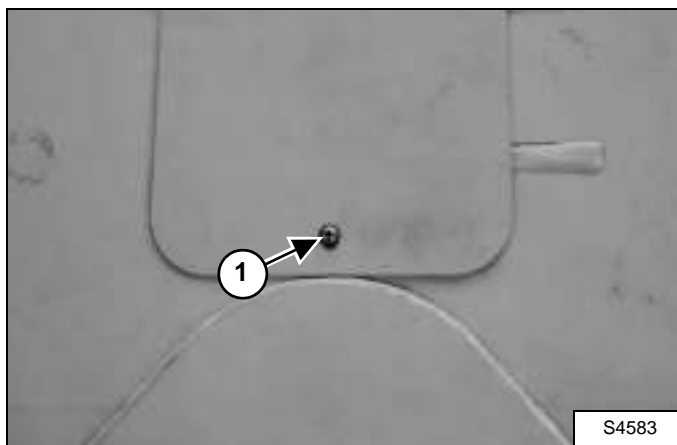

Remove the screw (Item 1) to remove the cover (Item 2) [Figure 20-260-1].

Figure 20-260-2

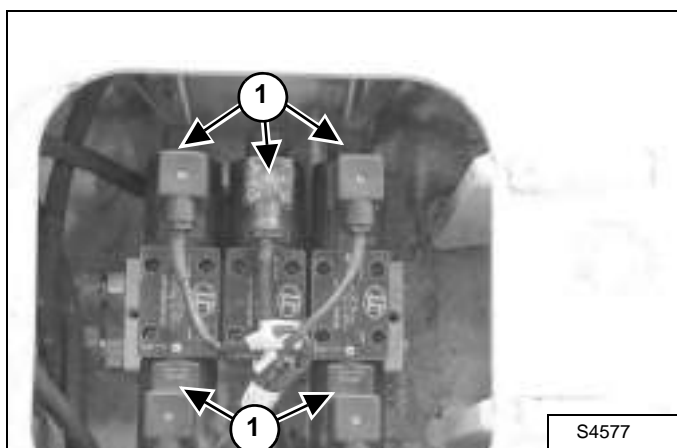

Disconnect the five coils (Item 1) [Figure 20-260-2] by loosening the screws and remove the coils.

Figure 20-260-3

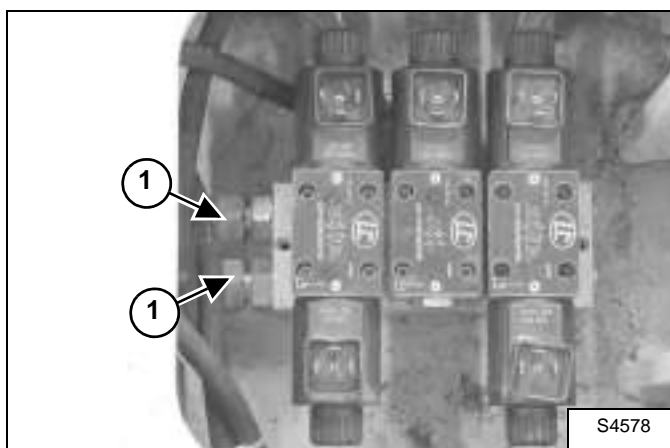

Disconnect the two hoses (Item 1) [Figure 20-260-3] from the stabilizer control valve and cap them.

Figure 20-260-4

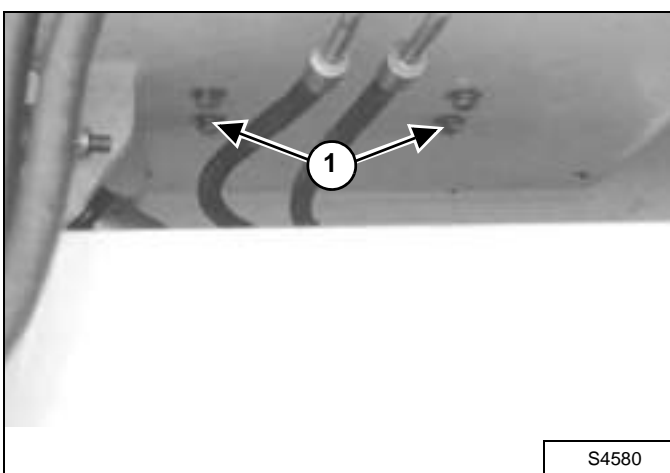

Remove the four screws (Item 1) [Figure 20-260-4] from the bottom of the stabilizer control valve.

## STABILIZER CONTROL VALVE (CONT'D)

### Removal (Cont'd)

Figure 20-260-5

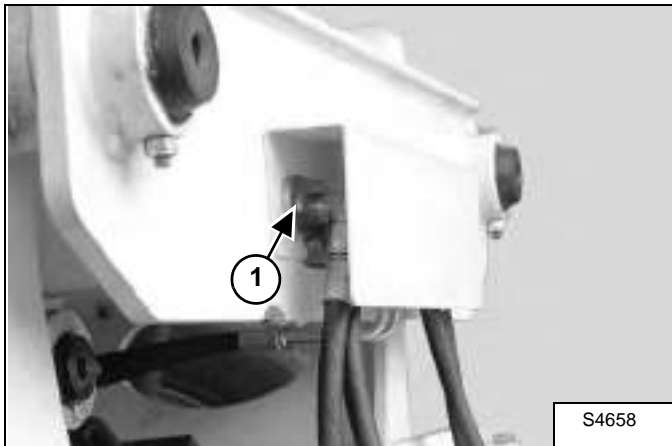

Remove the two bolts (Item 1) and remove the cover (Item 2) [Figure 20-260-5] from the front of the machine.

Figure 20-260-6

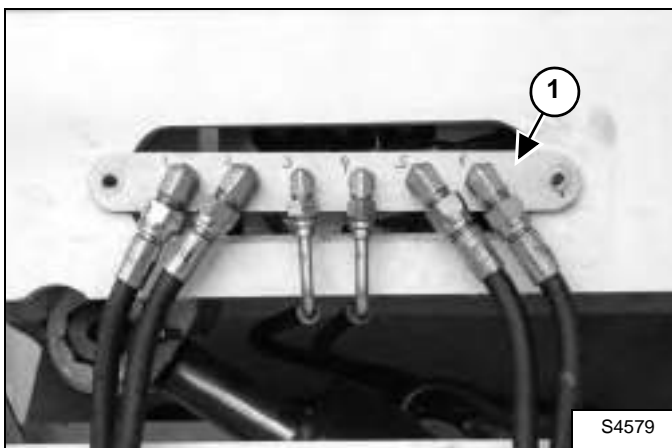

Pull the plate with the hoses (Item 1) [Figure 20-260-6] back from the front of the machine.

Figure 20-260-7

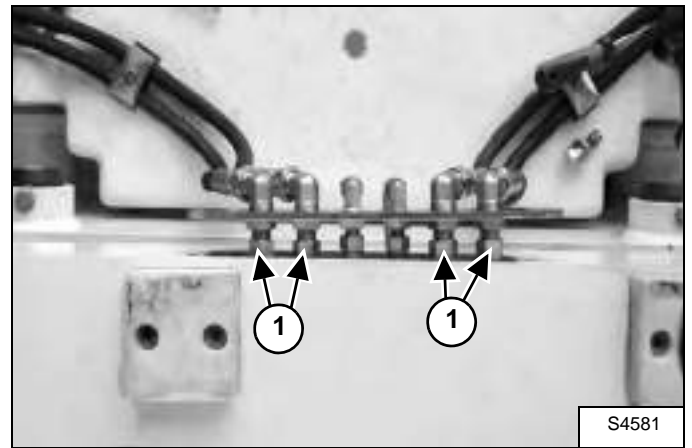

Disconnect the four hydraulic tubelines (Item 1) [Figure 20-260-7] from the plate and cap the hoses and the couplings.

Figure 20-260-8

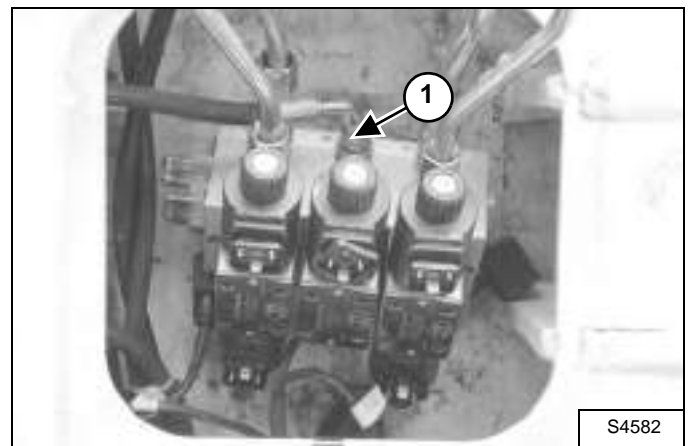

Turn the stabilizer control valve and disconnect the hose (Item 1) [Figure 20-260-8] from the control valve.

---

## STABILIZER CONTROL VALVE (CONT'D)

### Removal

Figure 20-260-9

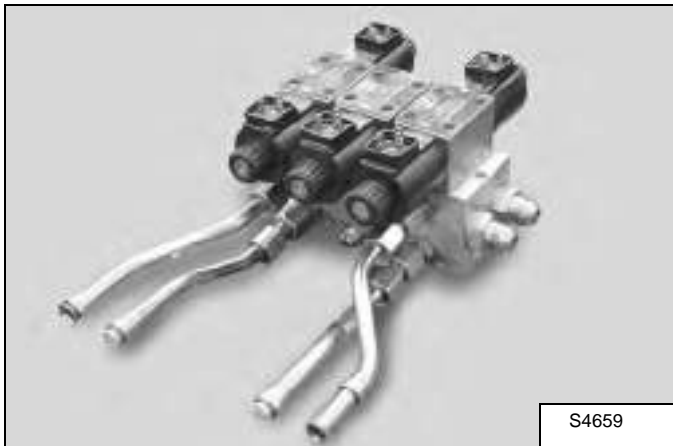

Remove the stabilizer control valve from the front of the machine [Figure 20-260-9].

---

## HYDROSTATIC SYSTEM

HYDROSTATIC DRIVE MOTOR . . . . .	.30-30-1
Assembly . . . . .	.30-30-22
Disassembly . . . . .	.30-30-5
Inspection . . . . .	.30-30-20
Parts Identification . . . . .	.30-30-2
Removal And Installation . . . . .	.30-30-1
HYDROSTATIC PUMP . . . . .	.30-40-1
Assembly . . . . .	.30-40-21
Disassembly . . . . .	.30-40-7
Inspection . . . . .	.30-40-17
Parts Identification . . . . .	.30-40-3
Removal And Installation . . . . .	.30-40-1
HYDROSTATIC SYSTEM INFORMATION . . . . .	.30-10-1
Replenishing Valve Function . . . . .	.30-10-2
Troubleshooting Chart . . . . .	.30-10-1
OIL COOLER . . . . .	.30-20-1
Description . . . . .	.30-20-1

**HYDROSTATIC  
SYSTEM**



**Bobcat®**



## HYDROSTATIC SYSTEM INFORMATION

### Troubleshooting Chart

The following troubleshooting chart is provided for assistance in locating and correcting problems which are most common. Many of the recommended procedures must be done by authorized Bobcat Service Personnel only.

# IMPORTANT

**Always keep the same size tires on the same side of the skid steer loader to avoid damage to the loader. Rotate tires according to the procedure given in the manual.**

I-2004-1285

PROBLEM	CAUSE
The Telescopic Handler does not move	1, 2
The Telescopic Handler does not move in a straight line.	3, 4
The hydrostatic system is overheating.	5, 6, 7, 8
Warning light comes ON.	5, 8, 9, 10, 11

KEY TO CORRECT THE CAUSE
1. The hydrostatic pump has damage.
2. The hydrostatic motor has damage.
3. The tires do not have the correct tire pressure.
4. The tires are not the same size.
5. The hydrostatic fluid is not at the correct level.
6. The oil cooler has a restriction.
7. The temperature sending switch is not operating correctly.
8. The Telescopic Handler is not being operated at the correct RPM.
9. The sender is defective.
10. Pump is defective or worn hydrostatics
11. Hydraulic filter is plugged.

Replenishing Valve Function

Figure 30-10-1

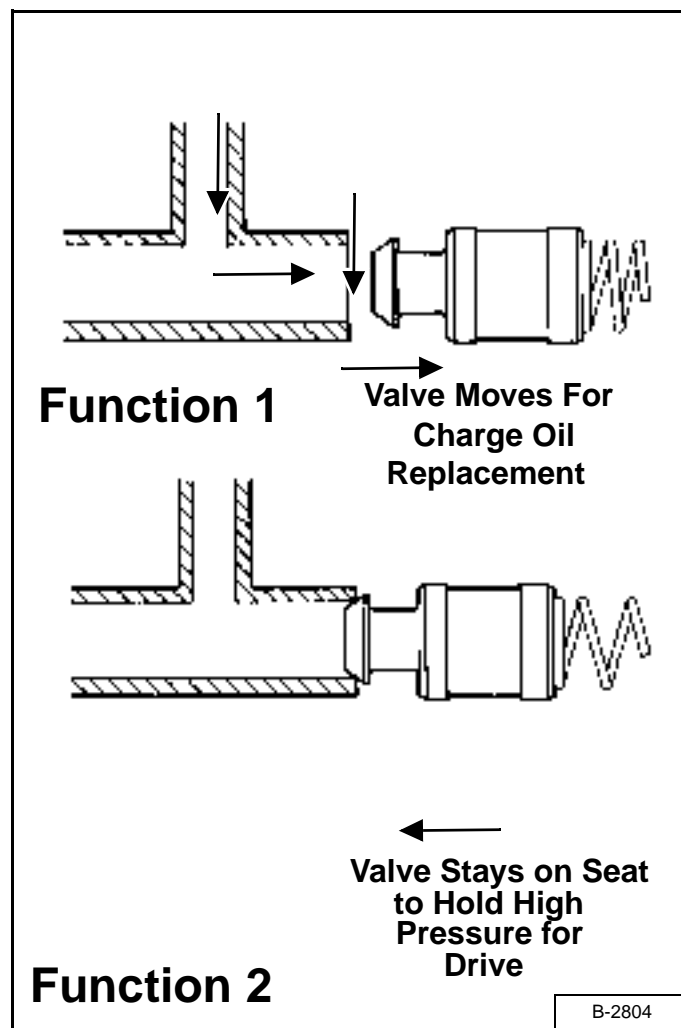

## IMPORTANT

When repairing hydrostatic and hydraulic systems, clean the work area before disassembly and keep all parts clean. Always use caps and plugs on hoses, tubelines and ports to keep dirt out. Dirt can quickly damage the system.

I-2003-0888

The functions of the replenishing valves are:

1. To give replacement fluid to the low pressure side of the hydrostatic circuit. Replacement fluid is needed because of normal internal leakage and the controlled flow to the oil cooler for cooling; Function 1 [Figure 30-10-1].
2. To keep high pressure fluid out of the low pressure side of the hydrostatic circuitry; Function 2 [Figure 30-10-1].

---

## **OIL COOLER**

### **Description**

The oil cooler is a combined radiator / oil cooler. See "Removal And Installation" on page 70-50-1 for Radiator / Oil Cooler Removal And Installation.



**Bobcat®**

---

## HYDROSTATIC DRIVE MOTOR

### Removal And Installation

Remove the front axle (See "Removal" on page 40-30-1).

**Figure 30-30-1**

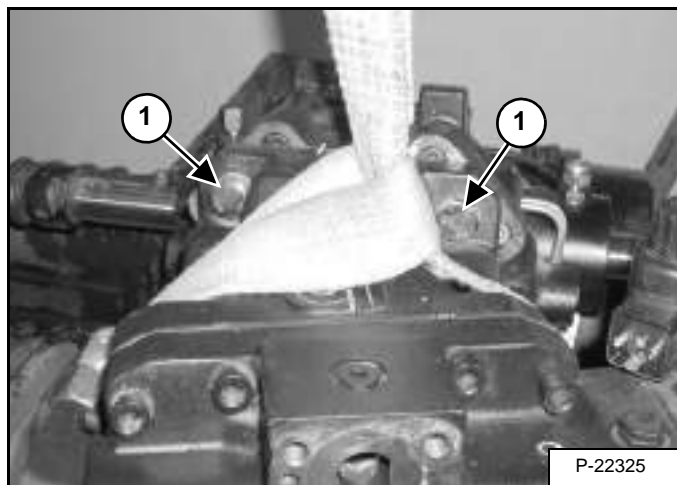

Install a chain hoist and lifting strap to lift and support the drive motor **[Figure 30-30-1]**.

Remove the four mounting bolts (Item 1) **[Figure 30-30-1]** from the drive motor.

**Installation:** Tighten the mounting bolts to 140-155 ft.-lb. (190-210 N•m) torque.

Remove the hydrostatic drive motor from the axle housing.

# HYDROSTATIC DRIVE MOTOR (CONT'D)

## Parts Identification

1. Bolt
2. End Cap
3. Plug
4. O-ring
5. Seal
6. Servo Piston
7. Feed Back Lug
8. Nut
9. Adjuster
10. Rod
11. Set Screw
12. Spring seat
13. Spring
14. Spool
15. Orifice
16. Housing
17. Solenoid

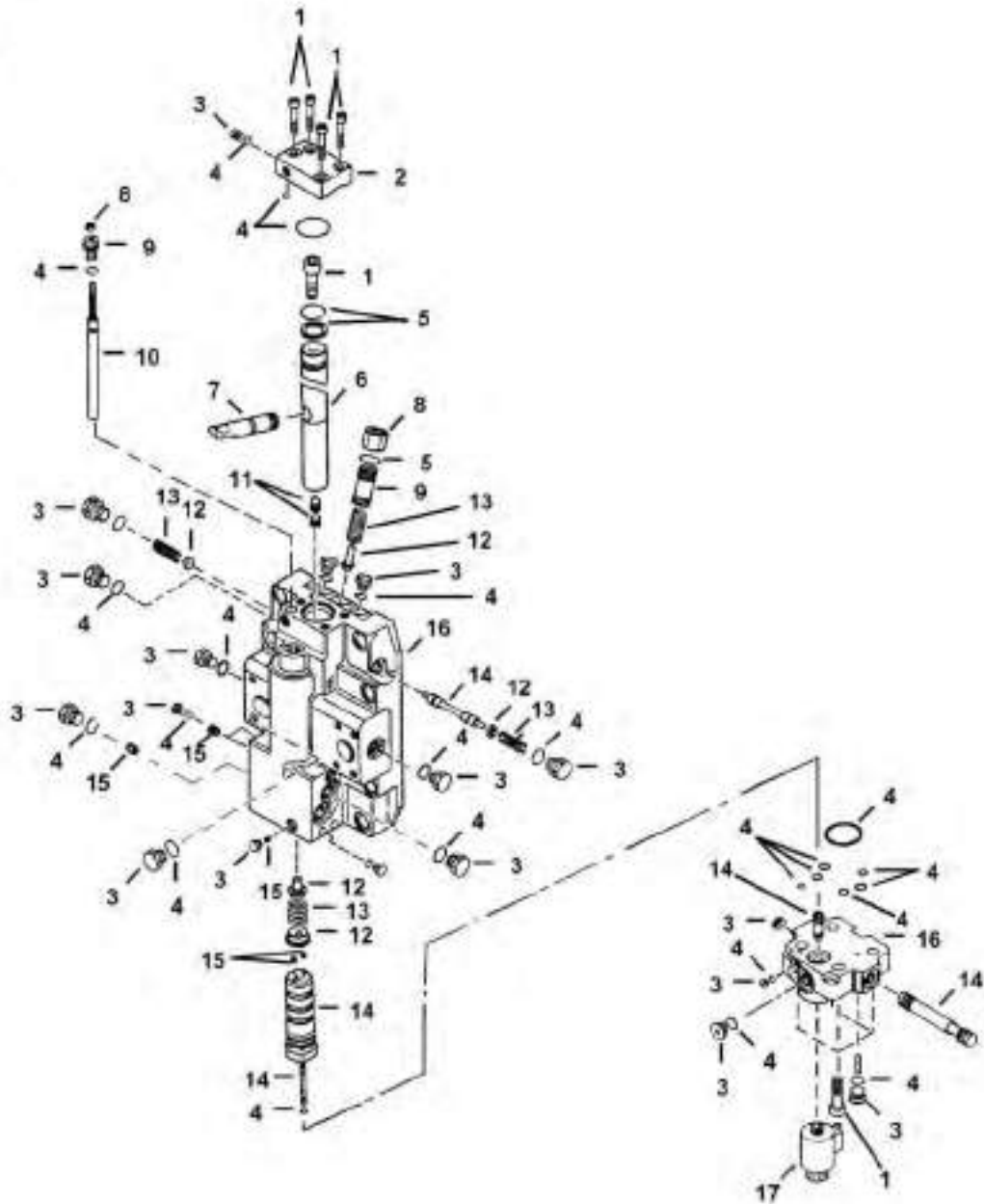

B-18528

# HYDROSTATIC DRIVE MOTOR (CONT'D)

## Parts Identification (Cont'd)

1. Valve Segment
2. Plate
3. Pins
4. Bearing
5. Cylinder
6. Pin
7. Synchronizing Shaft
8. Rollers
9. Bolt
10. Nut
11. Cap
12. Plug
13. O-Ring
14. Ring
15. Piston
16. Spring Seat
17. Spring
18. Shaft
19. Bearing
20. Spacer
21. Nut
22. O-Ring
23. Seal
24. Housing

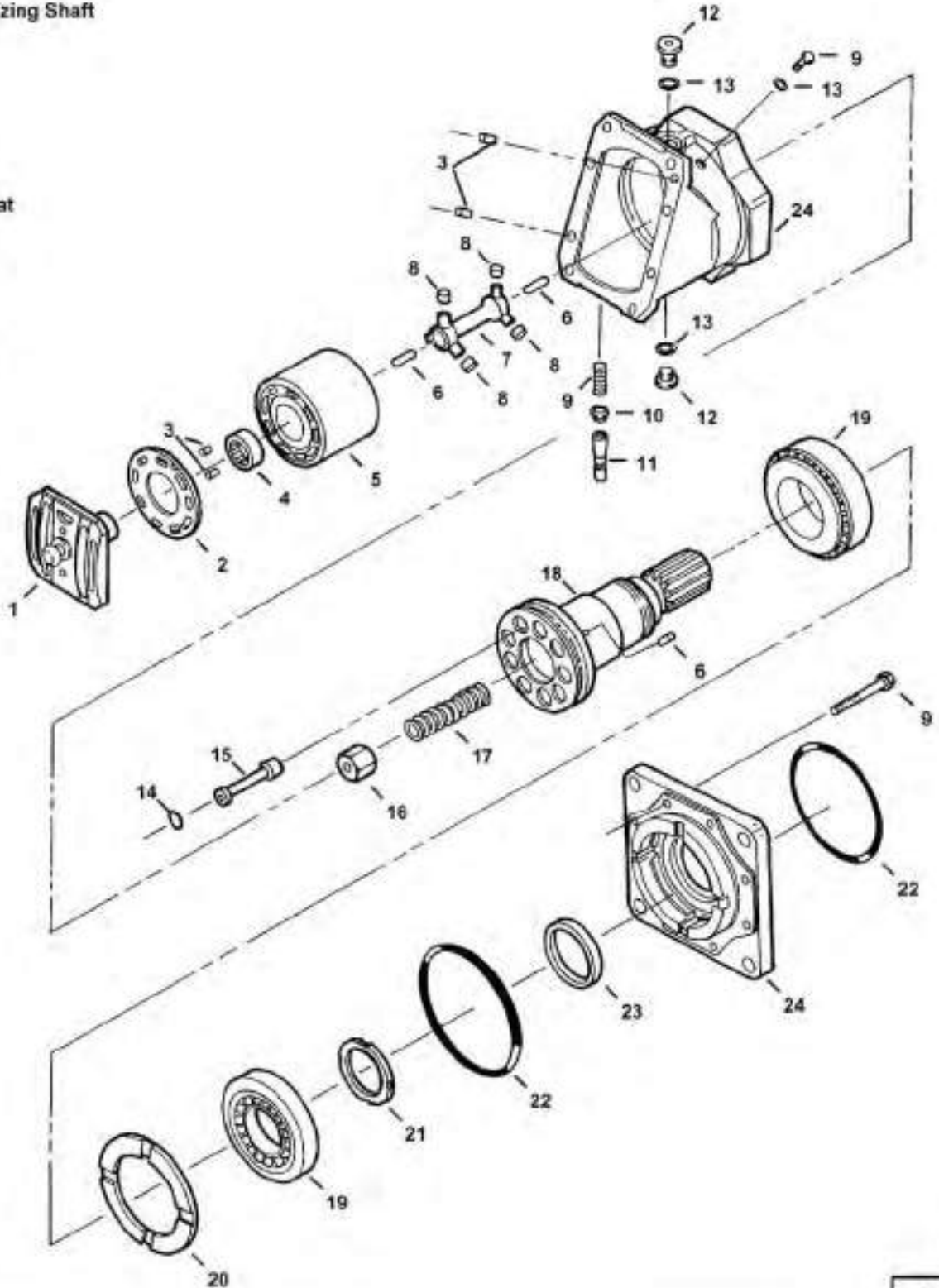

B-15897

## HYDROSTATIC DRIVE MOTOR (CONT'D)

### Parts Identification (Cont'd)

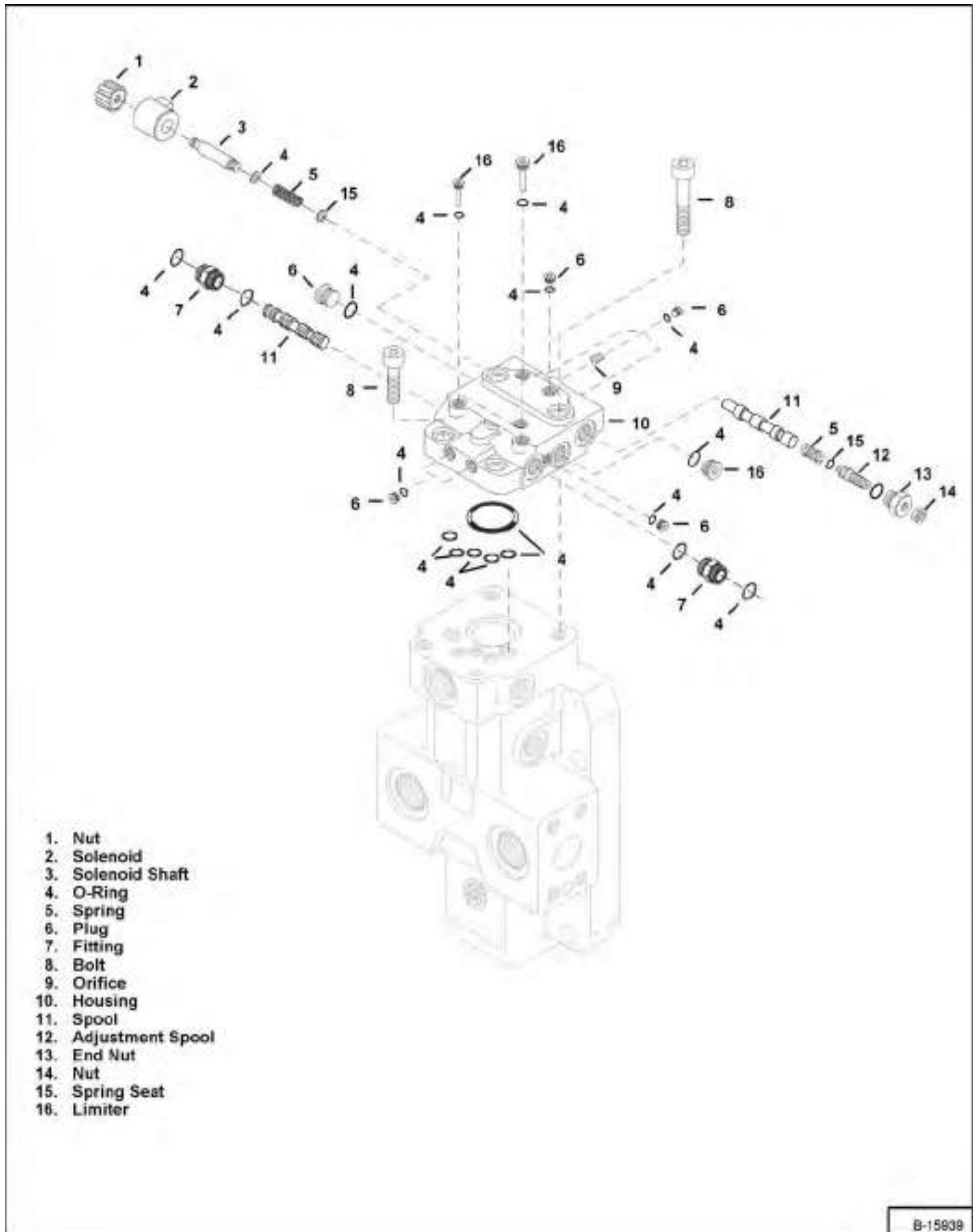

B-15939



## HYDROSTATIC DRIVE MOTOR (CONT'D)

### Disassembly

# IMPORTANT

When repairing hydrostatic and hydraulic systems, clean the work area before disassembly and keep all parts clean. Always use caps and plugs on hoses, tubelines and ports to keep dirt out. Dirt can quickly damage the system.

I-2003-0888

Figure 30-30-2



Place the hydrostatic drive motor on a work surface, mark the sections for correct assembly [Figure 30-30-2].

Figure 30-30-3

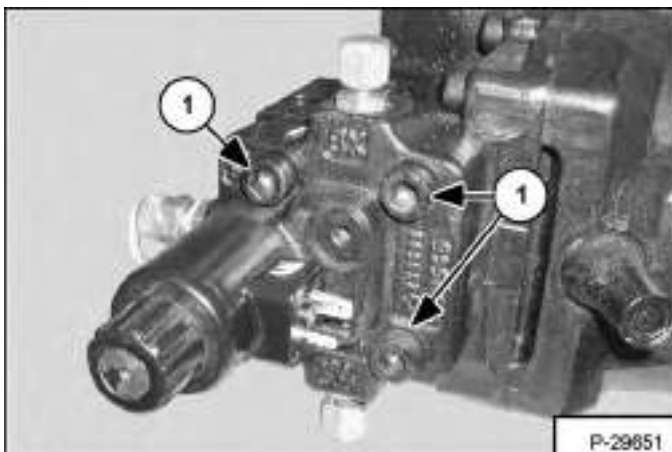

Remove the four bolts (Item 1) [Figure 30-30-3] and remove the solenoid housing.

Figure 30-30-4

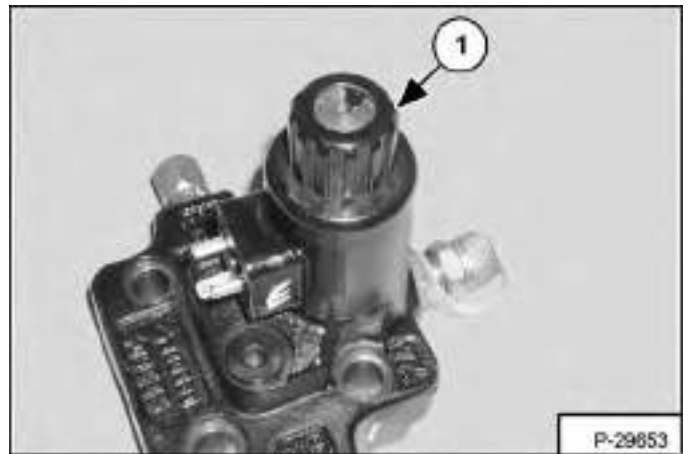

Remove the solenoid nut (Item 1) [Figure 30-30-4].

Figure 30-30-5

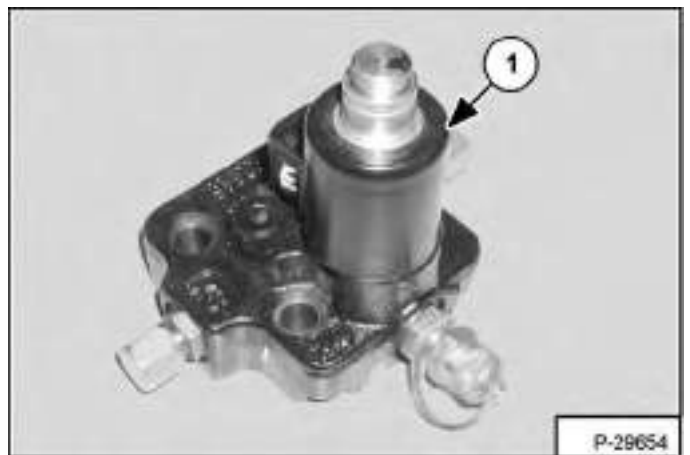

Remove the solenoid (Item 1) [Figure 30-30-5] from the shaft.

## HYDROSTATIC DRIVE MOTOR (CONT'D)

### Disassembly (Cont'd)

Figure 30-30-6



Remove and discard the O-ring (Item 1) [Figure 30-30-6] from the solenoid.

Figure 30-30-7

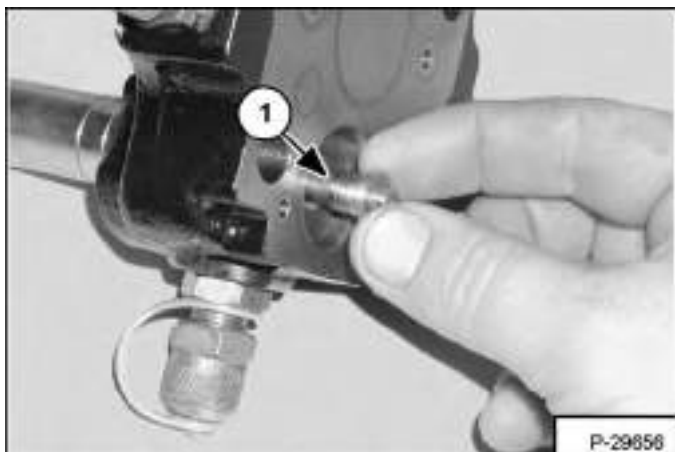

Remove the spool (Item 1) [Figure 30-30-7] from the housing.

Figure 30-30-8

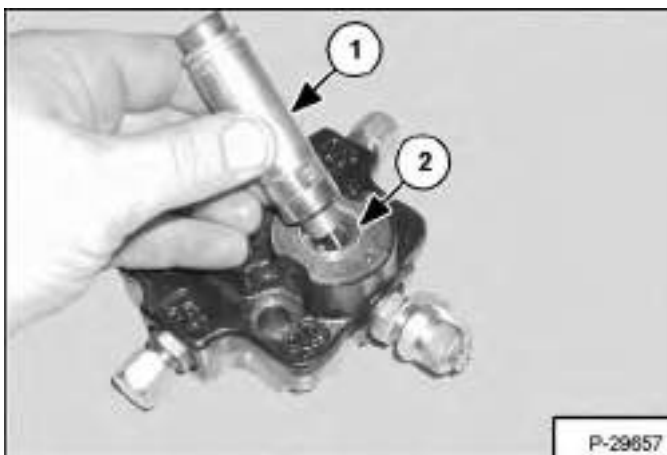

Remove the solenoid shaft (Item 1) and O-ring (Item 2) [Figure 30-30-8] from the housing.

Figure 30-30-9

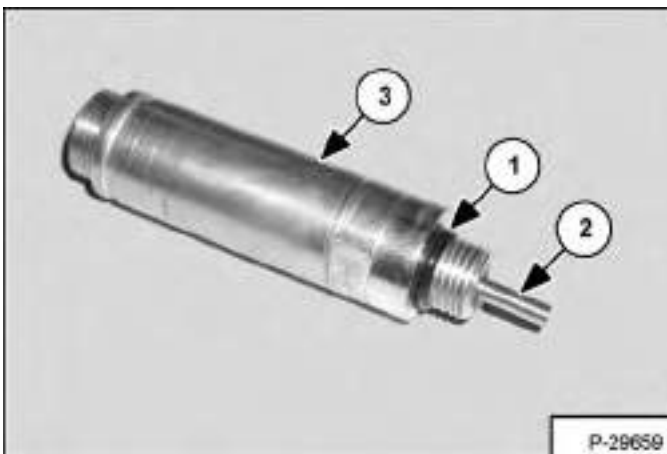

Remove the O-ring (Item 1) and pin (Item 2) from the solenoid shaft (Item 3) [Figure 30-30-9].

## HYDROSTATIC DRIVE MOTOR (CONT'D)

### Disassembly (Cont'd)

Figure 30-30-10

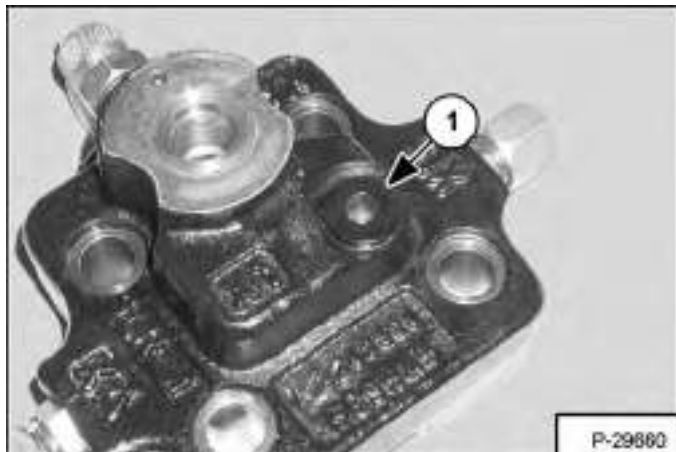

Remove the plug (Item 1) [Figure 30-30-10] from the housing.

Figure 30-30-11

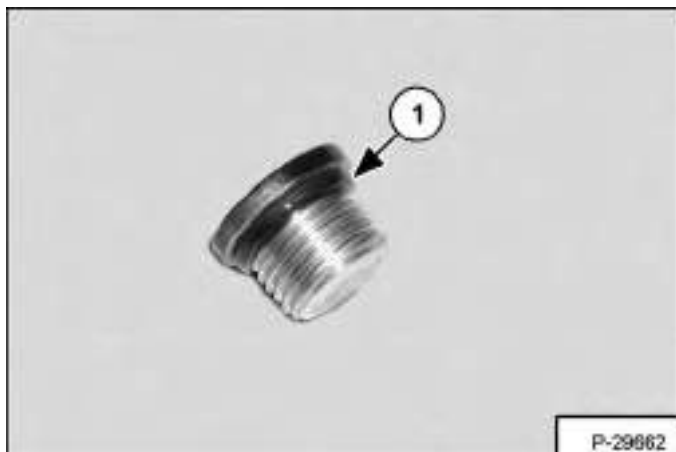

Remove and discard the O-ring (Item 1) [Figure 30-30-11] from the plug.

Figure 30-30-12

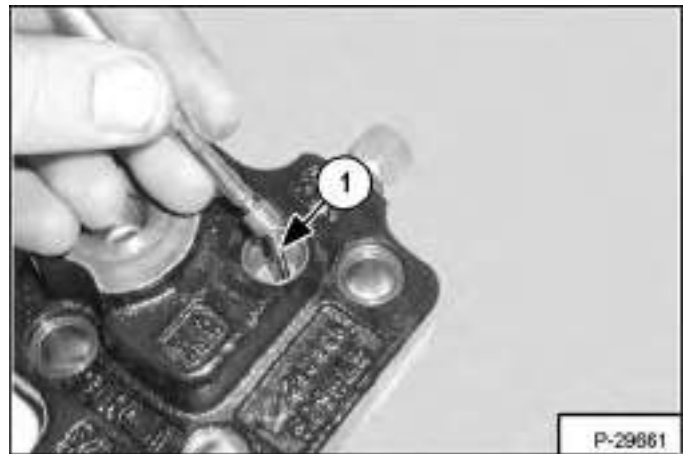

Remove the pin (Item 1) [Figure 30-30-12] from the housing.

Figure 30-30-13

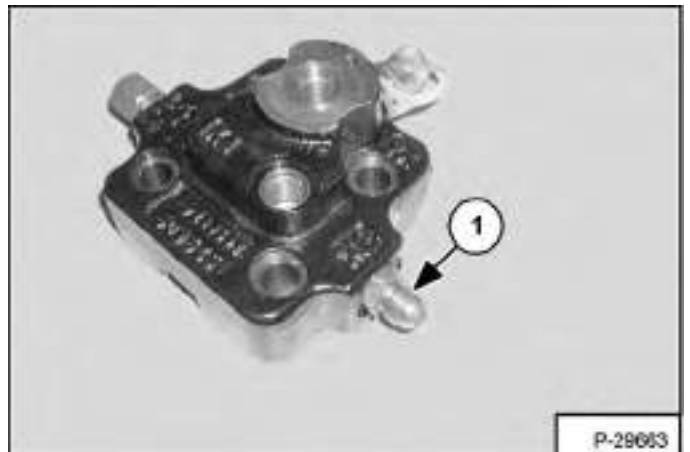

Remove the fitting (Item 1) [Figure 30-30-13].

## HYDROSTATIC DRIVE MOTOR (CONT'D)

### Disassembly (Cont'd)

Figure 30-30-14

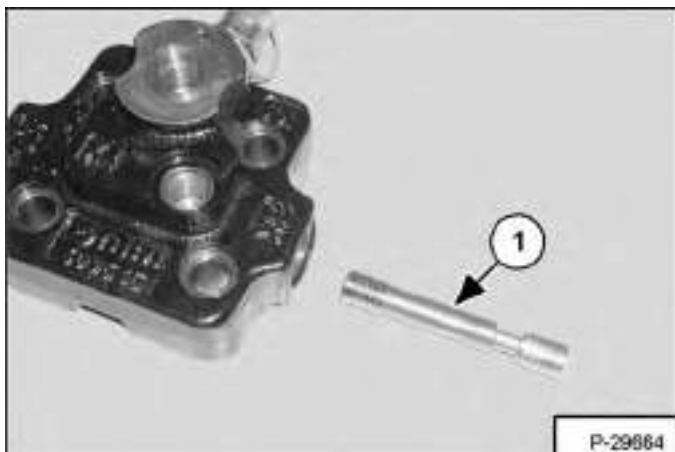

Remove the spool (Item 1) [Figure 30-30-14] from the housing.

Figure 30-30-15

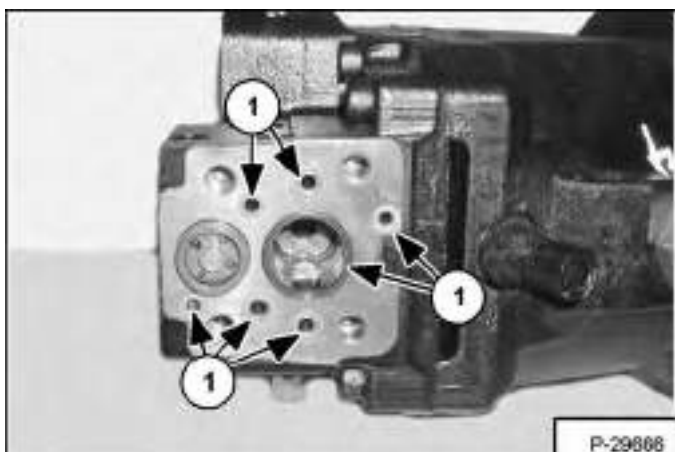

Remove and discard the seven O-rings (Item 1) [Figure 30-30-15] from the housing.

Figure 30-30-16

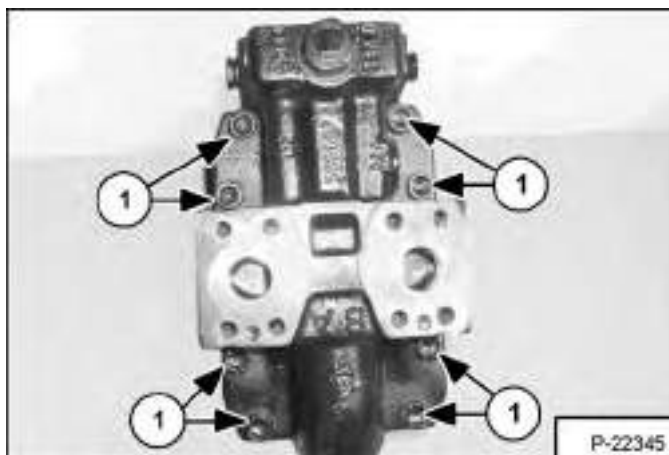

Remove the eight bolts (Item 1) [Figure 30-30-16] from the end cap.

Figure 30-30-17

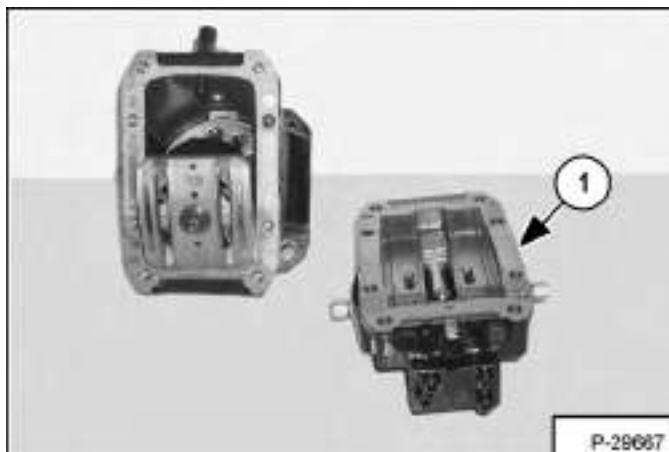

Lift and remove the end cap (Item 1) [Figure 30-30-17] from the housing.

## HYDROSTATIC DRIVE MOTOR (CONT'D)

### Disassembly (Cont'd)

Figure 30-30-18

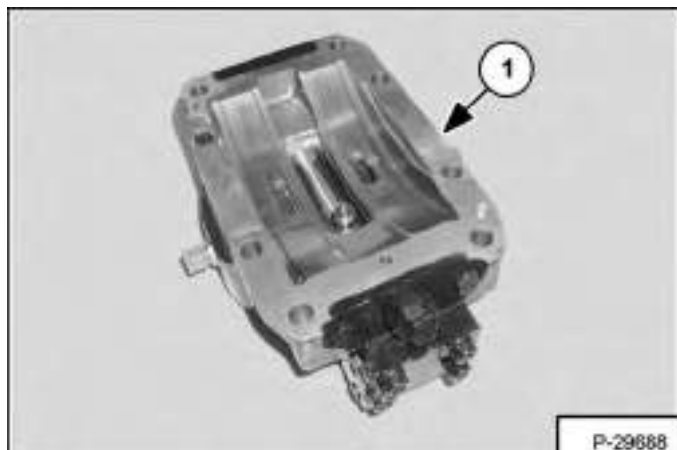

Remove the gasket (Item 1) [Figure 30-30-18] from the end cap.

Figure 30-30-19

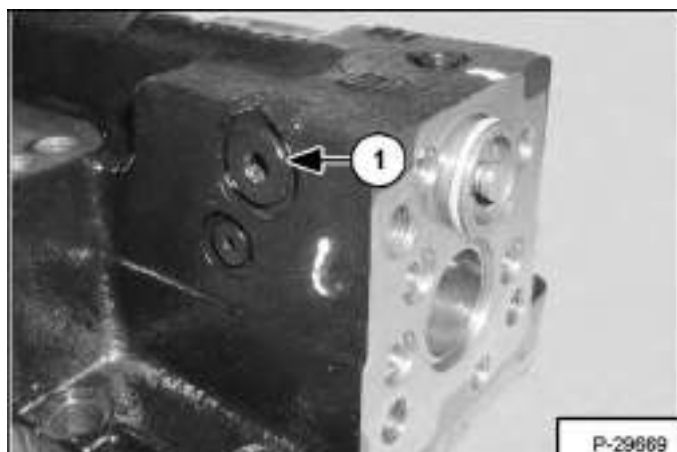

Remove the plug (Item 1) [Figure 30-30-19].

Figure 30-30-20

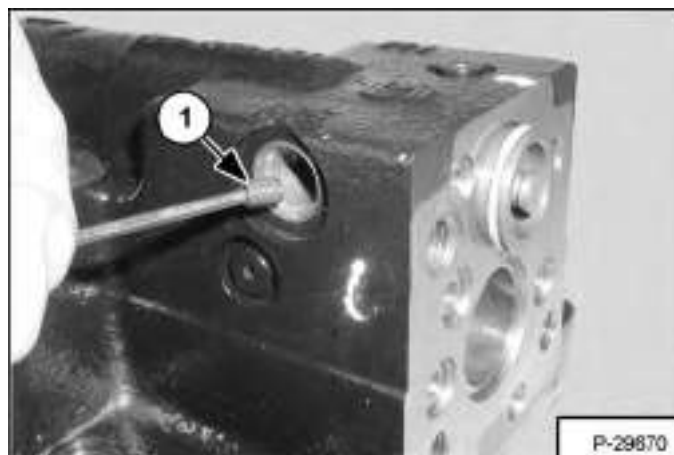

Remove the orifice (Item 1) [Figure 30-30-20].

**NOTE:** Mark the orifice location for correct assembly.

Figure 30-30-21



Remove the spool (Item 1) [Figure 30-30-21].

## HYDROSTATIC DRIVE MOTOR (CONT'D)

### Disassembly (Cont'd)

Figure 30-30-22

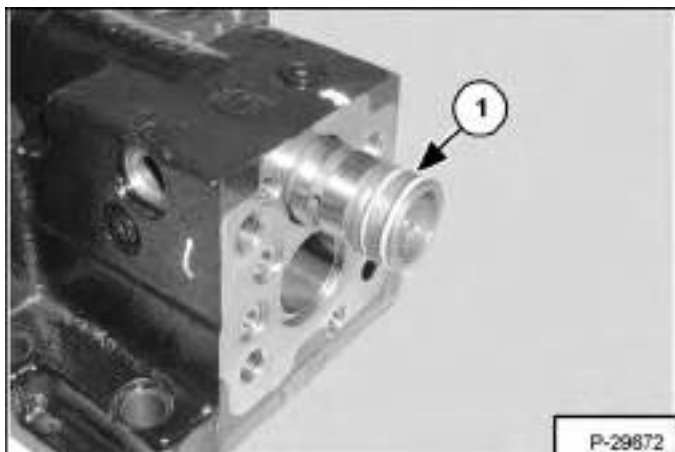

Remove the servo control spool (Item 1) [Figure 30-30-22] from the housing.

Figure 30-30-23

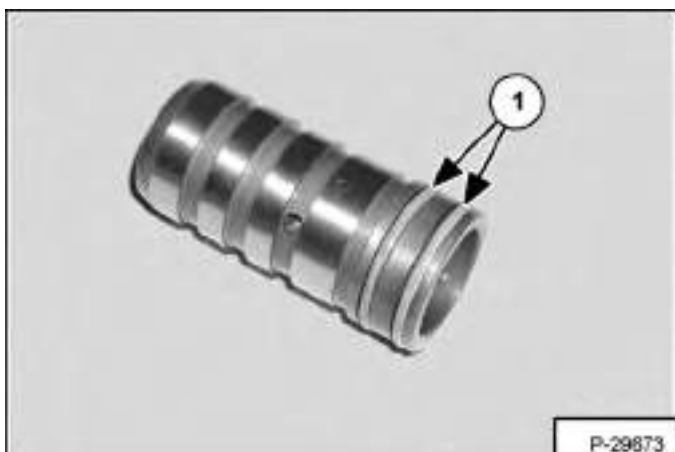

Remove the two O-rings (Item 1) [Figure 30-30-23] from the servo control spool.

Figure 30-30-24

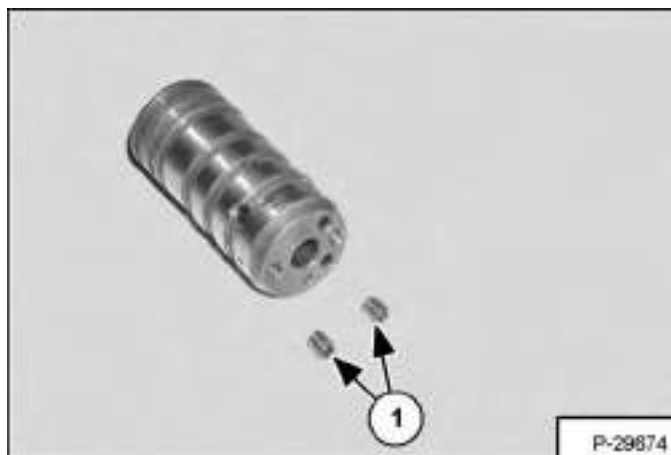

Remove the two orifices (Item 1) [Figure 30-30-24] from the spool.

**NOTE:** Mark the orifice location for correct assembly.

Figure 30-30-25

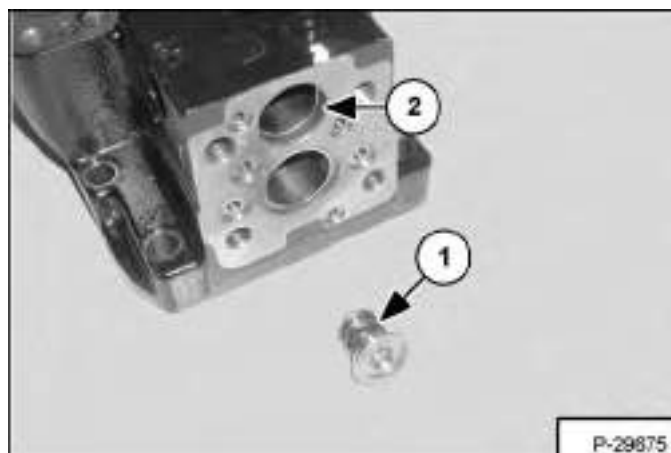

Remove the two spring seats and spring (Item 1) from the servo spool hole (Item 2) [Figure 30-30-25].

## HYDROSTATIC DRIVE MOTOR (CONT'D)

### Disassembly (Cont'd)

Figure 30-30-26

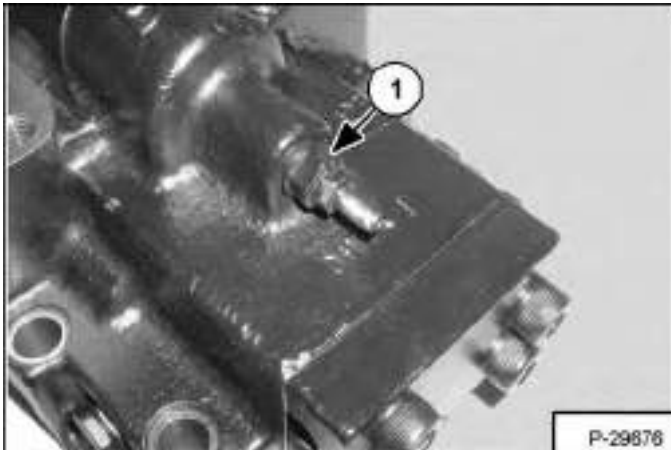

Loosen the large nut (Item 1) [Figure 30-30-26] on the adjustment screw.

**NOTE: Do not change the adjustment.**

Figure 30-30-27

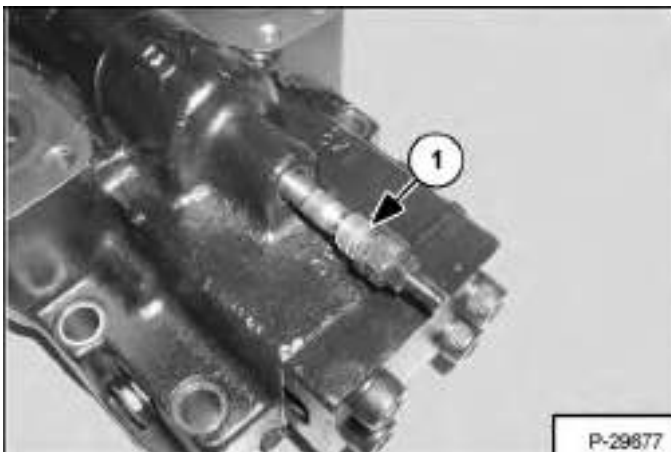

Remove the adjustment screw (Item 1) [Figure 30-30-27] from the housing.

Figure 30-30-28

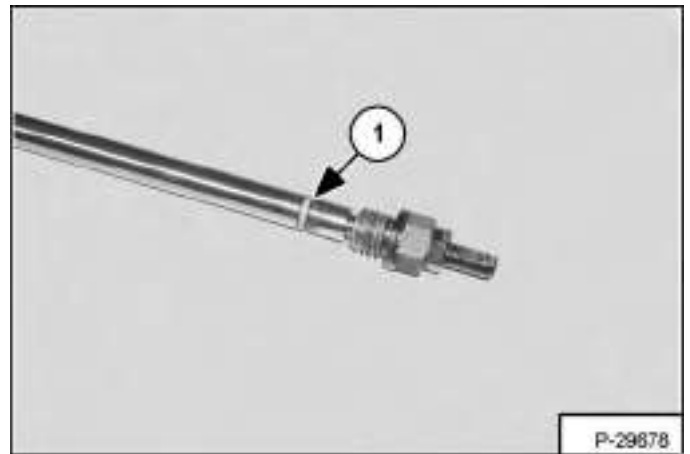

Remove and discard the O-ring (Item 1) [Figure 30-30-28].

Figure 30-30-29

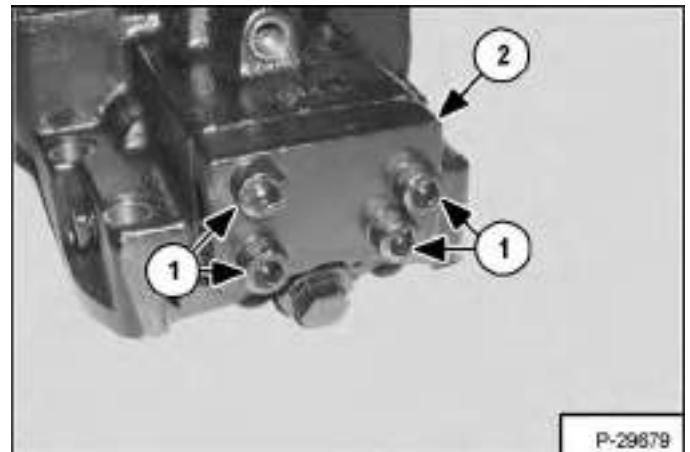

Remove the four bolts (Item 1) and remove the end cap (Item 2) [Figure 30-30-29].

## HYDROSTATIC DRIVE MOTOR (CONT'D)

### Disassembly (Cont'd)

Figure 30-30-30

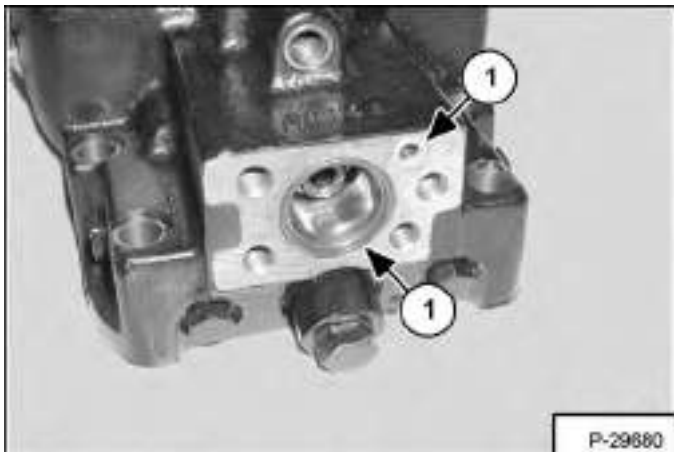

Remove the two O-rings (Item 1) [Figure 30-30-30].

Figure 30-30-31

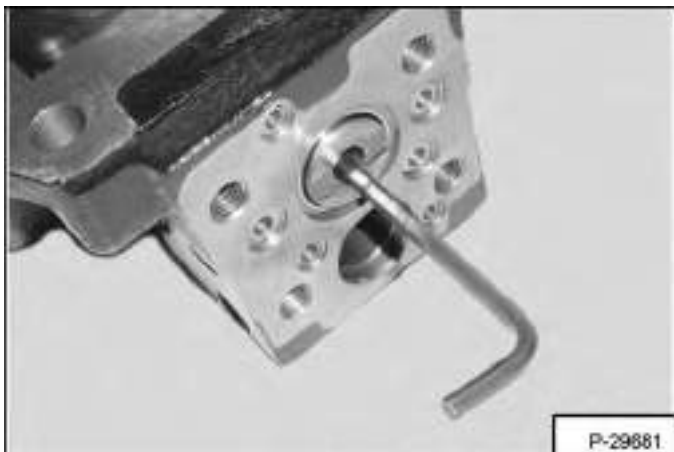

Remove the outer set screw from the servo piston [Figure 30-30-31].

Figure 30-30-32

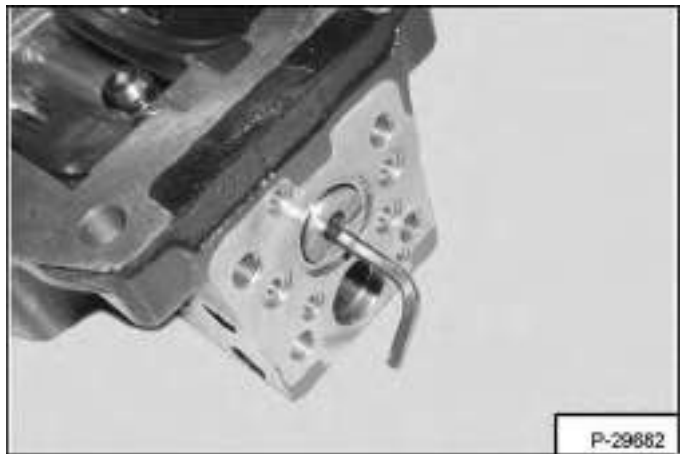

Remove the inner set screw from the servo piston [Figure 30-30-32].

Figure 30-30-33



Remove the feedback lug (Item 1) [Figure 30-30-33] from the servo piston.



## HYDROSTATIC DRIVE MOTOR (CONT'D)

### Disassembly (Cont'd)

Figure 30-30-34

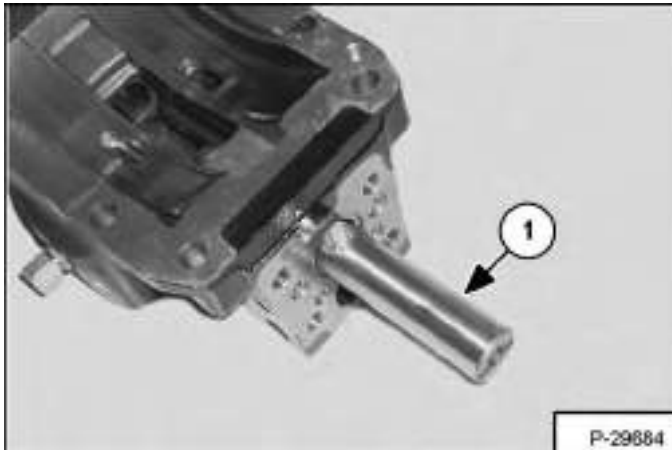

Remove the servo piston (Item 1) [Figure 30-30-34].

Figure 30-30-35

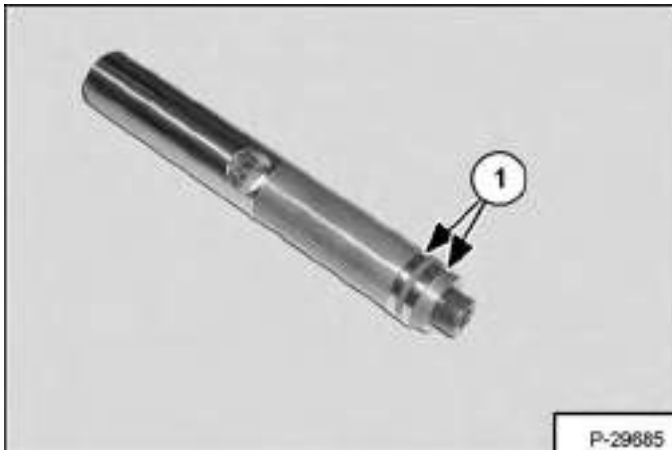

Remove the two seals (Item 1) [Figure 30-30-35] from the servo piston.

Figure 30-30-36

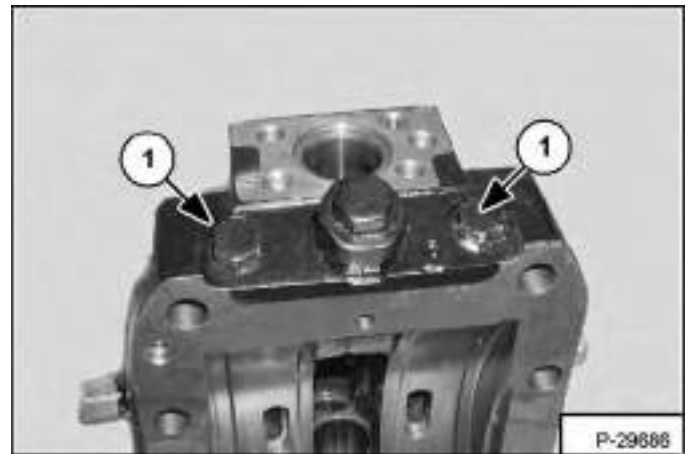

Remove the two plugs (Item 1) [Figure 30-30-36] from the housing.

Figure 30-30-37

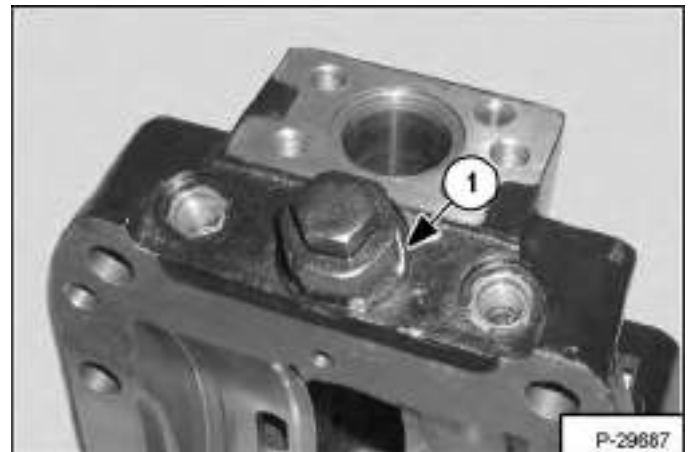

Remove the relief valve (Item 1) [Figure 30-30-37] from the housing by loosening the larger nut.

## HYDROSTATIC DRIVE MOTOR (CONT'D)

### Disassembly (Cont'd)

Figure 30-30-38

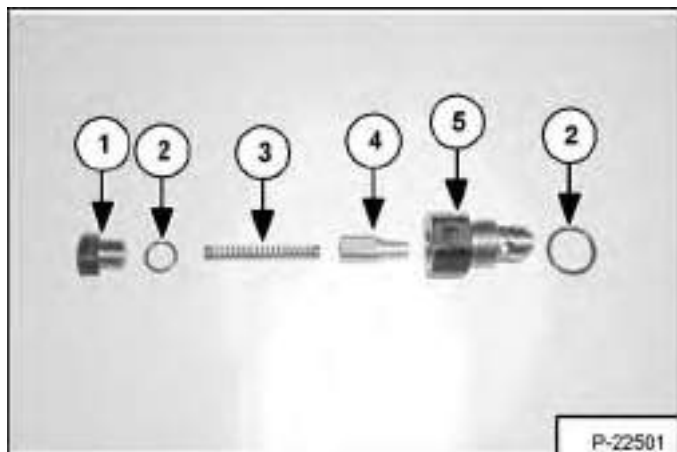

Remove the plug (Item 1), O-rings (Item 2), spring (Item 3) and poppet (Item 4) from the relief valve housing (Item 5) [Figure 30-30-38].

Figure 30-30-39

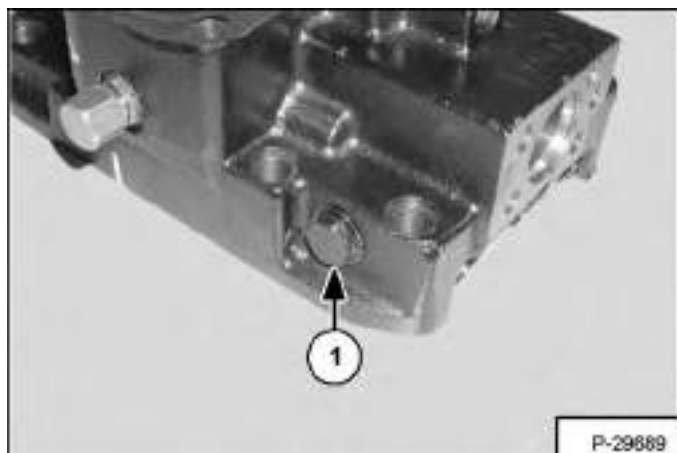

Loosen the plug (Item 1) [Figure 30-30-39].

Figure 30-30-40

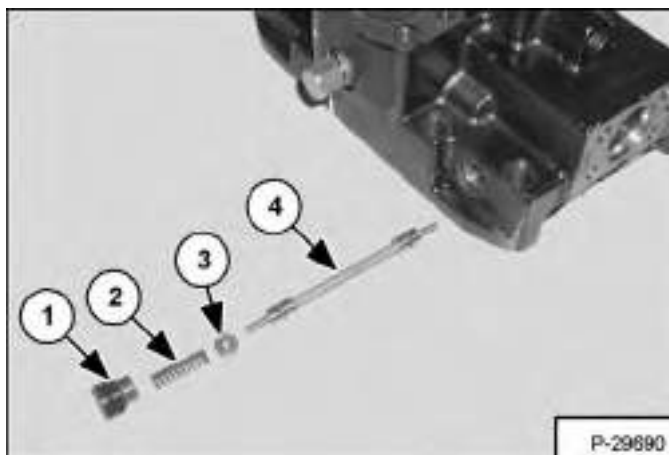

Remove the plug (Item 1), spring (Item 2), spring seat (Item 3) and spool (Item 4) [Figure 30-30-40] from the housing.

Figure 30-30-41

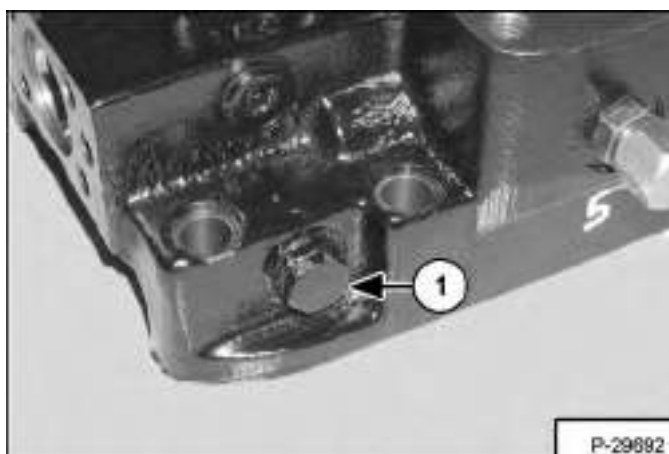

Loosen the plug (Item 1) [Figure 30-30-41].

## HYDROSTATIC DRIVE MOTOR (CONT'D)

### Disassembly (Cont'd)

Figure 30-30-42

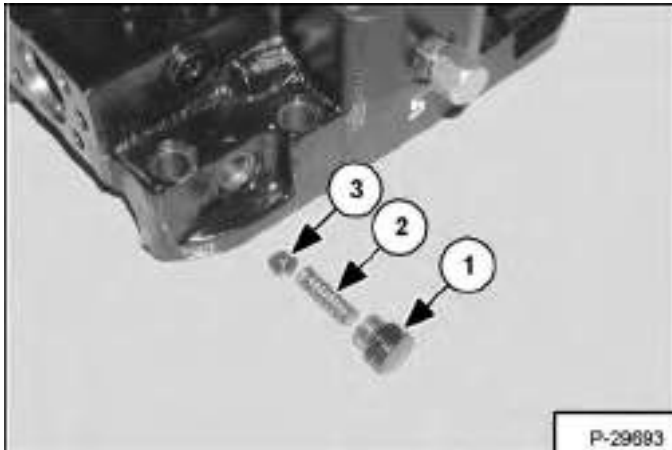

Remove the plug (Item 1), spring (Item 2) and spring seat (Item 3) [Figure 30-30-42] from the housing.

Figure 30-30-43

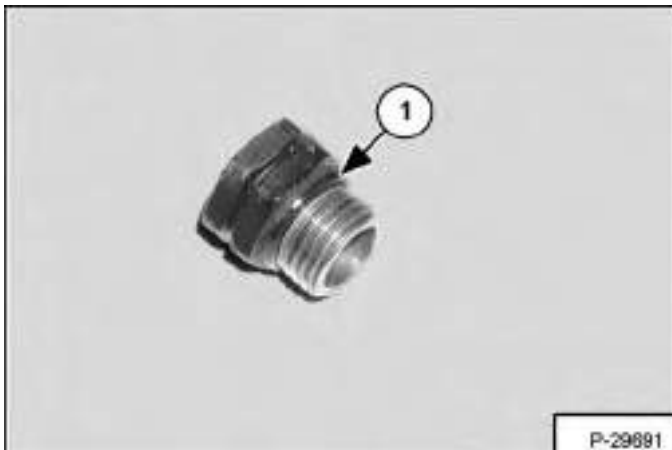

Remove and discard the O-ring (Item 1) [Figure 30-30-43] from the plug.

Figure 30-30-44

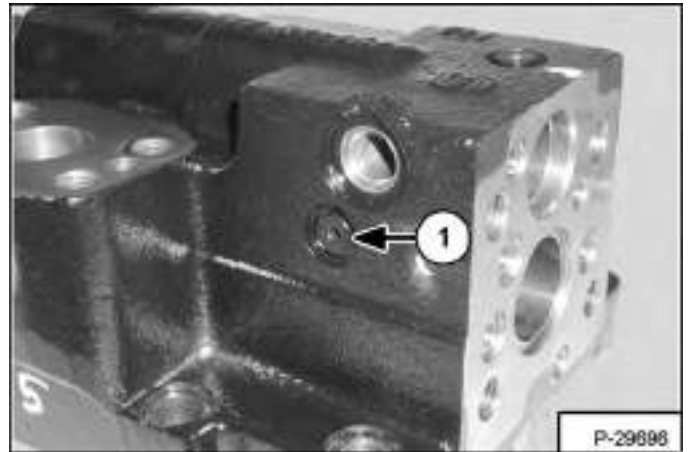

Remove the plug (Item 1) [Figure 30-30-44].

Figure 30-30-45

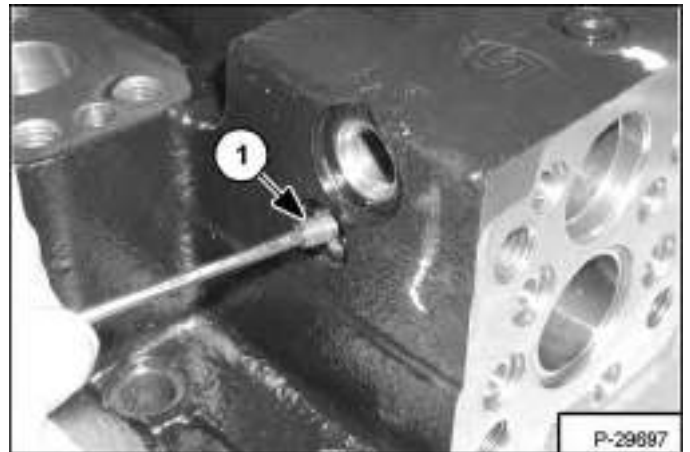

Remove the orifice (Item 1) [Figure 30-30-45].

**NOTE:** Mark the location of the orifice for correct assembly.

## HYDROSTATIC DRIVE MOTOR (CONT'D)

### Disassembly (Cont'd)

Figure 30-30-46

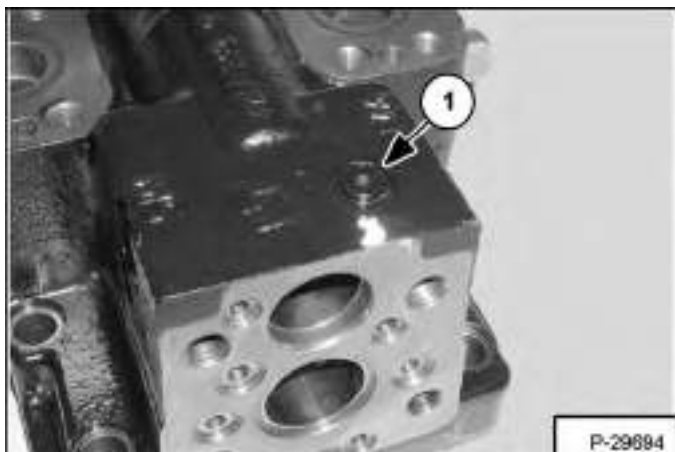

Remove the plug (Item 1) [Figure 30-30-46].

Figure 30-30-47

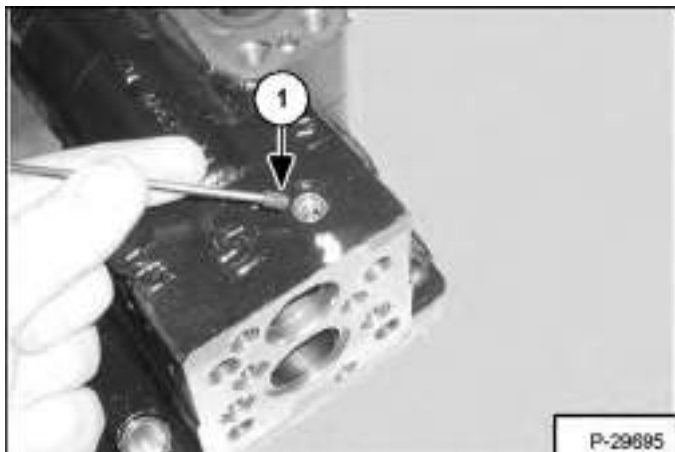

Remove the orifice (Item 1) [Figure 30-30-47].

**NOTE:** Mark the location of the orifice for correct assembly.

Figure 30-30-48

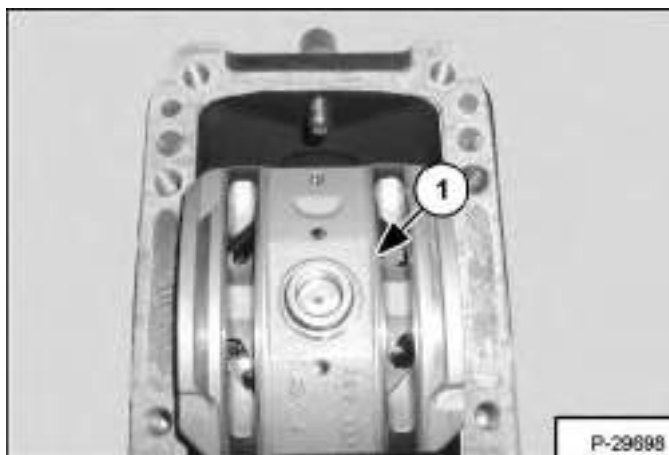

Remove the valve segment (Item 1) [Figure 30-30-48] from the cylinder.

Figure 30-30-49

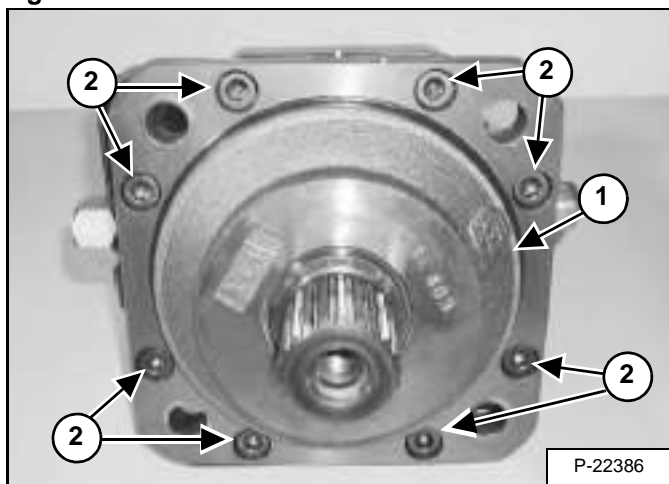

Remove and discard the O-ring (Item 1). Remove the eight mounting bolts (Item 2) [Figure 30-30-49] from the mounting plate.

## HYDROSTATIC DRIVE MOTOR (CONT'D)

### Disassembly (Cont'd)

Figure 30-30-50

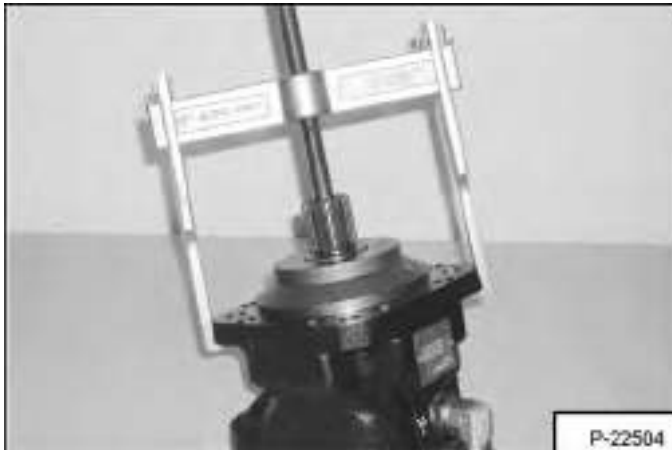

Remove the mounting plate [Figure 30-30-50] using a suitable puller.

Figure 30-30-51



Remove and discard the seal (Item 1) [Figure 30-30-51] from the mounting plate.

Figure 30-30-52

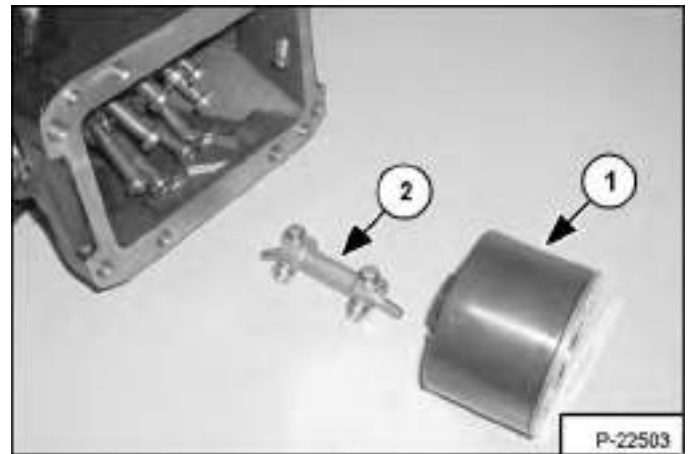

Remove the cylinder block (Item 1) and synchronizing shaft assembly (Item 2) [Figure 30-30-52] from the housing.

**NOTE:** It is not important that the pistons are installed in their original position.

Figure 30-30-53

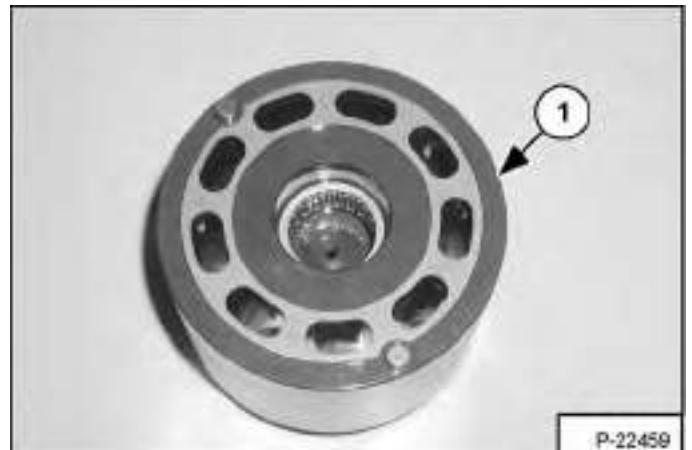

Remove the bearing plate (Item 1) [Figure 30-30-53] from the cylinder block.

## HYDROSTATIC DRIVE MOTOR (CONT'D)

### Disassembly (Cont'd)

Figure 30-30-54



Remove the bearing from the cylinder block [Figure 30-30-54].

DO NOT damage the bearing plate surface of the cylinder block.

Figure 30-30-55



Remove the O-ring (Item 1) [Figure 30-30-55] from the housing.

Figure 30-30-56

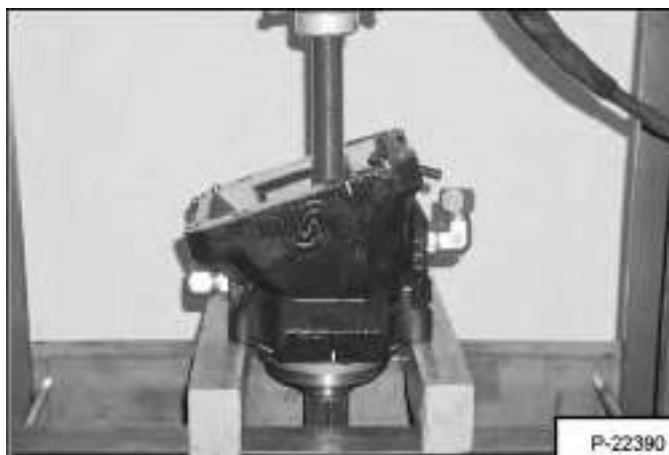

Press the piston / shaft assembly from the housing [Figure 30-30-56].

DO NOT damage the pistons.

Figure 30-30-57



Pry up the peened notch (Item 1) [Figure 30-30-57] in the ring nut.

## HYDROSTATIC DRIVE MOTOR (CONT'D)

### Disassembly (Cont'd)

Figure 30-30-58

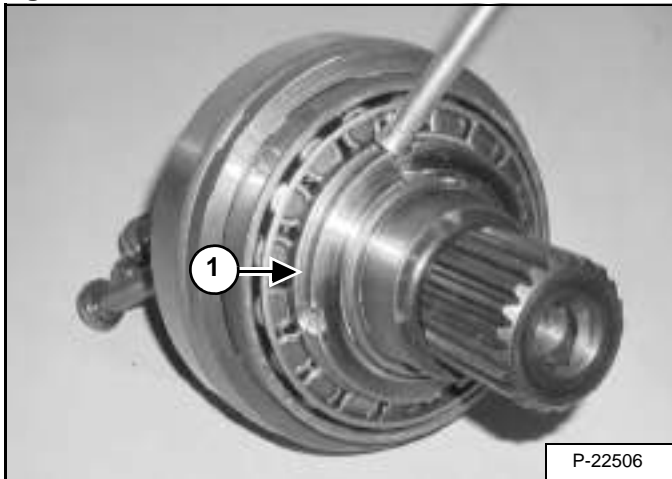

Remove the ring nut (Item 1) [Figure 30-30-58] from the shaft.

Figure 30-30-59

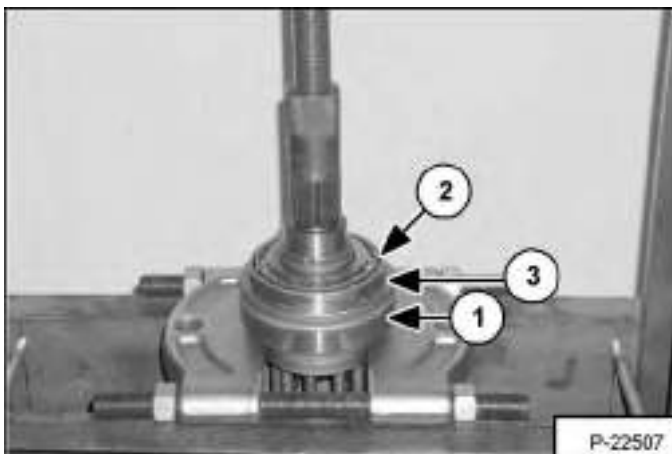

Remove the large bearing and race (Item 1), small bearing and race (Item 2) and spacer (Item 3) [Figure 30-30-59] from the shaft.

Figure 30-30-60

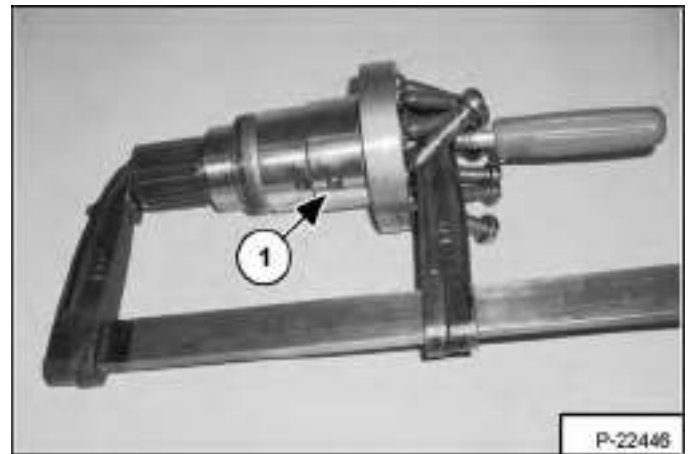

Using a clamp, compress the spring seat and spring, and drive the pin (Item 1) [Figure 30-30-60] inwards. Release the clamp.

Figure 30-30-61

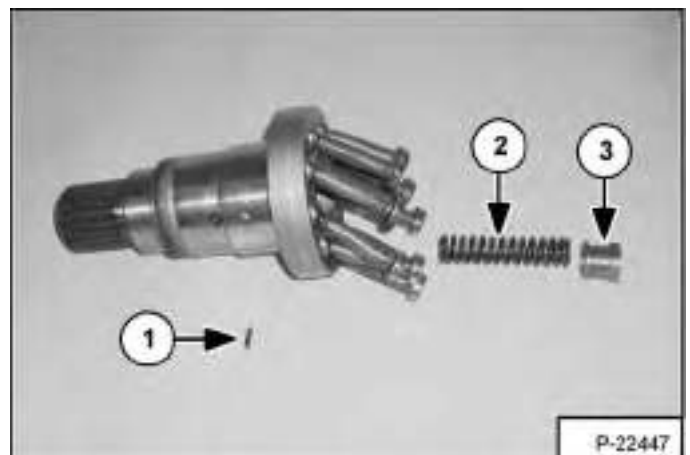

Remove the pin (Item 1), spring (Item 2) and spring seat (Item 3) [Figure 30-30-61] from the shaft assembly.

## HYDROSTATIC DRIVE MOTOR (CONT'D)

### Disassembly (Cont'd)

Figure 30-30-62

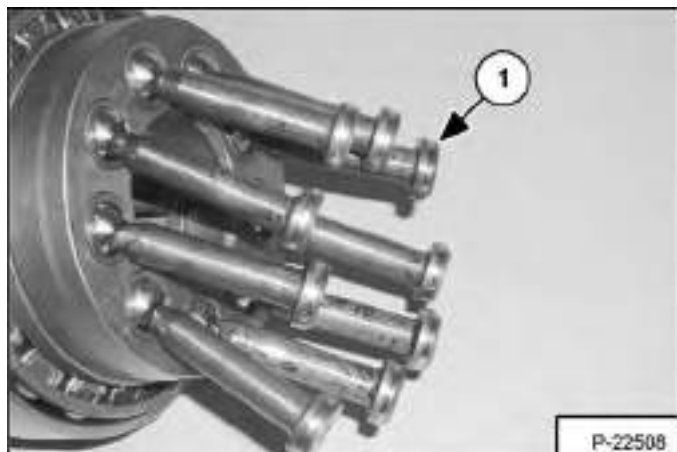

Remove the piston rings (Item 1) [Figure 30-30-62] from the pistons.

**NOTE:** If any portion of the shaft assembly, bearings or races must be replaced, the complete shaft / bearing assembly must be ordered. The only serviceable part is the piston rings (Item 1) [Figure 30-30-62].

### Inspection

Clean all parts in solvent and use air pressure to dry them. DO NOT use cloth or paper as small pieces of material can get into the system and cause damage.

Figure 30-30-63

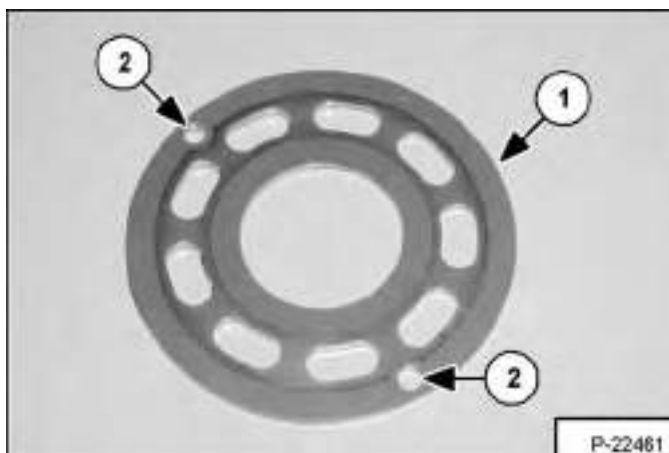

Inspect the running (bronze) surface of the bearing plate (Item 1) and locating pin holes (Item 2) [Figure 30-30-63] for wear. Replace if damaged or worn.

Figure 30-30-64

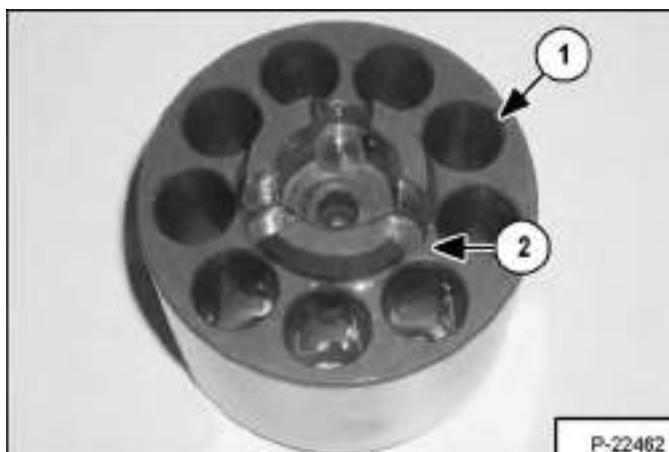

Inspect the cylinder block assembly for wear or damage. The piston bores (Item 1) must be smooth. The races for the synchronizing shaft rollers (Item 2) [Figure 30-30-64] must not be worn.

If there is any defect in the cylinder block or pistons, the complete rotating group must be replaced.



## HYDROSTATIC DRIVE MOTOR (CONT'D)

### Inspection (Cont'd)

Figure 30-30-65

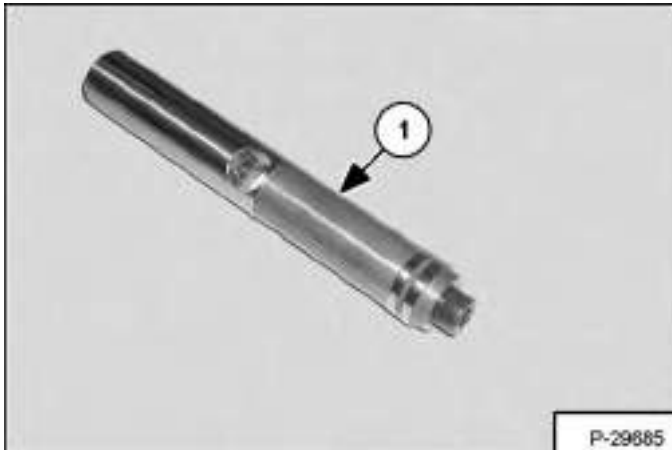

Inspect the piston (Item 1) [Figure 30-30-65] for wear or damage.

Figure 30-30-66



Inspect the swash plate running surface (Item 1) [Figure 30-30-66] in the end cap for wear or damage.

Figure 30-30-67

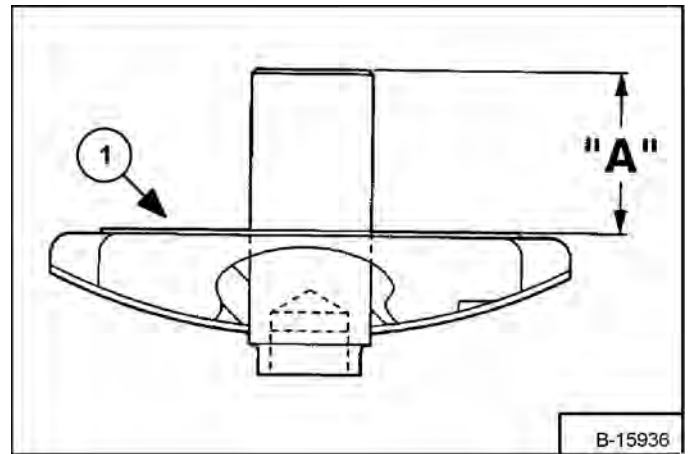

Inspect the valve segment for damage or wear on the sealing surface (Item 1) [Figure 30-30-67].

Check that the spindle is located correctly in the valve segment by measuring distance "A" [Figure 30-30-67]. If this dimension is not within 1.36 to 1.37 inch (34,5 to 34,7 mm) the assembly must be replaced.

## HYDROSTATIC DRIVE MOTOR (CONT'D)

### Assembly

# IMPORTANT

When repairing hydrostatic and hydraulic systems, clean the work area before disassembly and keep all parts clean. Always use caps and plugs on hoses, tubelines and ports to keep dirt out. Dirt can quickly damage the system.

I-2003-0888

Clean and lightly oil all parts prior to assembly.

Figure 30-30-68

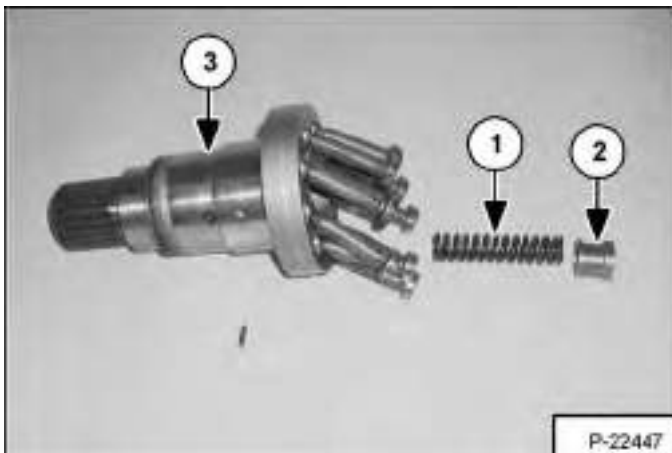

Install the spring (Item 1) and spring seat (Item 2) into the shaft assembly (Item 3) [Figure 30-30-68].

Figure 30-30-69



Using a clamp, compress the spring and spring seat [Figure 30-30-69].

Figure 30-30-70

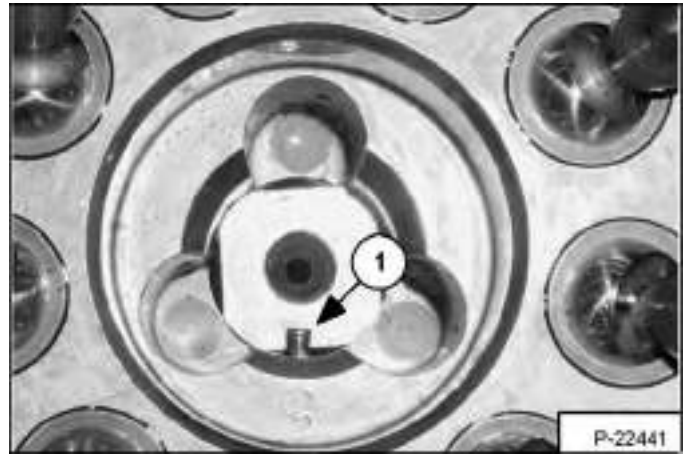

Install the pin (Item 1) [Figure 30-30-70] as shown.

**NOTE:** Clamp is removed for photo clarity.

Figure 30-30-71

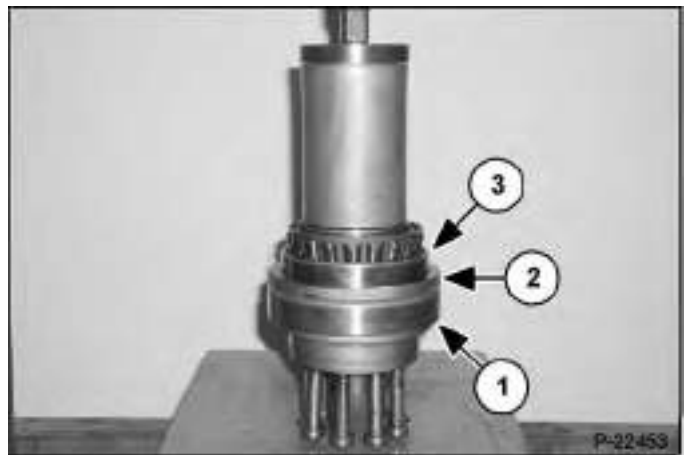

Support the shaft assembly in a press without causing damage to the pistons, install the large bearing and race (Item 1), spacer (Item 2) and small bearing and race (Item 3) [Figure 30-30-71] into the shaft assembly.

**NOTE:** Be sure not to over press the bearings, they should be able to roll freely.

## HYDROSTATIC DRIVE MOTOR (CONT'D)

### Assembly (Cont'd)

Figure 30-30-72



Install the ring nut (Item 1) [Figure 30-30-72] onto the shaft.

**NOTE: Do not over tighten the ring nut and that there is no noticeable looseness in the bearing.**

Figure 30-30-73



Using a punch seat the ring nut into the groove in the shaft. [Figure 30-30-73].

Figure 30-30-74



Press the piston / shaft assembly into the housing [Figure 30-30-74].

DO NOT DAMAGE THE PISTONS.

Figure 30-30-75

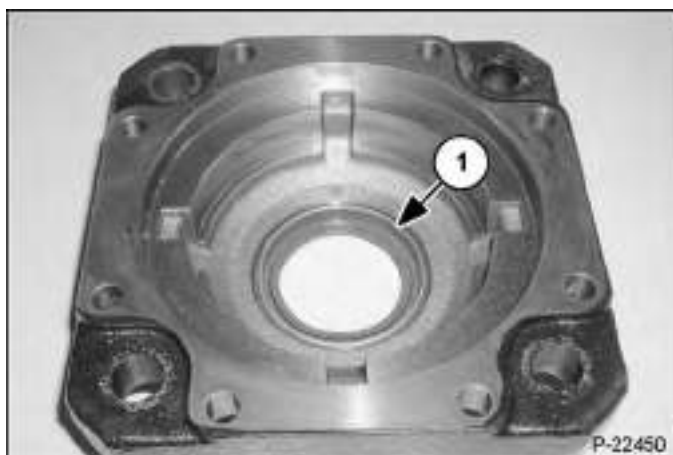

Install a new seal (Item 1) [Figure 30-30-75] into the mounting plate until it is fully seated.

## HYDROSTATIC DRIVE MOTOR (CONT'D)

### Assembly (Cont'd)

Figure 30-30-76



Install a new O-ring (Item 1) [Figure 30-30-76] onto the housing.

Figure 30-30-77

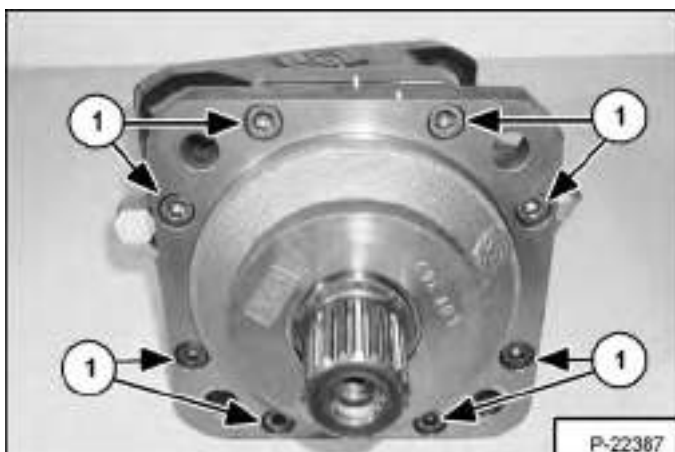

Install the mounting plate onto the housing, install the eight mounting bolts (Item 1) [Figure 30-30-77] and tighten to 46 ft.-lb. (63 N•m) torque.

Figure 30-30-78



Install a new O-ring (Item 1) [Figure 30-30-78] onto the mounting plate.

Figure 30-30-79

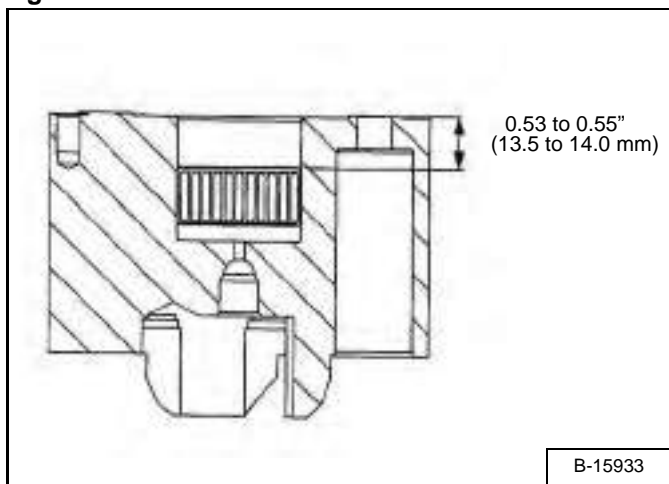

Press a new bearing into the cylinder block until it is located 0.53 to 0.55 inch (13,5 to 14,0 mm) below the bearing plate surface [Figure 30-30-79].

## HYDROSTATIC DRIVE MOTOR (CONT'D)

### Assembly (Cont'd)

Figure 30-30-80

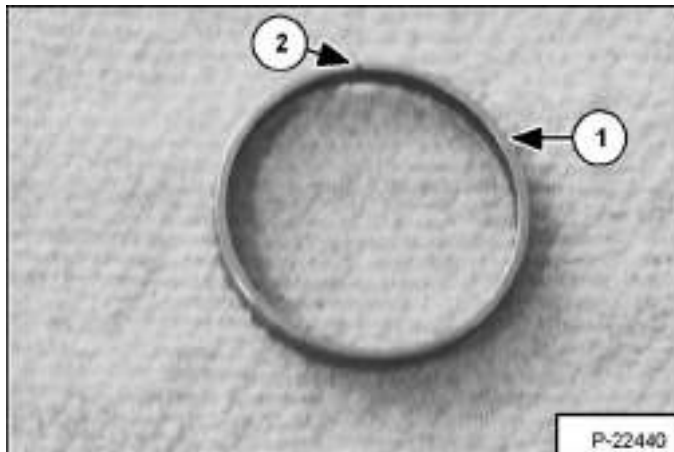
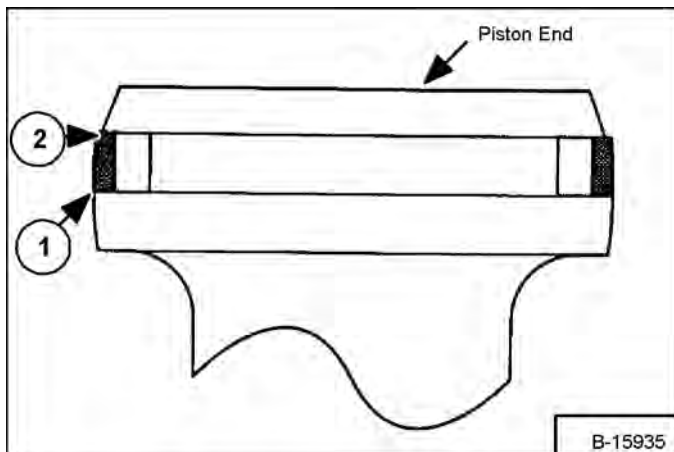

Figure 30-30-81



Install new piston rings (Item 1) [Figure 30-30-80] onto the pistons, make sure the spherical surface (Item 1) [Figure 30-30-81] conforms to the shape of the piston.

An identification mark (Item 2) [Figure 30-30-80] & [Figure 30-30-81] is on the "outer" side of the piston ring.

The ends of the piston rings must NOT overlap each other.

Figure 30-30-82

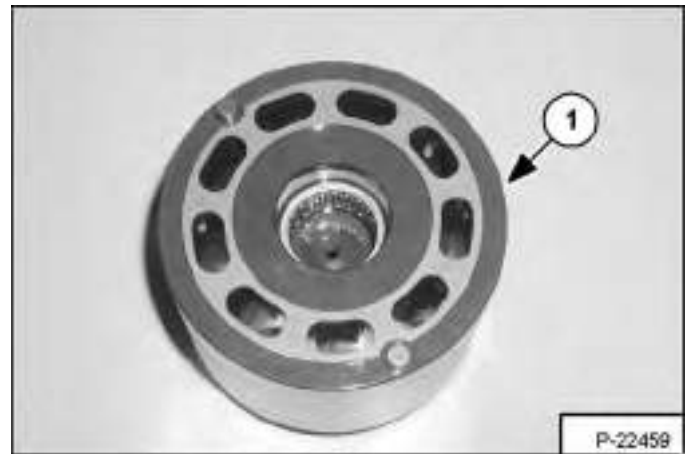

Install the bearing plate (Item 1) [Figure 30-30-82] with the bronze surface facing up onto the cylinder block.

Figure 30-30-83

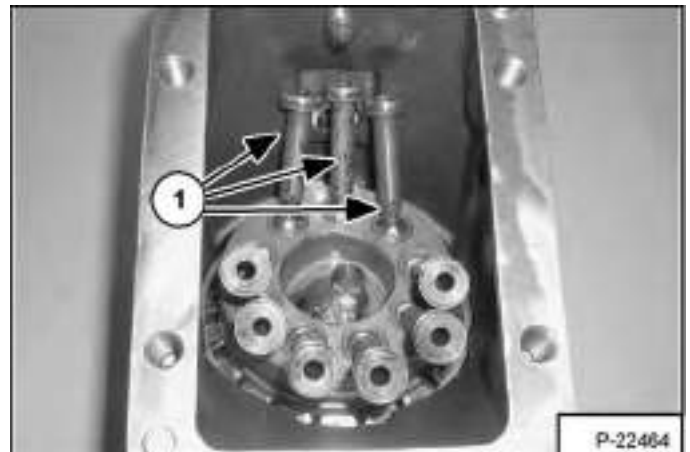

Position the housing on end, tip the three pistons (Item 1) [Figure 30-30-83] closest to the minimum angle stop out toward the housing.

## HYDROSTATIC DRIVE MOTOR (CONT'D)

### Assembly (Cont'd)

Figure 30-30-84

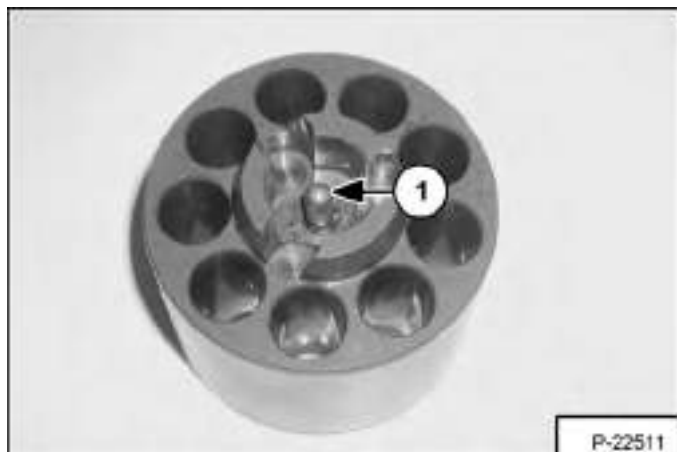

Install the synchronizing shaft support pin (Item 1) [Figure 30-30-84] into the cylinder block and retain with grease.

Figure 30-30-85

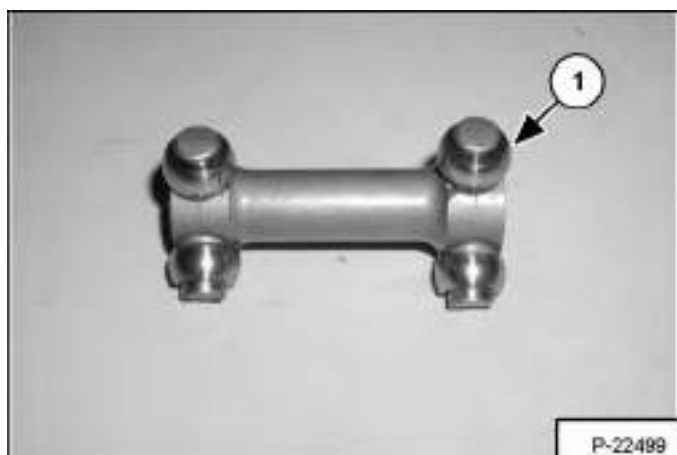

Install the six synchronizing shaft rollers (Item 1) [Figure 30-30-85] onto the synchronizing shaft and retain with grease.

Figure 30-30-86

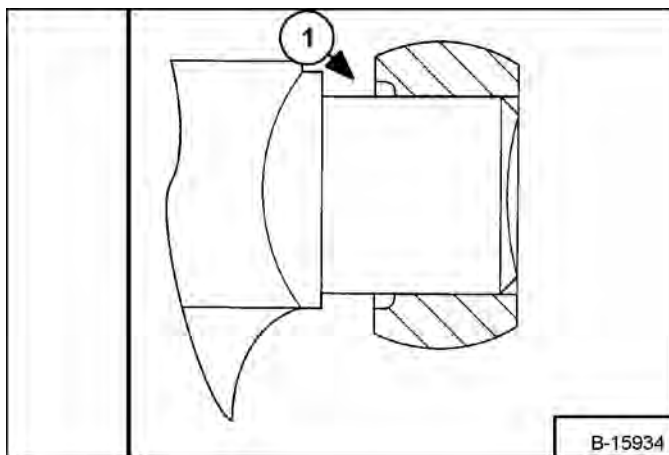

**NOTE:** The recess (Item 1) [Figure 30-30-86] on each roller **MUST** face the synchronizing shaft.

Figure 30-30-87

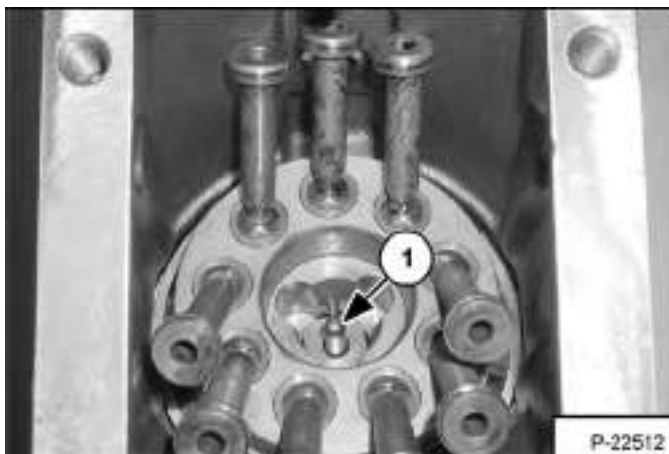

Install the synchronizing shaft support pin (Item 1) [Figure 30-30-87] into the motor shaft assembly and retain with grease.

## HYDROSTATIC DRIVE MOTOR (CONT'D)

### Assembly (Cont'd)

Figure 30-30-88

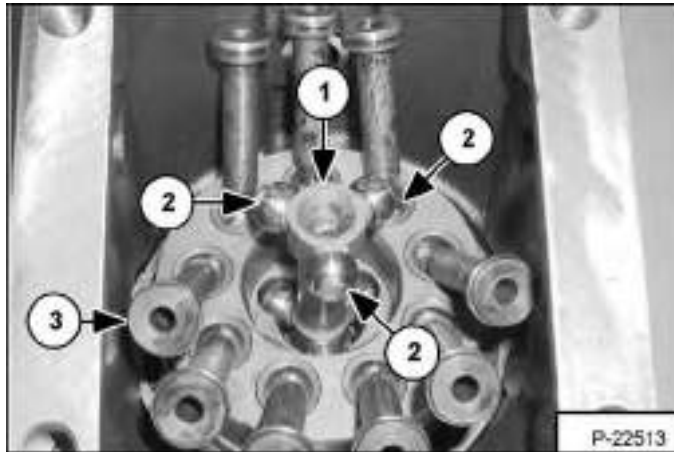

Install the synchronizing shaft and rollers (Item 1) [Figure 30-30-88] into the motor shaft races. When properly installed the synchronizing shaft should move freely in all directions.

**NOTE: The motor shaft end of the synchronizing shaft is smaller than the cylinder end.**

Figure 30-30-89

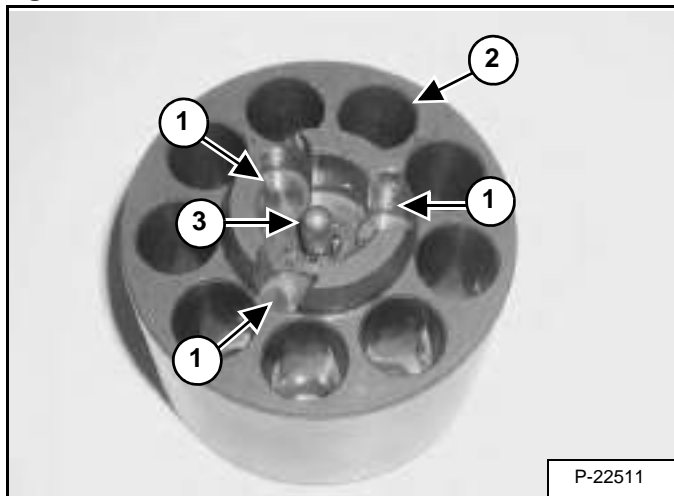

When installing the cylinder block, the races (Item 1) in the cylinder block must be positioned so the synchronizing shaft rollers (Item 2) and pistons (Item 3) and their bores (Item 2) [Figure 30-30-89] are aligned.

Install the six pistons (Item 3) into the cylinder bores, tilt the block so the synchronizing shaft rollers enter their races in the block and the support pin (Item 3) [Figure 30-30-89] enter the recess.

Lift the cylinder block slightly and guide the three remaining pistons in position.

Figure 30-30-90

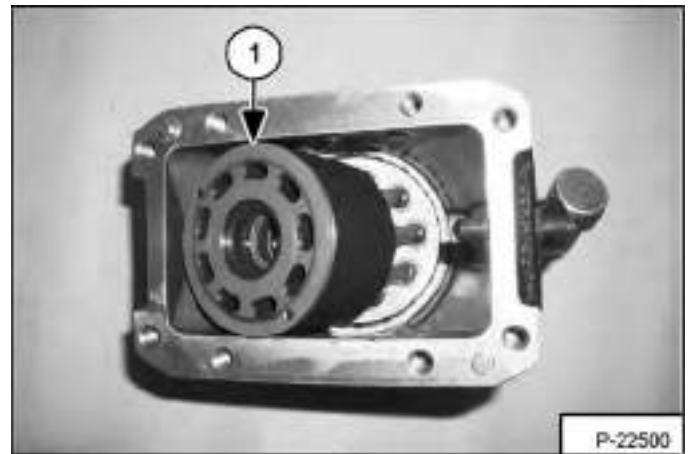

If the cylinder block (Item 1) [Figure 30-30-90] is properly installed, there should be very little rotational free-play between the block and the motor shaft.

**NOTE: A brass rod may be used to guide the pistons into their bores.**

Lubricate the pistons and cylinder block bores with hydraulic oil.

Figure 30-30-91

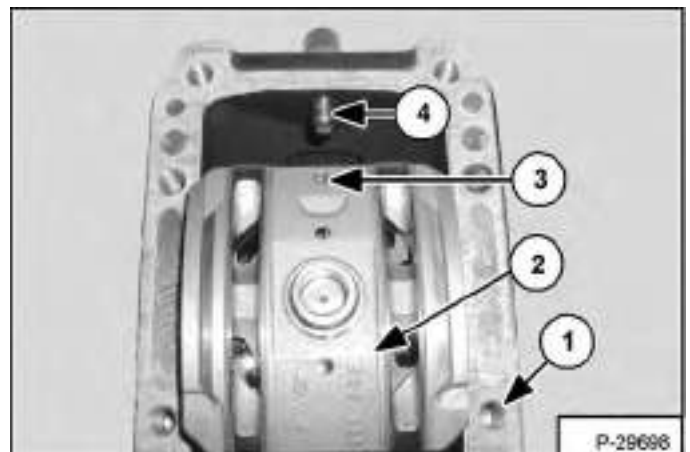

Install a new gasket (Item 1) [Figure 30-30-91] onto the housing.

Install the valve segment (Item 2) [Figure 30-30-91] onto the cylinder block and retain with heavy grease.

**NOTE: The hole (Item 3) in the valve segment should be next to the minimum displacement adjustment screw (Item 4) [Figure 30-30-91].**

## HYDROSTATIC DRIVE MOTOR (CONT'D)

### Assembly (Cont'd)

Figure 30-30-92

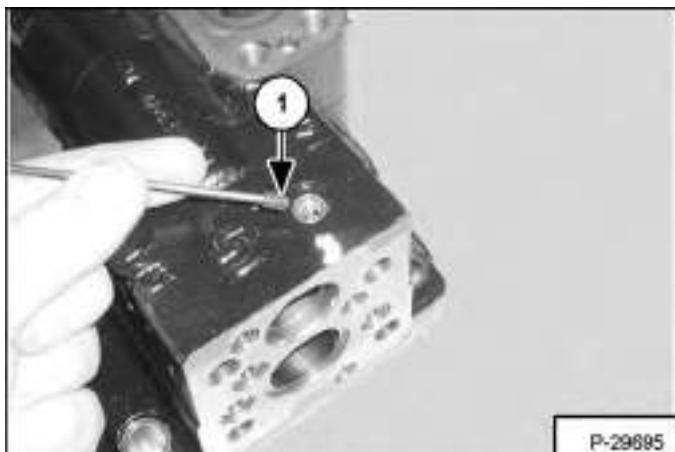

Install the orifice (Item 1) [Figure 30-30-92] and tighten to 4 ft.-lb. (5 N•m) torque.

Figure 30-30-93

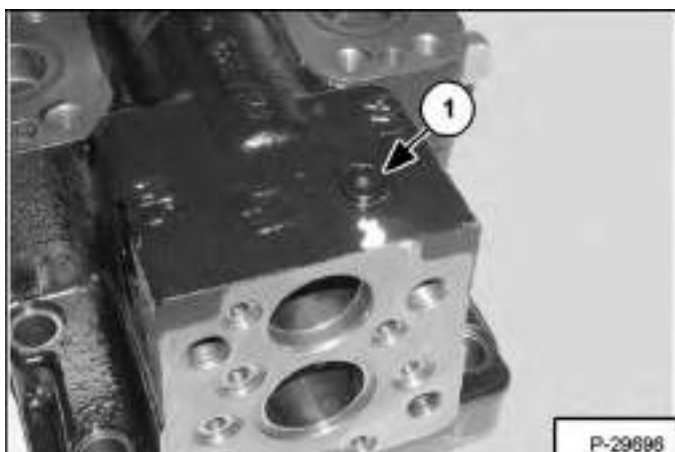

Install the plug (Item 1) [Figure 30-30-93] and tighten to 4 ft.-lb. (5 N•m) torque.

Figure 30-30-94

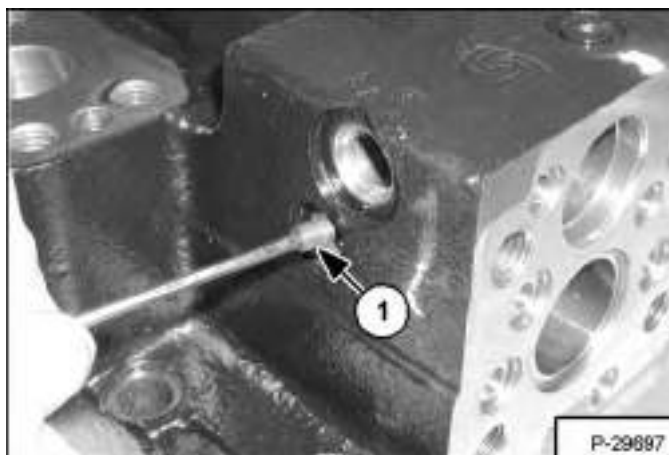

Install the orifice (Item 1) [Figure 30-30-94] and tighten to 4 ft.-lb. (5 N•m) torque.

Figure 30-30-95

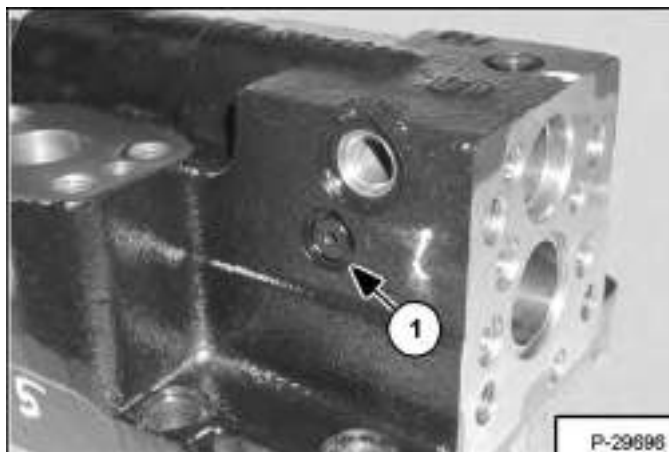

Install the plug (Item 1) [Figure 30-30-95] and tighten to 4 ft.-lb. (5 N•m) torque.



## HYDROSTATIC DRIVE MOTOR (CONT'D)

### Assembly (Cont'd)

Figure 30-30-96

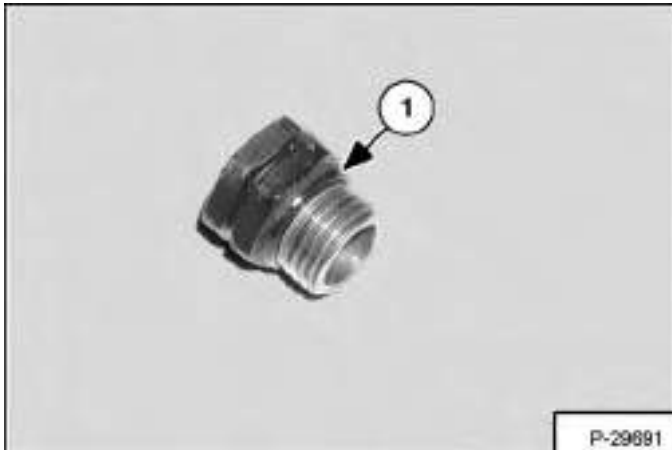

Install a new O-ring (Item 1) [Figure 30-30-96] on the plug.

Figure 30-30-97

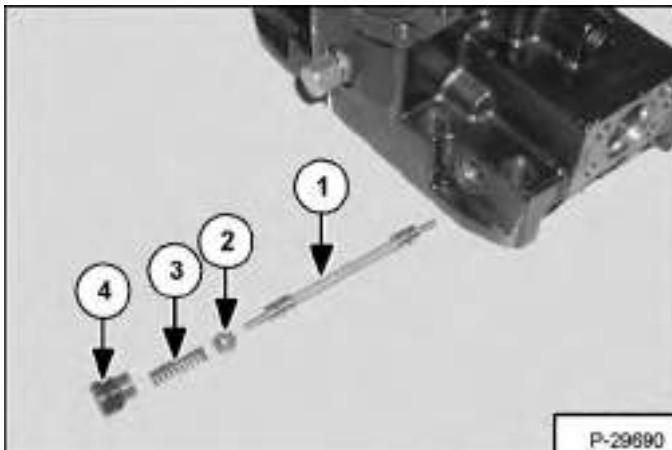

Install the spool (Item 1), spring seat (Item 2), spring (Item 3) and plug (Item 4) [Figure 30-30-97] into the housing and tighten to 30 ft.-lb. (41 N•m) torque.

Figure 30-30-98

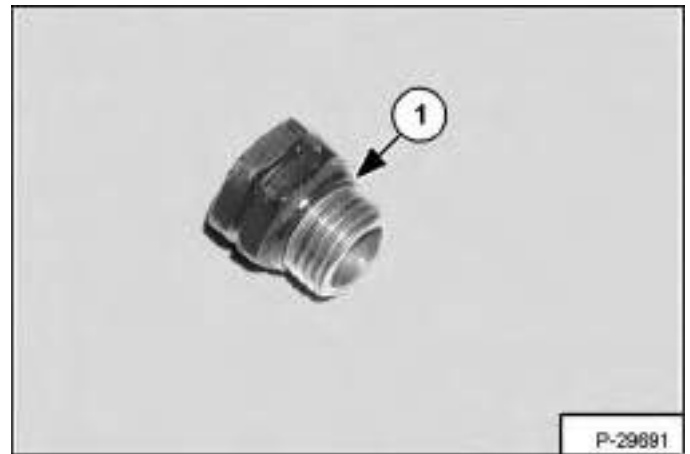

Install a new O-ring (Item 1) [Figure 30-30-98] on the plug.

Figure 30-30-99

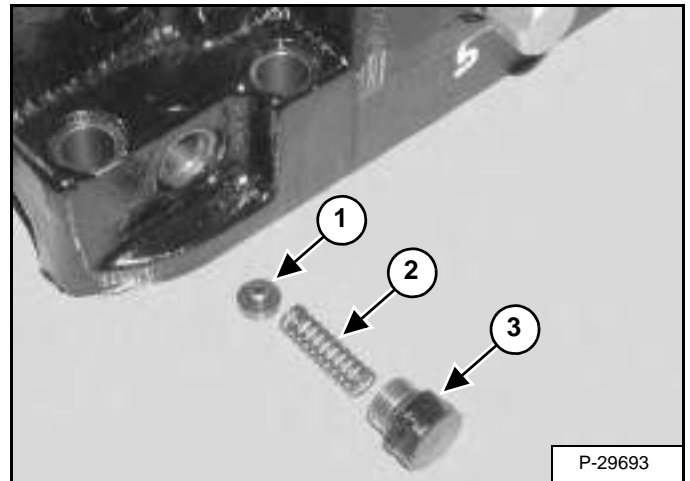

Install the spring seat (Item 1), spring (Item 2) and plug (Item 3) [Figure 30-30-99] into the housing and tighten to 30 ft.-lb. (41 N•m) torque.

## HYDROSTATIC DRIVE MOTOR (CONT'D)

### Assembly (Cont'd)

Figure 30-30-100

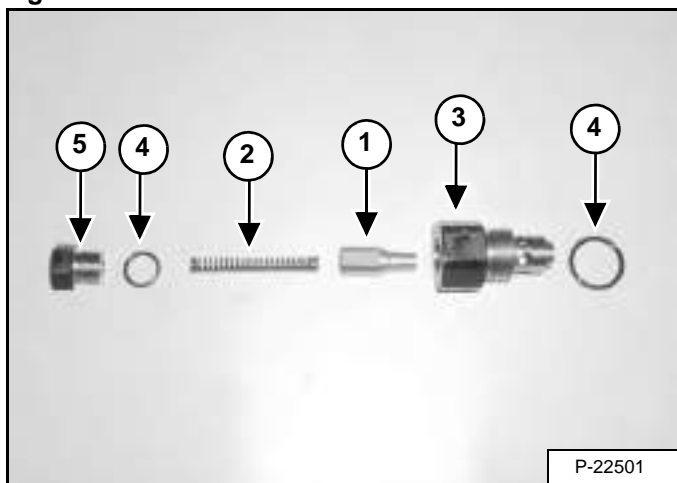

Assemble the poppet (Item 1) and spring (Item 2) into the relief valve housing (Item 3) using new O-rings (Item 4) and plug (Item 5) [Figure 30-30-100].

Figure 30-30-101

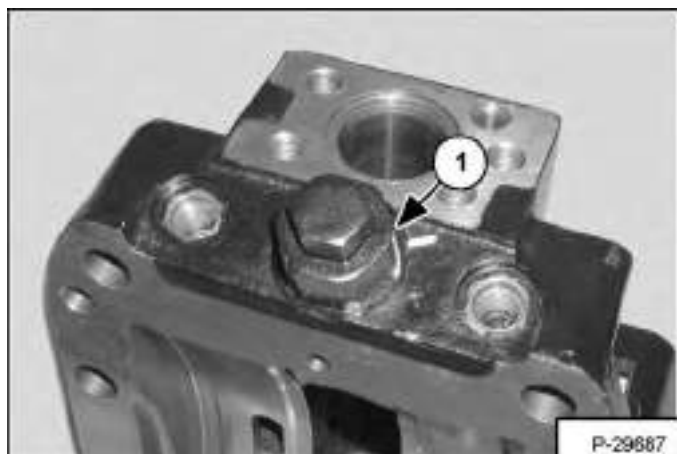

Install the relief valve (Item 1) [Figure 30-30-101] into the housing and tighten to 38 ft.-lb. (52 N•m) torque.

Figure 30-30-102

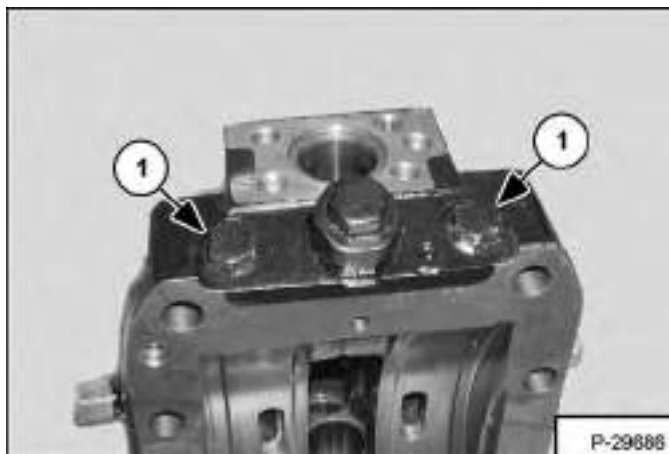

Install the two plugs (Item 1) [Figure 30-30-102] and tighten to 30 ft.-lb. (41 N•m) torque.

Figure 30-30-103

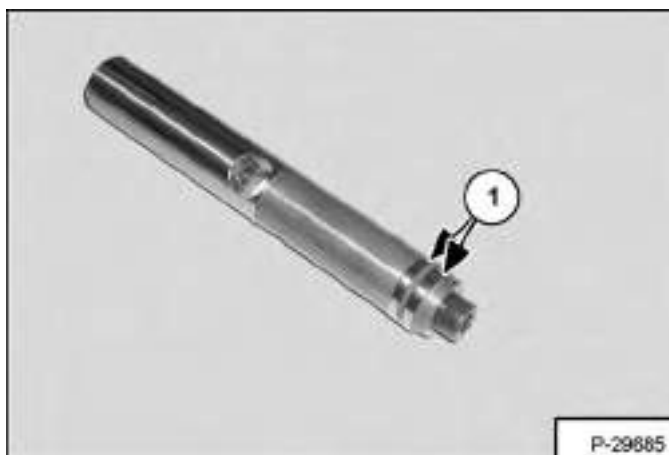

Install the two seals (Item 1) [Figure 30-30-103] onto the servo piston.

## HYDROSTATIC DRIVE MOTOR (CONT'D)

### Assembly (Cont'd)

Figure 30-30-104

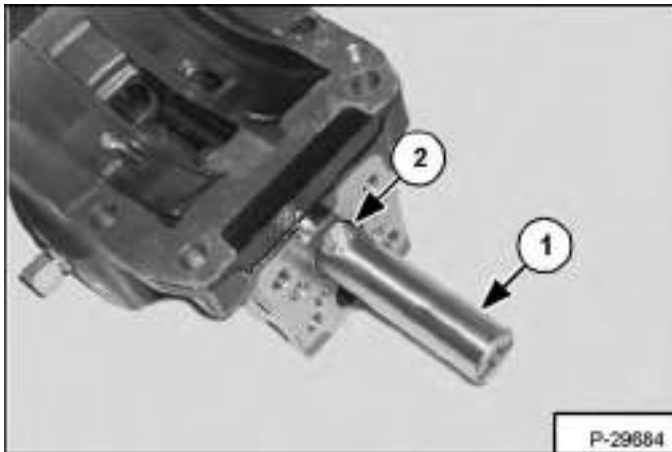

Install the servo piston (Item 1) into the housing, make sure the hole (Item 2) [Figure 30-30-104] is in the position shown when the piston is fully installed.

Figure 30-30-105

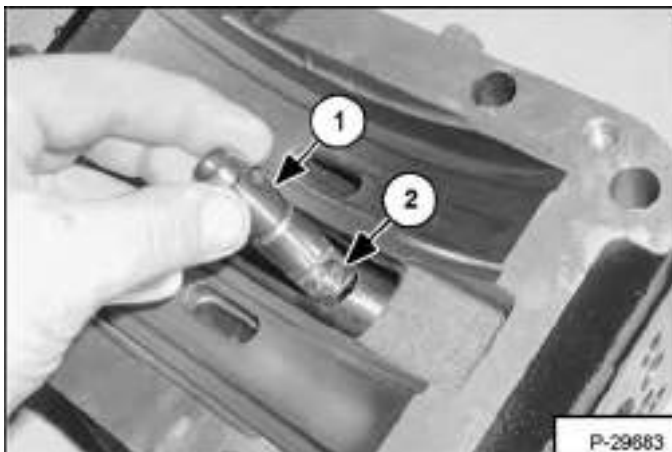

Install the feed back lug (Item 1) [Figure 30-30-105] into the servo piston.

**NOTE:** The position of the flat side of the feed back lug (Item 2) [Figure 30-30-105].

Figure 30-30-106

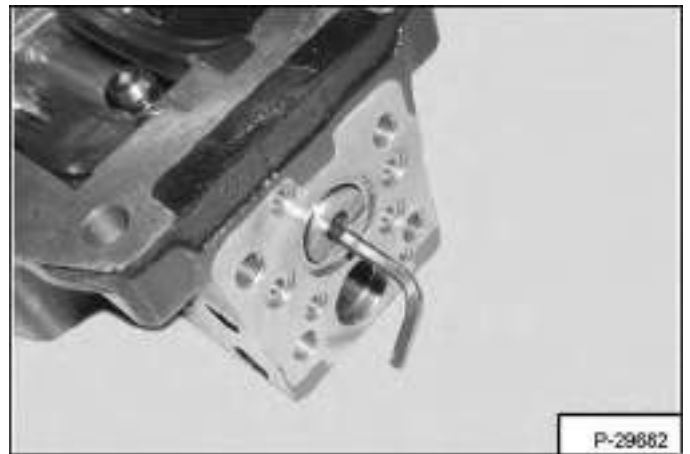

While holding the feedback lug, install the pointed set screw into the groove in the feedback lug [Figure 30-30-106].

Do not tighten at this time.

Figure 30-30-107

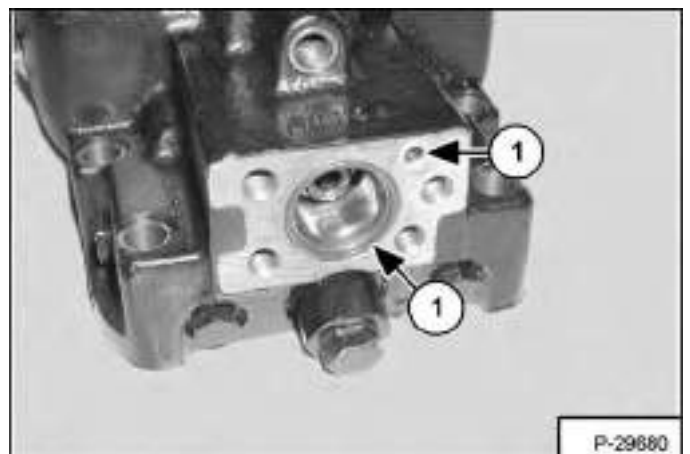

Install the two O-rings (Item 1) [Figure 30-30-107].

## HYDROSTATIC DRIVE MOTOR (CONT'D)

### Assembly (Cont'd)

Figure 30-30-108

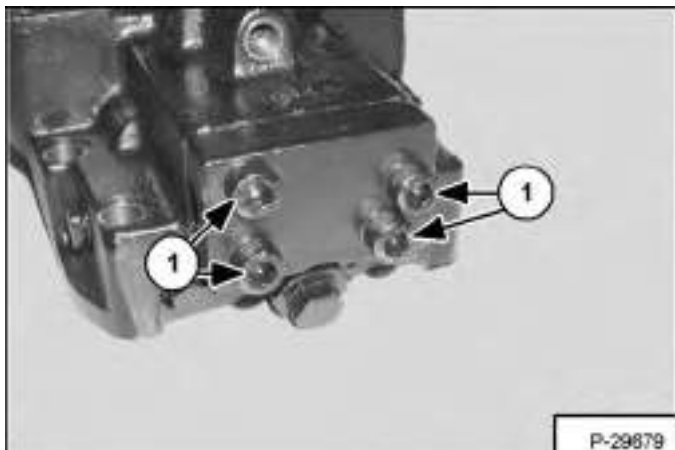

Install the end cap and tighten the four bolts (Item 1) [Figure 30-30-108] to 58 ft.-lb. (78 N•m) torque.

Figure 30-30-109

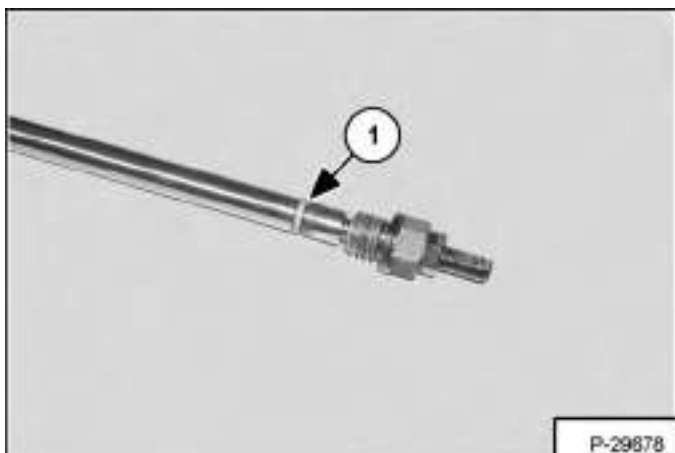

Install a new O-ring (Item 1) [Figure 30-30-109] onto the adjustment rod.

Figure 30-30-110

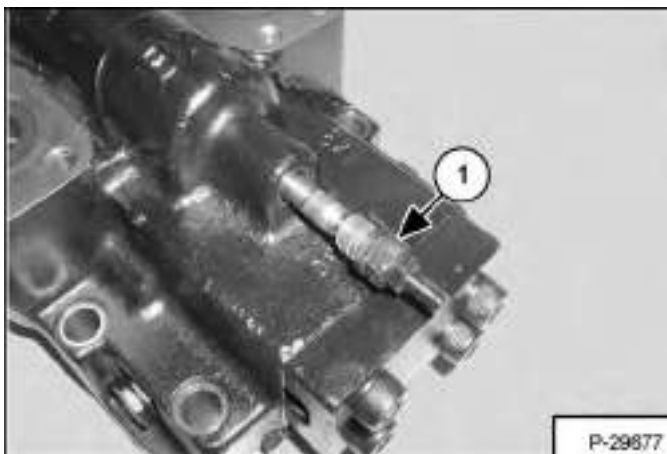

Install the adjustment rod (Item 1) [Figure 30-30-110] into the housing and through the feed back lug. Tighten the large nut to 15 ft.-lb. (20 N•m) torque.

Figure 30-30-111

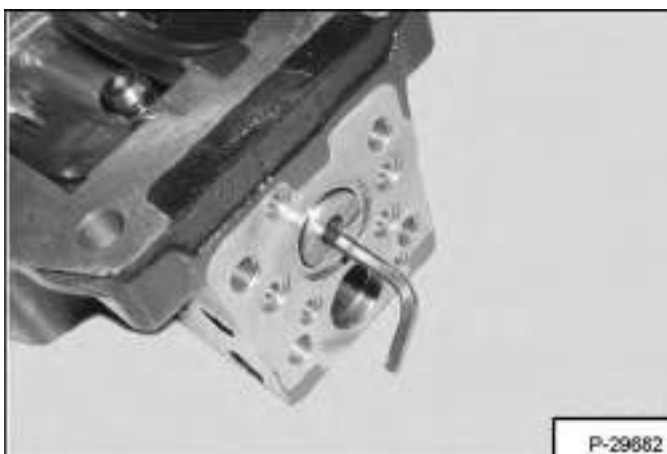

Tighten the pointed set screw at this time [Figure 30-30-111].

## HYDROSTATIC DRIVE MOTOR (CONT'D)

### Assembly (Cont'd)

Figure 30-30-112

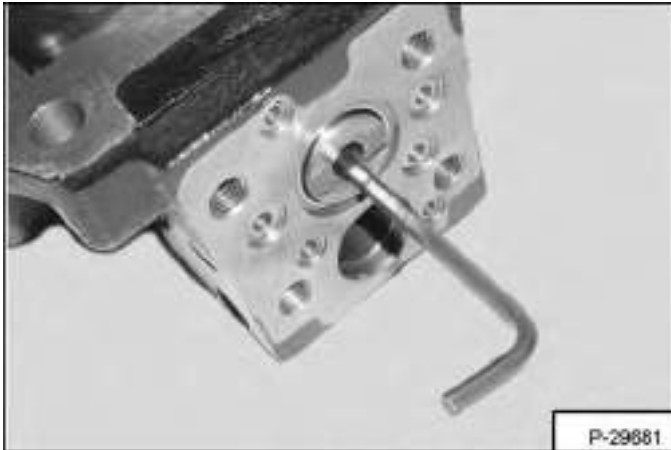

Install the second set screw and tighten [Figure 30-30-112].

Figure 30-30-113

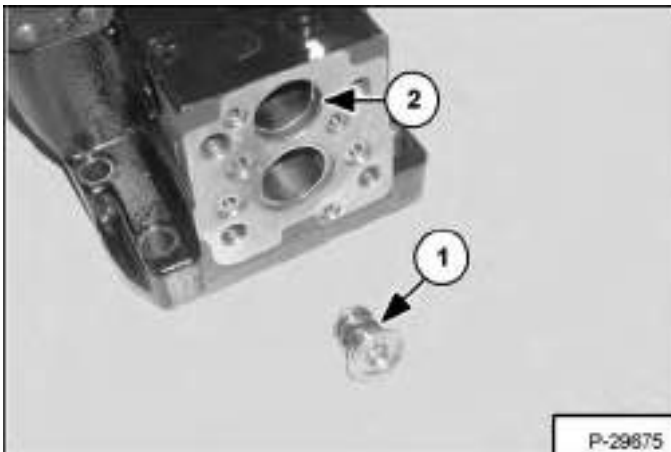

Install the two spring seats and spring (Item 1) into the servo piston hole (Item 2) [Figure 30-30-113].

**NOTE: Apply assembly lube to help hold into correct position.**

Figure 30-30-114

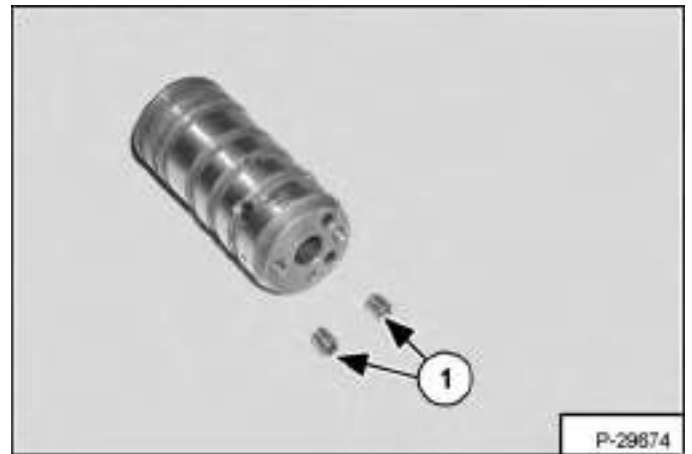

Install the two orifices (Item 1) [Figure 30-30-114] into the spool and tighten to 18 in.-lb. (2 N•m) torque.

Figure 30-30-115

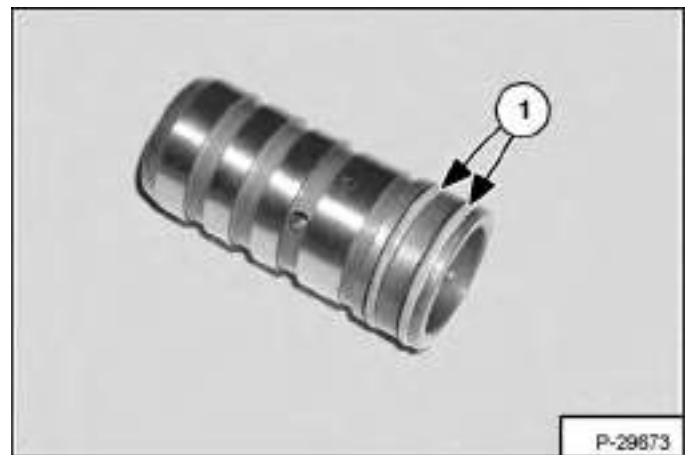

Install the two O-rings (Item 1) [Figure 30-30-115] onto the spool.

## HYDROSTATIC DRIVE MOTOR (CONT'D)

### Assembly (Cont'd)

Figure 30-30-116

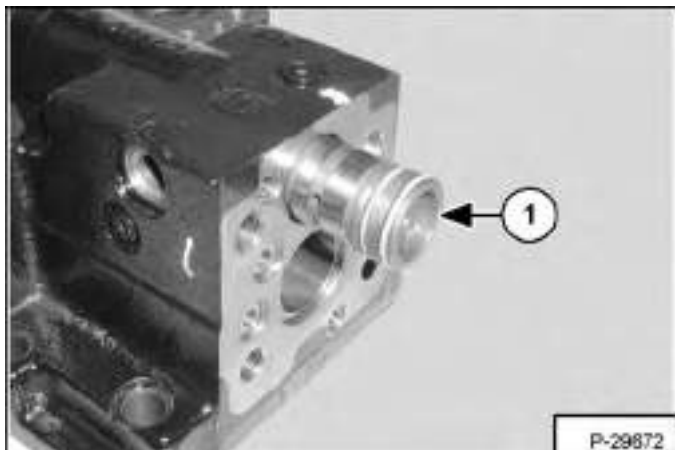

Install the servo control spool (Item 1) [Figure 30-30-116] into the housing.

Figure 30-30-117

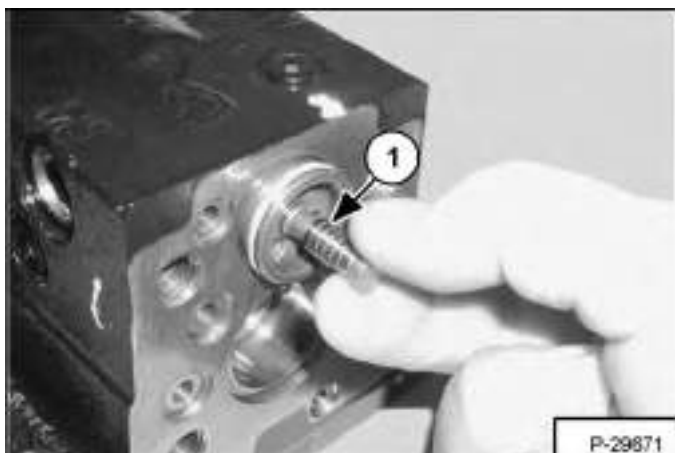

Install the inner spool (Item 1) [Figure 30-30-117].

Figure 30-30-118

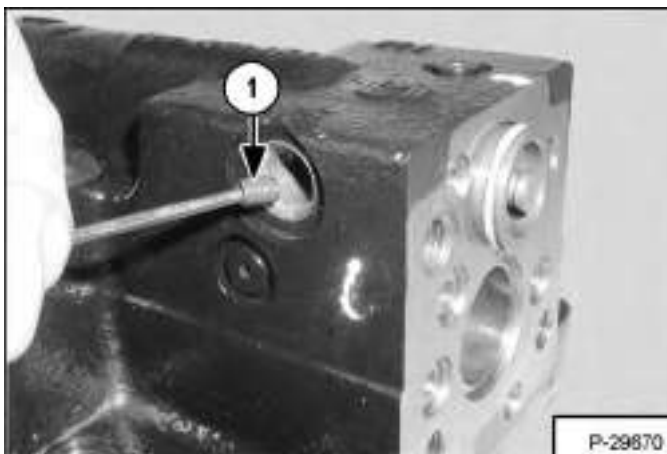

Install the orifice (Item 1) [Figure 30-30-118] into the housing and tighten to 4 ft.-lb. (5 N•m) torque.

Figure 30-30-119

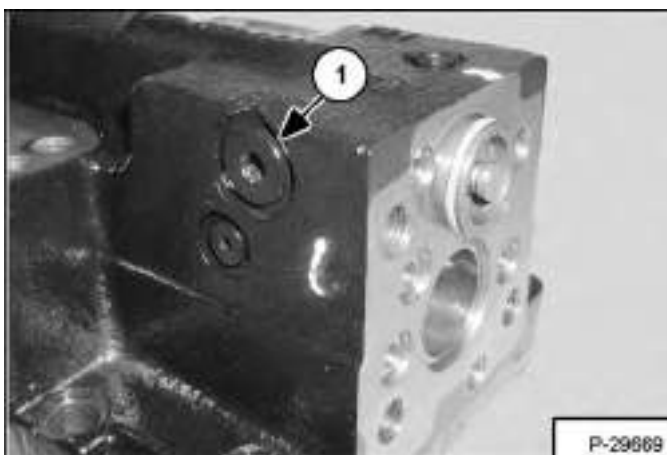

Install the plug (Item 1) [Figure 30-30-119] and tighten to 4 ft.-lb. (5 N•m) torque.

## HYDROSTATIC DRIVE MOTOR (CONT'D)

### Assembly (Cont'd)

Figure 30-30-120

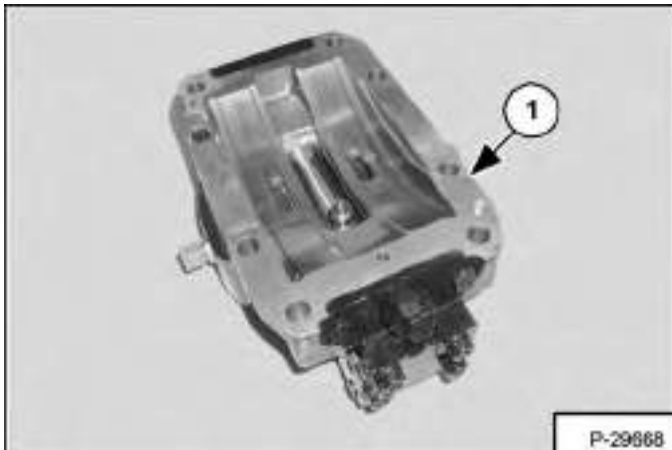

Install a new gasket (Item 1) [Figure 30-30-120] onto the end cap.

Figure 30-30-121

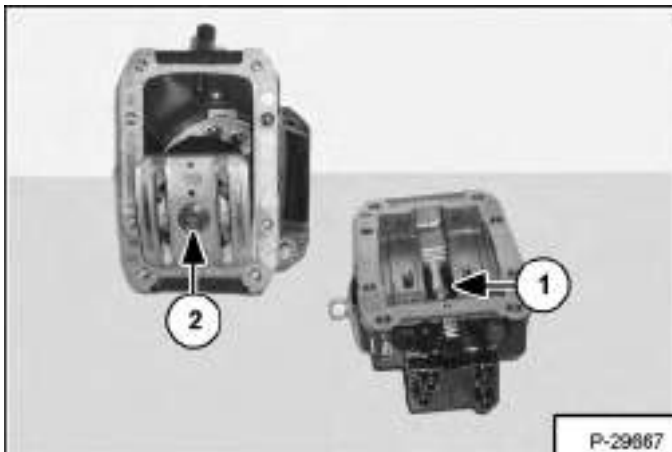

Align the feed back lug (Item 1) and the valve segment (Item 2) [Figure 30-30-121].

Figure 30-30-122

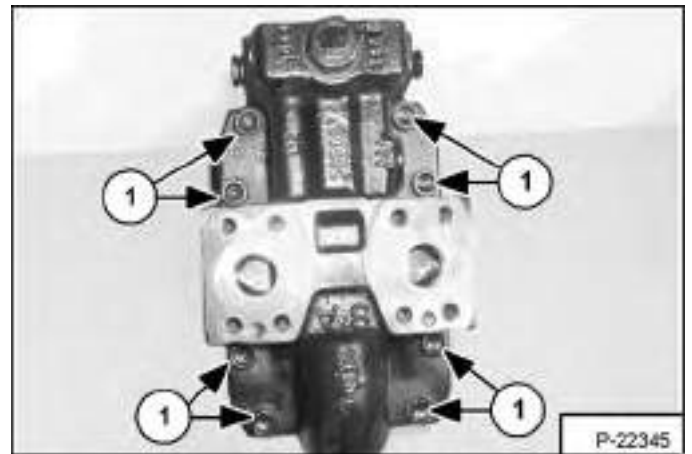

Install the end cap housing and tighten the eight bolts (Item 1) [Figure 30-30-122] to 85 ft.-lb. (115 N•m) torque.

Figure 30-30-123

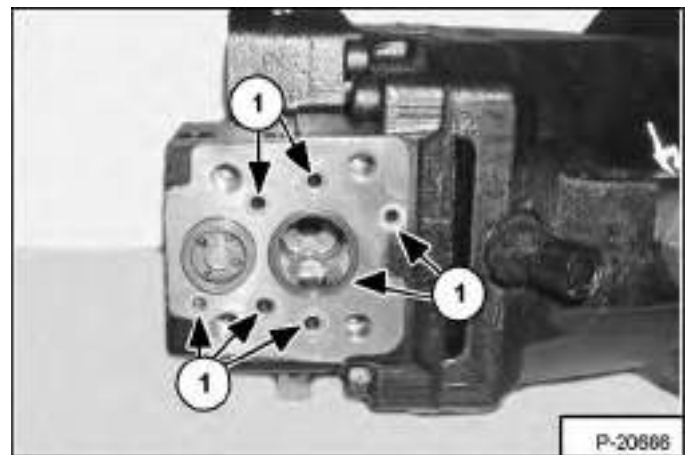

Install the seven O-rings (Item 1) [Figure 30-30-123].

## HYDROSTATIC DRIVE MOTOR (CONT'D)

### Assembly (Cont'd)

Figure 30-30-124

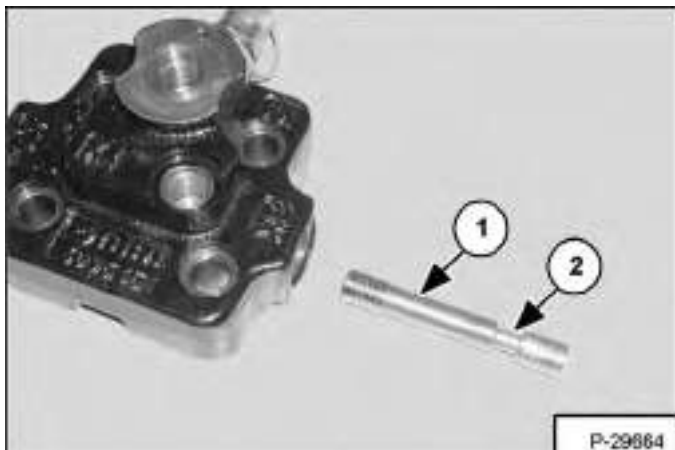

Install the spool (Item 1) [Figure 30-30-124] into the housing.

**NOTE:** The position of the groove (Item 2) [Figure 30-30-124].

Figure 30-30-125

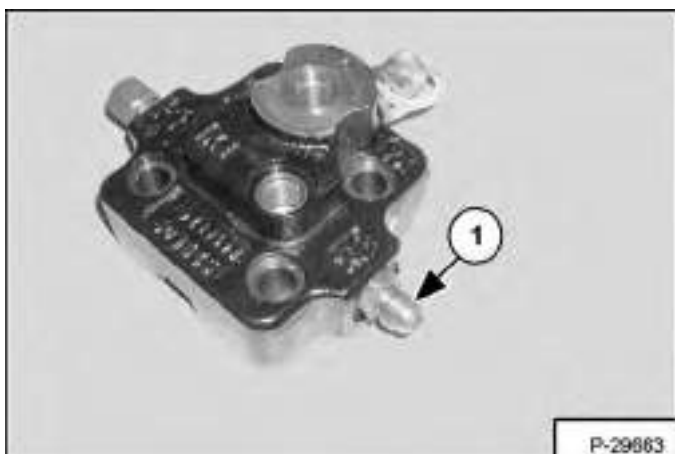

Install the fitting (Item 1) [Figure 30-30-125].

Figure 30-30-126



Install the pin into the housing as shown [Figure 30-30-126].

Figure 30-30-127

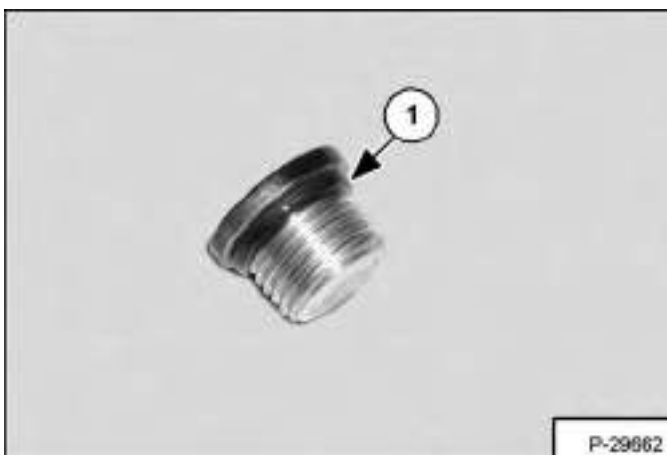

Install a new O-ring (Item 1) [Figure 30-30-127] on the plug.



## HYDROSTATIC DRIVE MOTOR (CONT'D)

### Assembly (Cont'd)

Figure 30-30-128

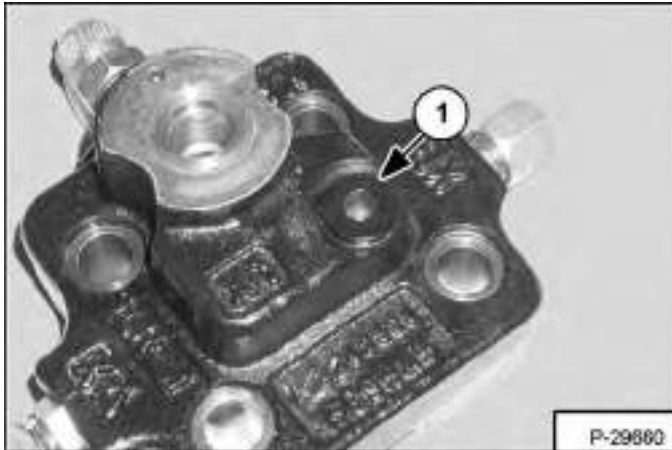

Install the plug (Item 1) [Figure 30-30-128] and tighten to 4 ft.-lb. (5 N•m) torque.

Figure 30-30-129

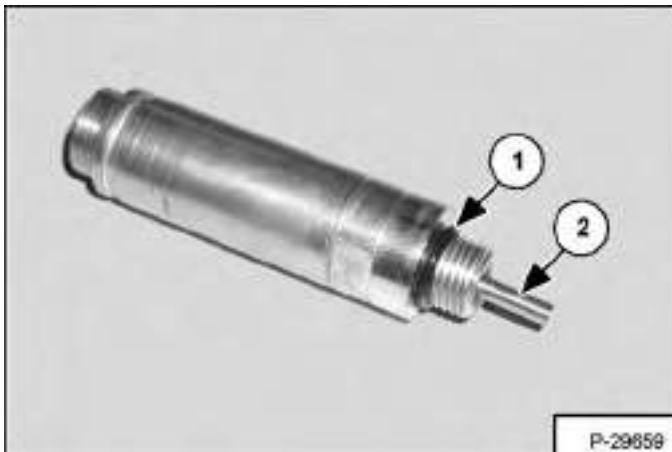

Install a new O-ring (Item 1) [Figure 30-30-129] onto the solenoid shaft.

Lightly lubricate the pin (Item 2) [Figure 30-30-129] and install into the solenoid shaft.

Figure 30-30-130

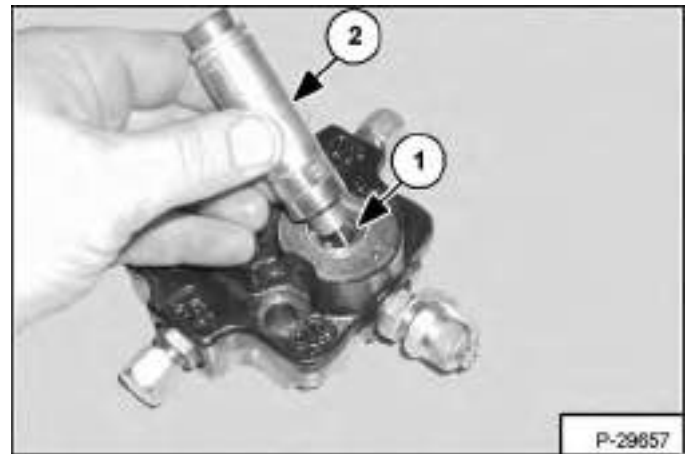

Install a new O-ring (Item 1) and solenoid shaft assembly (Item 2) [Figure 30-30-130] into the housing.

Figure 30-30-131

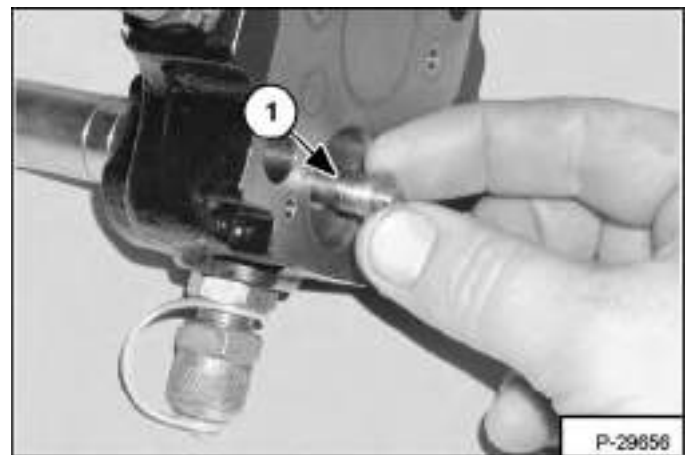

Install the spool (Item 1) [Figure 30-30-131] into the housing.

## HYDROSTATIC DRIVE MOTOR (CONT'D)

### Assembly (Cont'd)

Figure 30-30-132



Install a new O-ring (Item 1) [Figure 30-30-132] on the solenoid.

Figure 30-30-133



Install the solenoid (Item 1) [Figure 30-30-133].

Figure 30-30-134

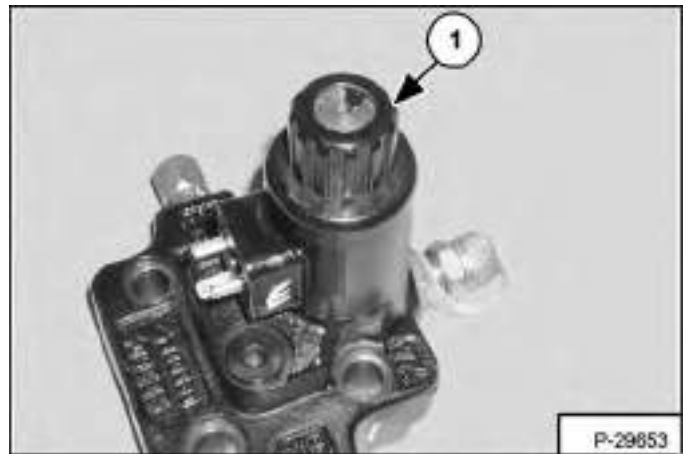

Install the solenoid nut (Item 1) [Figure 30-30-134] and hand tighten.

Figure 30-30-135

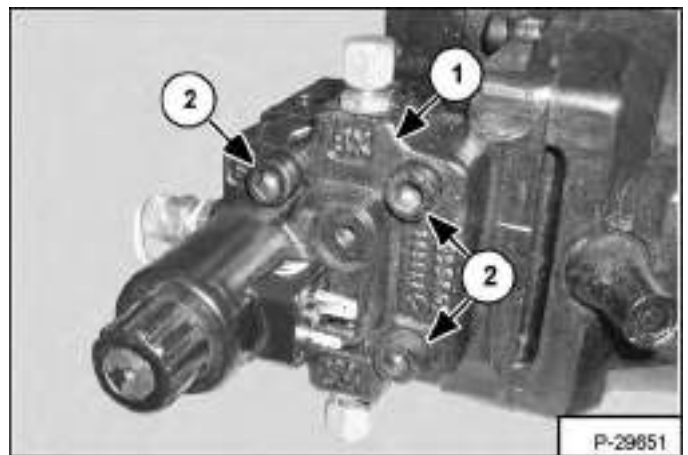

Install the solenoid housing assembly (Item 1). Tighten the bolts (Item 2) [Figure 30-30-135] to 58 ft.-lb. (78 N•m) torque.

## HYDROSTATIC PUMP

### Removal And Installation

Remove the gear pump. (See "Removal And Installation" on page 20-130-1.)

# IMPORTANT

When repairing hydrostatic and hydraulic systems, clean the work area before disassembly and keep all parts clean. Always use caps and plugs on hoses, tubelines and ports to keep dirt out. Dirt can quickly damage the system.

I-2003-0888

Figure 30-40-1

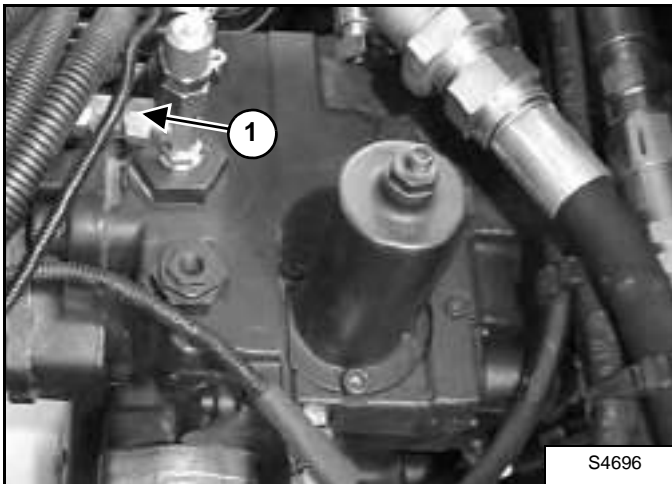

Remove the hose (Item 1) [Figure 30-40-1] from the top of the hydrostatic pump.

**NOTE:** Mark all hoses for correct installation.

Figure 30-40-2

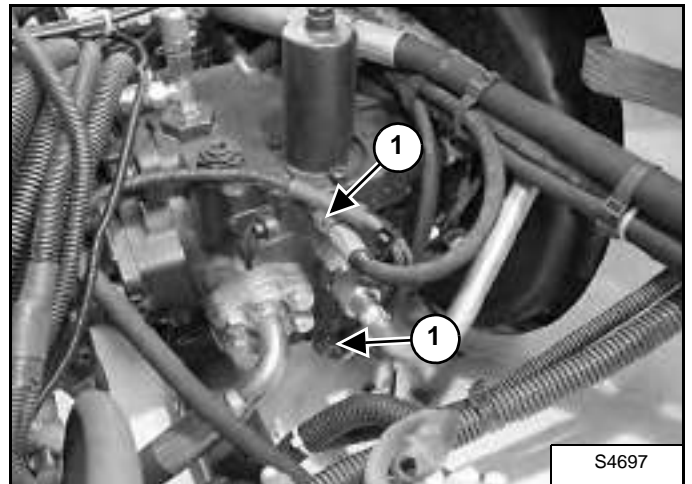

Remove the two hoses (Item 1) [Figure 30-40-2].

Figure 30-40-3

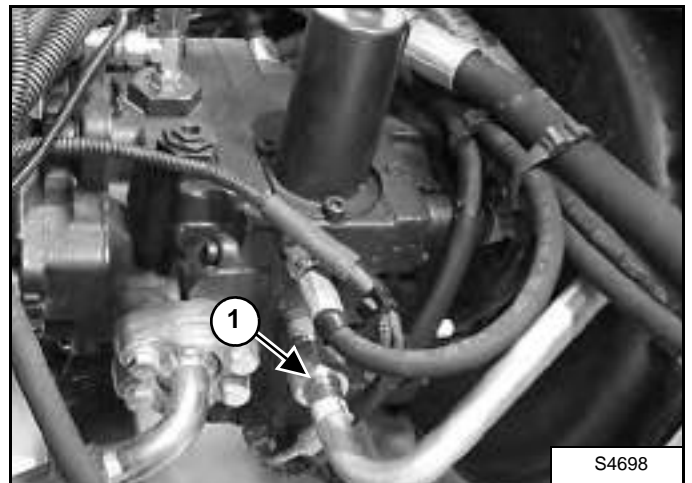

Remove the tubeline (Item 1) [Figure 30-40-3].

## HYDROSTATIC PUMP (CONT'D)

### Removal And Installation (Cont'd)

Figure 30-40-4

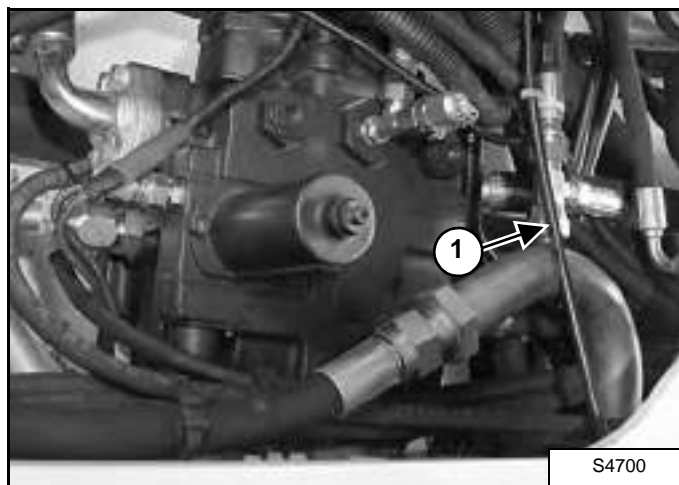

Remove the hose (Item 1) [Figure 30-40-4] from the tubeline.

Figure 30-40-5



Remove the four bolt flange hose (Item 1) [Figure 30-40-5] from the front of the pump.

Figure 30-40-6

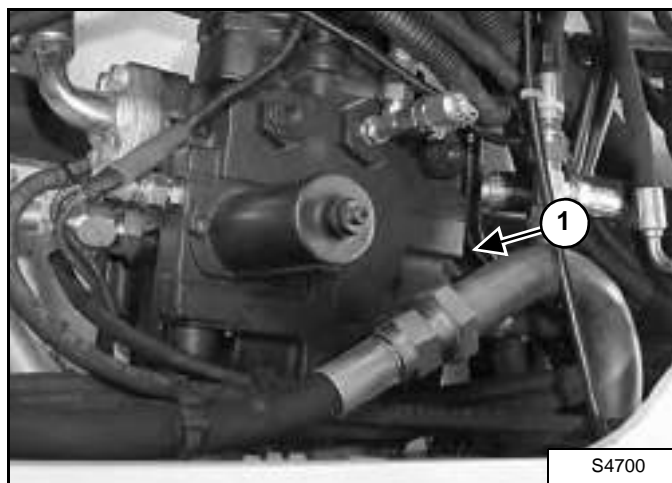

Remove the hoses on the right side of the hydrostatic pump (Item 1) [Figure 30-40-6].

Figure 30-40-7

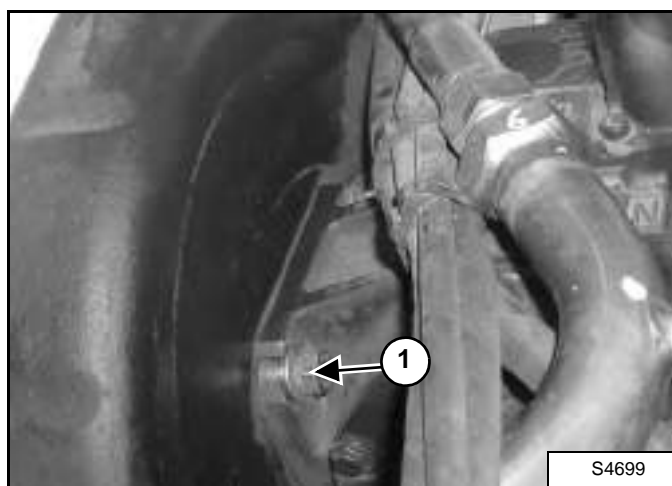

Install a chain hoist and lifting strap to lift and support the pump.

Remove the four mounting bolts (Item 1) [Figure 30-40-7].

Lift and remove the hydrostatic pump.

**NOTE:** It may be necessary to remove fittings from the pump for complete removal.

## HYDROSTATIC PUMP (CONT'D)

### Parts Identification

1. Multi-Function Valve Assembly
2. O-Ring
3. Plug
4. Plug
5. Nut
6. Charge Relief
7. O-Ring
8. Spring
9. Poppet
10. Plug
11. Control Filter Screen
12. Bolt
13. Lip Seal
14. Cover
15. O-Ring
16. Retainer Plate

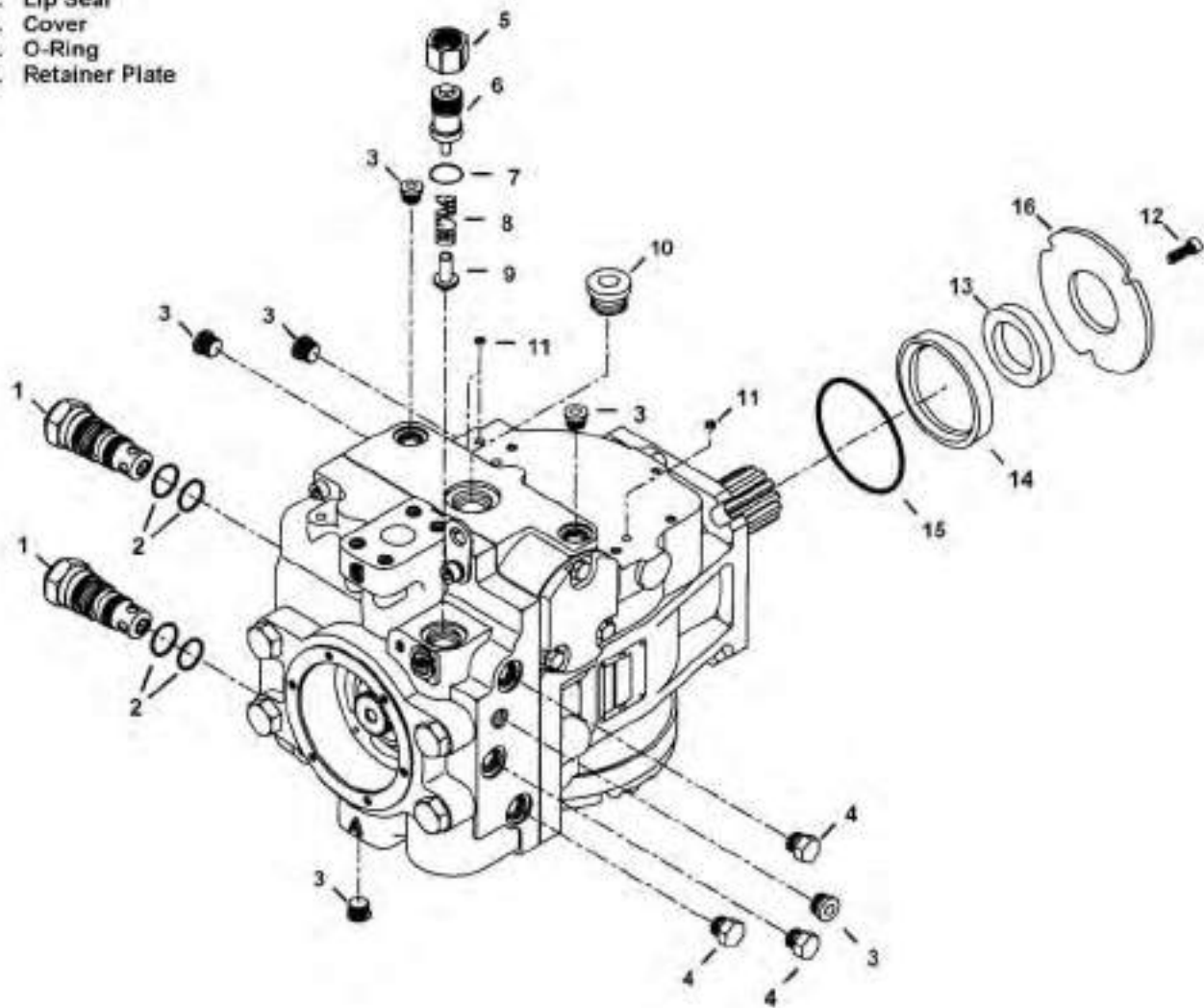

B-15899

## HYDROSTATIC PUMP (CONT'D)

### Parts Identification (Cont'd)

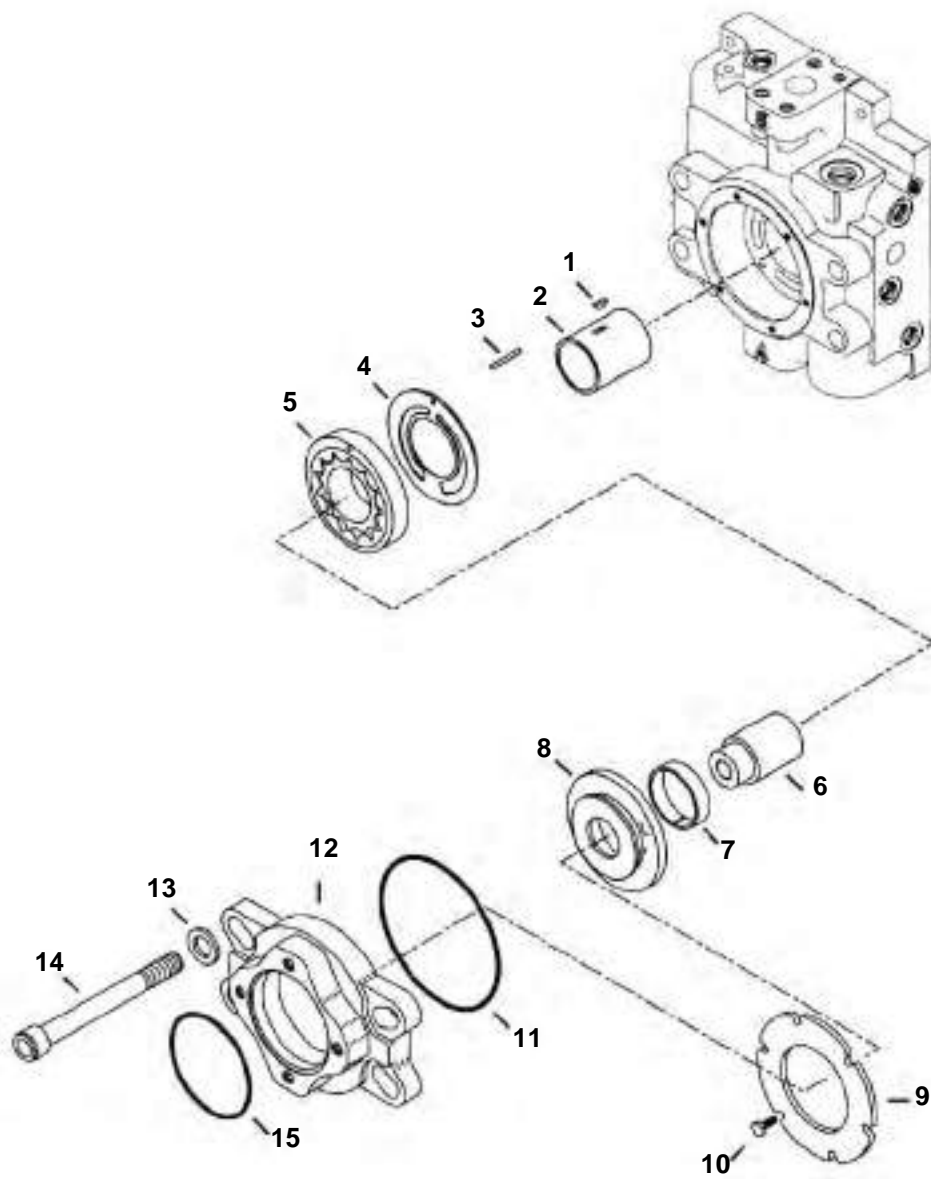

1. Key
2. Charge Pump Shaft
3. Pin
4. Wear Plate
5. Gears
6. Coupling
7. Seal
8. Charge Pump Cover
9. Retaining Plate
10. Bolt
11. O-Ring
12. Flange Adapter
13. Washer
14. Bolt
15. O-Ring

B-23195

## HYDROSTATIC PUMP (CONT'D)

### Parts Identification (Cont'd)

1. Valve Plate
2. Retaining Ring
3. Spring Retainer
4. Spring
5. Spring Seat
6. Cylinder
7. Bolt
8. Slipper Guide Bearing
9. Spacer
10. Slipper Guide
11. Piston
12. Bolt
13. Bolt
14. Block
15. Spring
16. Servo Arm
17. Pin
18. Washer
19. Swash Plate Guide
20. Pin
21. Housing
22. Swash Plate
23. Bearing Assembly
24. Pin
25. Housing

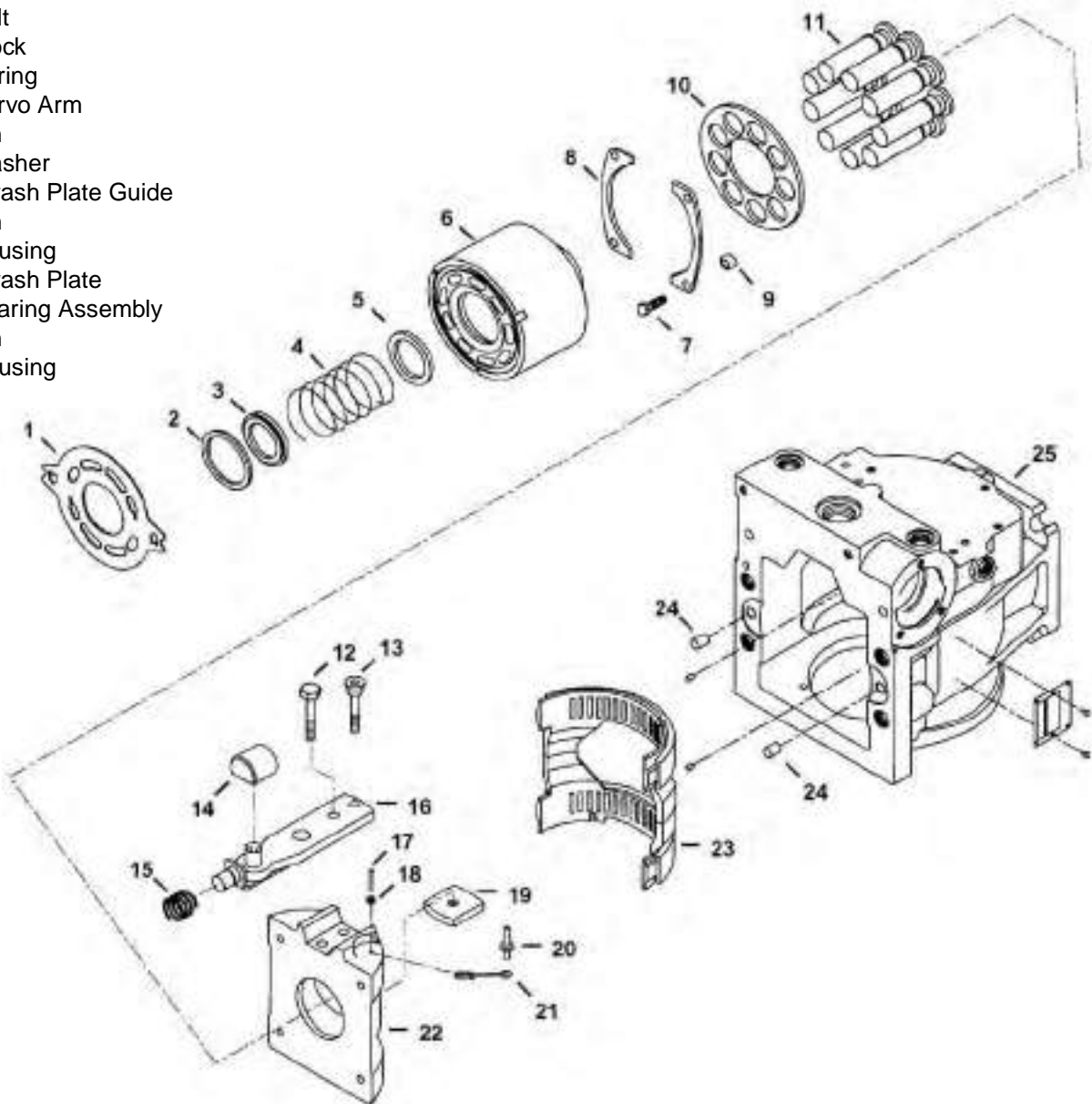

B-19856

## HYDROSTATIC PUMP (CONT'D)

### Parts Identification (Cont'd)

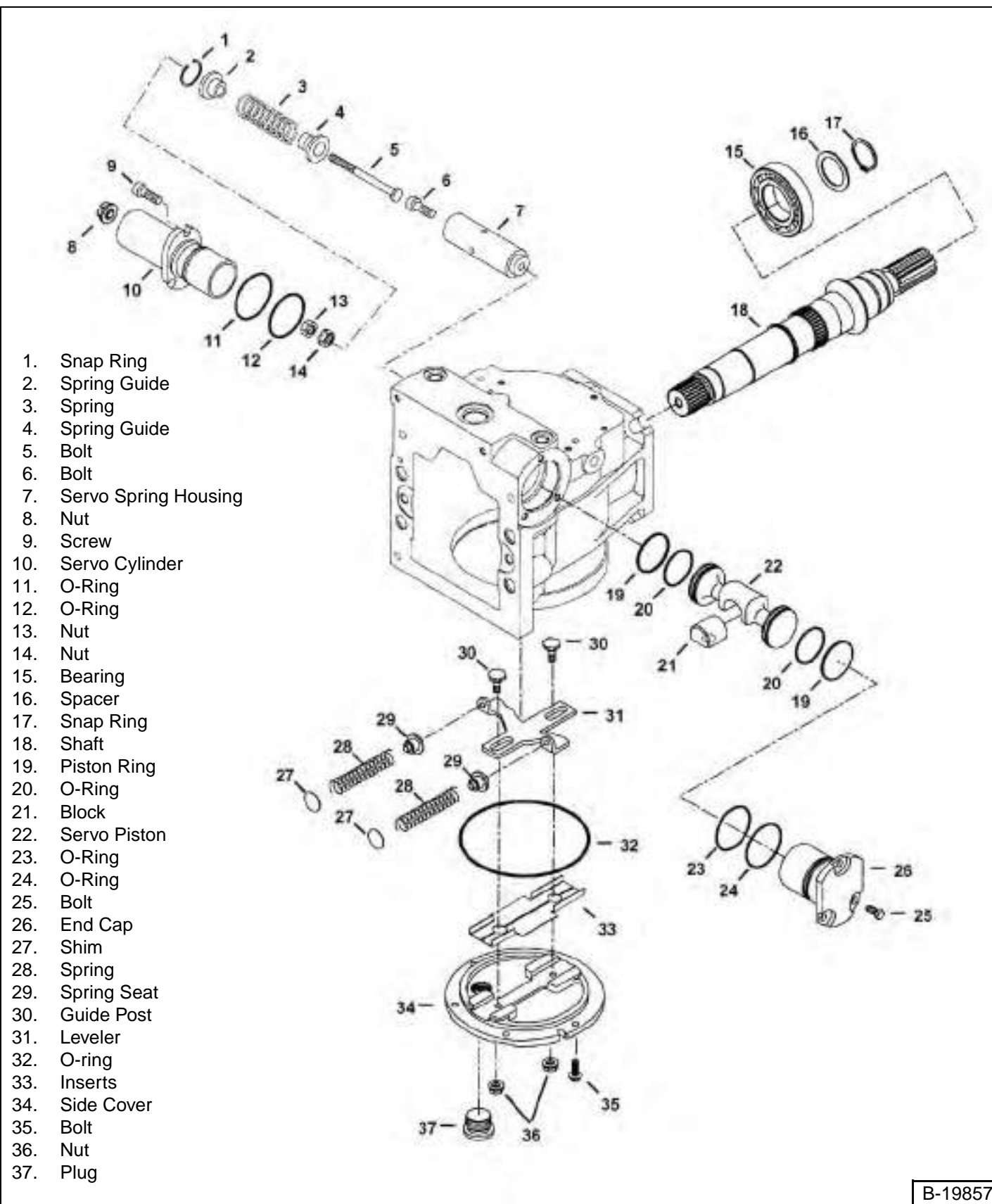

B-19857



## HYDROSTATIC PUMP (CONT'D)

### Disassembly

# IMPORTANT

When repairing hydrostatic and hydraulic systems, clean the work area before disassembly and keep all parts clean. Always use caps and plugs on hoses, tubelines and ports to keep dirt out. Dirt can quickly damage the system.

I-2003-0888

Figure 30-40-8

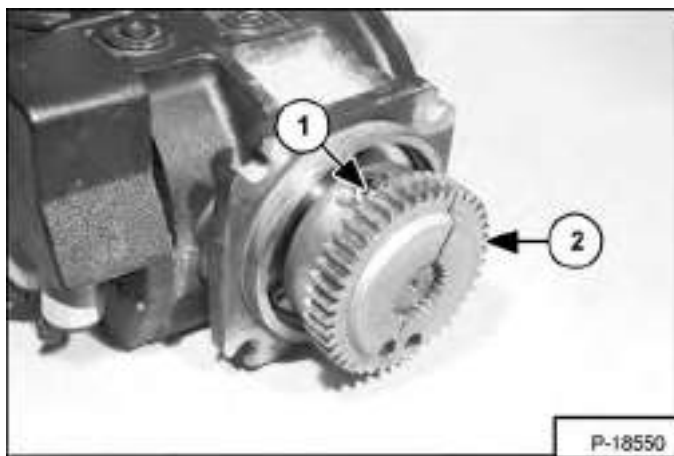

Remove the retainer bolt (Item 1). Remove the coupler gear (Item 2) [Figure 30-40-8] from the shaft.

Figure 30-40-9

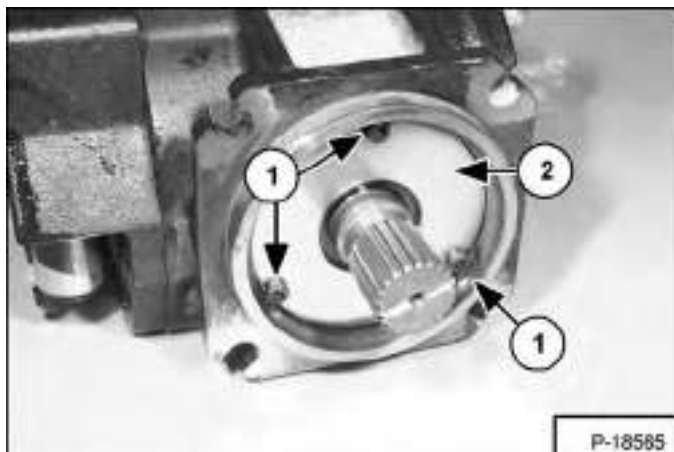

Remove the three screws (Item 1) [Figure 30-40-9].

Remove the retainer plate (Item 2) [Figure 30-40-9] from the pump housing.

Figure 30-40-10

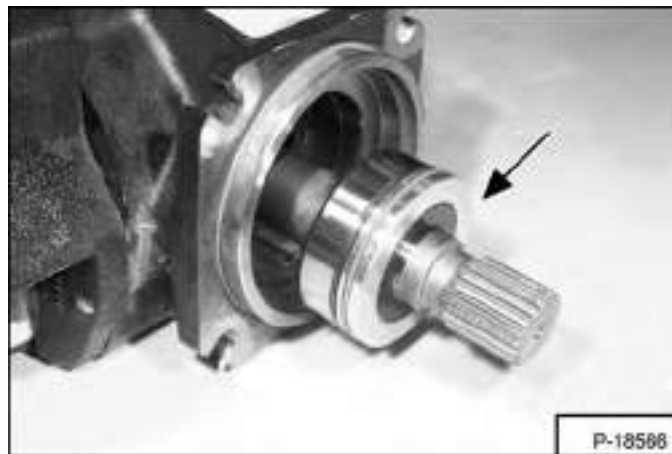

Remove the shaft and bearing assembly from the housing [Figure 30-40-10].

**NOTE:** If the shaft or bearing assembly become stuck in the housing, lightly tap on the shaft.

Figure 30-40-11



Remove the shaft seal (Item 1) [Figure 30-40-11] from the shaft.

## HYDROSTATIC PUMP (CONT'D)

### Disassembly (Cont'd)

Figure 30-40-12



Remove the snap ring (Item 1) and spacer washer (Item 2) [Figure 30-40-12] from the shaft.

Figure 30-40-13



Remove the bearing (Item 1) [Figure 30-40-13] from the shaft.

Place the pump on the work surface with the charge pump up.

Mark the pump housings for correct assembly.

Before removing the relief valve mark the plug, lock nut and housing for approximate assembly adjustment.

Figure 30-40-14

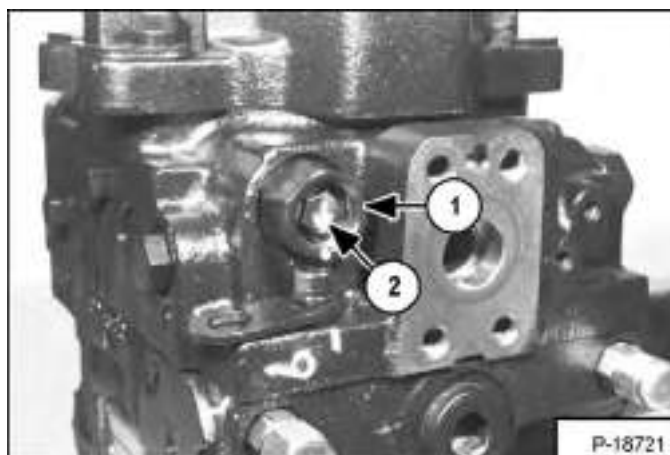

Remove the relief valve lock nut (Item 1) and the plug (Item 2) [Figure 30-40-14].

Figure 30-40-15

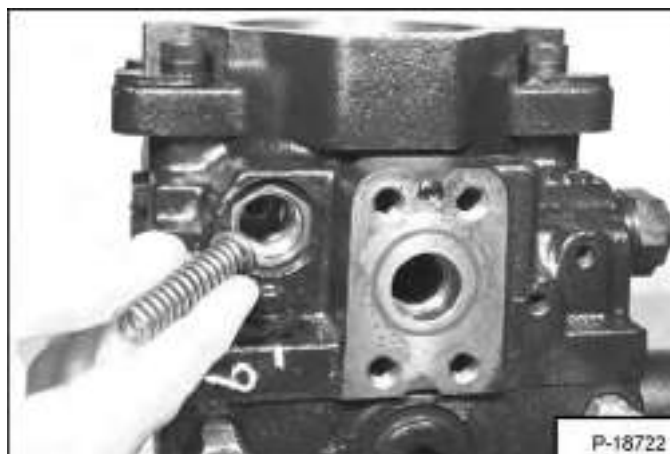

Remove the spring and relief poppet from the charge pump housing [Figure 30-40-15].

## HYDROSTATIC PUMP (CONT'D)

### Disassembly (Cont'd)

Figure 30-40-16

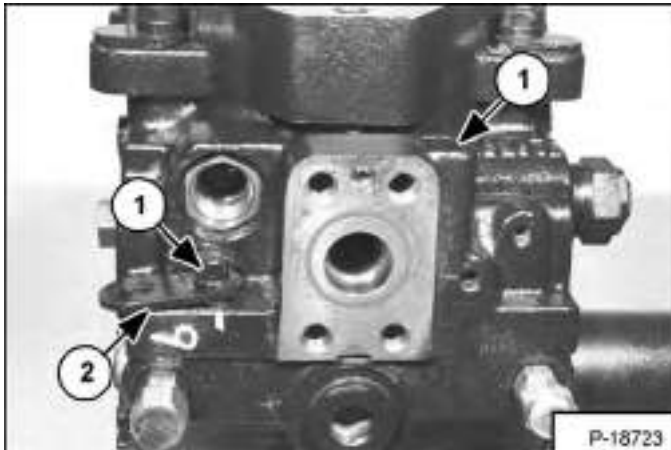

Remove the two mounting bolts (Item 1) [Figure 30-40-16].

**NOTE:** Remove the lifting bracket (Item 2) [Figure 30-40-16] from the pump.

Figure 30-40-17

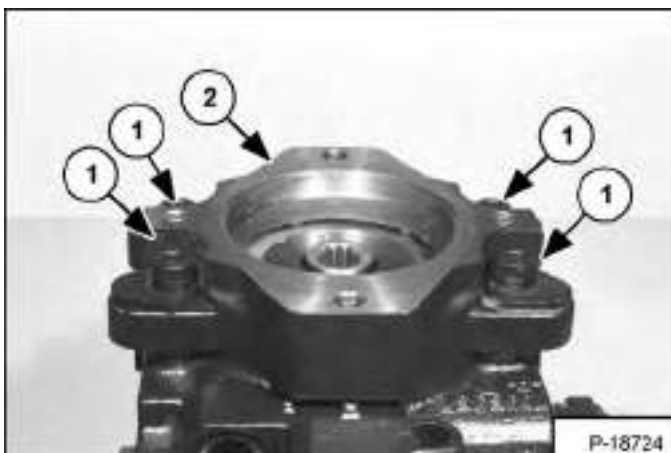

Remove the four mounting bolts (Item 1) [Figure 30-40-17] from the flange adapter.

Remove the flange adapter (Item 2) [Figure 30-40-17].

Figure 30-40-18

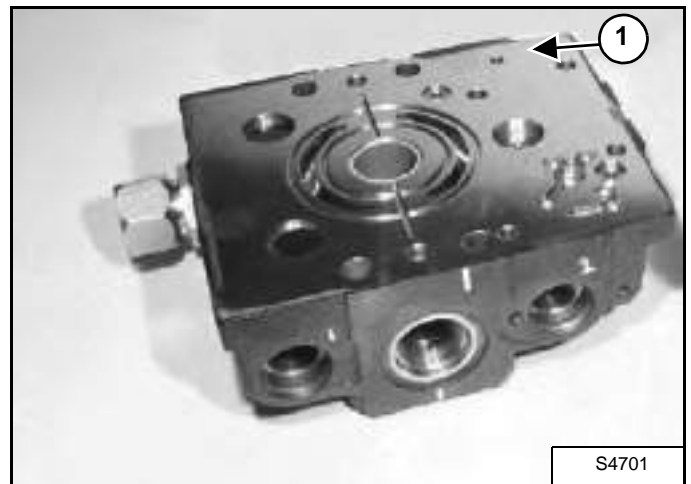

Lift and remove the charge pump (Item 1) [Figure 30-40-18] from the pump housing.

Figure 30-40-19

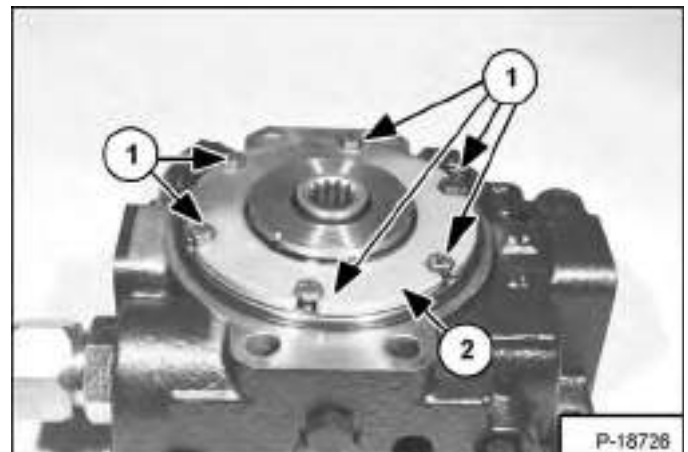

Remove the six bolts (Item 1) and remove the retaining plate (Item 2) [Figure 30-40-19] from the charge pump.

## HYDROSTATIC PUMP (CONT'D)

### Disassembly (Cont'd)

Figure 30-40-20

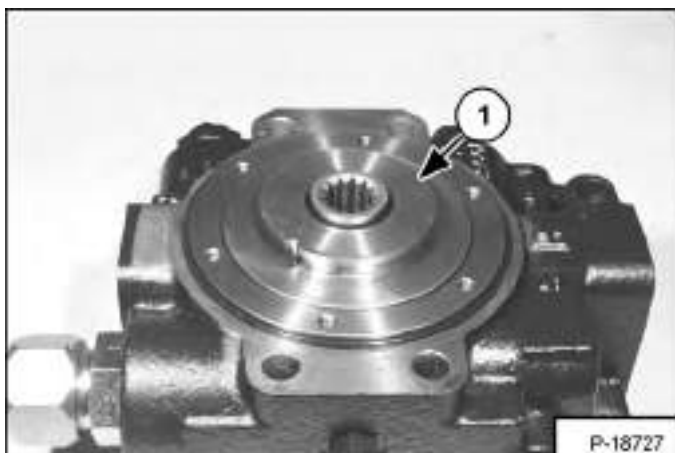

Remove the charge pump cover (Item 1) [Figure 30-40-20].

Figure 30-40-21

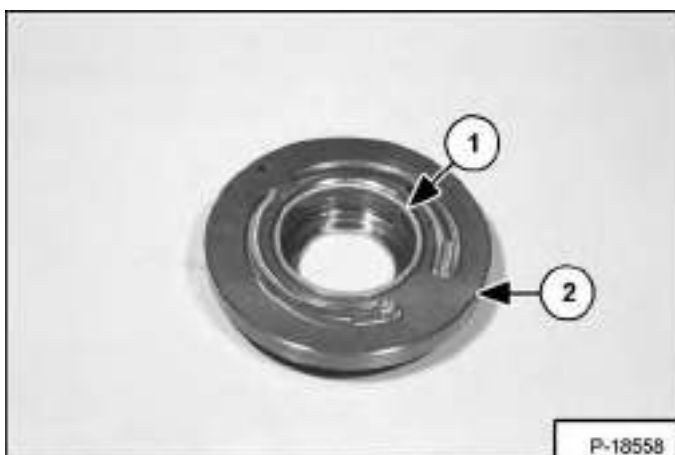

Only if wear marks are present, remove the bushing (Item 1) from the charge pump cover (Item 2) [Figure 30-40-21].

Figure 30-40-22

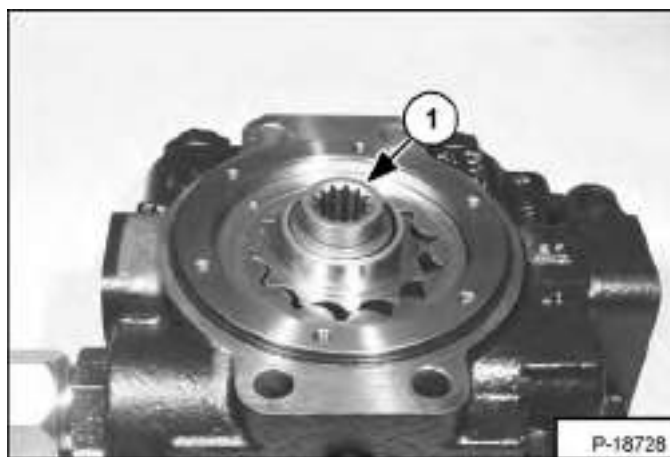

Remove the coupler (Item 1) [Figure 30-40-22].

Figure 30-40-23

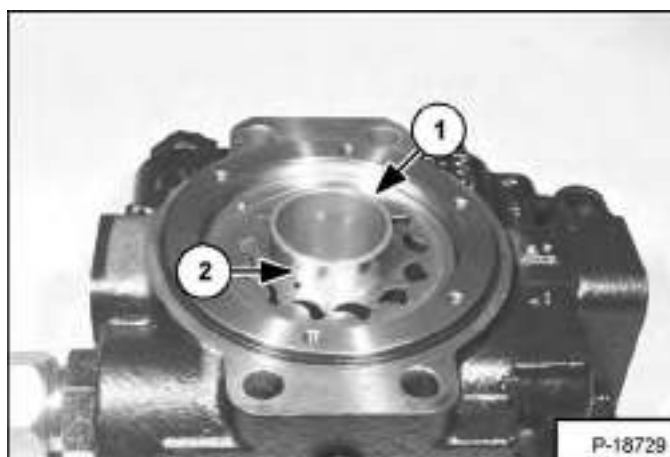

Remove the charge pump shaft (Item 1) and key (Item 2) [Figure 30-40-23] from the pump.

## HYDROSTATIC PUMP (CONT'D)

### Disassembly (Cont'd)

Figure 30-40-24

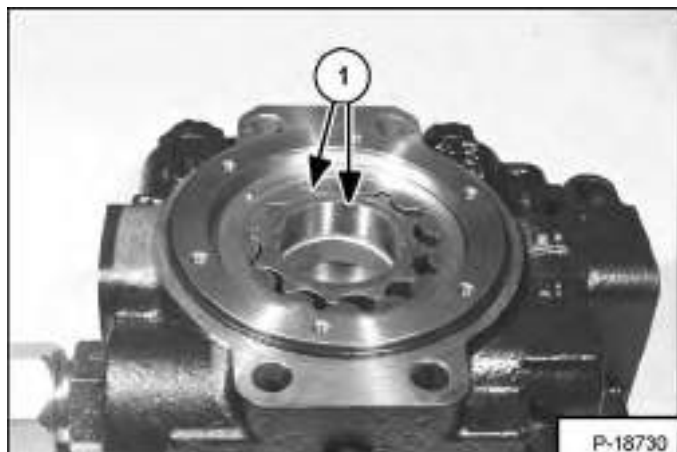

Remove the charge pump gears (Item 1) [Figure 30-40-24].

Figure 30-40-25

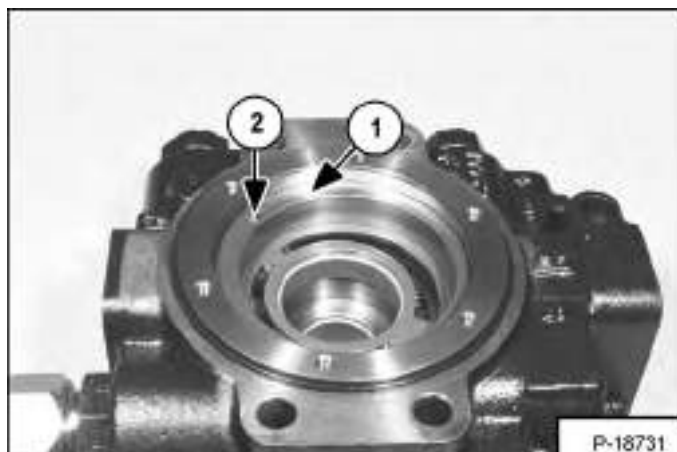

Remove the eccentric ring (Item 1) and alignment pin (Item 2) [Figure 30-40-25] from the pump.

Note the position of the alignment pin.

Figure 30-40-26

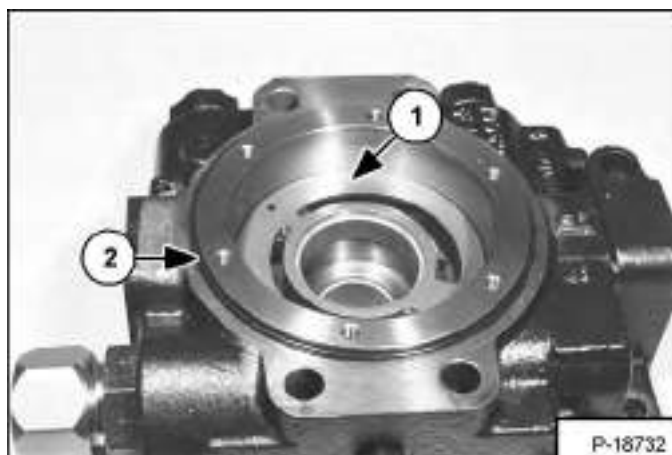

Remove the charge pump wear plate (Item 1) [Figure 30-40-26].

Remove the O-ring (Item 2) [Figure 30-40-26].

Figure 30-40-27

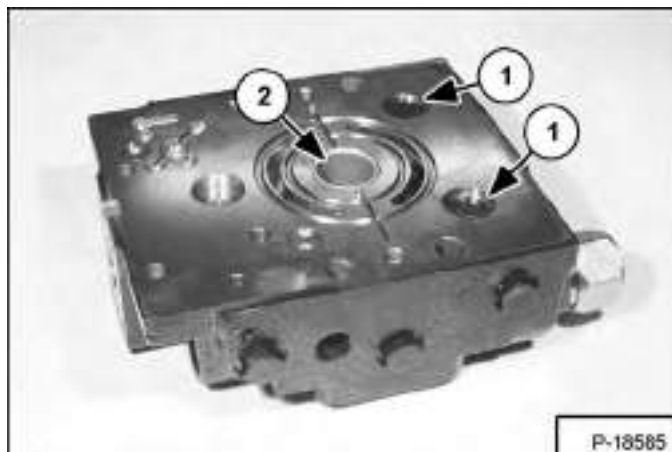

Remove the swash plate leveler spring shims (Item 1) [Figure 30-40-27] from the spring pockets.

Inspect the journal bearing (Item 2) [Figure 30-40-27]. Replace as needed.

## HYDROSTATIC PUMP (CONT'D)

### Disassembly (Cont'd)

Figure 30-40-28

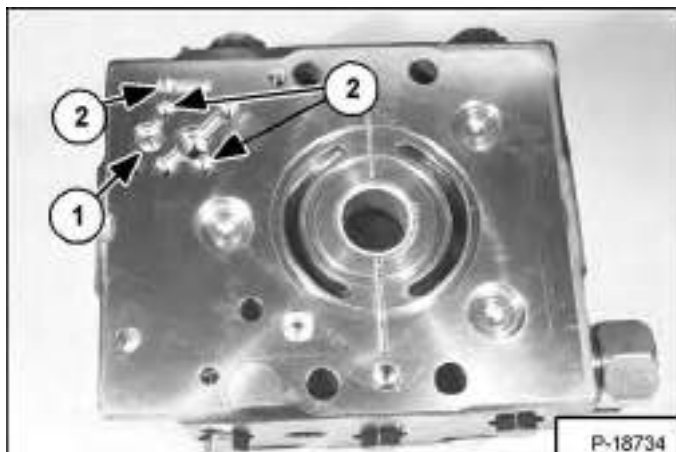

For proper operation, if the plugs (Items 1 & 2) [Figure 30-40-28] are removed from the housing they must be returned to their original position.

**Installation:** Tighten the servo relief valve plug (Item 1) to 9 ft.-lb. (12 N•m) torque. Tighten the rotation pipe plugs (Item 2) [Figure 30-40-28] to 4 ft.-lb. (5,4 N•m) torque.

Figure 30-40-29

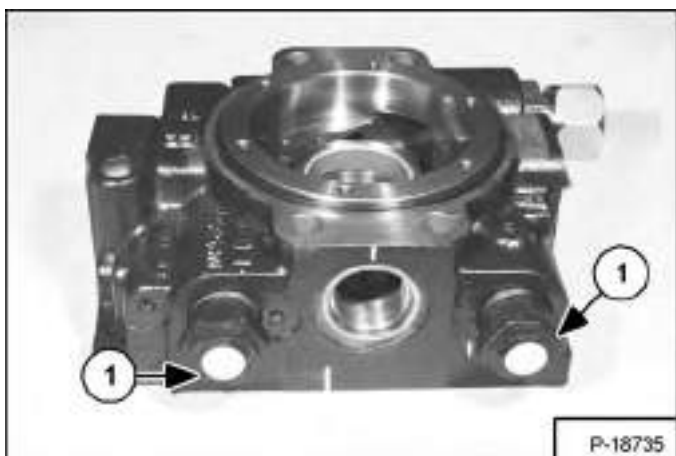

Remove the multi-function valve assemblies (Item 1) [Figure 30-40-29] from the housing.

Figure 30-40-30

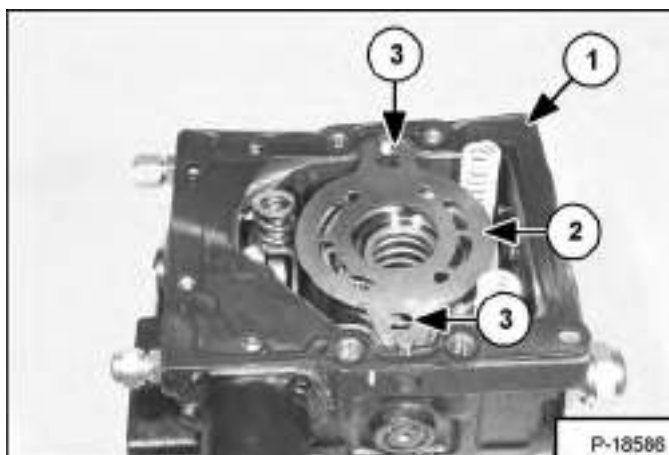

Remove the gasket (Item 1) and the valve plate (Item 2) from the housing. Note the direction of the arrows (Item 3) [Figure 30-40-30] on the valve plate for proper assembly.

Figure 30-40-31

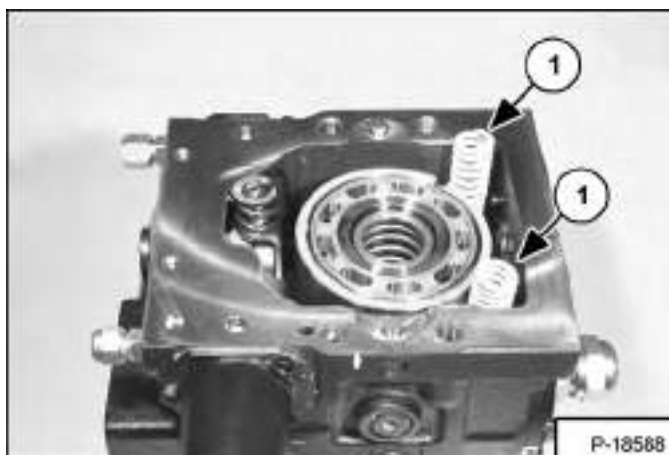

Remove the two leveler springs (Item 1) [Figure 30-40-31].

## HYDROSTATIC PUMP (CONT'D)

### Disassembly (Cont'd)

Figure 30-40-32

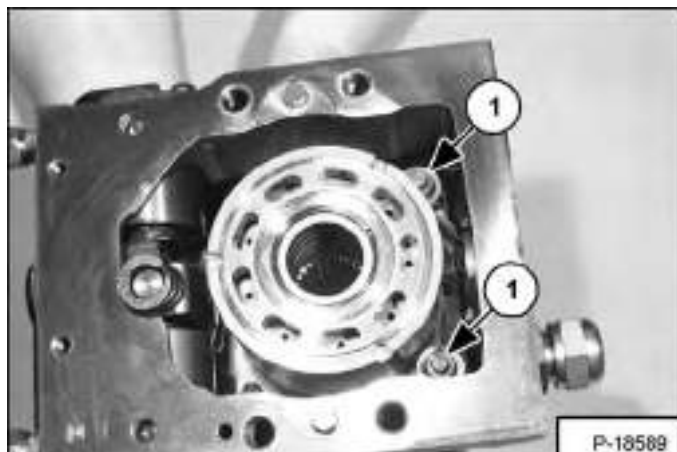

Remove both spring seats (Item 1) [Figure 30-40-32] from the swash plate leveler.

Figure 30-40-33

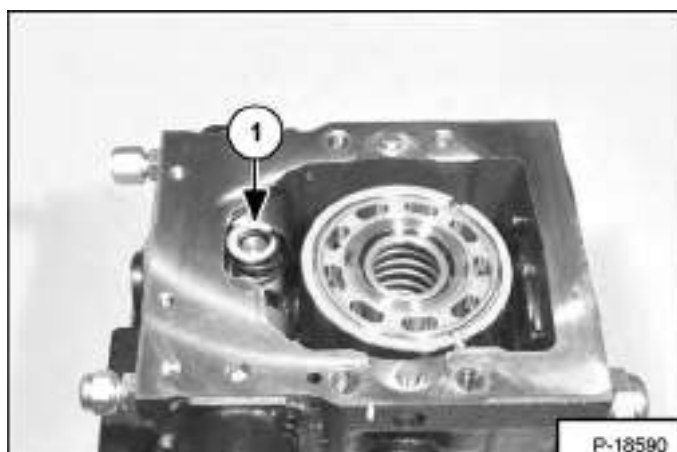

Remove the swash plate hold down spring (Item 1) [Figure 30-40-33].

Mark the position of the side cover.

Figure 30-40-34

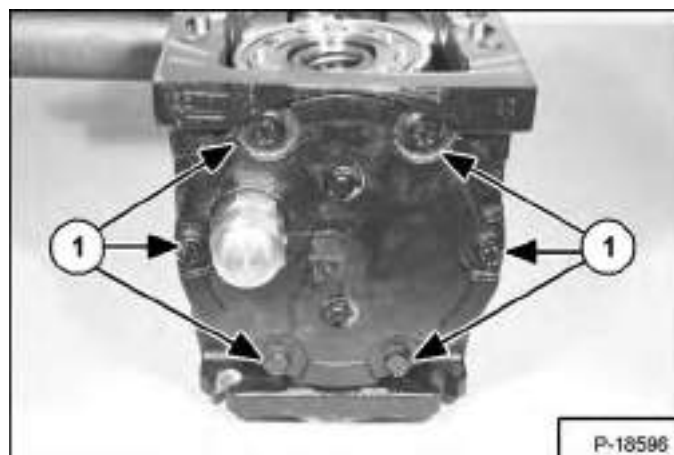

Remove the six bolts (Item 1) [Figure 30-40-34] from the side cover.

Figure 30-40-35

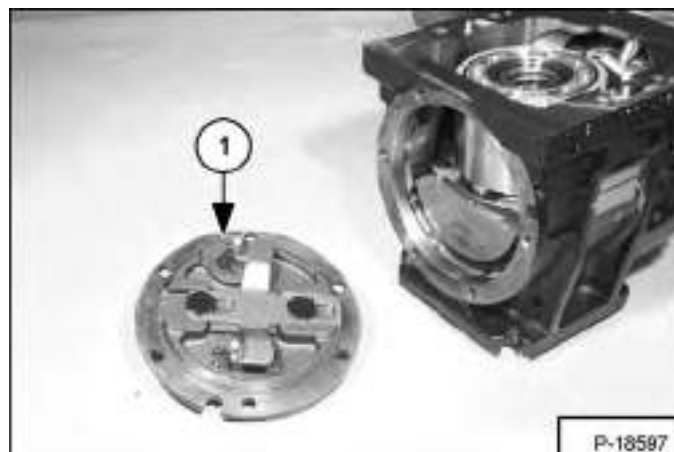

Remove the side cover / swash plate leveler assembly from the housing [Figure 30-40-35].

## HYDROSTATIC PUMP (CONT'D)

### Disassembly (Cont'd)

Figure 30-40-36

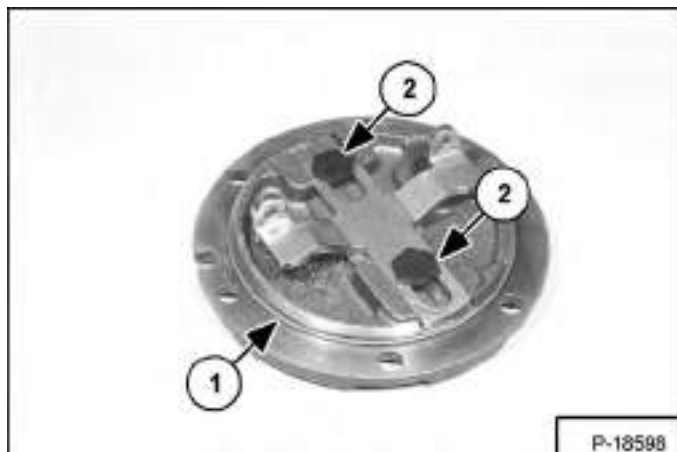

Remove and discard the O-ring (Item 1). Loosen and remove both guide posts (Item 2) [Figure 30-40-36].

Figure 30-40-37

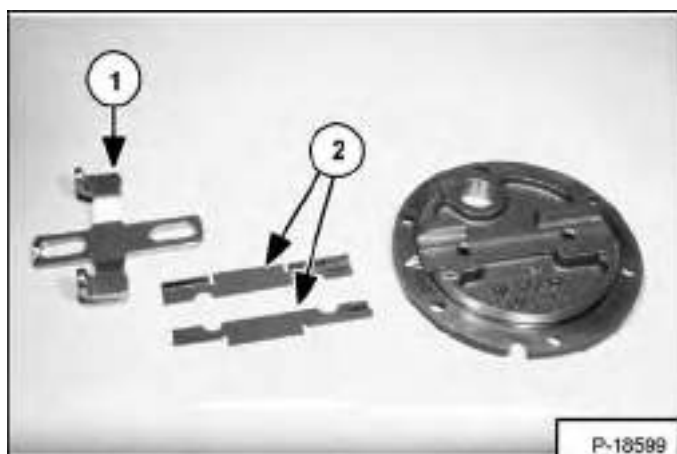

Remove the leveler (Item 1) and slide inserts (Item 2) [Figure 30-40-37] from the side cover.

Inspect the slide inserts for wear or damage.

Replace if needed.

Figure 30-40-38

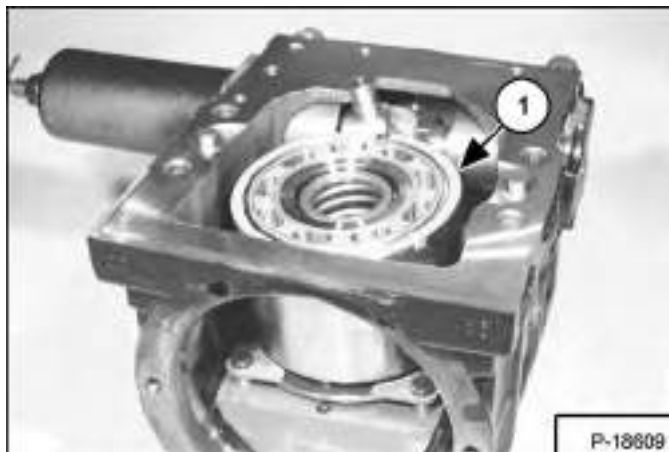

Remove the cylinder block (Item 1) [Figure 30-40-38] through the housing end opening. The swash plate and piston assembly will remain in the housing.

Figure 30-40-39

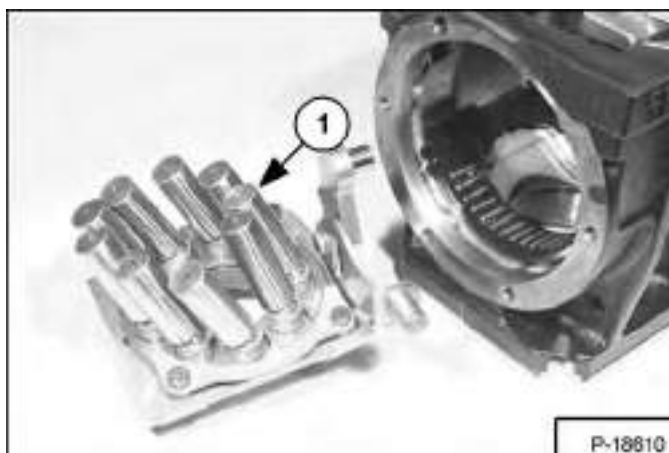

Remove the swash plate / piston assembly (Item 1) [Figure 30-40-39] from the pump housing.



## HYDROSTATIC PUMP (CONT'D)

### Disassembly (Cont'd)

Figure 30-40-40

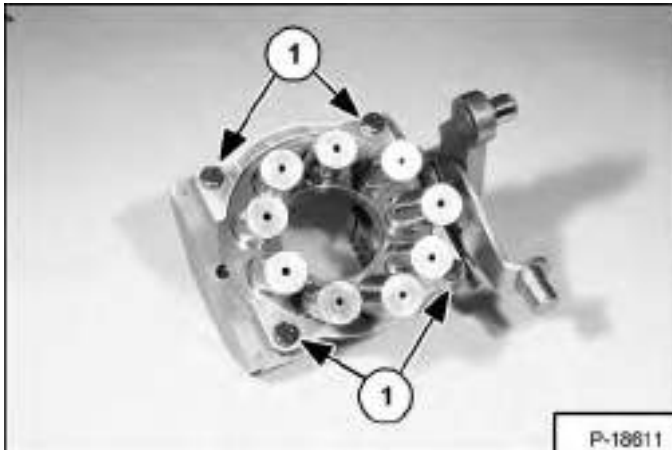

Remove the four slipper guide bearing retainer bolts (Item 1) [Figure 30-40-40].

Figure 30-40-41



Remove the swash plate bearings (Item 1) [Figure 30-40-41] from the housing.

Figure 30-40-42

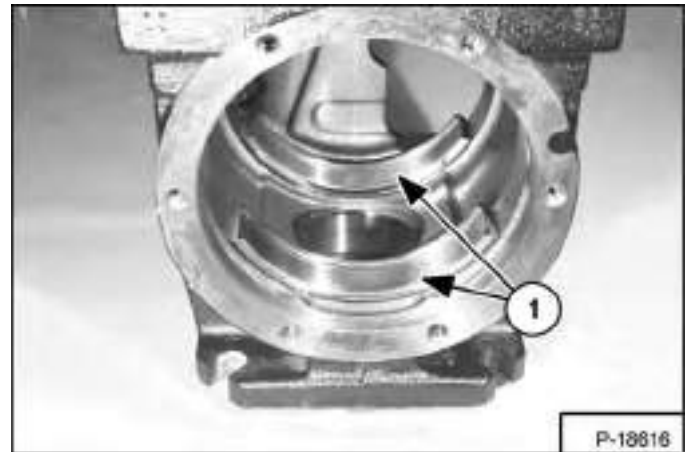

Remove the swash plate bearing races (Item 1) [Figure 30-40-42] from the housing.

Figure 30-40-43

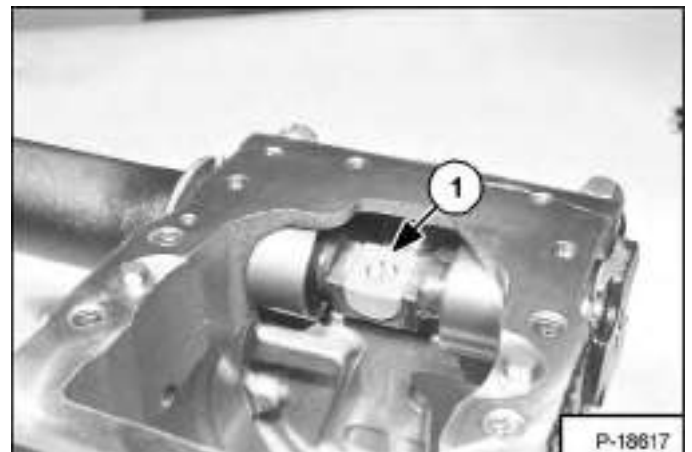

Remove the bronze slider block (Item 1) [Figure 30-40-43] from the servo piston.

Mark the position of the servo end covers.

## HYDROSTATIC PUMP (CONT'D)

### Disassembly (Cont'd)

Figure 30-40-44



Remove the three bolts and remove the servo end cover. Remove and discard both O-rings (Item 1) [Figure 30-40-44].

Figure 30-40-45

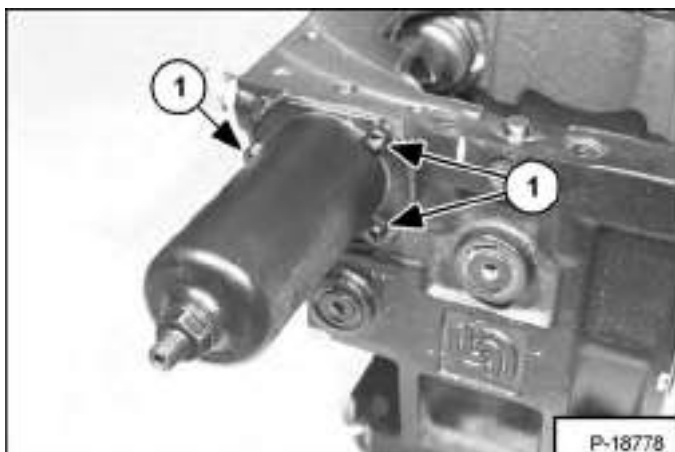

Remove the three screws (Item 1) [Figure 30-40-45] and remove the servo adjustment cover.

Figure 30-40-46



Measure and record the adjustment setting for approximate installation adjustment [Figure 30-40-46].

Figure 30-40-47

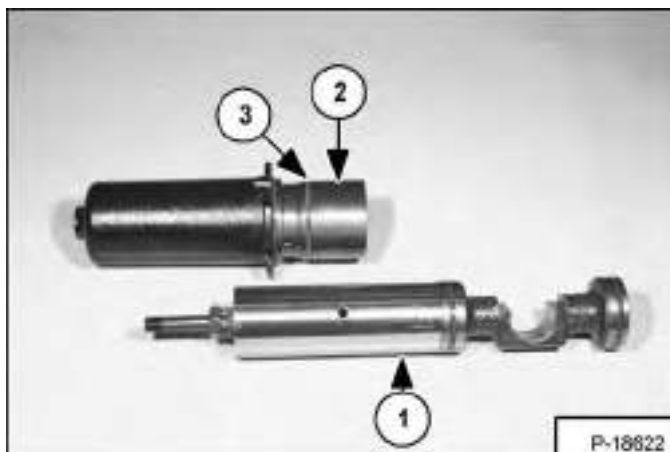

Remove the servo piston (Item 1) from the housing (Item 2) [Figure 30-40-47].

Remove and discard the O-ring (Item 3) [Figure 30-40-47].

## HYDROSTATIC PUMP (CONT'D)

### Inspection

Clean all parts in solvent and use air pressure to dry them. DO NOT use cloth or paper as small pieces of material can get into the system and cause damage.

**Figure 30-40-48**

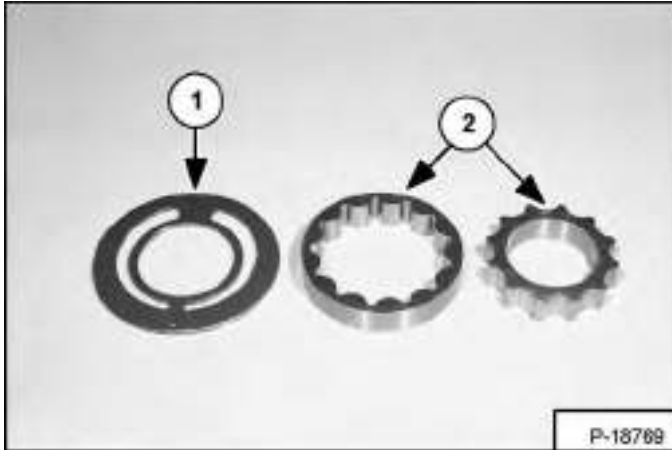

Check the wear plate (Item 1) and charge pump gears (Item 2) [Figure 30-40-48] for damage or wear.

**Figure 30-40-49**



Check the valve plate [Figure 30-40-49], the surface must be smooth and free of scratches. If scratches can be felt with a finger nail, replace the part.

**Figure 30-40-50**

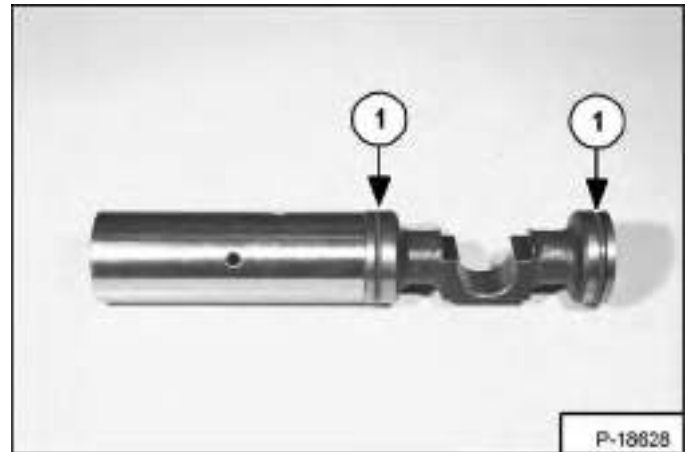

Inspect the servo piston and seal rings (Item 1) [Figure 30-40-50] for wear. If worn, remove the seal rings and expander O-rings from the piston.

Install new expander O-rings into the grooves in the servo piston. Carefully install the piston seal rings over the expander rings. Do not overstretch the piston seal rings.

**Figure 30-40-51**

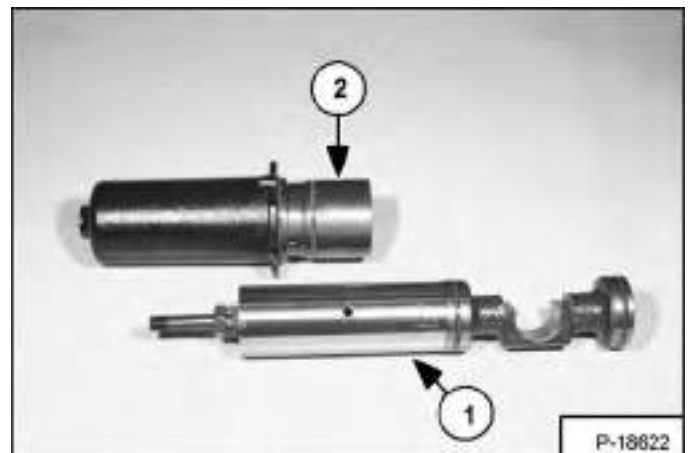

Lubricate the seal rings and carefully slide the servo piston (Item 1) into the cylinder (Item 2) [Figure 30-40-51]. Allow the assembly to set for 5 minutes to allow the seal rings to return to their original size.

## HYDROSTATIC PUMP (CONT'D)

### Inspection (Cont'd)

Figure 30-40-52

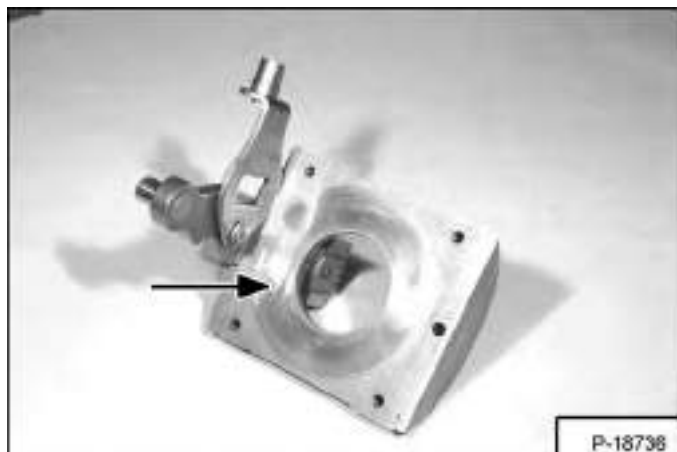

Check the swash plate assembly surface, it must be smooth and free of scratches [Figure 30-40-52].

Figure 30-40-53



Inspect the swash plate guide (Item 1) [Figure 30-40-53] for wear. Replace as needed.

**Installation:** Tighten the bolt to 24 ft.-lb. (32 N•m) torque.

Figure 30-40-54

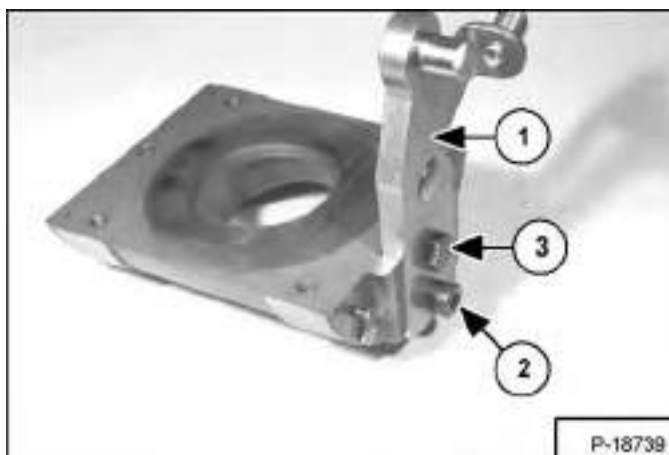

Servo arm (Item 1) [Figure 30-40-54] alignment is critical for proper pump operation. For this reason, removal of the servo arm from the swash plate is not recommended.

If the servo arm must be removed from the swash plate. Remove the swash plate guide bolt (Item 2) and the servo arm mounting bolt (Item 3) [Figure 30-40-54].

**Installation:** The servo arm (Item 1) [Figure 30-40-54] must be carefully aligned with the slot and threaded holes in the swash plate while installing, and must be pressed completely into the swash plate slot.

Tighten the swash plate guide bolt and servo arm bolt to 24 ft.-lb. (32 N•m) torque.

Figure 30-40-55

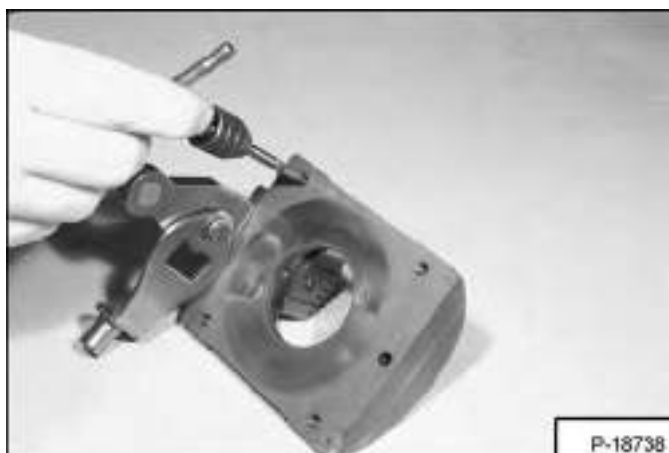

The threaded holes [Figure 30-40-55] in the swash plate must be cleaned prior to assembly.

## HYDROSTATIC PUMP (CONT'D)

### Inspection (Cont'd)

Figure 30-40-56

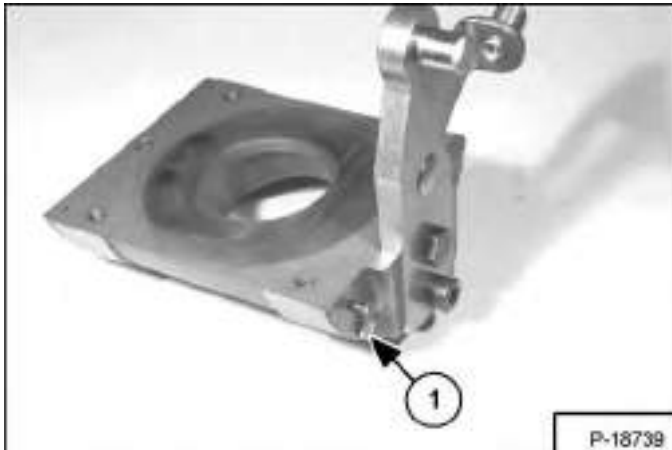
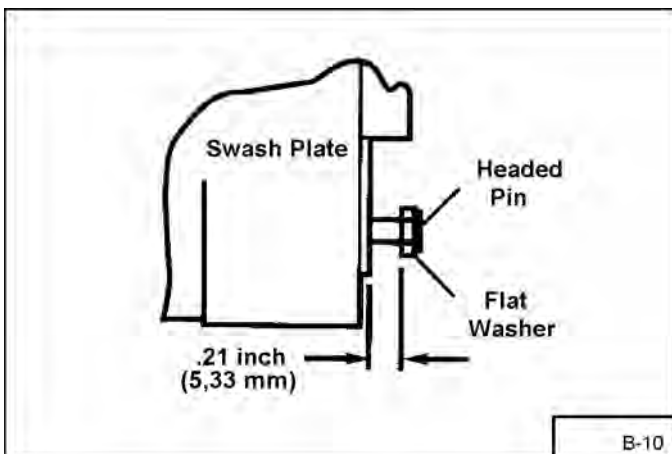

Figure 30-40-57



If the headed roll pin and flat washer (Item 1) [Figure 30-40-56] must be installed in the swash plate, the distance between the washer and the side of the swash plate must be 0.21 inch (5,33 mm) [Figure 30-40-57].

Figure 30-40-58



Check the swash plate bearings [Figure 30-40-58] for wear and damage. Replace as needed.

Figure 30-40-59

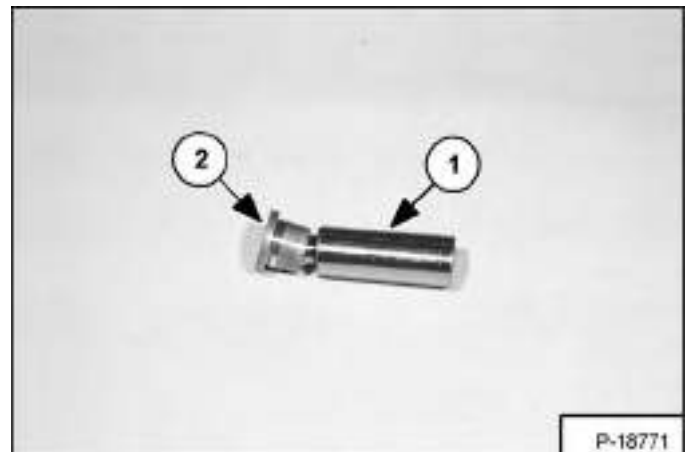

Check each piston (Item 1) and piston shoe (Item 2) [Figure 30-40-59] for wear or scratches.

## HYDROSTATIC PUMP (CONT'D)

### Inspection (Cont'd)

Figure 30-40-60



Check the cylinder block bores for wear or scratches [Figure 30-40-60].

If there is any defect in the cylinder block or pistons, the complete rotating group must be replaced.

Figure 30-40-61



Check the shaft for wear or damage in the spline and bearing areas [Figure 30-40-61].

Check the bearing for correct operation. Remove the race (Item 1) [Figure 30-40-61] from the shaft only if it is necessary to replace the bearing.

Figure 30-40-62

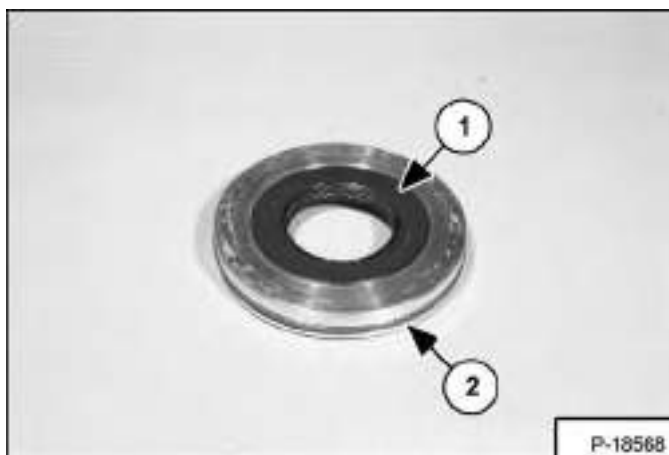

Inspect the shaft seal (Item 1) [Figure 30-40-62]. Replace if needed.

Remove and discard the O-ring (Item 2) [Figure 30-40-62].

Figure 30-40-63



Inspect the multi-function valve cartridge for damage to parts or O-rings.

Replace O-rings as needed [Figure 30-40-63].

## HYDROSTATIC PUMP (CONT'D)

### Assembly

# IMPORTANT

When repairing hydrostatic and hydraulic systems, clean the work area before disassembly and keep all parts clean. Always use caps and plugs on hoses, tubelines and ports to keep dirt out. Dirt can quickly damage the system.

I-2003-0888

Clean and lightly oil all parts prior to assembly.

Figure 30-40-64



Put the piston assemblies into the slipper guide [Figure 30-40-64].

Figure 30-40-65



Lubricate the slipper running surface on the swash plate, center the piston and guide on the swash plate [Figure 30-40-65].

Figure 30-40-66

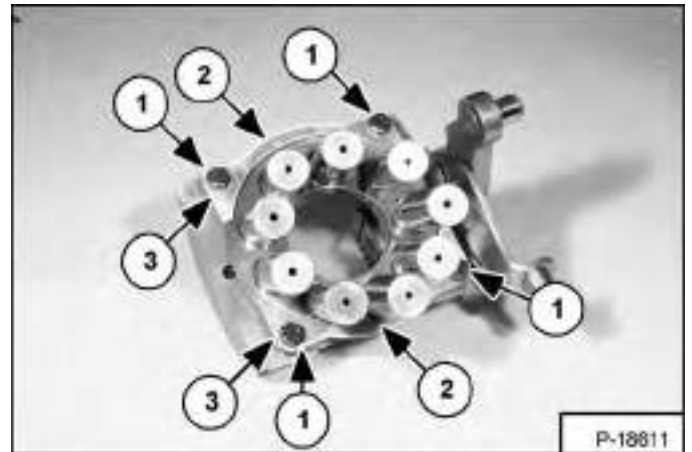

Apply LOCTITE #242 to four NEW retainer bolts (Item 1). Install the slipper guide bearings (Item 2) and spacers (Item 3) and bolts (Item 1) [Figure 30-40-66].

Tighten the four bolts to 10 ft.-lb. (13,5 N•m) torque.

**NOTE:** Always use NEW retainer bolts with proper locking compound.

**NOTE:** The slipper guides and piston slippers must slide freely on the swash plate.

Figure 30-40-67



Lubricate the pistons and cylinder block bores. Install the assembled swash plate and pistons into the cylinder block [Figure 30-40-67].

**NOTE:** The pistons and bores are not selectively fitted.

## HYDROSTATIC PUMP (CONT'D)

### Assembly (Cont'd)

Figure 30-40-68



Install the swash plate bearing races (Item 1) [Figure 30-40-68] into the housing. Note the locating pins are offset in the housing to assure proper assembly.

Figure 30-40-69

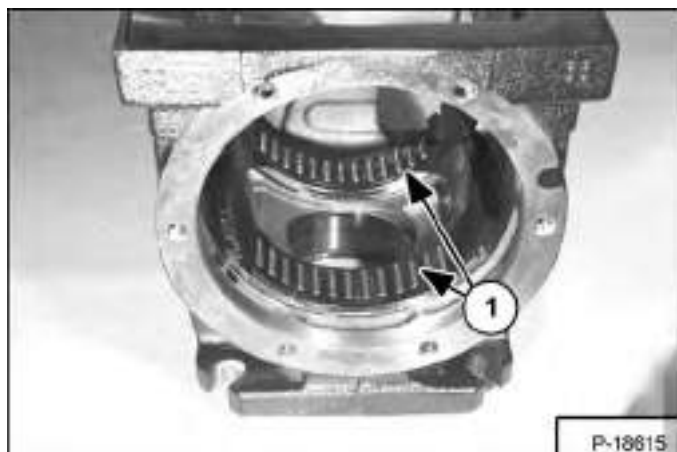

Assemble and lubricate the bearing cage (Item 1) [Figure 30-40-69], and install it on the bearing races.

Figure 30-40-70



Install the bronze slider block (Item 1) [Figure 30-40-70] on the swash plate servo arm.

Figure 30-40-71



Carefully lower the cylinder block and swash plate assembly into the housing [Figure 30-40-71].



## HYDROSTATIC PUMP (CONT'D)

### Assembly (Cont'd)

Figure 30-40-72

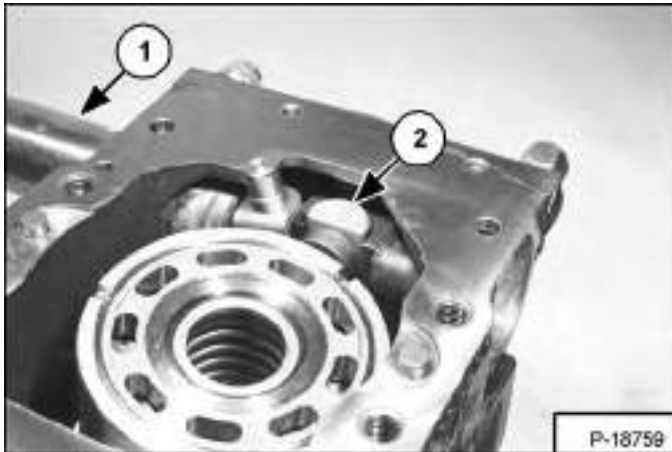

Holding the cylinder block and swash plate assembly approximately 1/2" (12 mm) above the bearings. Position the servo piston (Item 1) on the bronze slider block (Item 2) [Figure 30-40-72]. Take care not to wedge the block, the parts should slide freely.

Figure 30-40-73



Lower the cylinder block and swash plate assembly until the swash plate is properly located on the bearings [Figure 30-40-73].

Figure 30-40-74

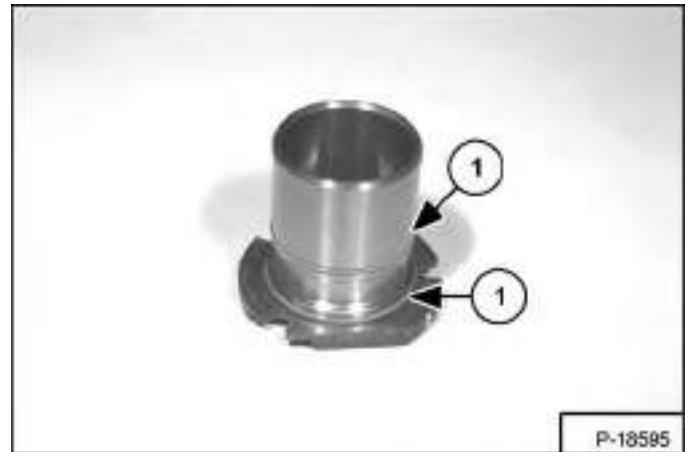

Install new O-rings (Item 1) [Figure 30-40-74] on the servo end cap.

Lightly lubricate the O-rings and the inner surface of the end cap.

Figure 30-40-75



Hold the servo piston in position and install the servo end cap [Figure 30-40-75].

## HYDROSTATIC PUMP (CONT'D)

### Assembly (Cont'd)

Figure 30-40-76

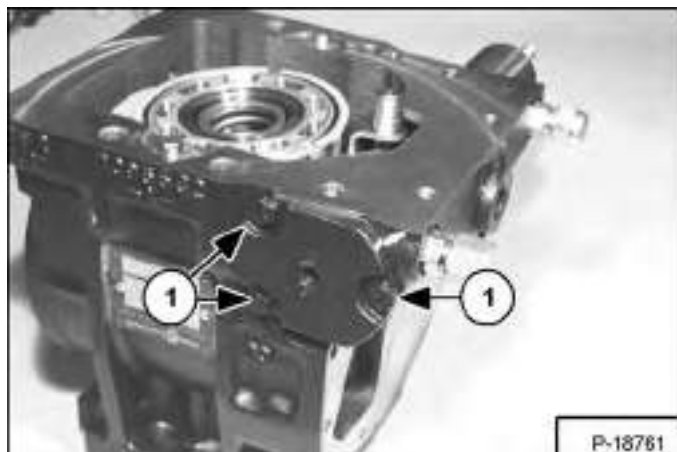

Install the three end cap mounting bolts (Item 1) [Figure 30-40-76]. Tighten to 10 ft.-lb. (13,5 N•m) torque.

Lightly lubricate the O-rings and inner surface of the adjustment cover.

Figure 30-40-77



Install the servo adjustment cover over the servo piston until the piston adjustment screw touches the cover. Using a hex wrench, turn the adjustment screw counterclockwise while holding the cover until it is in position [Figure 30-40-77].

**NOTE: Do not install the bolts at this time.**

Figure 30-40-78

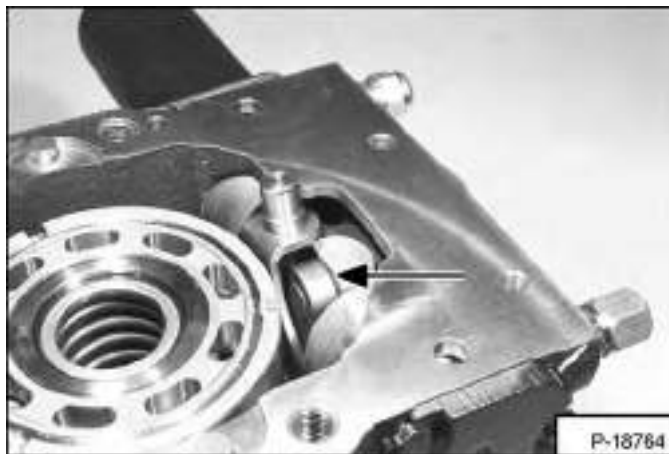

Push the swash plate assembly toward the servo piston until the swash plate guide contacts the bearing races. Check for clearance between the servo arm and the slider block [Figure 30-40-78]. If no clearance is present, recheck the assembly of the bearing cage and races.

Figure 30-40-79

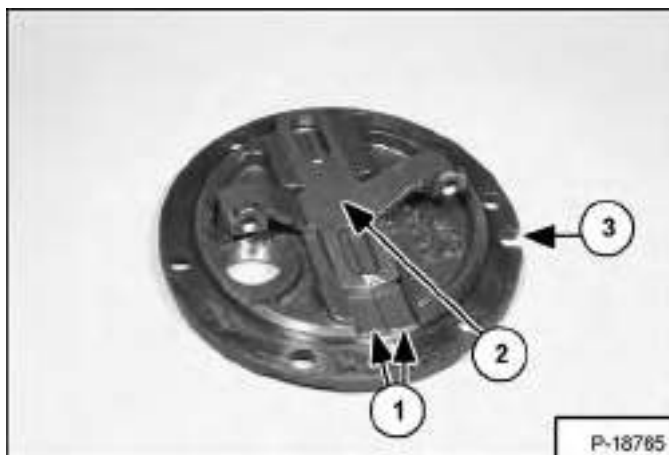

Position the two side cover inserts (Item 1) and swash plate leveler (Item 2) on the side cover. Note the orientation of the leveler and the notch (Item 3) [Figure 30-40-79] in the cover.

## HYDROSTATIC PUMP (CONT'D)

### Assembly (Cont'd)

Figure 30-40-80

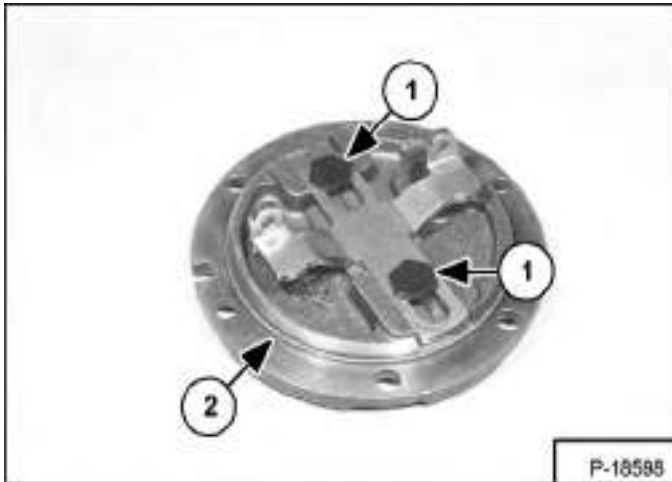

Install the two guide post bolts (Item 1) [Figure 30-40-80] through the lever and inserts. Install the sealing nuts and tighten to 17 ft.-lb. (23 N•m) torque.

Install a new O-ring (Item 2) [Figure 30-40-80] on the cover.

Figure 30-40-81



Lift the swash plate leveler and install the side cover [Figure 30-40-81].

Figure 30-40-82

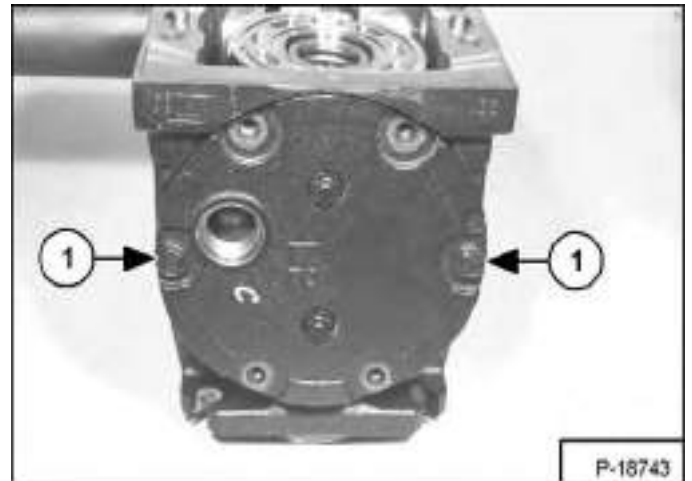

Install the two side cover bolts (Item 1) [Figure 30-40-82] finger tight.

Apply a force of 5 - 10 ft.-lb. (22 - 44 N•m) to the swash plate leveler to make sure both lever arms contact the swash plate.

Make sure the swash plate assembly is seated correctly on the bearings.

Figure 30-40-83

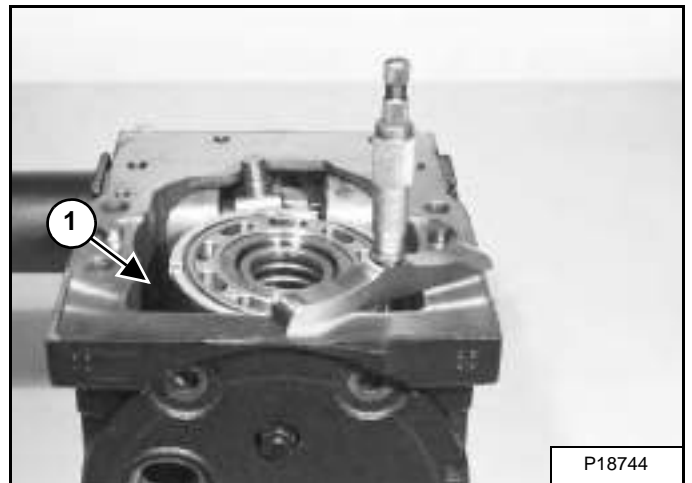

Use a depth micrometer to measure the distance from the end cap to the swash plate surface. Take a second measurement at a point 90° (Item 1) [Figure 30-40-83] from the first point of measurement. These measurements must not vary more than 0.001 inches (0,025 mm).

## HYDROSTATIC PUMP (CONT'D)

### Assembly (Cont'd)

Figure 30-40-84



Rotate the side cover [Figure 30-40-84] (which will also rotate the leveler and swash plate) until the zero angle position is established, as determined by a second depth measurement.

Figure 30-40-85

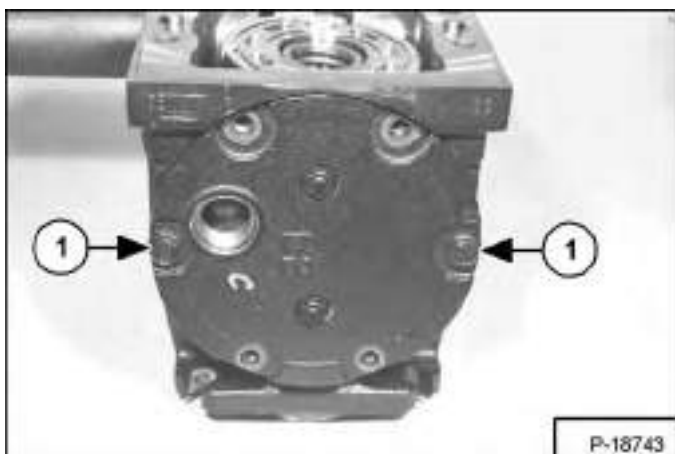

After the zero angle position has been established, tighten the two side cover bolts (Item 1) [Figure 30-40-85].

Figure 30-40-86

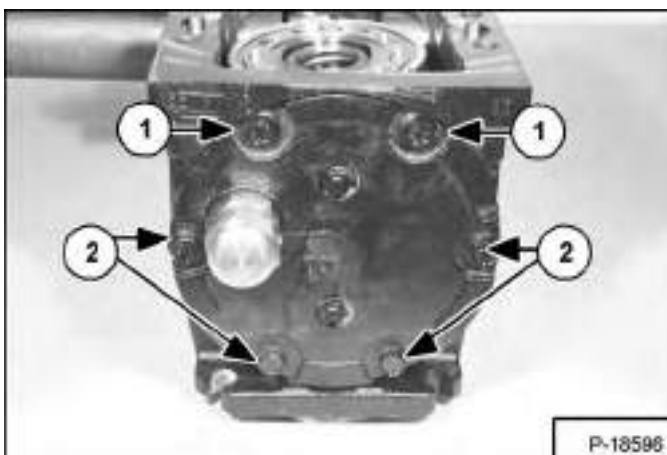

Install the four remaining side cover bolts, apply LOCTITE #242 to the threads of the "thru" bolts (Item 1) [Figure 30-40-86].

First tighten the four side cover bolts (Item 2) to 24 ft.-lb. (32,5 N•m) torque. Tighten the two remaining side cover bolts (Item 1) [Figure 30-40-86] to 18.5 ft.-lb. (25 N•m) torque.

Figure 30-40-87

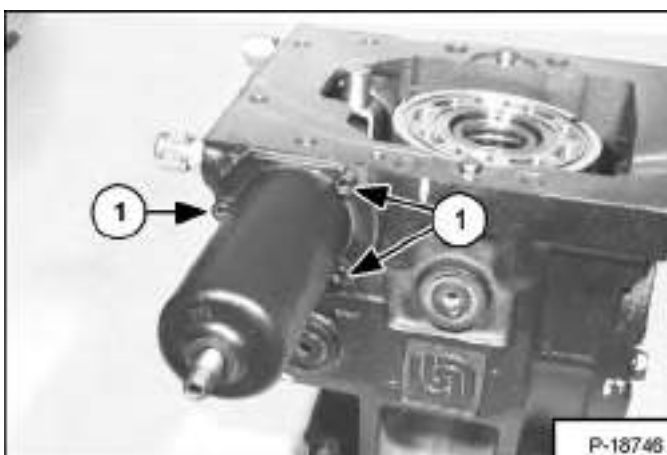

Install the three servo adjustment cover mounting screws (Item 1) [Figure 30-40-87]. Tighten to 10 ft.-lb. (13,5 N•m) torque.

## HYDROSTATIC PUMP (CONT'D)

### Assembly (Cont'd)

Figure 30-40-88



Turn the adjustment screw on the servo, which will rotate the swash plate assembly until a zero angle position is established [Figure 30-40-88].

Figure 30-40-89

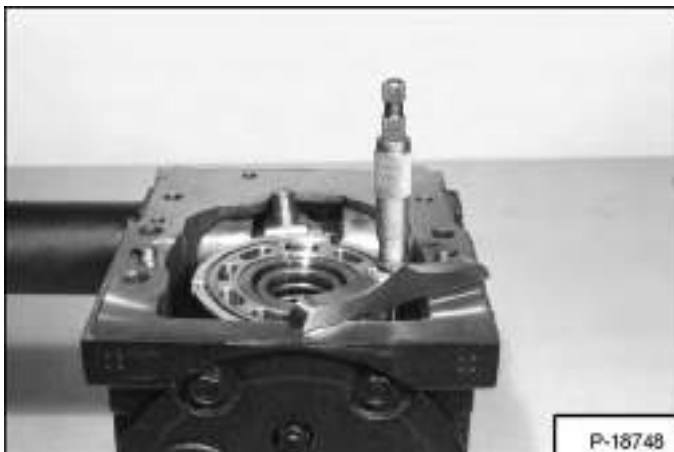

Use a depth micrometer to measure the distance from the end cap to the swash plate surface [Figure 30-40-89]. Take a second measurement at a point 180° from the first point of measurement. These measurements must not vary more than 0.001 inch (0,025 mm).

Figure 30-40-90

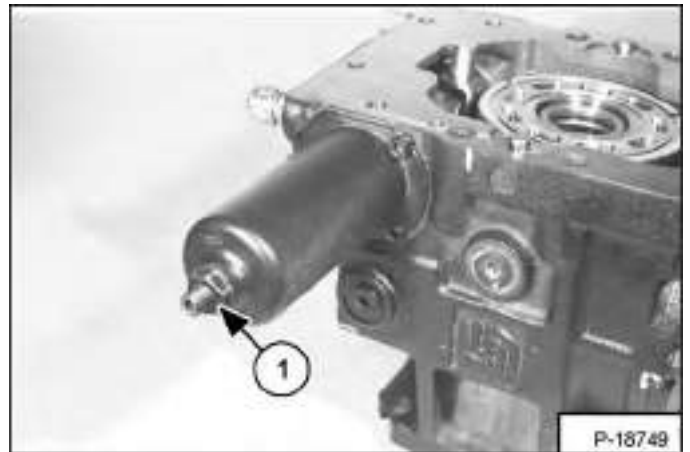

Without turning the servo adjustment screw, install the sealed nut (Item 1) [Figure 30-40-90] and tighten.

Figure 30-40-91

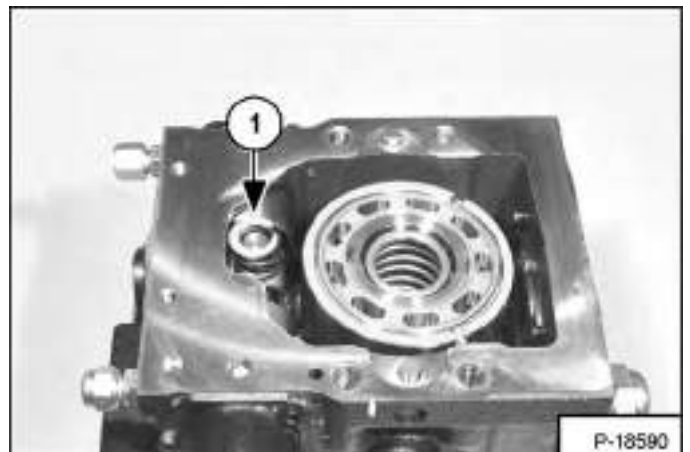

Install the spring (Item 1) [Figure 30-40-91] on the servo arm link.

## HYDROSTATIC PUMP (CONT'D)

### Assembly (Cont'd)

Figure 30-40-92

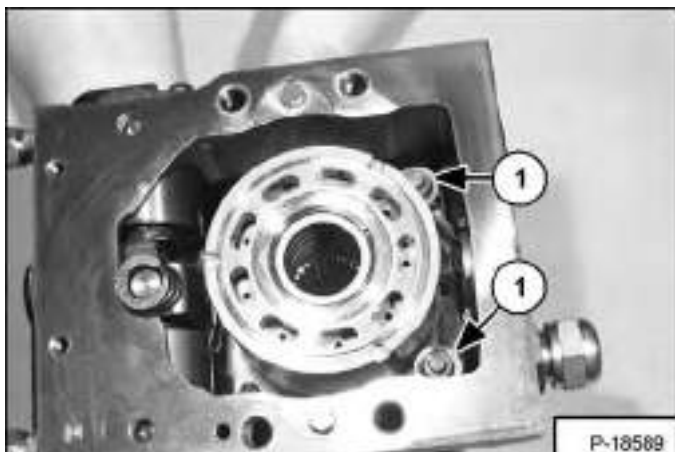

Install the spring seats (Item 1) [Figure 30-40-92] on the lever arms.

Figure 30-40-93

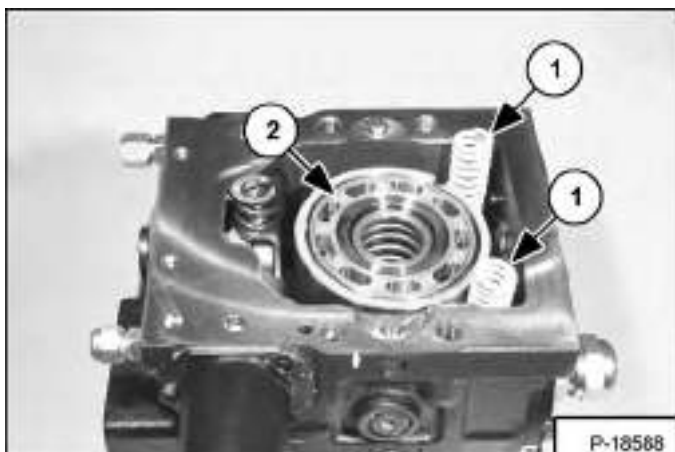

Install both springs (Item 1) [Figure 30-40-93] on the lever spring seats.

Lubricate the running surface of the cylinder (Item 2) [Figure 30-40-93].

Figure 30-40-94

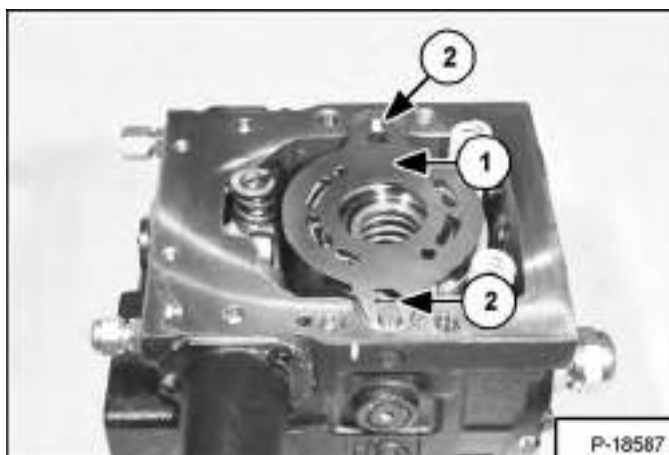

Install the valve plate (Item 1) [Figure 30-40-94] on the alignment pins.

**NOTE:** Ensure the direction of the arrow cut outs (Item 2) [Figure 30-40-94] in the valve plate are positioned as shown.

Figure 30-40-95

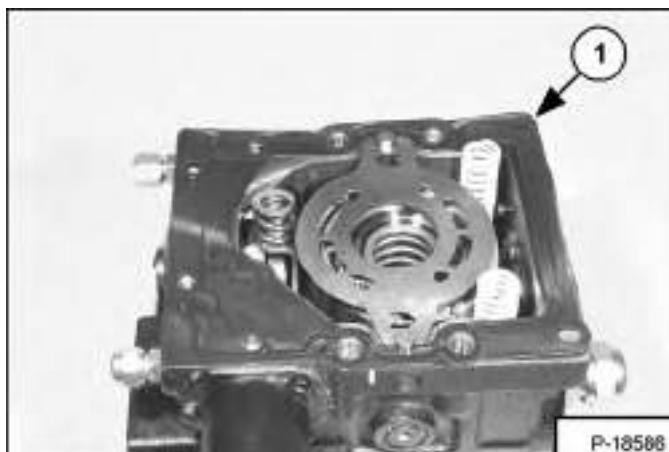

Install a new gasket (Item 1) [Figure 30-40-95] on the housing.

## HYDROSTATIC PUMP (CONT'D)

### Assembly (Cont'd)

Figure 30-40-96

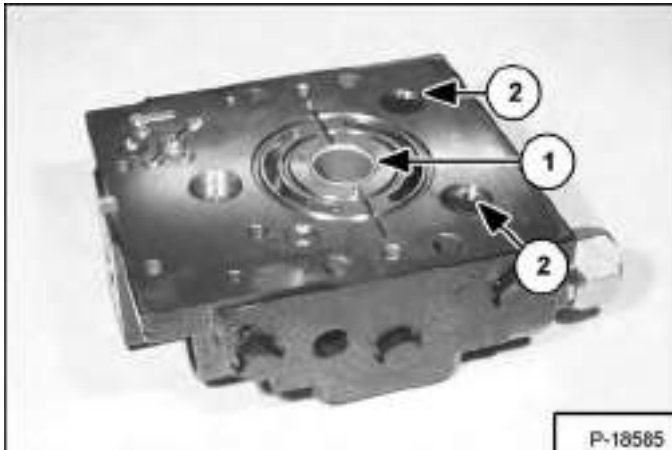

Lubricate the end cap journal bearing (Item 1). Install the hardened shims (Item 2) [Figure 30-40-96] in the charge pump pockets for the swash plate leveler springs. Retain the shims with assembly lube.

Turn the charge pump housing over.

Figure 30-40-97

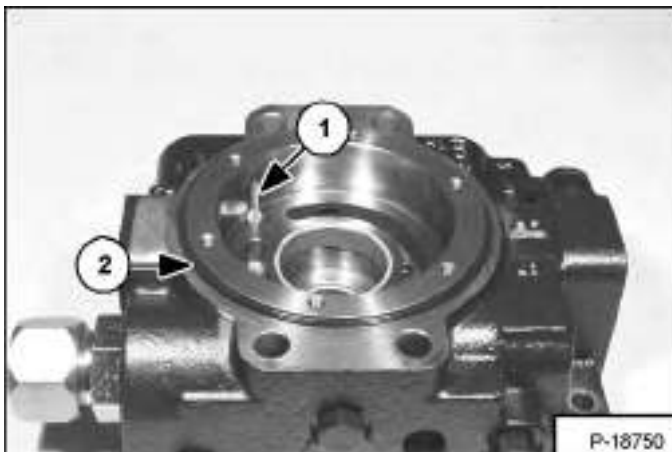

Lightly lubricate the alignment pin (Item 1) [Figure 30-40-97] and install into the charge pump housing, in the position marked at time of disassembly. This will properly align the wear plate and eccentric ring.

Install a new O-ring (Item 2) [Figure 30-40-97].

Figure 30-40-98

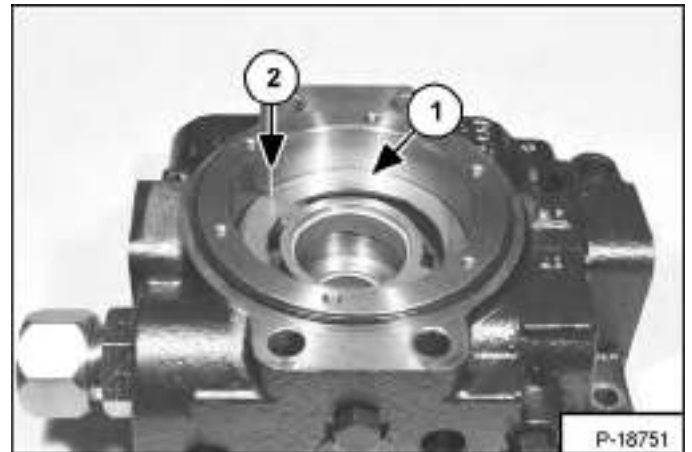

Lubricate both sides of the wear plate (Item 1) and install in the charge pump. Align the wear plate with the alignment pin (Item 2) [Figure 30-40-98].

Figure 30-40-99

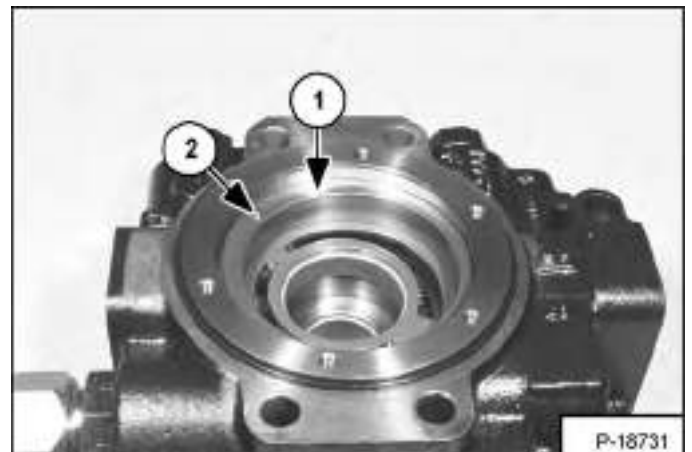

Install the eccentric ring (Item 1) in the charge pump and align with the alignment pin (Item 2) [Figure 30-40-99].

## HYDROSTATIC PUMP (CONT'D)

### Assembly (Cont'd)

Figure 30-40-100

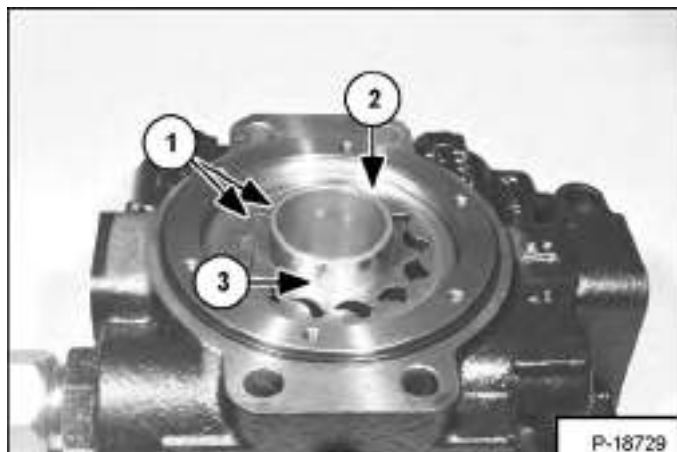

Apply assembly lube and install the charge pump gears (Item 1), charge pump shaft (Item 2) and key (Item 3) [Figure 30-40-100] into the pump.

Figure 30-40-101

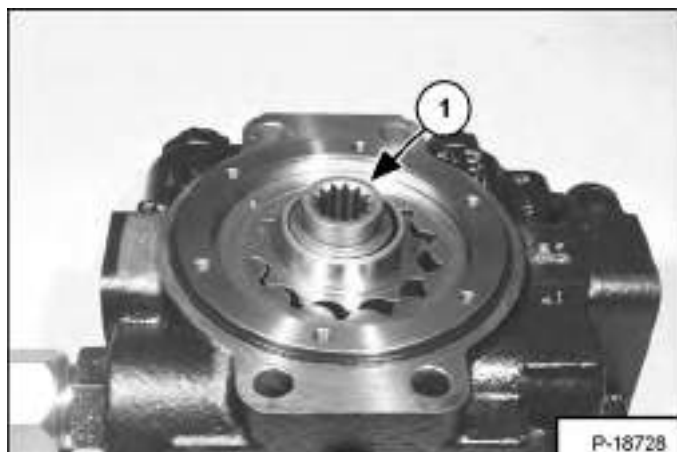

Install the coupler (Item 1) [Figure 30-40-101].

Figure 30-40-102

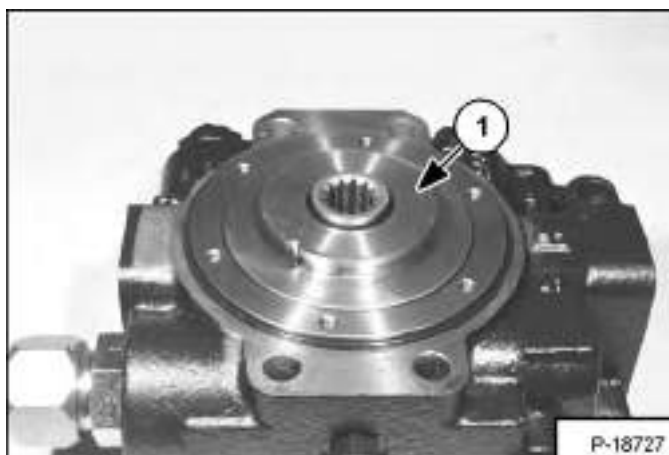

Install the charge pump cover (Item 1) [Figure 30-40-102].

Rotate until pin hole in cover aligns with the pin.

Figure 30-40-103

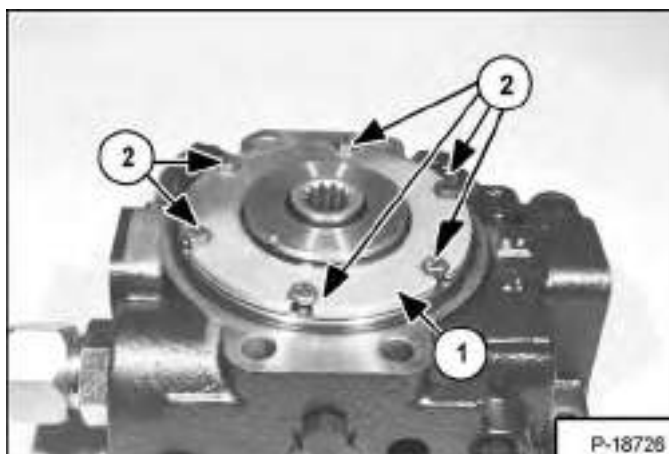

Install the retaining plate cover (Item 1) and six bolts (Item 2) [Figure 30-40-103]. Tighten the bolts to 10 ft.-lb. (13,5 N•m) torque.



## HYDROSTATIC PUMP (CONT'D)

### Assembly (Cont'd)

Figure 30-40-104

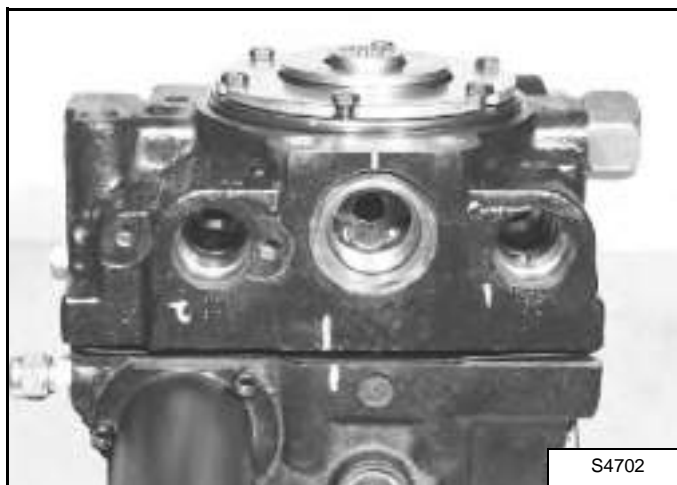

Lower the charge pump onto the pump housing while positioning the three springs in their pockets [Figure 30-40-104].

When properly installed, the charge pump will engage the alignment pins, but the springs will hold the charge pump housing 1/8 to 1/4 (3 to 8 mm) away from the pump housing.

Figure 30-40-105

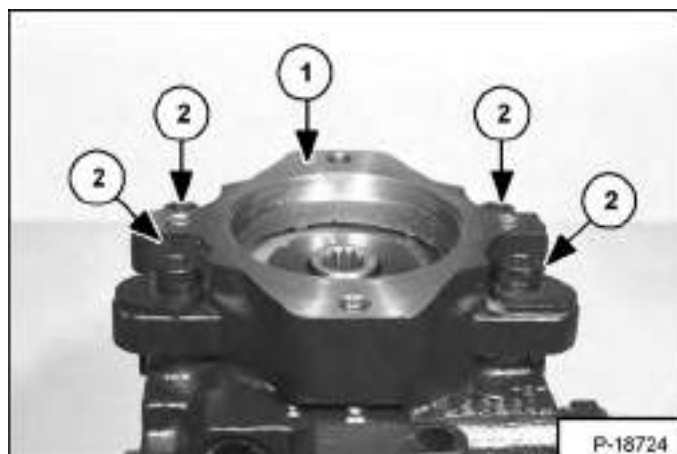

Install the flange adapter (Item 1) and four bolts (Item 2) [Figure 30-40-105]. Tighten the bolts to 90 ft.-lb. (122 N•m) torque.

Figure 30-40-106

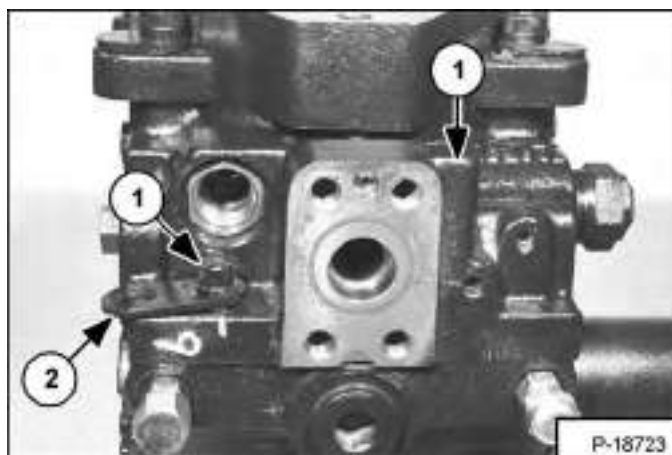

Install the two mounting bolts (Item 1) [Figure 30-40-106] and tighten to 28 ft.-lb. (38 N•m) torque.

**NOTE:** Install the lifting bracket (Item 2) [Figure 30-40-106].

Figure 30-40-107

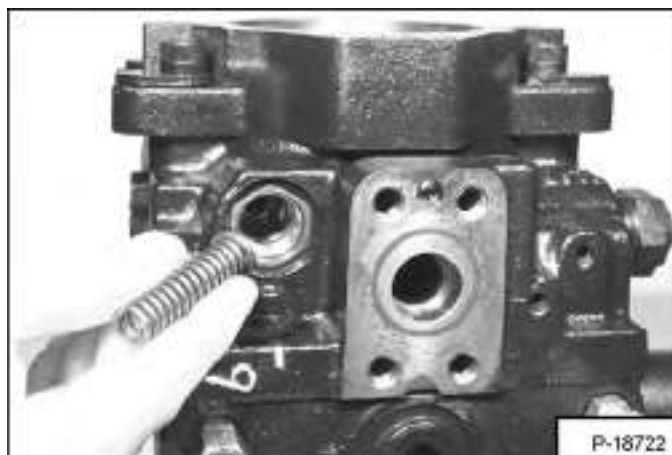

Install the spring and relief poppet into the charge pump [Figure 30-40-107].

## HYDROSTATIC PUMP (CONT'D)

### Assembly (Cont'd)

Figure 30-40-108

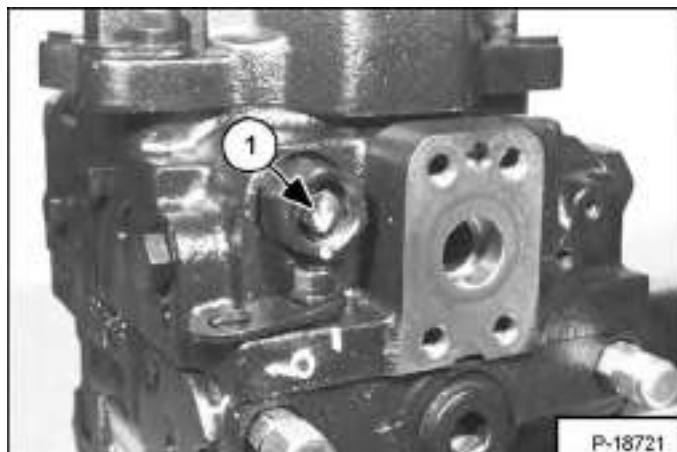

Install the plug with lock nut (Item 1) [Figure 30-40-108], align the marks made at disassembly. Tighten the lock nut to 38 ft.-lb. (52 N•m) torque.

Figure 30-40-109

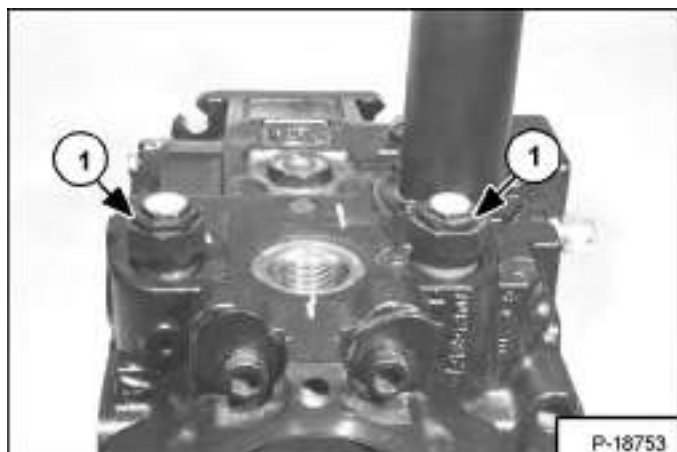

Lightly lubricate and install both multi-function valve assemblies (Item 1) [Figure 30-40-109] in the charge pump. Tighten to 66 ft.-lb. (89 N•m) torque.

Figure 30-40-110

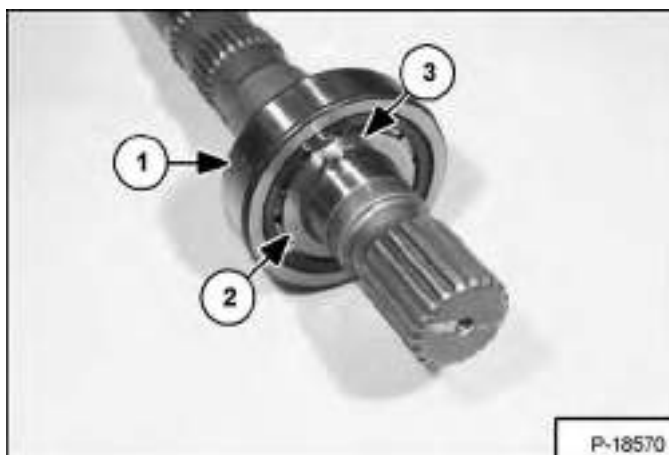

Install the bearing (Item 1), the spacer washer (Item 2) and the snap ring (Item 3) [Figure 30-40-110] on the drive shaft.

Position the pump on the charge pump end.

Figure 30-40-111



Install the shaft and bearing assembly, aligning the shaft spline with the cylinder block spline. Continue to lower the shaft and align with the charge pump journal bearing and charge pump coupler [Figure 30-40-111].

## HYDROSTATIC PUMP (CONT'D)

### Assembly (Cont'd)

Figure 30-40-112

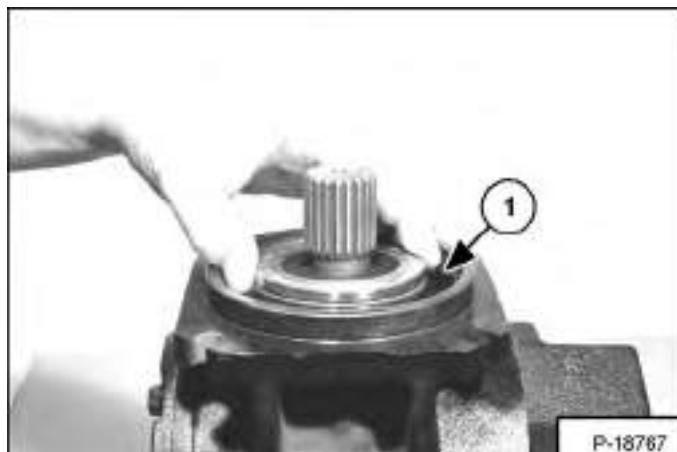

Install a new O-ring (Item 1) [Figure 30-40-112].

Lubricate the seal with assembly lube and install the seal assembly on the drive shaft and in the housing [Figure 30-40-111].

Figure 30-40-113

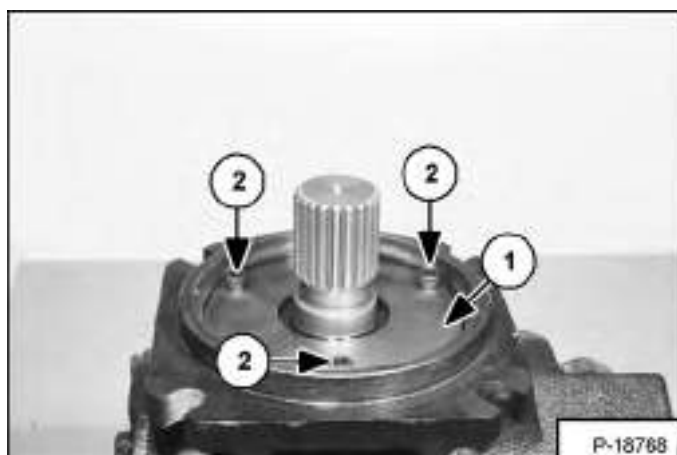

Install the retainer plate (Item 1) and three screws (Item 2) [Figure 30-40-113]. Tighten the screws in a sequenced pattern to 12 ft.-lb. (16 N•m) torque.

Figure 30-40-114

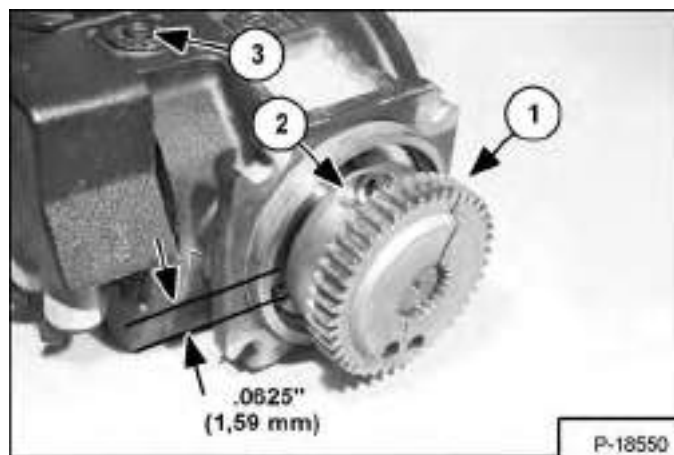

Install the coupler gear (Item 1) on the shaft and install the bolt (Item 2) [Figure 30-40-114].

Figure 30-40-115

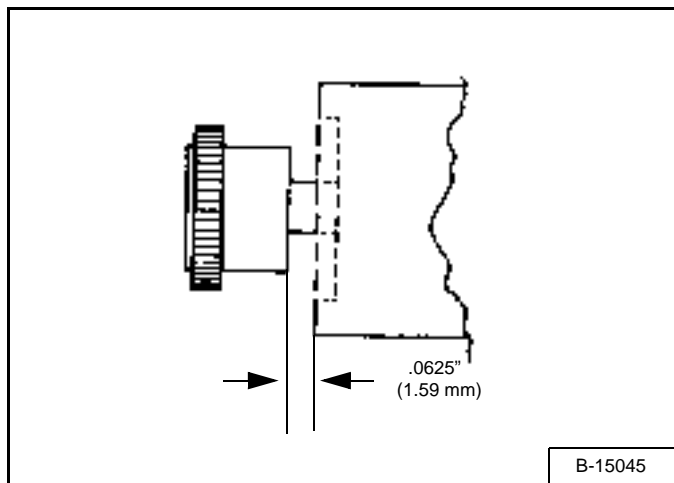

**NOTE:** When installing the coupler, maintain a 0.337 inch (8,56 mm) gap from the pump mount flange to the coupler [Figure 30-40-114] & [Figure 30-40-115].

Remove the case plug (Item 3) [Figure 30-40-114] and fill with clean hydraulic fluid prior to start up. Rotate the pump shaft with a torque wrench to assure correct assembly. The torque required to turn the shaft (after "break away") should be within:

Minimum	Maximum
4 ft.-lb. (5,4 N•m)	9 ft.-lb. (12,2 N•m)



**Bobcat®**

---

## DRIVE SYSTEM

AXLE AND DIFFERENTIAL (REAR) . . . . .	40-21-1
Bevel pinion Assembly . . . . .	40-21-18
Bevel pinion Disassembly . . . . .	40-21-15
Differential and Bevel Pinion Parts Identification . . . . .	40-21-10
Differential Assembly . . . . .	40-21-26
Differential Disassembly . . . . .	40-21-11
General Information . . . . .	40-21-1
Planetary Carrier Assembly . . . . .	40-21-34
Planetary Carrier Parts Identification . . . . .	40-21-1
Steering Knuckle Assembly . . . . .	40-21-31
Steering Knuckle and Drive Axle Parts Identification . . . . .	40-21-7
Special tools . . . . .	40-21-38
Steering Knuckle Disassembly . . . . .	40-21-8
AXLE AND DIFFERENTIAL (FRONT) . . . . .	40-20-1
General Information . . . . .	40-20-1
Planetary Carrier Disassembly . . . . .	40-20-2
Steering Knuckle Disassembly . . . . .	40-20-8
Drive Axle Disassembly . . . . .	40-20-10
Brake System Disassembly . . . . .	40-20-13
Differential Disassembly . . . . .	40-20-18
Bevel Pinion Disassembly . . . . .	40-20-24
Bevel Pinion Assembly . . . . .	40-20-27
Differential assembly . . . . .	40-20-36
Brake System Assembly . . . . .	40-20-41
Drive Axle Assembly . . . . .	40-20-48
Steering Knuckle Assembly . . . . .	40-20-50
Planetary carrier Assembly . . . . .	40-20-53
AXLE TOE-IN . . . . .	40-40-1
Adjustment . . . . .	40-40-1
DRIVESHAFT . . . . .	40-70-1
Removal And Installation . . . . .	40-70-1
FRONT AXLE . . . . .	40-30-1
Removal . . . . .	40-30-1
PARKING BRAKE . . . . .	40-50-1
Re-Activating The Brake . . . . .	40-50-2
Releasing The Brake For Towing . . . . .	40-50-1
REAR AXLE . . . . .	40-90-1
Removal . . . . .	40-90-1

Continued On Next Page

**DRIVE SYSTEM**

---

## DRIVE SYSTEM (CONT'D)

SERVICE BRAKE . . . . .	40-80-1
Bleeding The Brake Circuit . . . . .	40-80-1
Description. . . . .	40-80-1
STEERING ANGLE ADJUSTMENT . . . . .	40-60-1
Adjustment. . . . .	40-60-1
TROUBLESHOOTING . . . . .	40-10-1
Chart . . . . .	40-10-1

## TROUBLESHOOTING

### Chart

The following Troubleshooting Chart is provided for assistance in locating and correcting problems which are most common. Many of the recommended procedures must be done by authorized Bobcat Service Personnel only.

PROBLEM	CAUSE
Pinion or Ring gear tooth broken	1, 2, 3, 4, 5, 6
Pinion teeth pitted	5, 11
Axle housing bent	12, 13
Worn or pitted bearings	3, 5, 6, 8, 11, 14
Oil leakage	6, 9, 10, 14, 15
Excessive wear on input shaft splines	3, 16, 17, 19
Pinion teeth fatigue	7, 12, 17, 19
Side gear spline worn	17, 19
Thrust washer surface worn	5, 6, 7
Inner diameter of tapered roller bearing worn	5, 6, 18, 19
Bent or broken half shaft	19
Half shaft broken at wheel side	20, 21

KEY TO CORRECT THE CAUSE
1. Excessive gear load
2. Incorrect gear adjustment (excessive play)
3. Pinion nut loose
4. Incorrect gear adjustment (insufficient play)
5. Insufficient lubrication
6. Contaminated oil
7. Incorrect lubrication
8. Worn bearings
9. Operation at high temperature
10. Low oil level
11. Excessive use
12. Overloaded
13. Accident
14. Normal Wear
15. Lip seal damaged
16. Pinion axle play
17. Continuous overload
18. Excessive pinion axle play
19. Vehicle intensively operated or overloaded
20. Wheel loose
21. Beam housing bent



**Bobcat®**



## AXLE AND DIFFERENTIAL (FRONT)

### General Information

For photo clarity, the following axle procedures are done with the complete axle assembly removed from the machine, although the planetary carrier, wheel hub, steering knuckle and drive axle procedures may be done with the axle assembly installed in the machine. For complete axle repair, the following must be done.

- Front Axle removal. (See "Removal" on page 40-30-1.)
- Front steering cylinder removal. (See "Removing the Steering Cylinder" on page 20-60-1.)

### Planetary Carrier Parts Identification

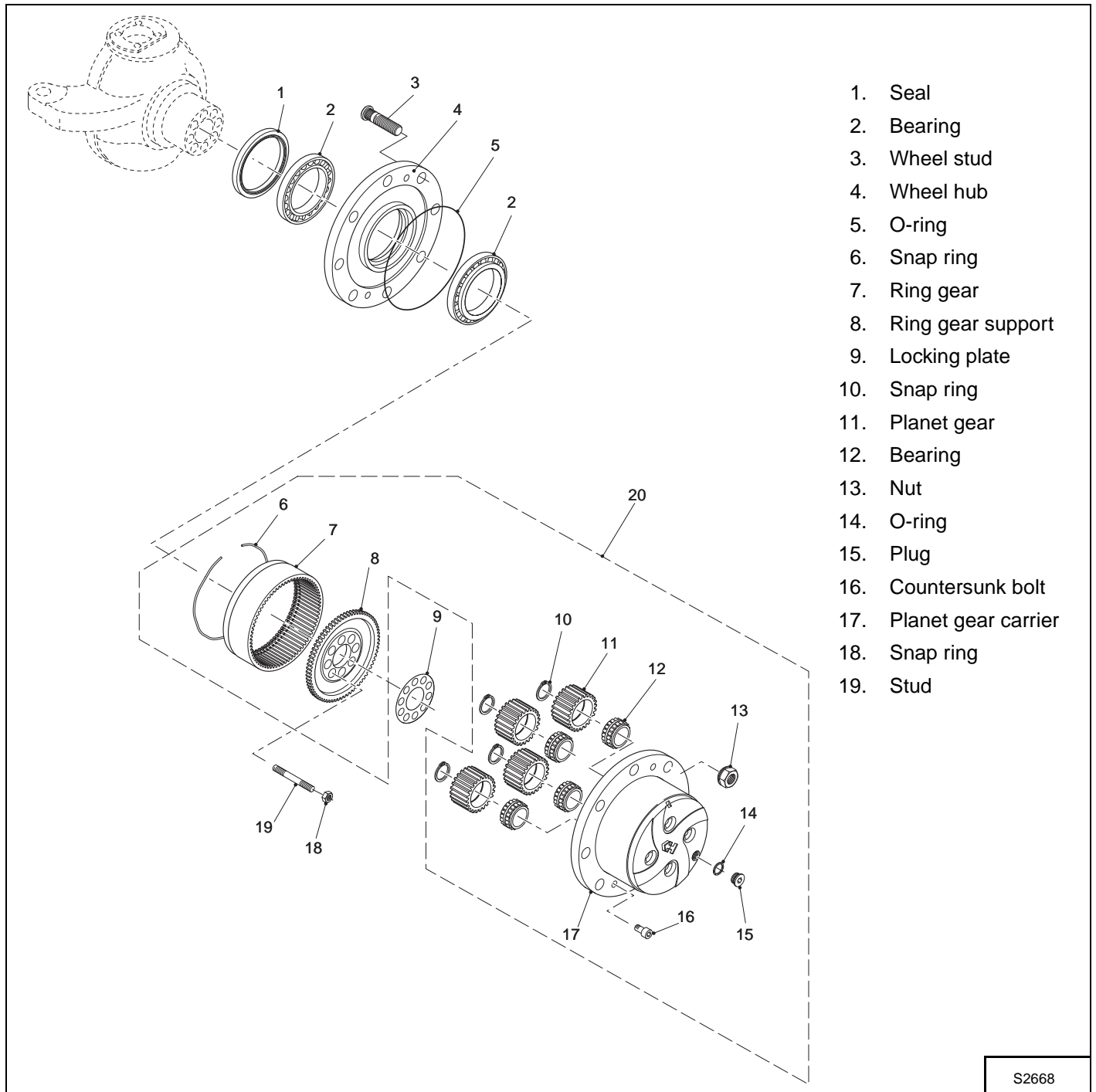

S2668

## AXLE AND DIFFERENTIAL (FRONT) (CONT'D)

### Planetary Carrier Disassembly

Figure 40-20-1

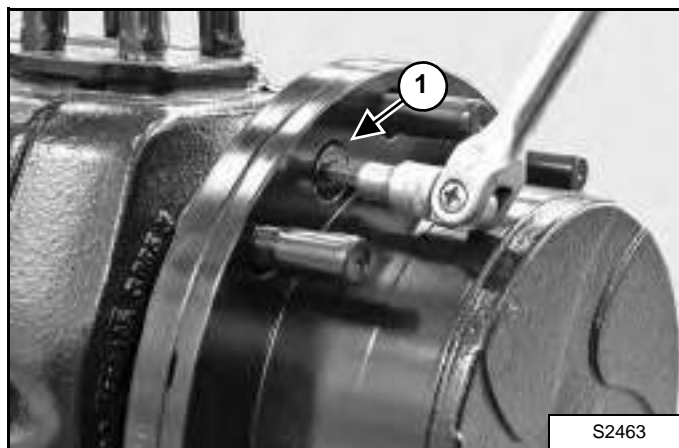

Loosen the securing bolts (Item 1) [Figure 40-20-1] only so that later when you pry the planet gear carrier loose, it does not fall.

Figure 40-20-2

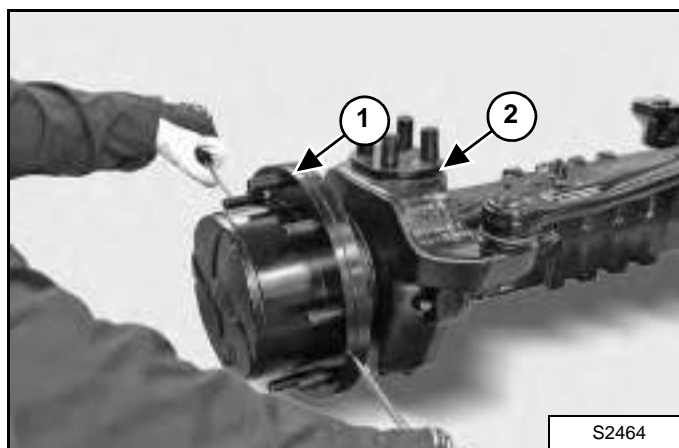

Remove the planet gear carrier (Item 1) from the steering case (Item 2) [Figure 40-20-2] by alternatively forcing a screwdriver into the appropriate slots.

Figure 40-20-3

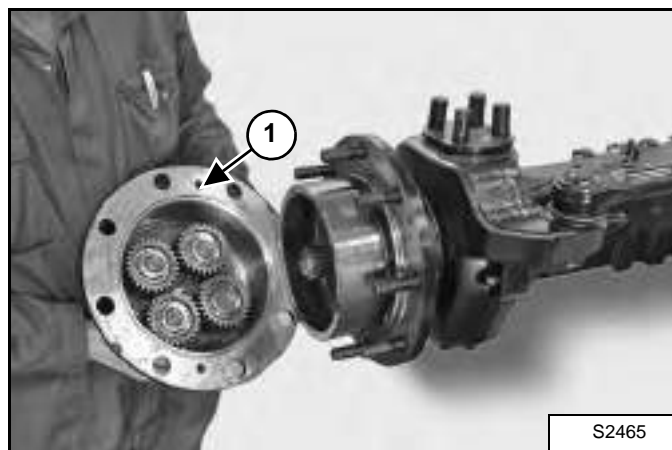

Remove the securing bolts and lift the planet gear carrier (Item 1) [Figure 40-20-3].

Figure 40-20-4

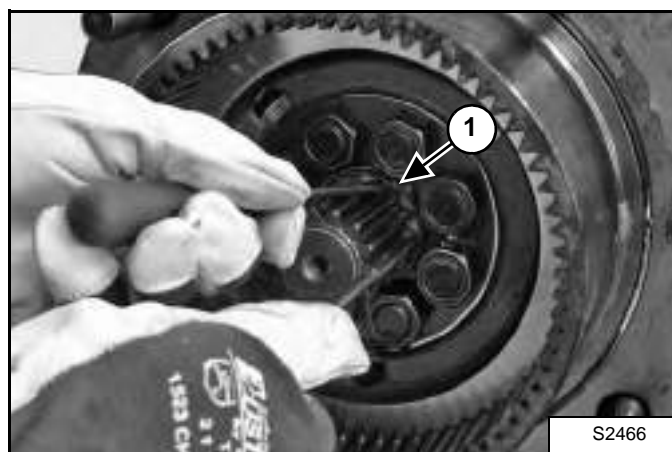

Remove the snap ring (Item 1) [Figure 40-20-4].

## AXLE AND DIFFERENTIAL (FRONT) (CONT'D)

### Planetary Carrier Disassembly (Cont'd)

Figure 40-20-5

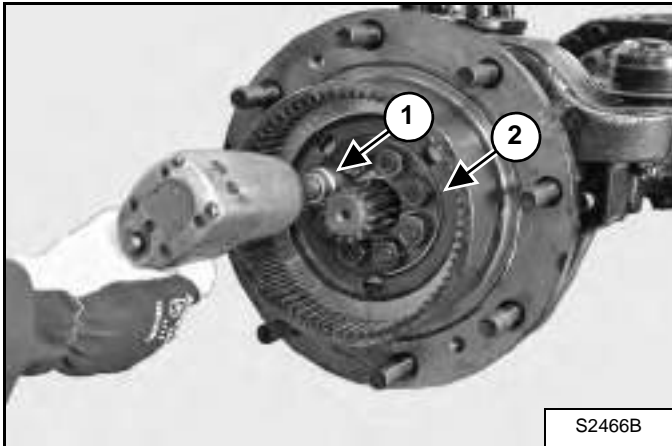

Remove the nuts (Item 1) from the ring gear support (Item 2) [Figure 40-20-5].

Figure 40-20-6

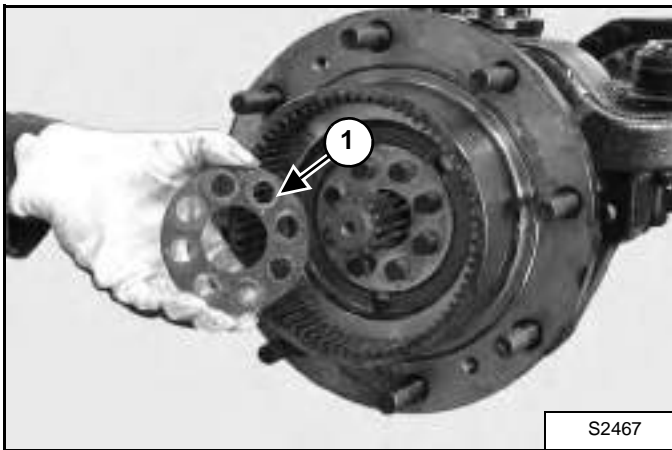

Remove the locking plate (Item 1) [Figure 40-20-6].

Figure 40-20-7

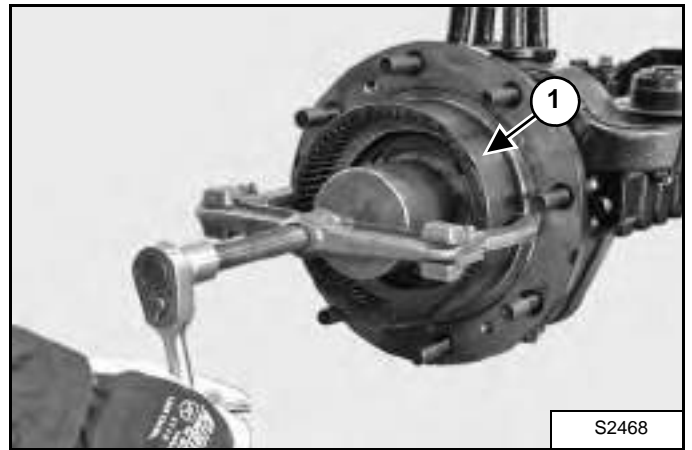

Using a puller, remove the complete ring gear (Item 1) [Figure 40-20-7] by acting on the stud bolts.

Figure 40-20-8

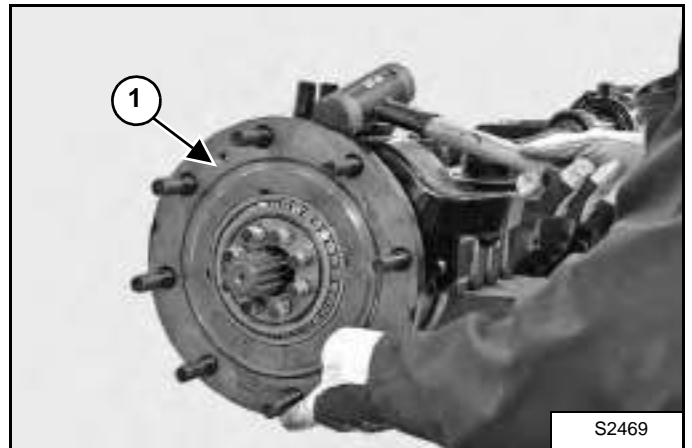

Partially extract the wheel hub (Item 1) [Figure 40-20-8] using a plastic hammer.

**NOTE: Alternately hammer on several equidistant points.**

## AXLE AND DIFFERENTIAL (FRONT) (CONT'D)

### Planetary Carrier Disassembly (Cont'd)

Figure 40-20-9

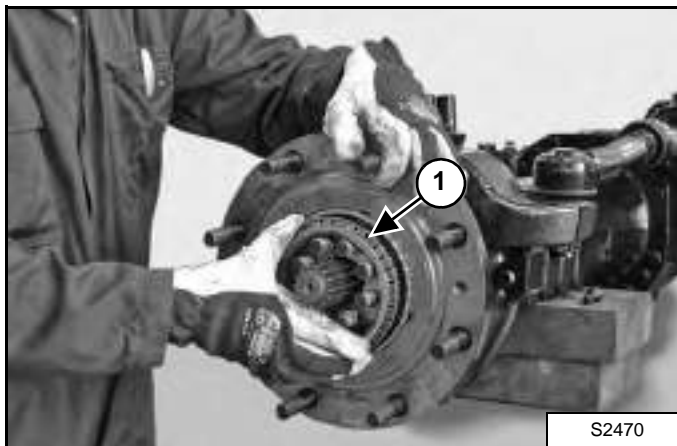

Remove the external bearing (Item 1) [Figure 40-20-9].

Figure 40-20-10

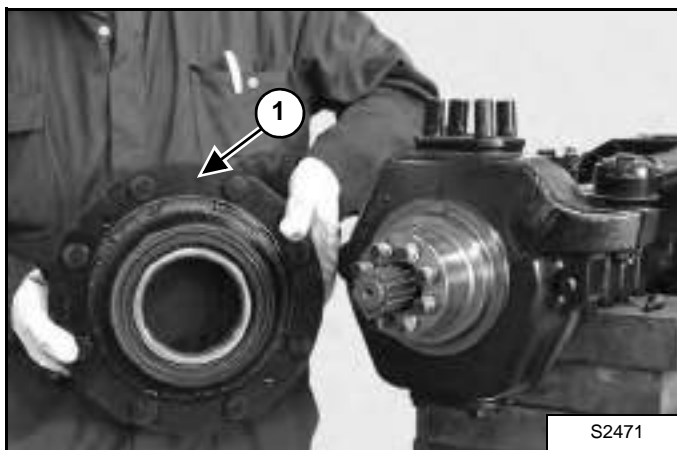

Remove the complete wheel hub (Item 1) [Figure 40-20-10] by hand.

Figure 40-20-11

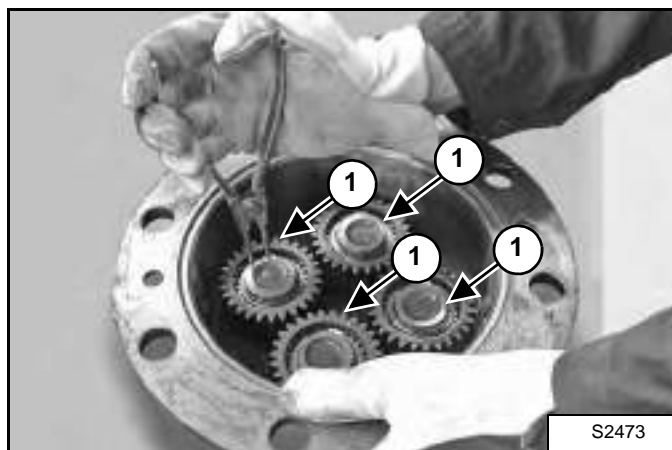

Remove the snap rings (Item 1) [Figure 40-20-11].

Figure 40-20-12

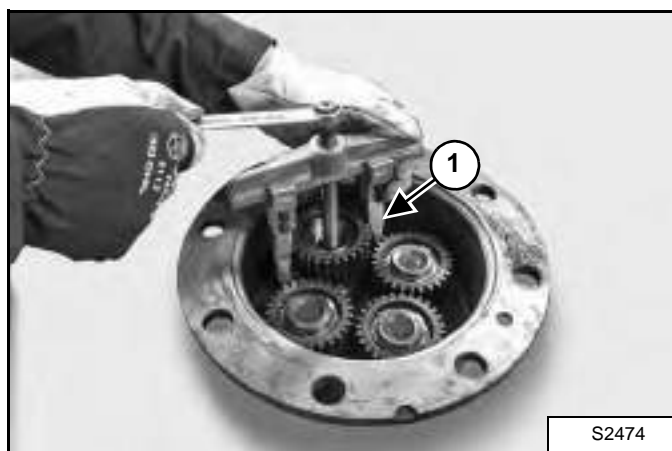

With the help of a puller, remove the planet wheel gears (Item 1) [Figure 40-20-12].

**NOTE:** Mark the assembly side of the planet wheels.

**AXLE AND DIFFERENTIAL (FRONT) (CONT'D)**

**Planetary Carrier Disassembly (Cont'd)**

**Figure 40-20-13**

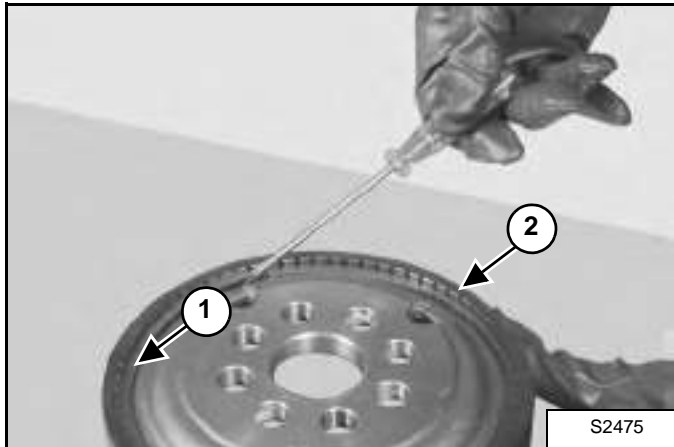

Remove the snap ring (Item 1) from the ring gear (Item 2) [Figure 40-20-13].

**Figure 40-20-14**



Remove the ring gear support (Item 1) [Figure 40-20-14].

**Figure 40-20-15**

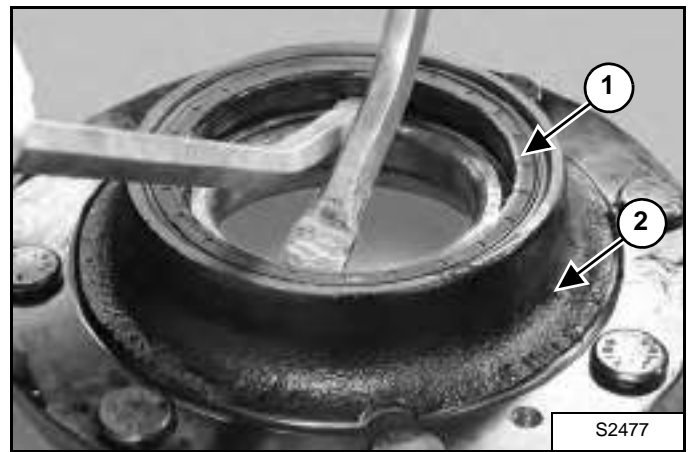

Remove the sealing ring (Item 1) from the wheel hub (Item 2) [Figure 40-20-15].

**Figure 40-20-16**



Remove the internal bearing (Item 1) [Figure 40-20-16].

---

## AXLE AND DIFFERENTIAL (FRONT) (CONT'D)

### Planetary Carrier Disassembly (Cont'd)

Figure 40-20-17



Remove the external bearing races from the bearing forcing a pin-driver into the appropriate slots on the hub (Item 1) [Figure 40-20-17].

**NOTE:** Hammer in an alternate way so as to avoid crawling or deformation of the bearing races.

# Steering Knuckle and Drive Axle Parts Identification

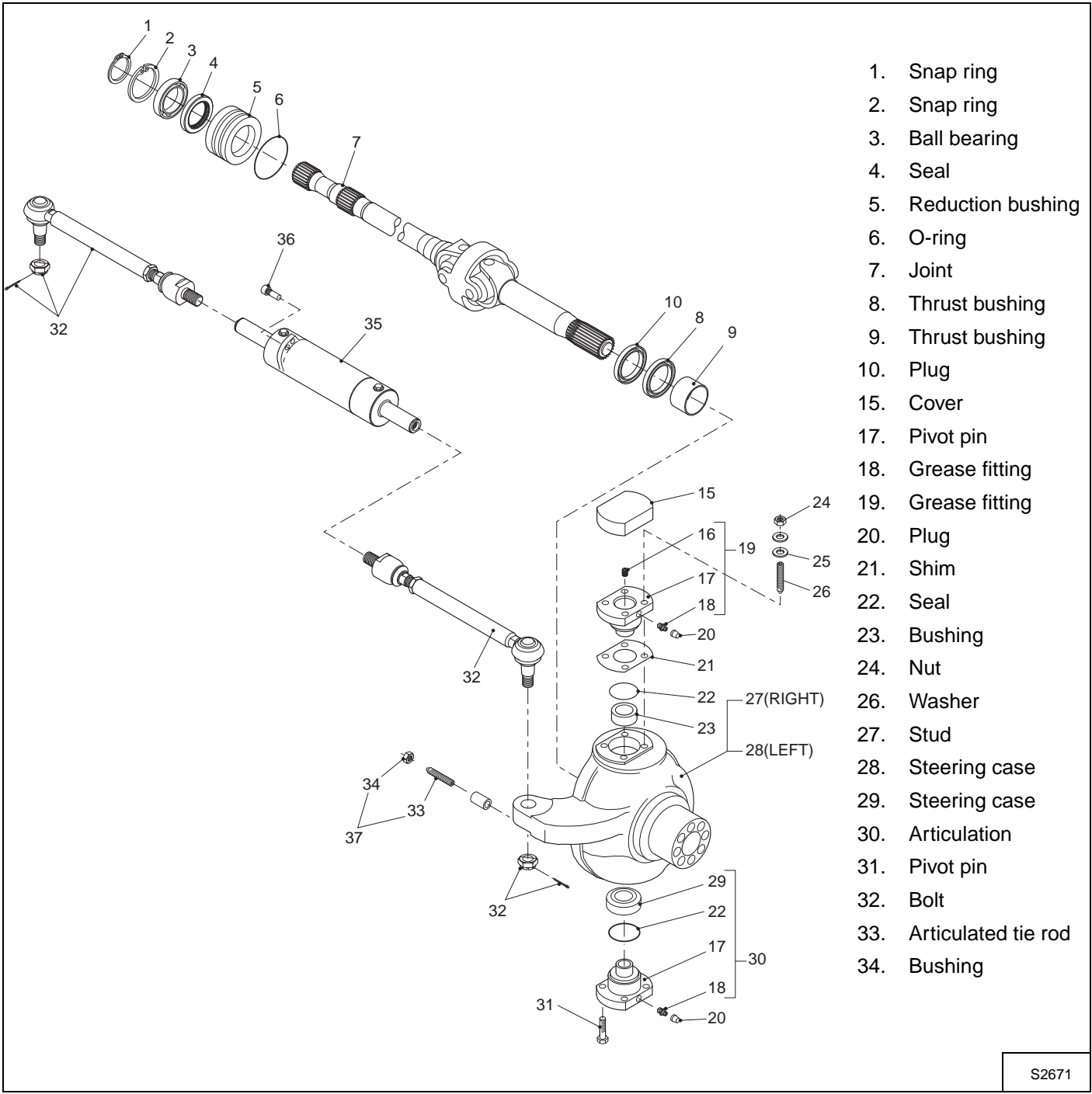

- 1. Snap ring
- 2. Snap ring
- 3. Ball bearing
- 4. Seal
- 5. Reduction bushing
- 6. O-ring
- 7. Joint
- 8. Thrust bushing
- 9. Thrust bushing
- 10. Plug
- 15. Cover
- 17. Pivot pin
- 18. Grease fitting
- 19. Grease fitting
- 20. Plug
- 21. Shim
- 22. Seal
- 23. Bushing
- 24. Nut
- 26. Washer
- 27. Stud
- 27(RIGHT)
- 28(LEFT)
- 28. Steering case
- 29. Steering case
- 30. Articulation
- 31. Pivot pin
- 32. Bolt
- 33. Articulated tie rod
- 34. Bushing

S2671

## AXLE AND DIFFERENTIAL (FRONT) (CONT'D)

### Steering Knuckle Disassembly

Figure 40-20-18

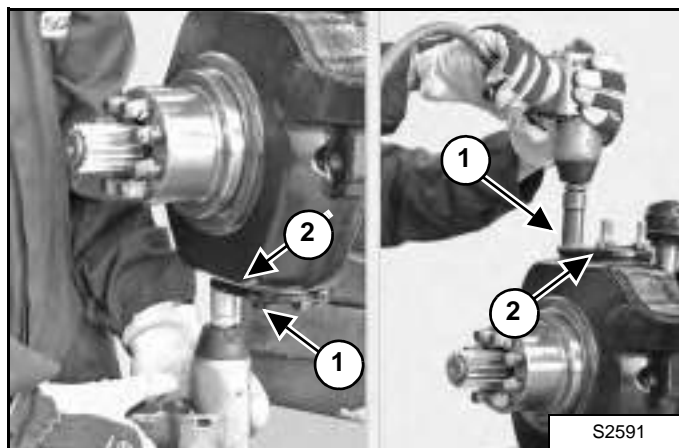

Loosen and remove the fitting screws (Item 1) from the tie rod (Item 2) [Figure 40-20-18].

Figure 40-20-19



Using two levers, remove the bottom tie rod (Item 1) complete with front sealing ring (Item 2) [Figure 40-20-19].

Figure 40-20-20

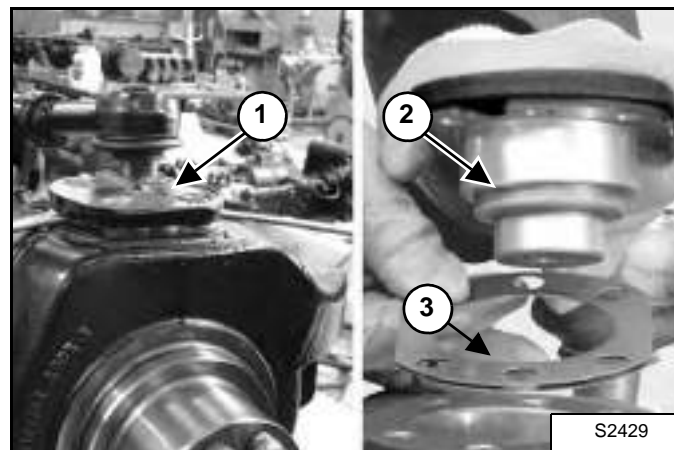

Using two levers, remove the top tie rod (Item 1) complete with front sealing ring (Item 2) and shims (Item 3) [Figure 40-20-20].

Figure 40-20-21

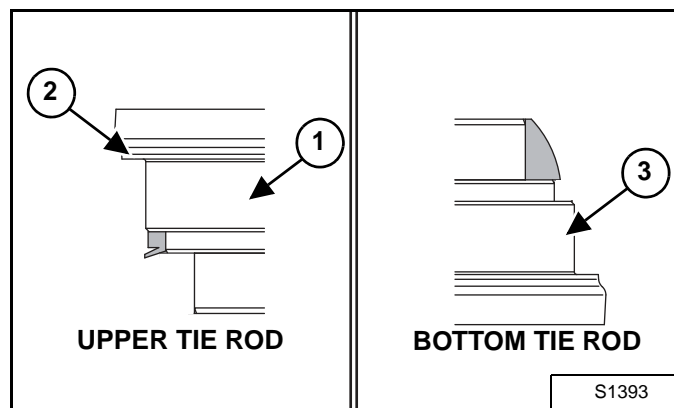

Configuration of the upper (Item 1) tie rod with shims (Item 2) and the bottom tie rod (Item 3) [Figure 40-20-21].



## AXLE AND DIFFERENTIAL (FRONT) (CONT'D)

### Steering Knuckle Disassembly (Cont'd)

Figure 40-20-22

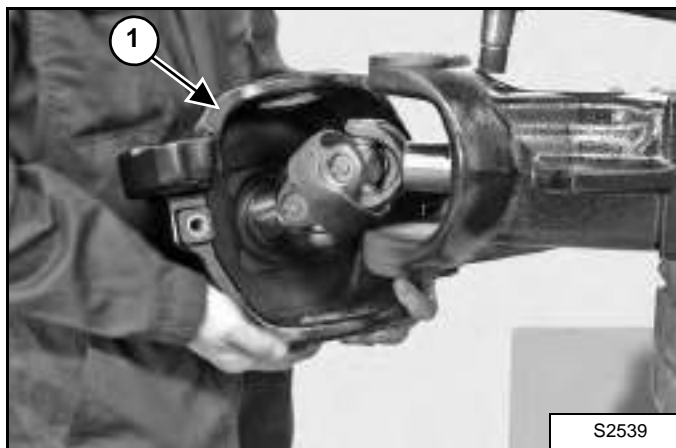

Remove the complete steering case (Item 1) [Figure 40-20-22].

Figure 40-20-23

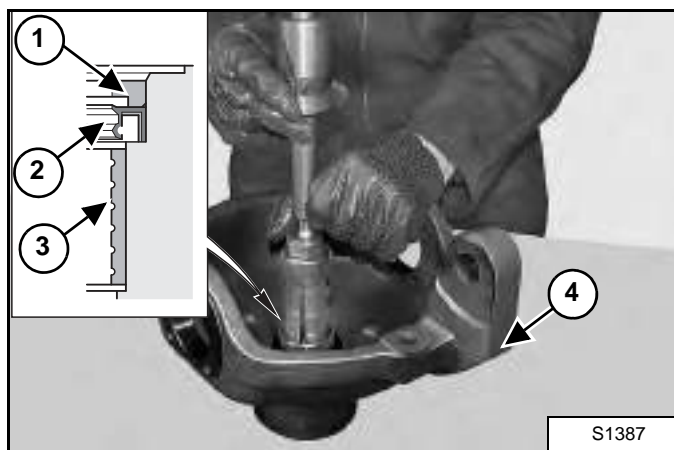

Use a puller to remove the centering ring (Item 1), the sealing ring (Item 2) and the bearing (Item 3) from the steering case (Item 4) [Figure 40-20-23].

**NOTE:** Note down the orientation of both centering and sealing ring.

## AXLE AND DIFFERENTIAL (FRONT) (CONT'D)

### Drive Axle Disassembly

Figure 40-20-24

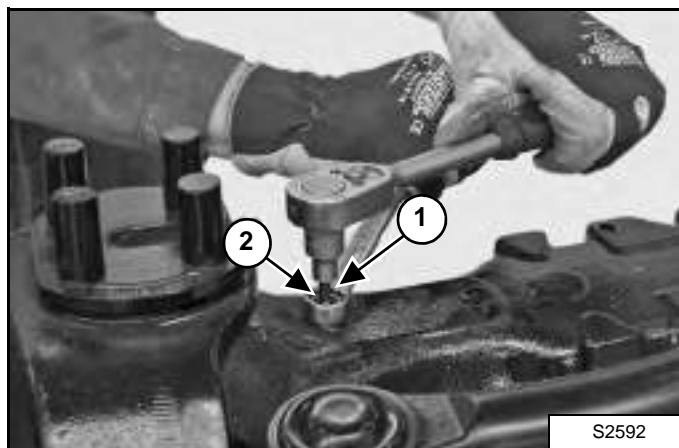

Loosen and remove the top and bottom check nuts (Item 1) from the dowels (Item 2) [Figure 40-20-24].

Figure 40-20-25

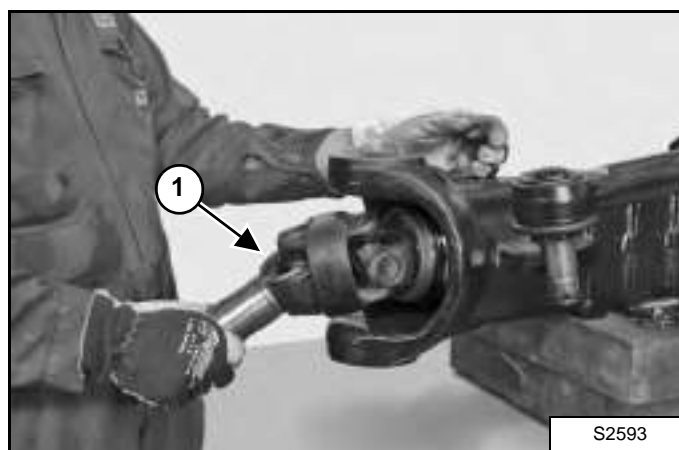

Remove the entire drive axle (Item 1) [Figure 40-20-25].

**NOTE:** To remove the drive axle use, if necessary, a plastic hammer or a lever.

Figure 40-20-26

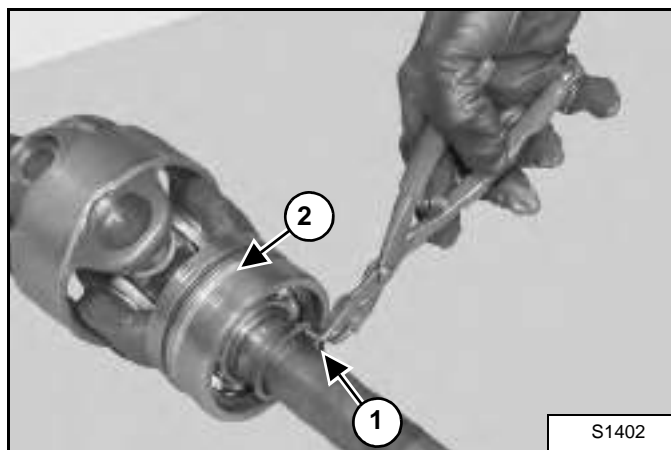

Remove the snap ring (Item 1) from the bushing unit (Item 2) [Figure 40-20-26].

Figure 40-20-27

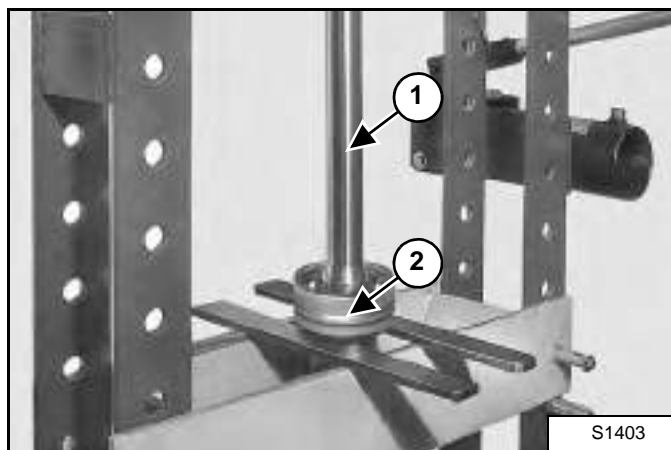

Position the entire drive axle (Item 1) under a press and remove the complete bush (Item 2) [Figure 40-20-27].

## AXLE AND DIFFERENTIAL (FRONT) (CONT'D)

### Drive Axle Disassembly (Cont'd)

Figure 40-20-28

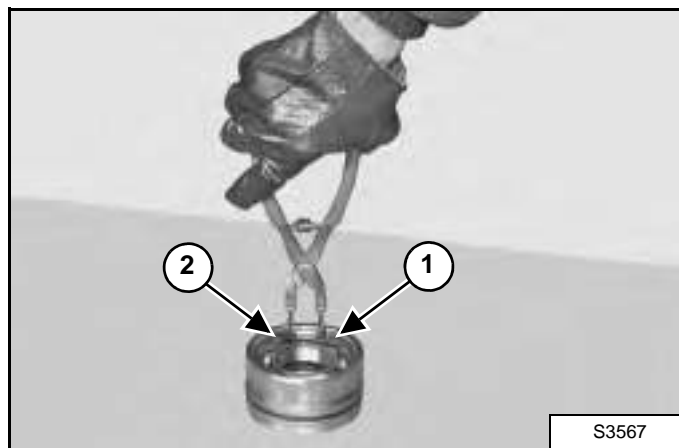

Remove the snap ring (Item 1) from the bearing (Item 2) [Figure 40-20-28].

Figure 40-20-29

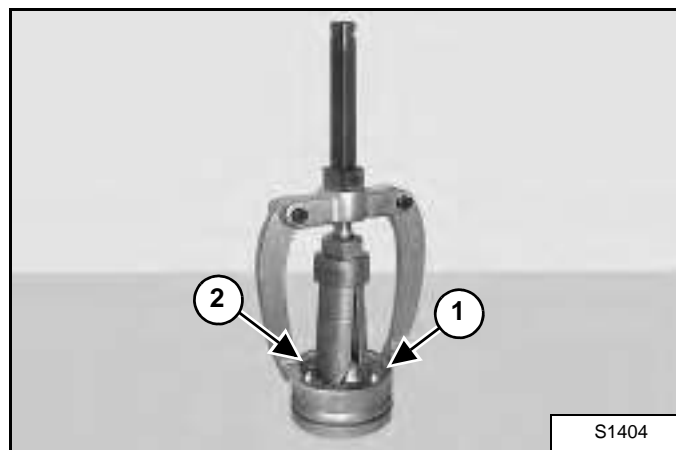

Use a puller to remove the bearing (Item 1), the sealing ring (Item 2) [Figure 40-20-29] and the O-ring.

# AXLE AND DIFFERENTIAL (FRONT) (CONT'D)

## Brake system Identification

Figure 40-20-30

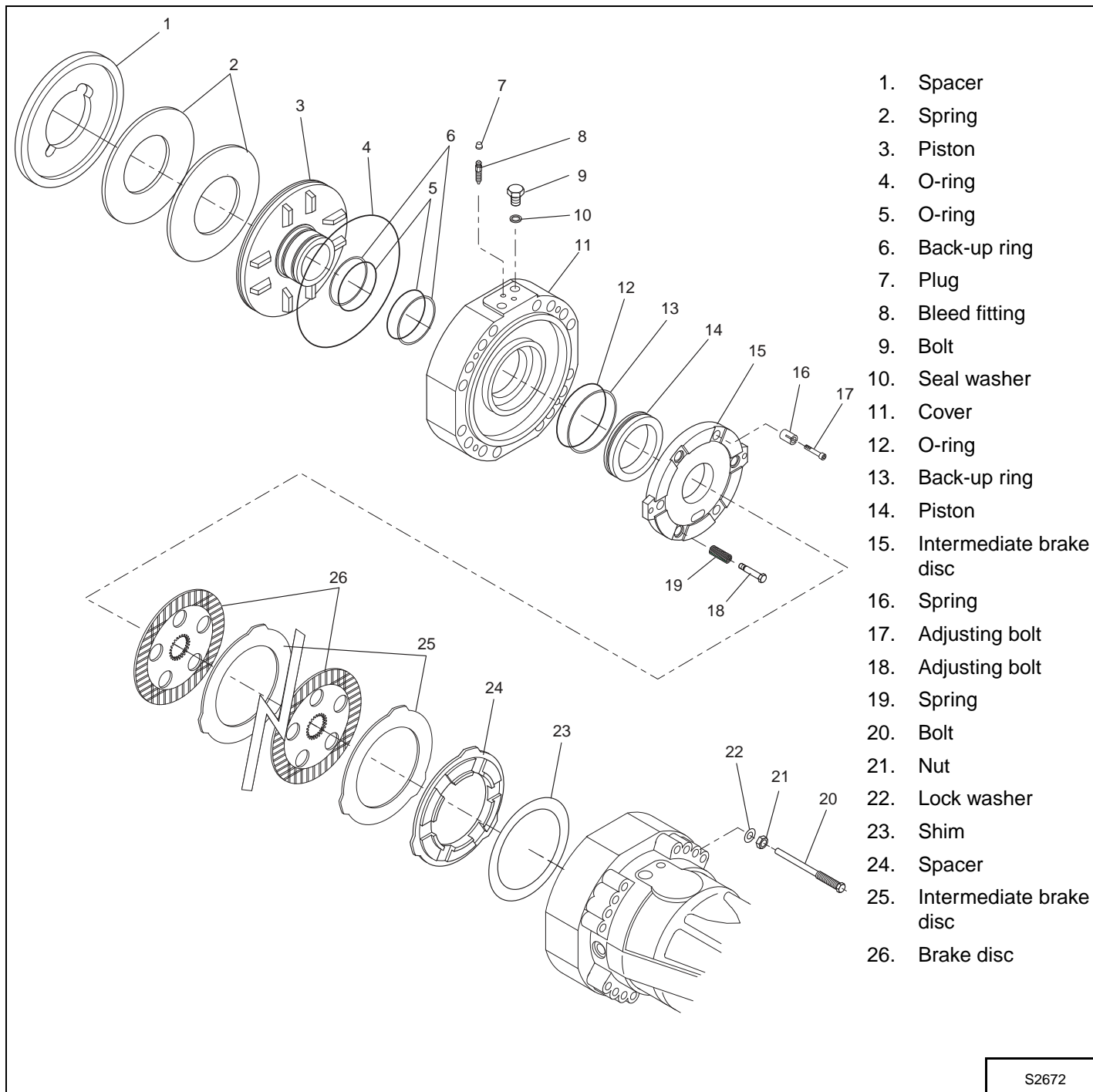

S2672

## AXLE AND DIFFERENTIAL (FRONT) (CONT'D)

### Brake System Disassembly

Figure 40-20-31

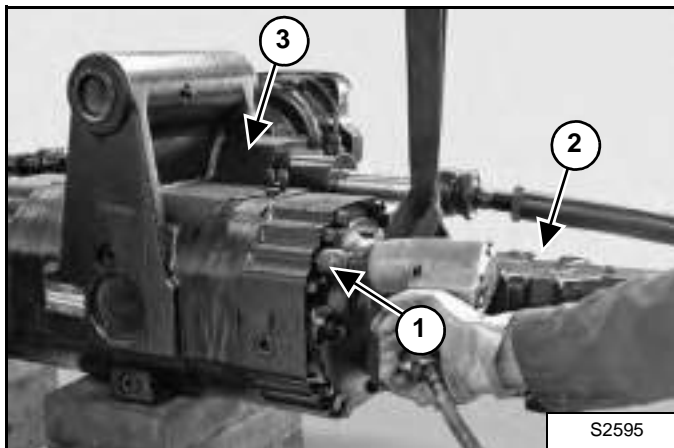

Sling the arms to be removed and connect it to a hoist. Loosen and remove the screws (Item 1) that fix the arm (Item 2) to the central body (Item 3) [Figure 40-20-31].

Figure 40-20-32

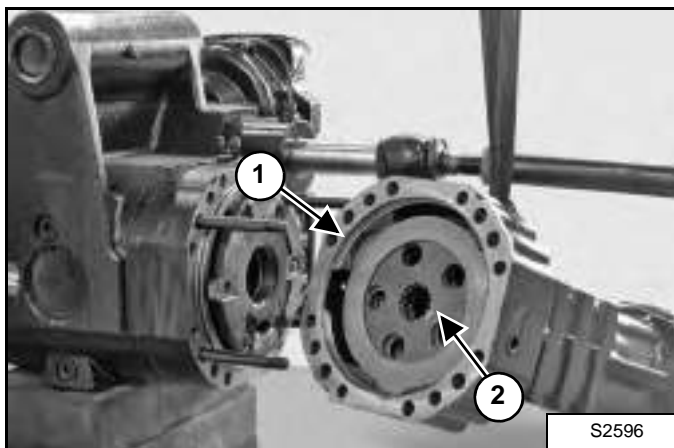

Remove arm (Item 1) together with the pack of the braking discs (Item 2) [Figure 40-20-32]. Place the arm on a bench.

Figure 40-20-33

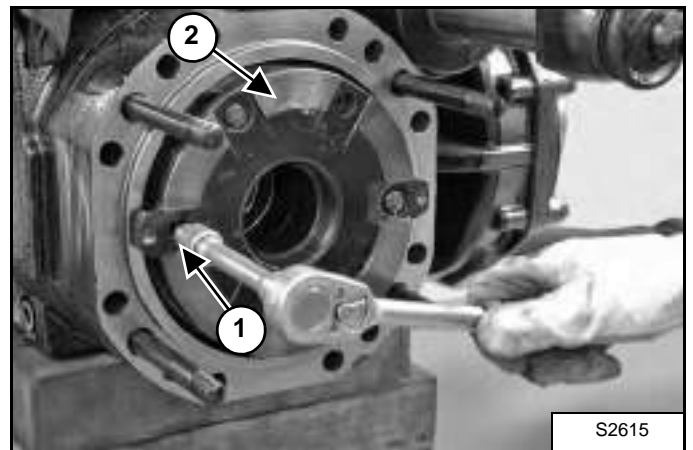

Remove the adjusting bolts (Item 1) from the intermediate brake disc (Item 2) [Figure 40-20-33].

## AXLE AND DIFFERENTIAL (FRONT) (CONT'D)

### Brake System Disassembly (Cont'd)

Figure 40-20-34

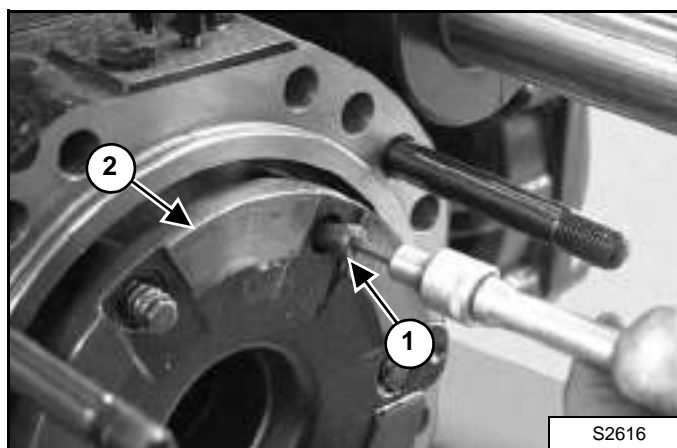

Remove the pin screws (Item 1) guiding the intermediate brake disc (Item 2) [Figure 40-20-34].

## IMPORTANT

If the screws are to be replaced, note down the different colours for the different brake gaps.

Figure 40-20-35

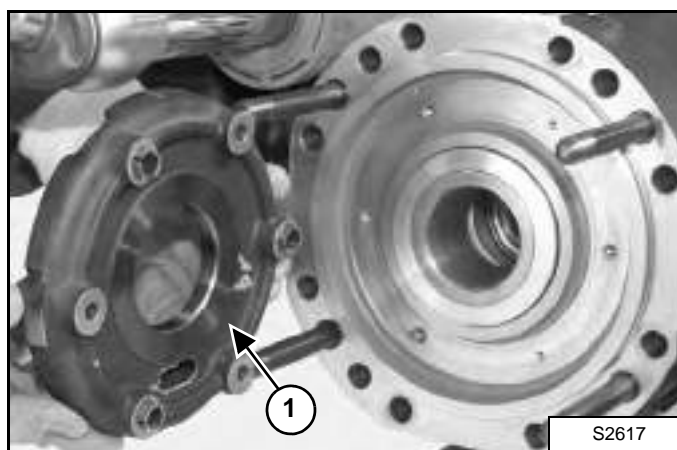

Remove the intermediate brake disc (Item 1) [Figure 40-20-35].

Figure 40-20-36

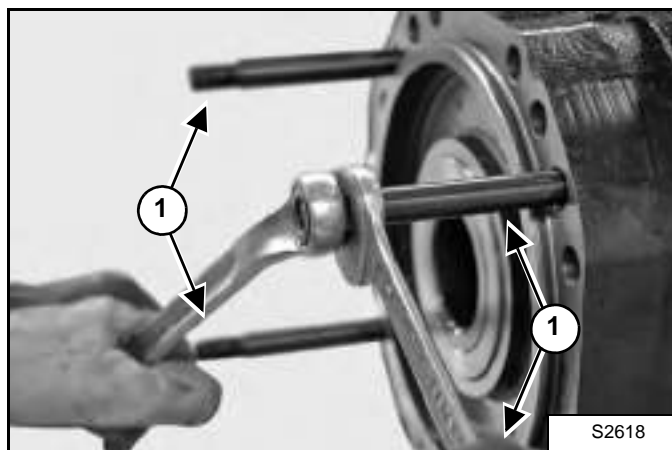

Loose the four studs (Item 1) [Figure 40-20-36].

Figure 40-20-37

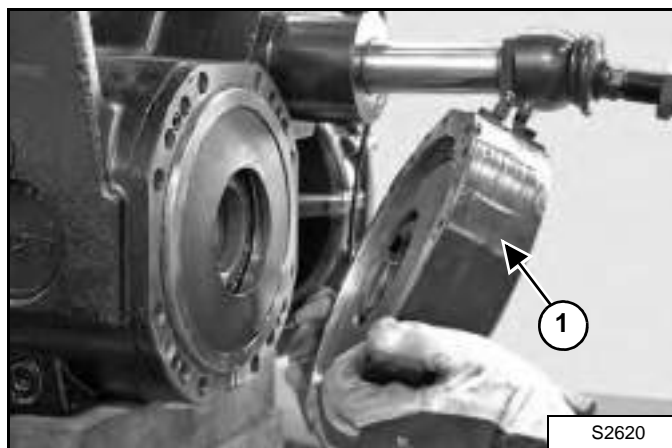

Remove the cover (Item 1) [Figure 40-20-37].

## AXLE AND DIFFERENTIAL (FRONT) (CONT'D)

### Brake System Disassembly (Cont'd)

Figure 40-20-38

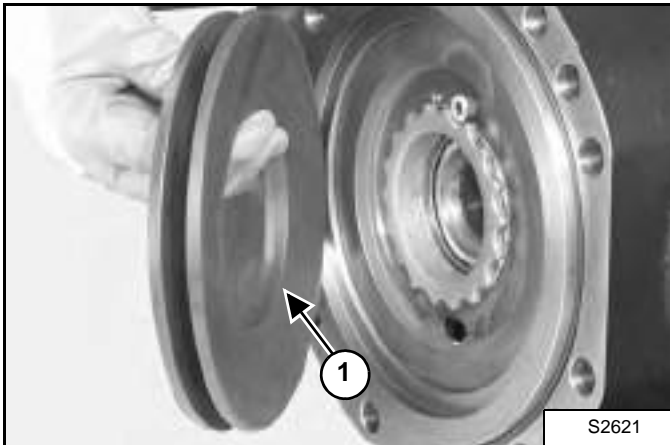

Remove the Belleville washers (Item 1) [Figure 40-20-38] and note down direction of assembly.

Figure 40-20-39

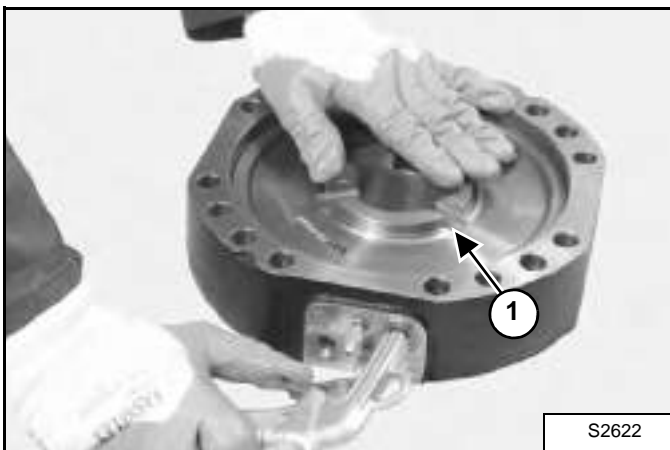

Slowly introduce low-pressure compressed air through the connection member for the service brake, in order to extract the piston (Item 1) [Figure 40-20-39].

## IMPORTANT

Hold the piston back, as it may be suddenly ejected and damaged.

Figure 40-20-40



Note down their order of assembly and remove negative piston. Sign the position [Figure 40-20-40].

Figure 40-20-41

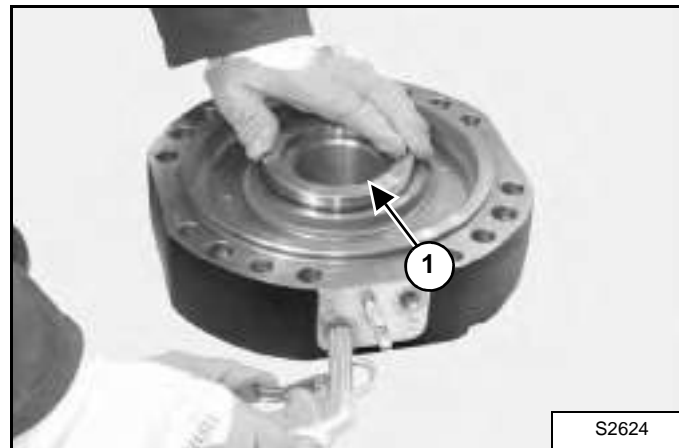

Slowly introduce low-pressure compressed air through the connection member for the service brake, in order to extract the piston (Item 1) [Figure 40-20-41].

## IMPORTANT

Hold the piston back, because it may be suddenly ejected.

## AXLE AND DIFFERENTIAL (FRONT) (CONT'D)

### Brake System Disassembly (Cont'd)

Figure 40-20-42

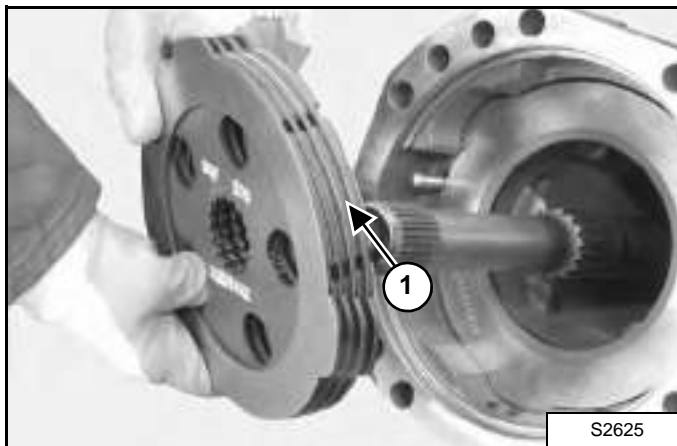

Remove the braking discs (Item 1) [Figure 40-20-42], noting down direction of assembly.

**NOTE:** If disks are not to be replaced, avoid changing their position

Figure 40-20-43

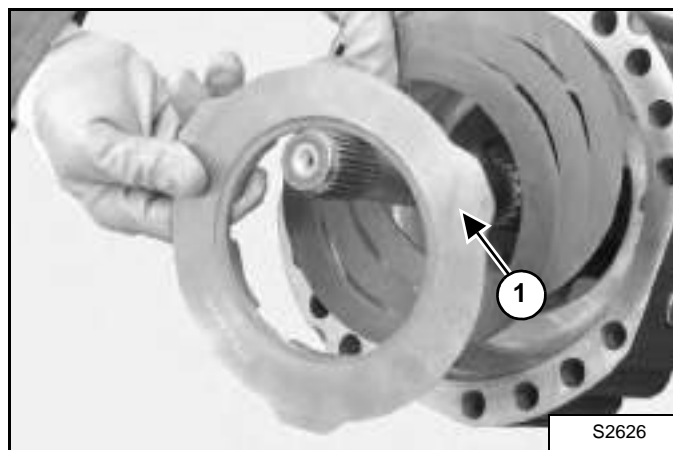

Remove the braking discs, noting down direction of assembly (Item 1) [Figure 40-20-43].

**NOTE:** If disks are not to be replaced, avoid changing their position.



## AXLE AND DIFFERENTIAL (FRONT) (CONT'D)

### Differential Parts Identification

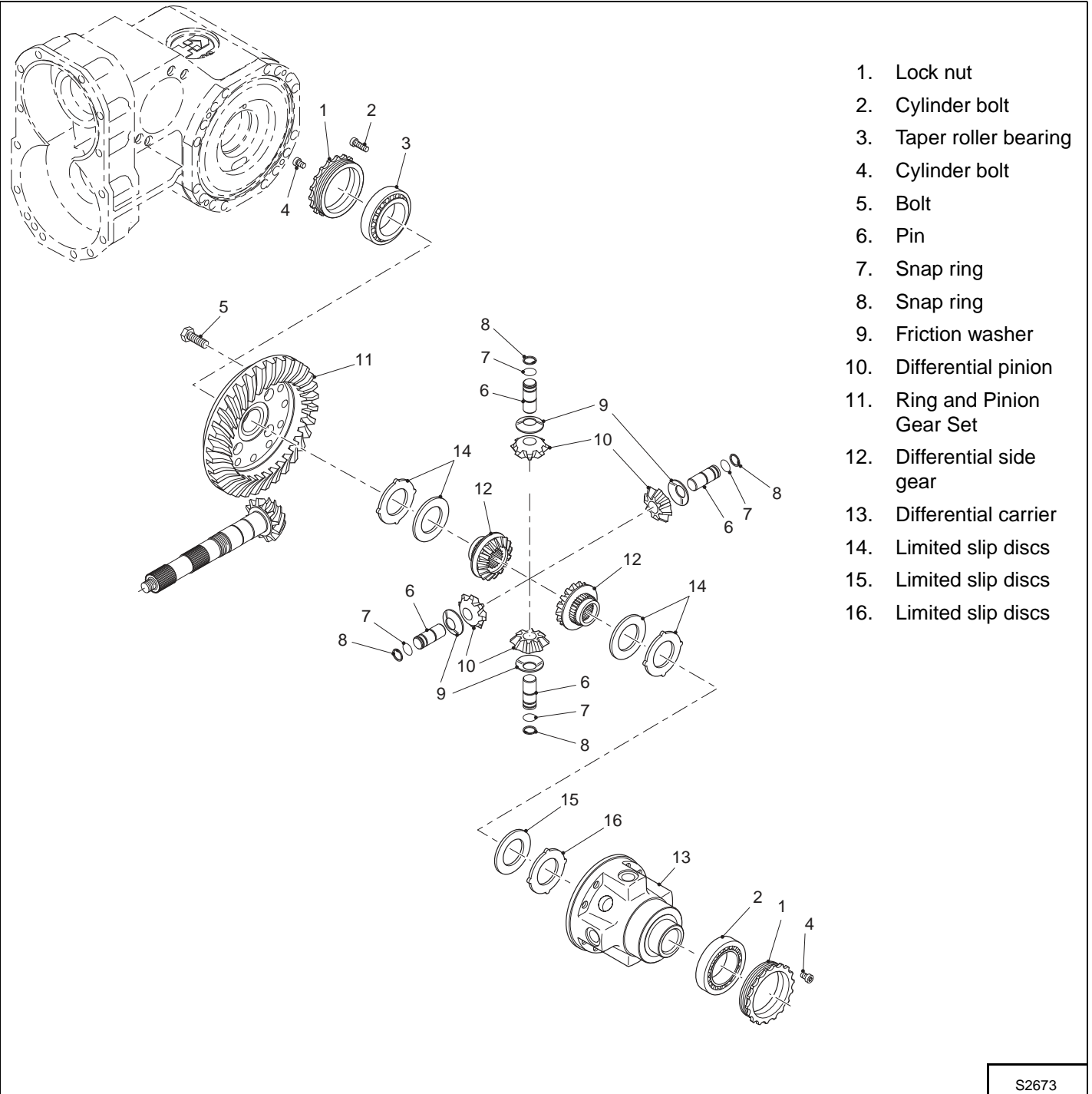

S2673

## AXLE AND DIFFERENTIAL (FRONT) (CONT'D)

### Differential Disassembly

Figure 40-20-44

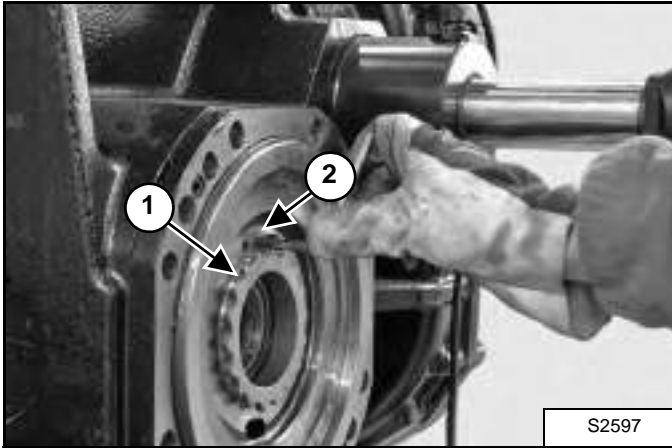

Mark the position of the ring nut (Item 1). Remove the cylinder bolts (Item 2) [Figure 40-20-44] from the ring nut.

Figure 40-20-45

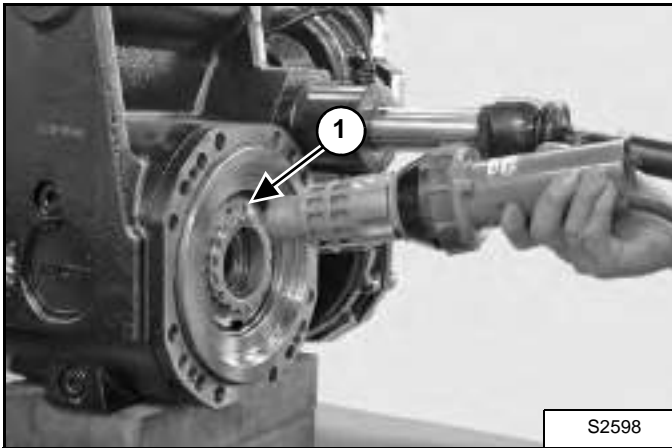

Uniformly heat the ring nuts (Item 1) [Figure 40-20-45] up to a temperature of 80°C.

**! WARNING**

**AVOID BURN INJURY**

**Wear protective clothing when handling hot parts.**

Figure 40-20-46

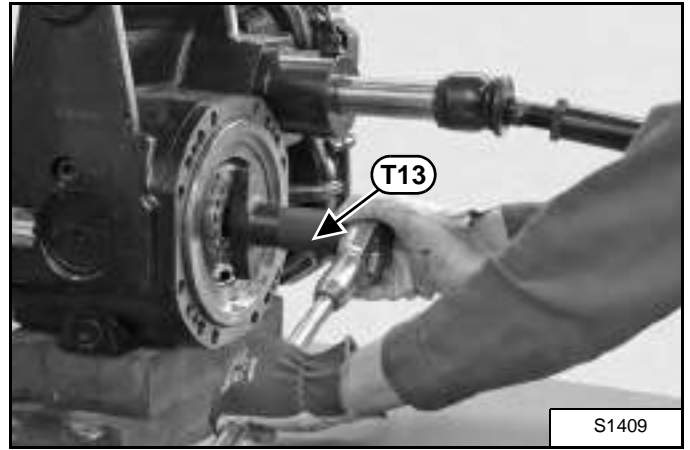

Apply tool **T13** and remove the ring nuts.

Figure 40-20-47

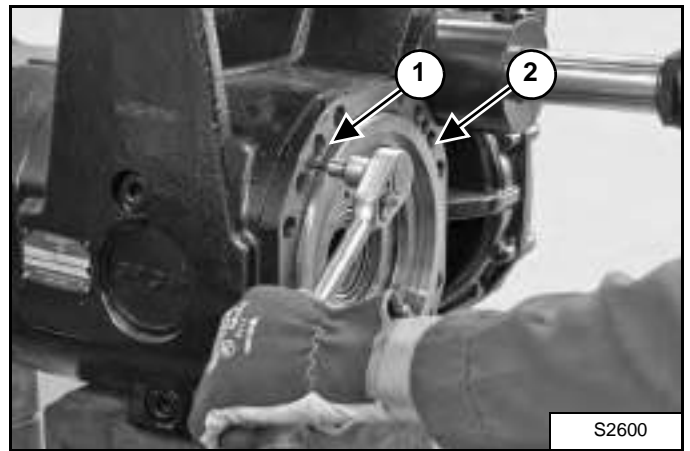

Remove the fitting screws (Item 1) from the middle cover (Item 2) [Figure 40-20-47].

## AXLE AND DIFFERENTIAL (FRONT) (CONT'D)

### Differential Disassembly (Cont'd)

Figure 40-20-48

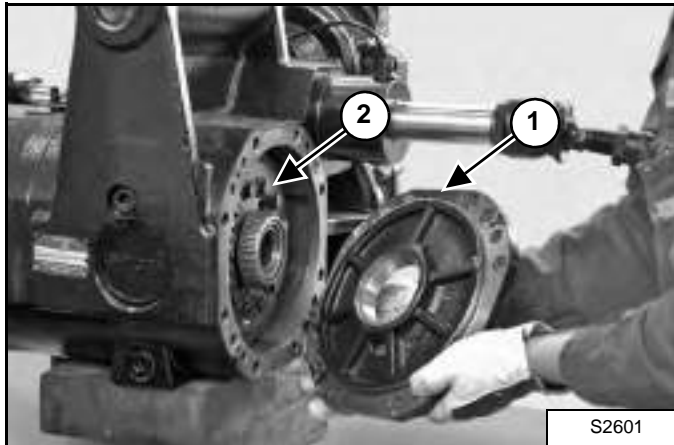

Insert a screwdriver in the opposing slots then force and remove the middle cover (Item 1) and the complete differential unit (Item 2) [Figure 40-20-48].

Figure 40-20-49

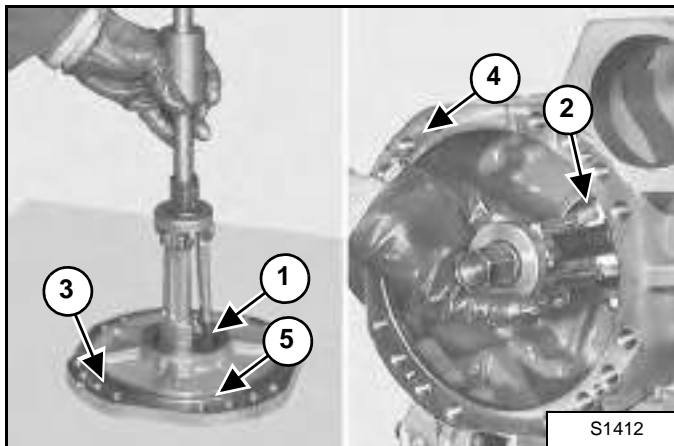

If the bearings need replacing, extract the bearing race (Item 1 and 2) from the middle cover (Item 3) and central body (Item 4) [Figure 40-20-49].

**NOTE:** Check for damaged O-rings (Item 5) [Figure 40-20-49].

Figure 40-20-50

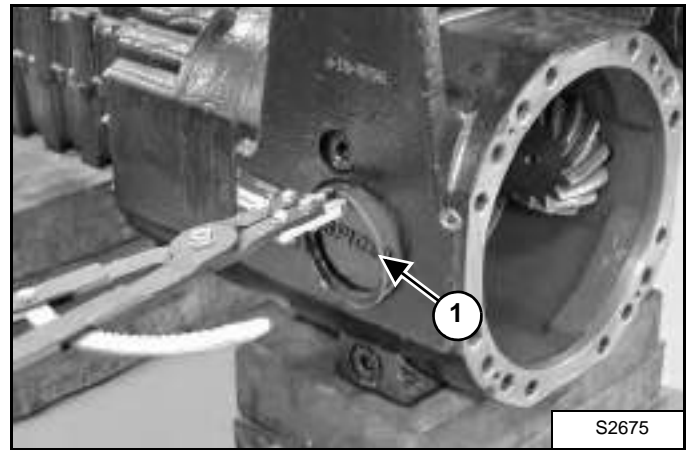

Remove the snap ring (Item 1) [Figure 40-20-50].

Figure 40-20-51

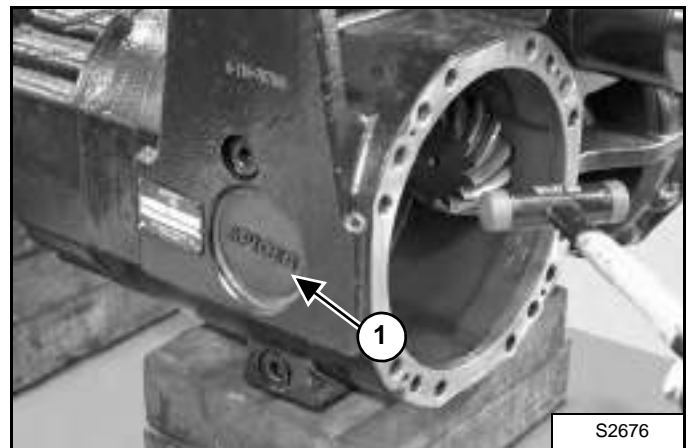

Remove the plug (Item 1) [Figure 40-20-51].

## AXLE AND DIFFERENTIAL (FRONT) (CONT'D)

### Differential Disassembly (Cont'd)

Figure 40-20-52

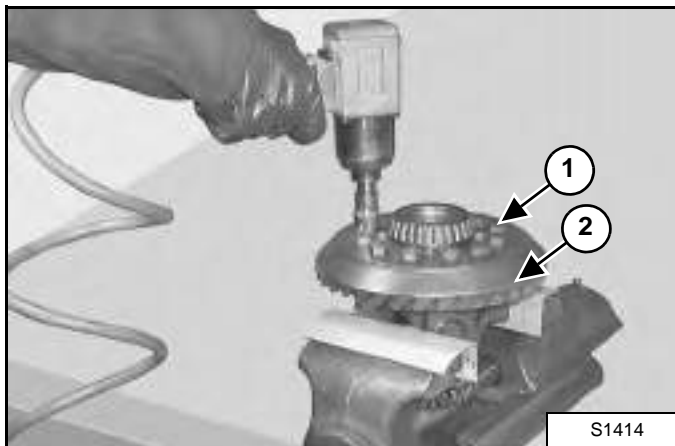

Remove the fitting screws (Item 1) from the crown (Item 2) [Figure 40-20-52].

Figure 40-20-53

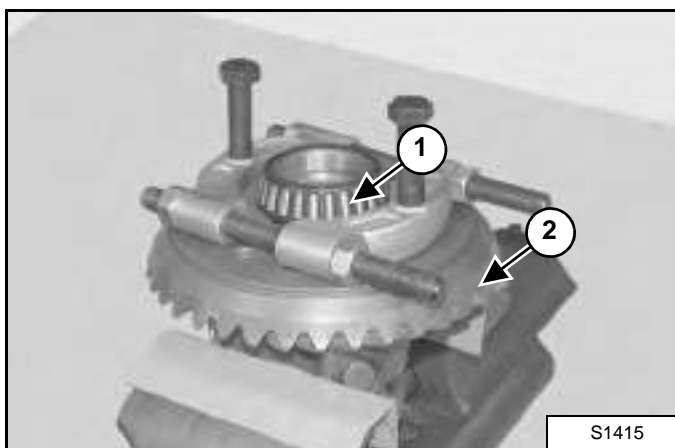

If the bearing needs to be replaced, extract the bearing (Item 1) and remove the crown (Item 2) [Figure 40-20-53].

Figure 40-20-54

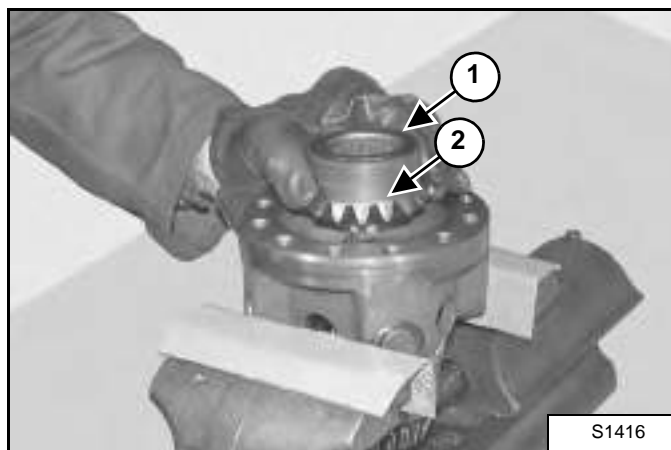

Remove the shim washer (Item 1) and the planetary gear (Item 2) [Figure 40-20-54].

Figure 40-20-55

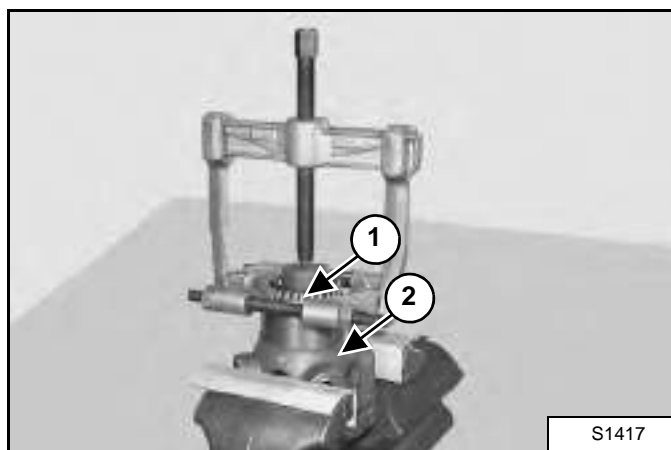

If the bearing needs to be replaced, extract the bearing (Item 1) from the differential carrier (Item 2) [Figure 40-20-55].

## AXLE AND DIFFERENTIAL (FRONT) (CONT'D)

### Differential Disassembly (Cont'd)

Figure 40-20-56

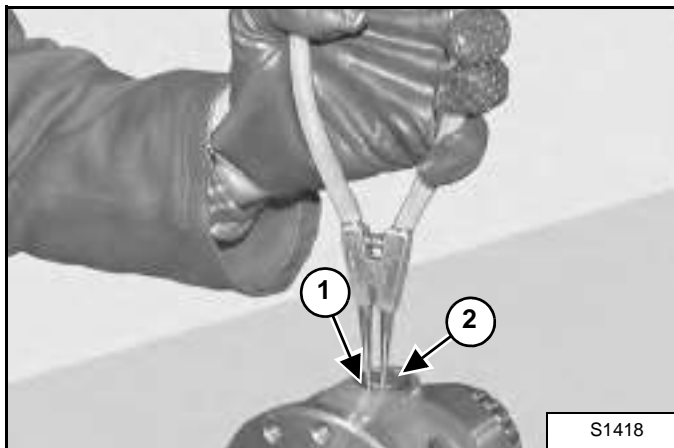

Remove the snap rings (Item 1) from the four pins (Item 2) [Figure 40-20-56] of the planet wheel gears.

Figure 40-20-57

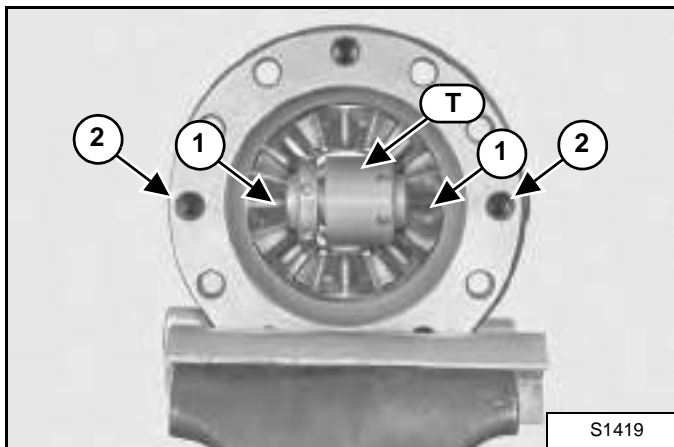

Insert a tool T between two planet wheel gears (Item 1) [Figure 40-20-57].

**NOTE:** Make sure that the tool is perfectly lined up with the pins (Item 2) [Figure 40-20-57] when locked.

Figure 40-20-58

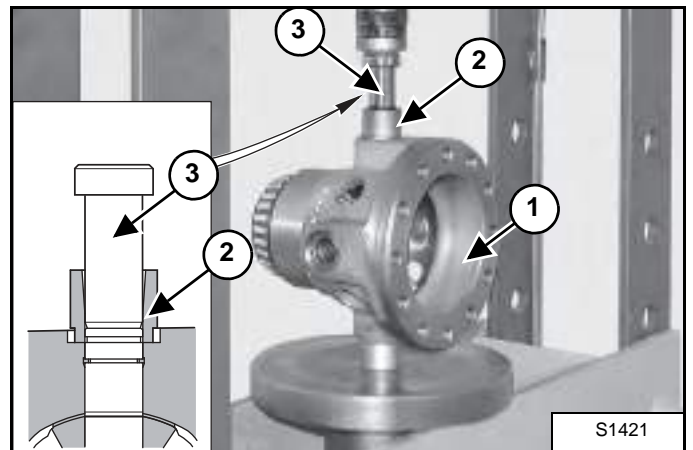

Place the differential carrier (Item 1) under a press, position a bushing (Item 2) and insert a pin (Item 3) [Figure 40-20-58]. Press the pin of the upper planet wheel gear into the tool T [Figure 40-20-57].

Figure 40-20-59



Remove pinion and bush [Figure 40-20-59].

**NOTE:** In this condition the tool contains the pin.

## AXLE AND DIFFERENTIAL (FRONT) (CONT'D)

### Differential Disassembly (Cont'd)

Figure 40-20-60



Remove the tool with inside the pin of the planet wheel gear [Figure 40-20-60].

Figure 40-20-61

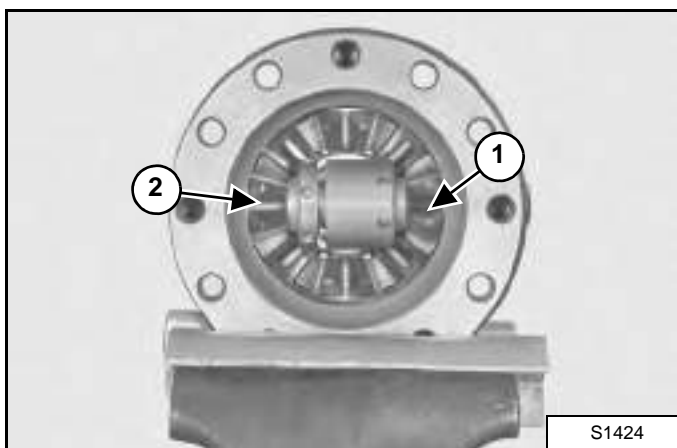

Leave the released planet wheel gear (Item 1) in position and again lock the tool.

Repeat the operations for the extraction of the pin of the 2nd planet wheel gear (Item 2) [Figure 40-20-61].

Repeat the operations for the two remaining pins.

Figure 40-20-62

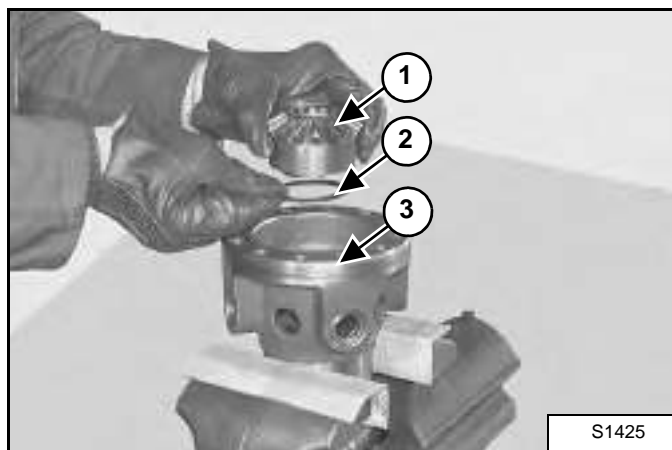

Remove the tool T and remove the planet wheel gears (Item 1) and the relative shim washers (Item 2) from the differential carrier (Item 3) [Figure 40-20-62].

## AXLE AND DIFFERENTIAL (FRONT) (CONT'D)

### Bevel pinion Parts Identification

1. Cover
2. Gear
3. Snap ring
4. Ball bearing
5. Snap ring
6. Ring and Pinion Gear Set
7. Taper roller bearing
8. Shim
9. Shim
10. Spacer
11. Lock nut
12. Seal
13. Ball bearing
14. Gear
15. Snap ring
16. Ball bearing
17. Seal
18. Plug
19. Spring washer
20. Hexagon bolt
21. Magnet plug
22. Dowel
23. Plug
24. Flange
25. O-ring
26. Cylinder bolt

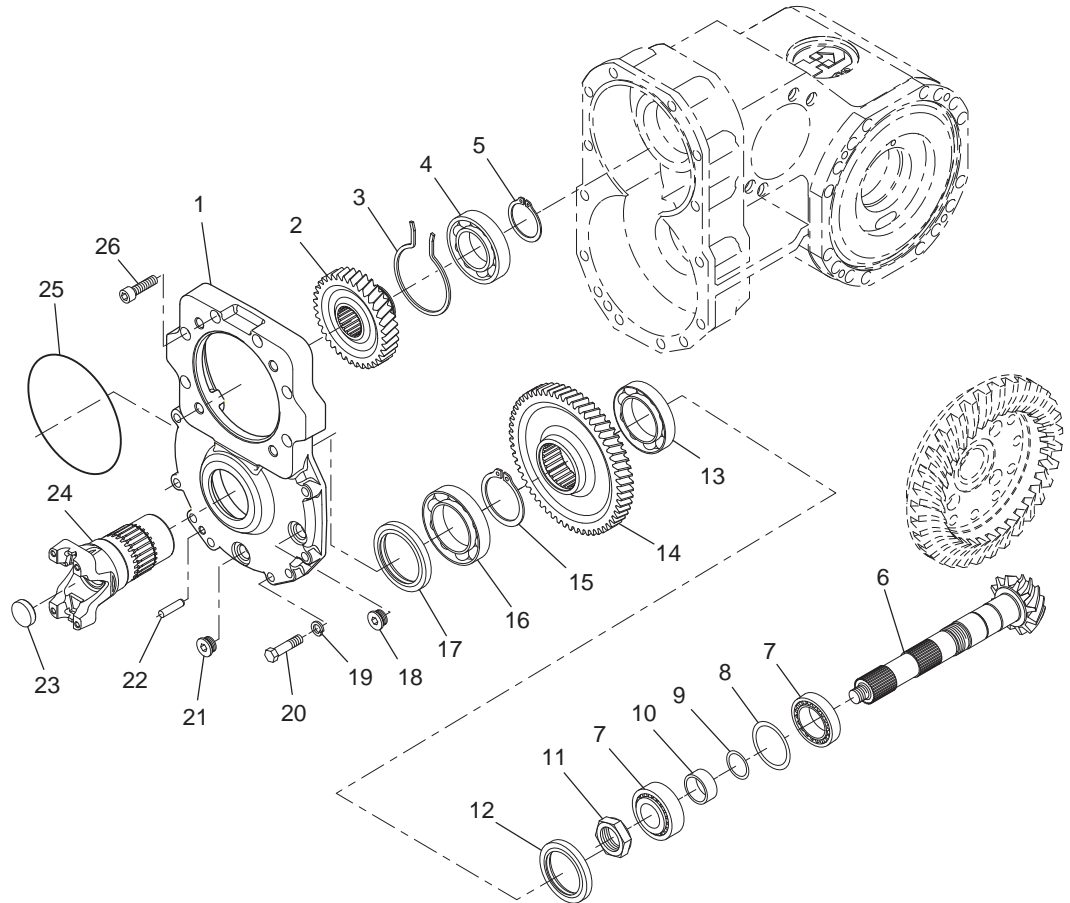

S1568

## AXLE AND DIFFERENTIAL (FRONT) (CONT'D)

### Bevel Pinion Disassembly

Figure 40-20-63

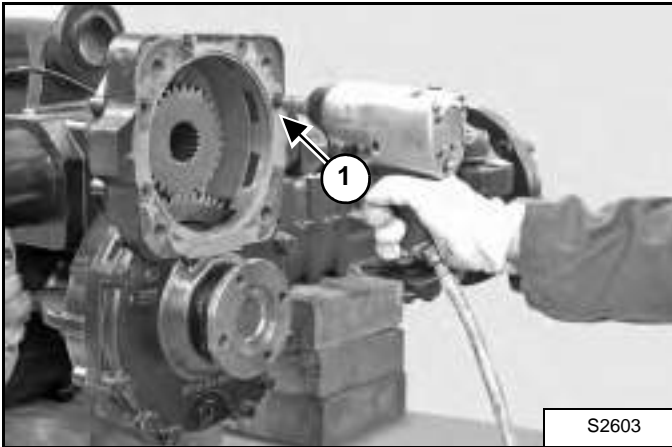

Remove cylinder bolts (Item 1) [Figure 40-20-63] of the drive side flange cover.

Figure 40-20-64

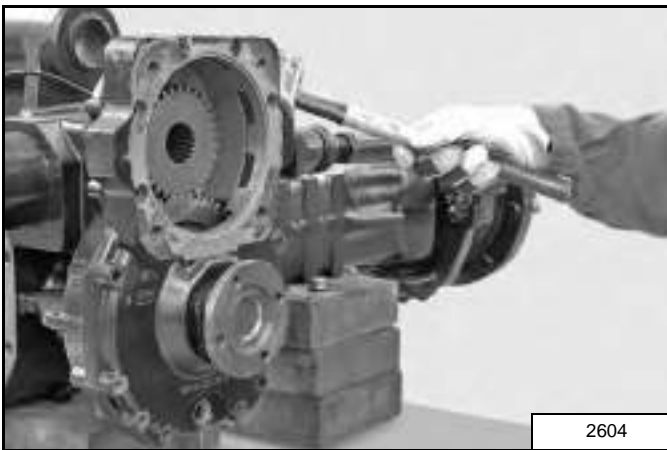

Make the drive side flange cover loose using a plastic hammer [Figure 40-20-64].

Figure 40-20-65

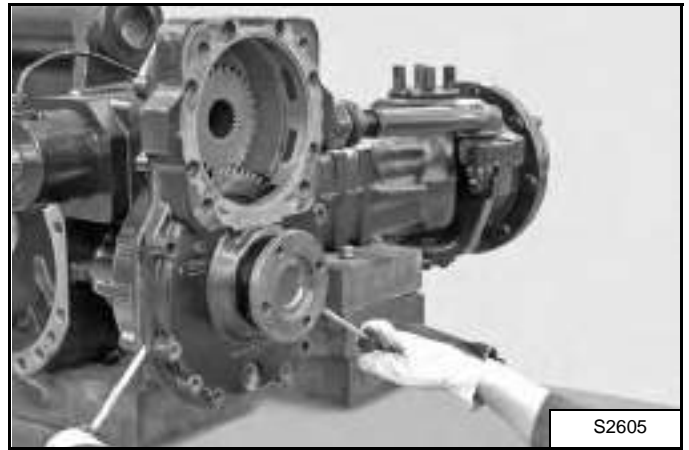

Place two levers into the appropriate slots [Figure 40-20-65].

**NOTE:** Look out not to damage the surfaces.

Figure 40-20-66

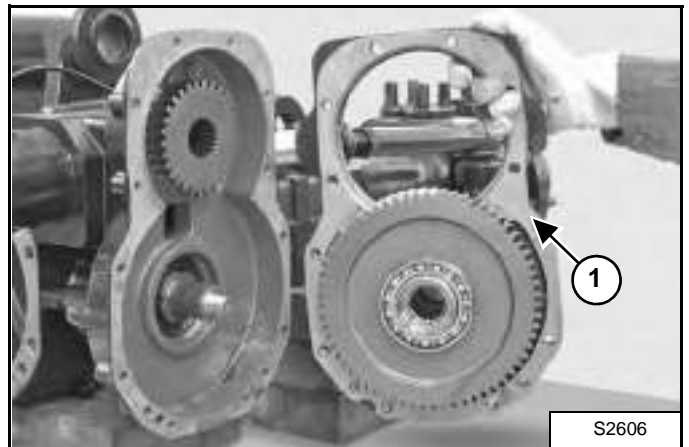

Lift off the cover (Item 1) [Figure 40-20-66].



## AXLE AND DIFFERENTIAL (FRONT) (CONT'D)

### Bevel Pinion Disassembly (Cont'd)

Figure 40-20-67

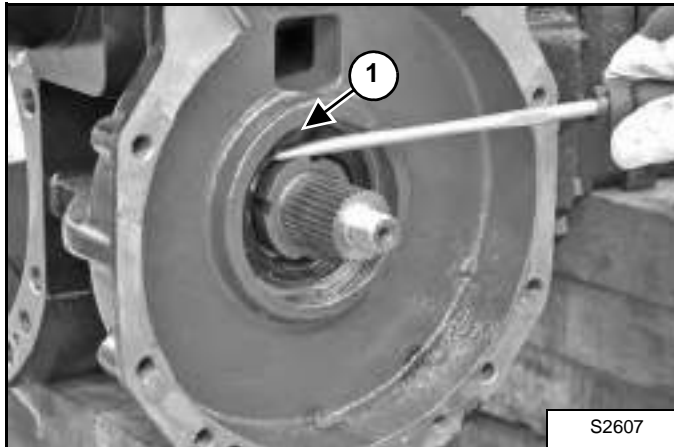

Remove the sealing ring (Item 1) [Figure 40-20-67].

Figure 40-20-68

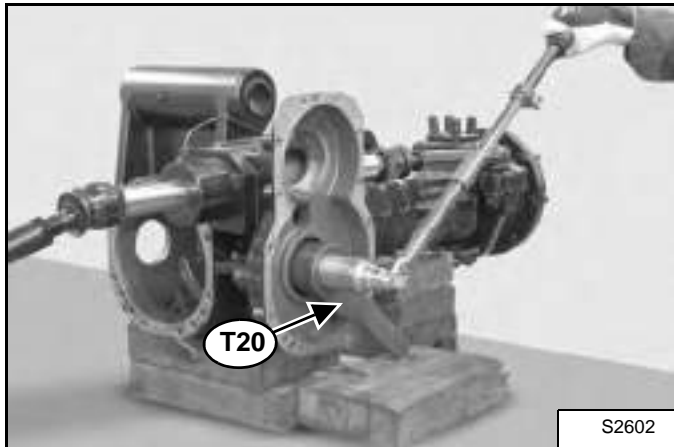

Position tool **T20A** (or T20B), so as to avoid pinion rotation. Unloose and remove the nut; also remove the O-ring.

Figure 40-20-69

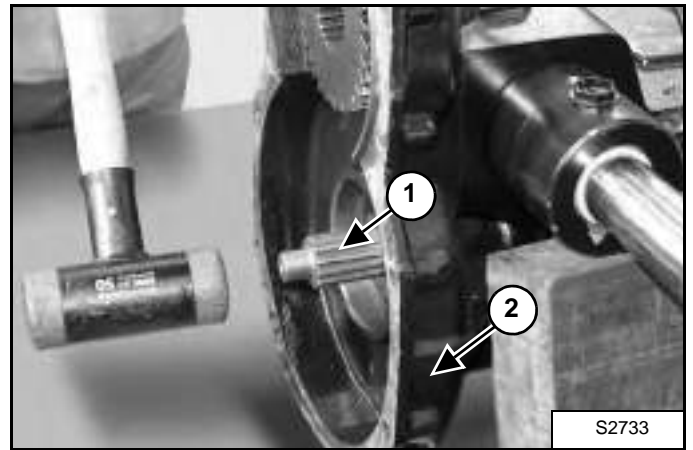

Extract the pinion (Item 1) [Figure 40-20-69] complete with the internal bearing, the distance piece and shims.

**NOTE:** The bearing races of the bearings remain in the central body (Item 2) [Figure 40-20-69].

Figure 40-20-70

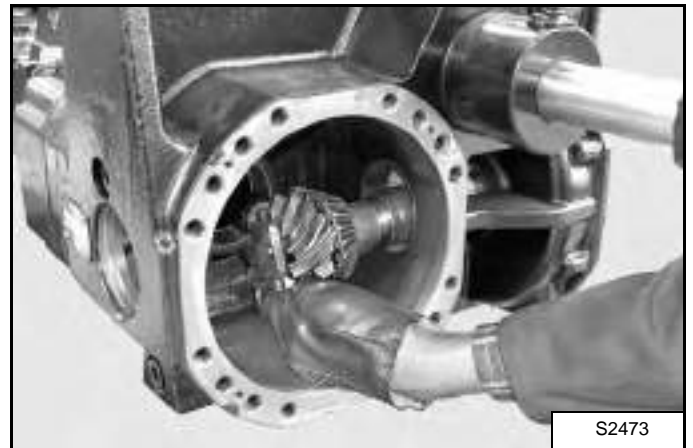

Remove the pinion (Item 1) [Figure 40-20-70], shims and distance piece.

## AXLE AND DIFFERENTIAL (FRONT) (CONT'D)

### Bevel Pinion Disassembly (Cont'd)

Figure 40-20-71

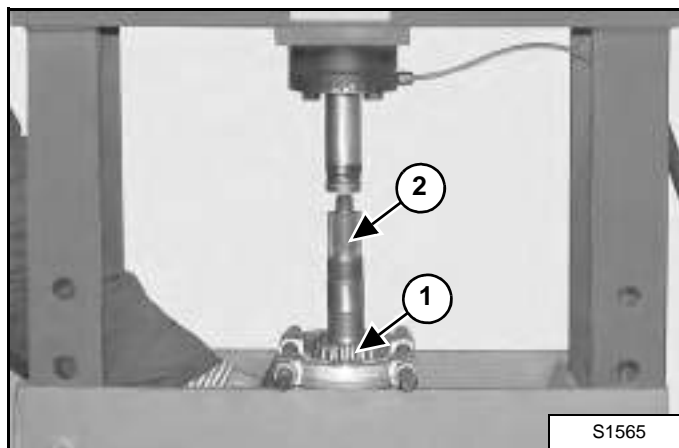

Using a puller and a press, remove the inner bearing (Item 1) from the pinion (Item 2) [Figure 40-20-71].

Figure 40-20-72

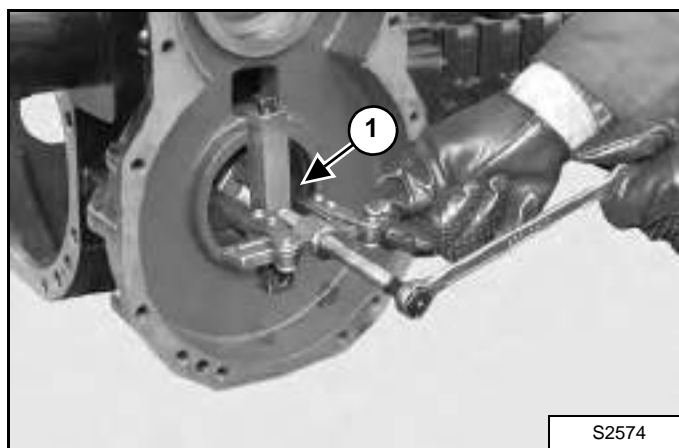

Remove the bearing race (Item 1) [Figure 40-20-72].

Figure 40-20-73

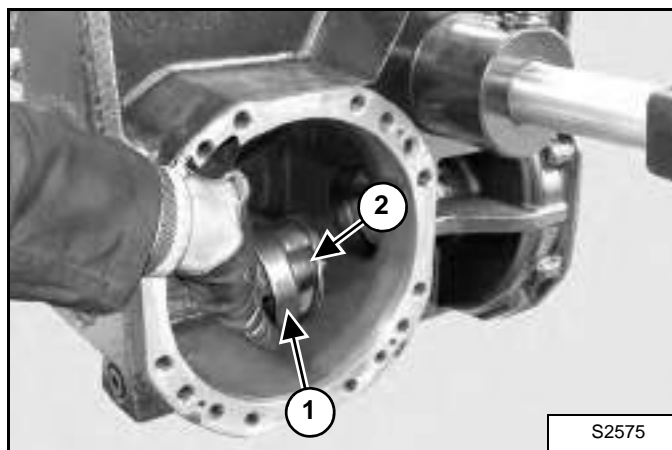

Insert a drift in the appropriate holes and remove the bearing race (Item 1) as well as the shim washers (Item 2) [Figure 40-20-73].

## AXLE AND DIFFERENTIAL (FRONT) (CONT'D)

### Bevel Pinion Assembly

Figure 40-20-74

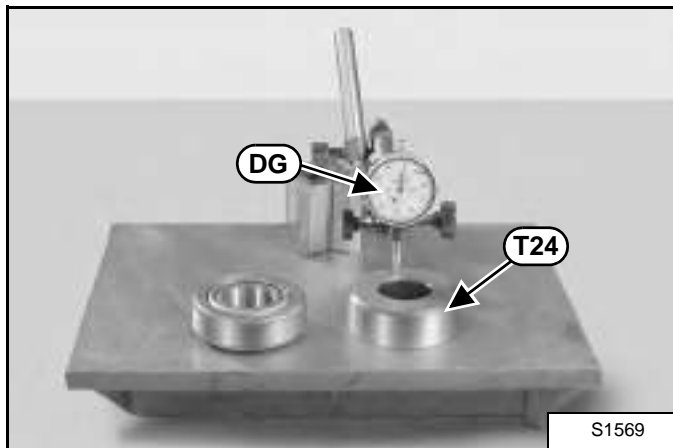

Using a surface plate, reset a magnetic based dial indicator and placing it on the measurement ring **T24** (with a thickness of 30,2 mm).  
Preset the indicator to approx. 2mm.

Figure 40-20-75

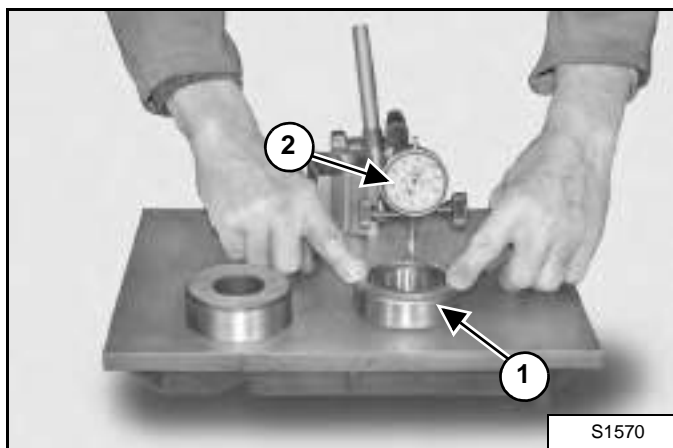

Bring the internal bearing (Item 1), complete with its bearing race, under the indicator (Item 2) [Figure 40-20-75].

Determine overall thickness "D" of the bearing checking the discrepancy between this size and the size of the measurement ring.

**NOTE:** Press the bearing race in the centre and take several measurements while rotating the bearing race.

Figure 40-20-76

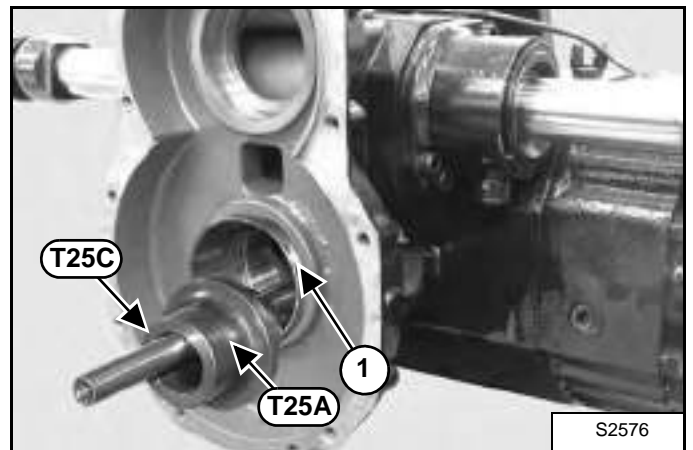

Partially insert the bearing race (Item 1) [Figure 40-20-76]

Figure 40-20-77

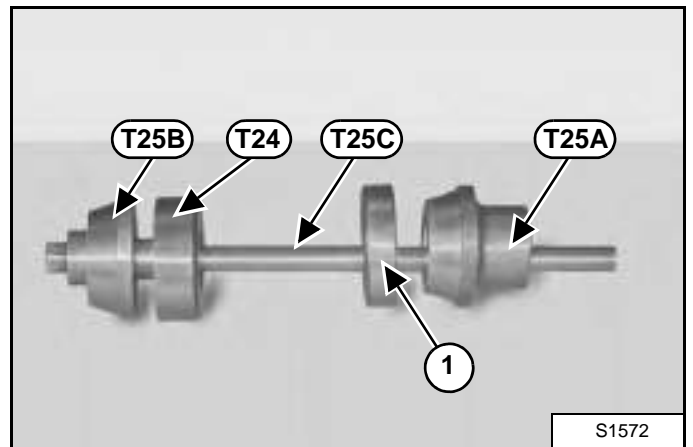

Install tension rod **T25C**, measurement ring **T24** and front guide tool **T25A** on the bearing race (Item 1) [Figure 40-20-77].

## AXLE AND DIFFERENTIAL (FRONT) (CONT'D)

### Bevel Pinion Assembly (Cont'd)

Figure 40-20-78

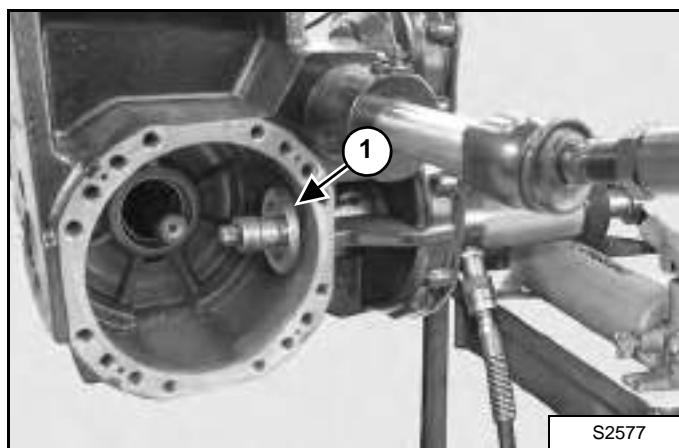

Connect the tension rod to the press and move the bearing race (Item 1) [Figure 40-20-78] into its seat. Disconnect the press and remove the tension rod.

**NOTE:** Before starting the next stage, make sure that the bearing race has been completely inserted into its seat.

Figure 40-20-79

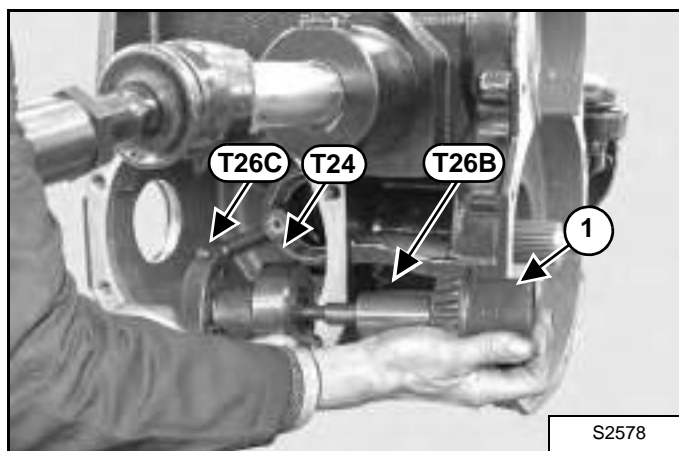

Insert tool **T26B** complete with external bearing (Item 1) [Figure 40-20-79], measurement ring **T24** and gauged ring nut **T26C**. Manually tighten.

Figure 40-20-80

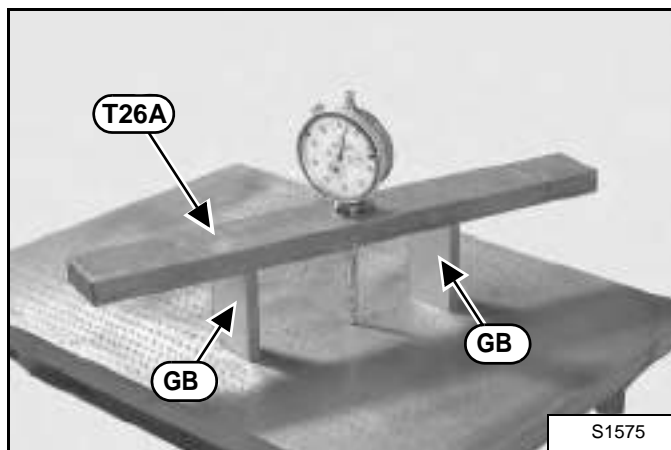

Fit a magnetic based dial indicator with long stem into bar **T26A**; when the bar rests on two size-blocks "GB" of 57mm, reset the indicator. Preset the indicator to approx. 2 mm and reset [Figure 40-20-80].

Figure 40-20-81

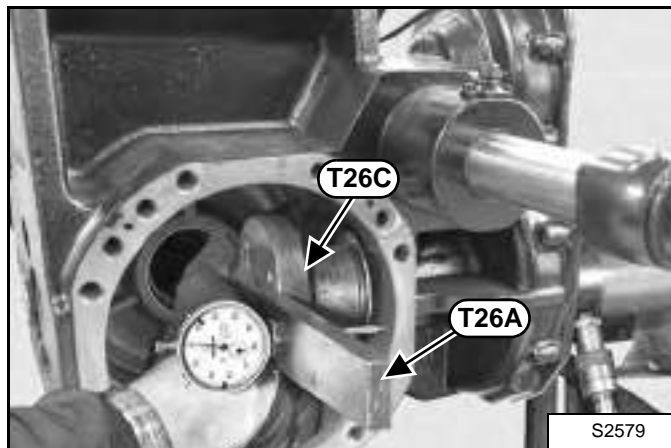

Lay bar **T26A** on gauged nut **T26C** and take the size "A" at about 57 mm corresponding to the maximum diameter of arms centring [Figure 40-20-81].

## AXLE AND DIFFERENTIAL (FRONT) (CONT'D)

### Bevel Pinion Assembly (Cont'd)

Figure 40-20-82

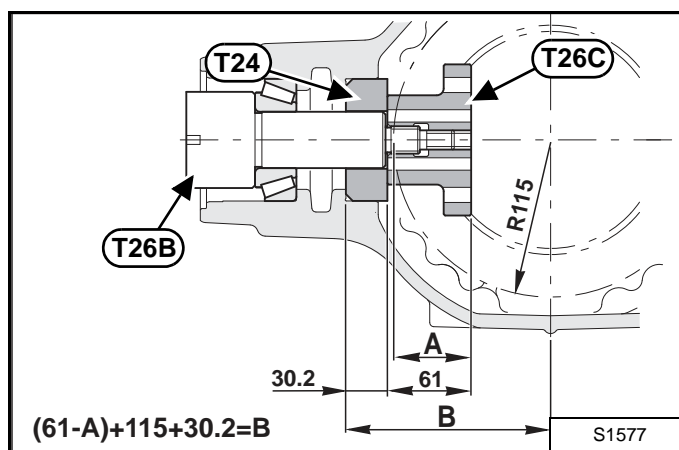

Calculate size "B" which will be the first useful value for calculating the size of the shims that are to be inserted under the bearing race [Figure 40-20-82].

Figure 40-20-83

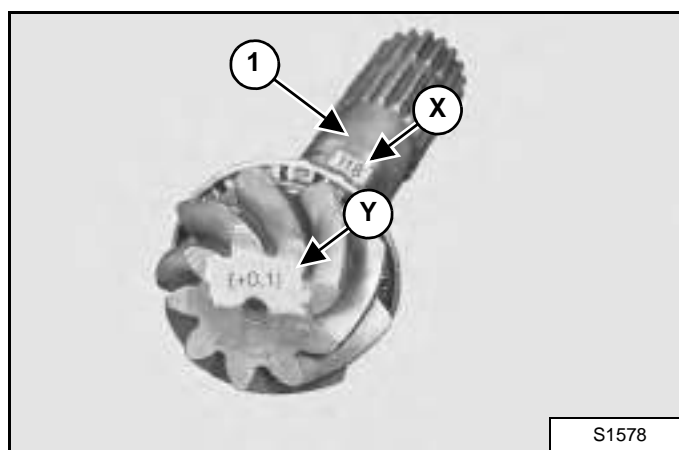

Check the nominal size (X) marked on the pinion (Item 1) [Figure 40-20-83] and add or subtract the indicated variation (Y) so as to obtain size (Z).

e.g.:  $Z = 118 + 0,1 = 118.1$   
 $Z = 118 - 0.2 = 117.8$

Figure 40-20-84

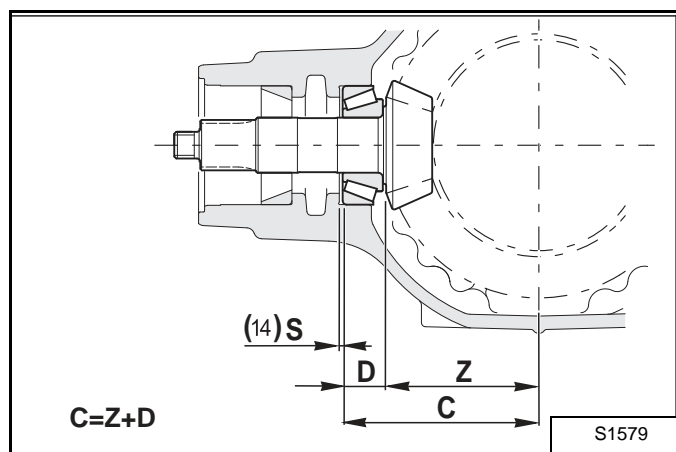

Calculate size "C" which represents the second value for calculating the size of the shims "S" that are to be placed under the bearing race [Figure 40-20-84].

Figure 40-20-85

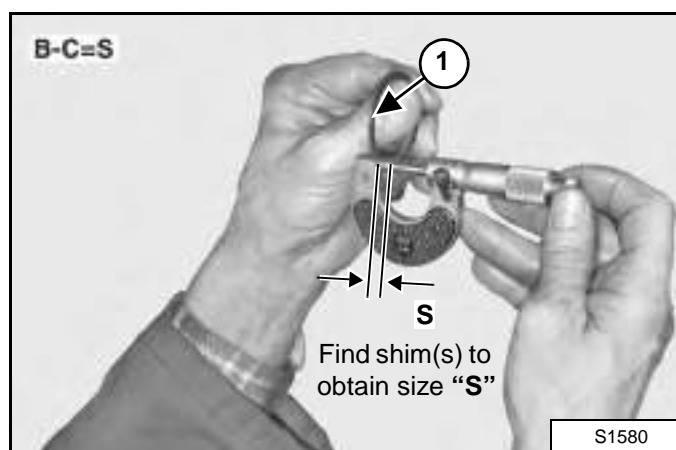

Calculate the difference between sizes "B" and "C" so as to obtain the size "S" of the shim (Item 1) [Figure 40-20-85] that will go under the bearing race.

## AXLE AND DIFFERENTIAL (FRONT) (CONT'D)

### Bevel Pinion Assembly (Cont'd)

Figure 40-20-86

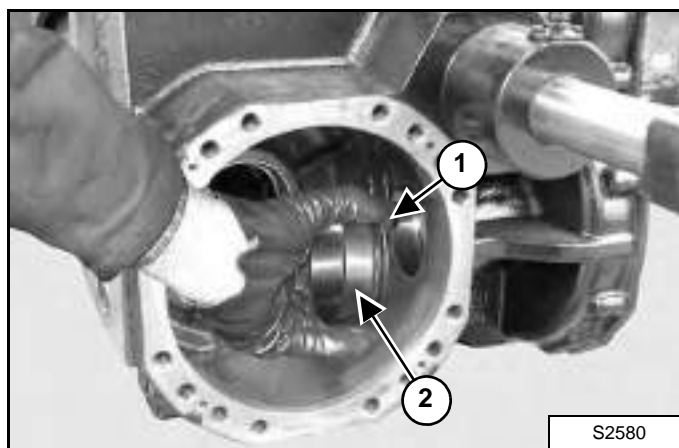

Insert shim "S" (Item 1) and the bearing race of the internal bearing (Item 2) [Figure 40-20-86] in the central body.

Figure 40-20-87

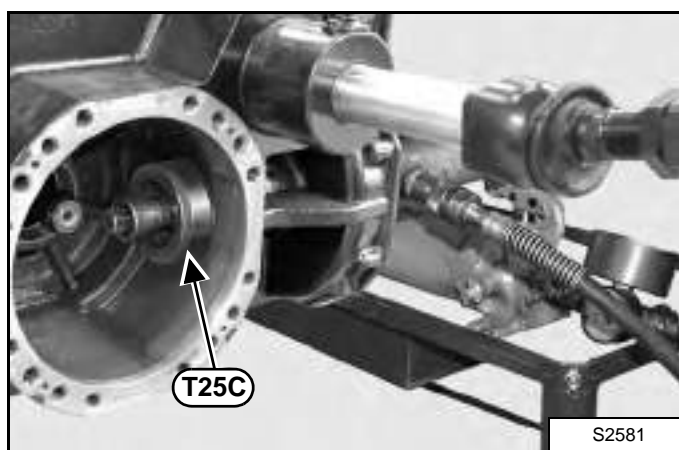

Connect the tension rod to the press, fasten the bearing race and then remove the tools [Figure 40-20-87].

**NOTE:** Before going on to the next stage, make sure that the bearing race has been completely inserted.

Figure 40-20-88

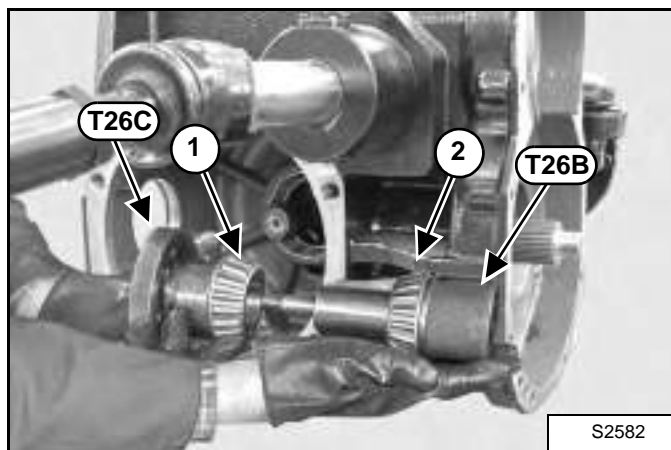

Position tools **T26C** and **T26B** complete with tapered bearings (Item 1 and 2) [Figure 40-20-88]; manually tighten until a rolling torque has been obtained.

Figure 40-20-89

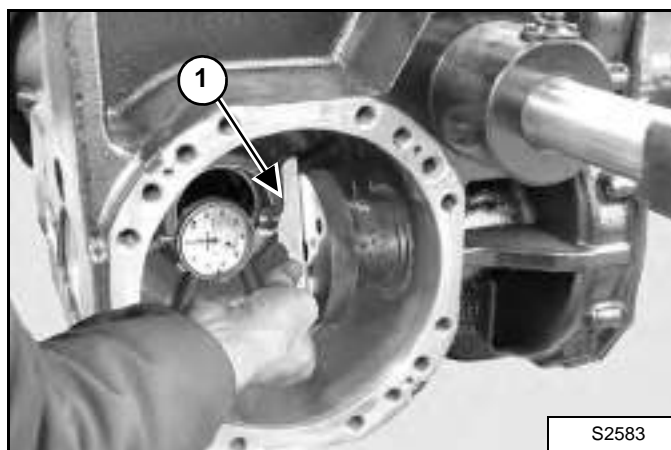

Insert the stem of a depth gauge (Item 1) [Figure 40-20-88] in either side hole of tool **T26C**; reset the indicator with a presetting of approx. 3 mm.

## AXLE AND DIFFERENTIAL (FRONT) (CONT'D)

### Bevel Pinion Assembly (Cont'd)

Figure 40-20-90

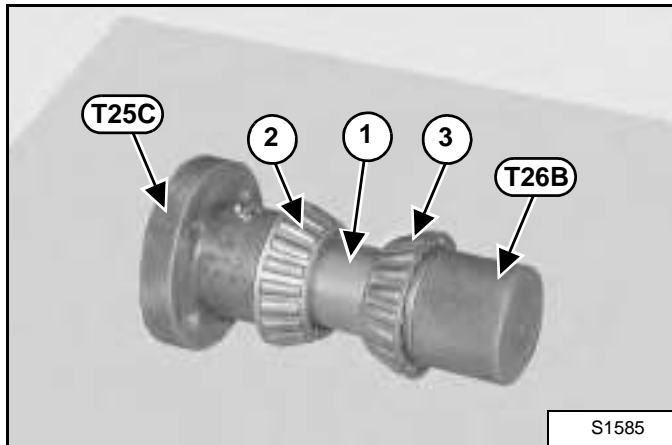

Remove the indicator and release tools and bearings from the central body.

Re-install all and insert the distance piece (Item 1) between both bearings (Item 2 and 3) [Figure 40-20-90]; manually tighten the whole pack.

Figure 40-20-91

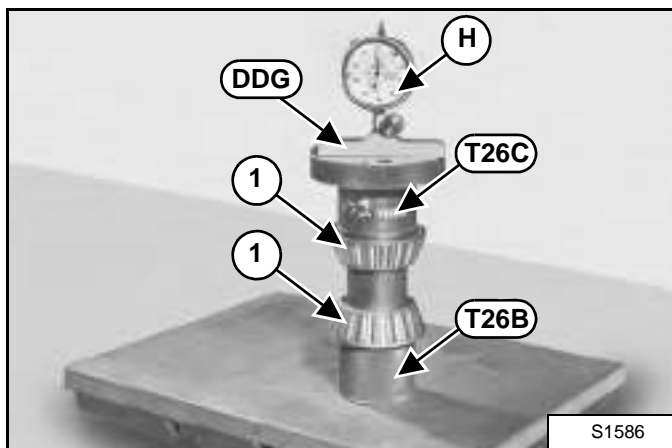

Insert depth gauge into tool **T26B-T26C** and measure variation "H" in relation to the zero setting performed in [Figure 40-20-89].

Figure 40-20-92

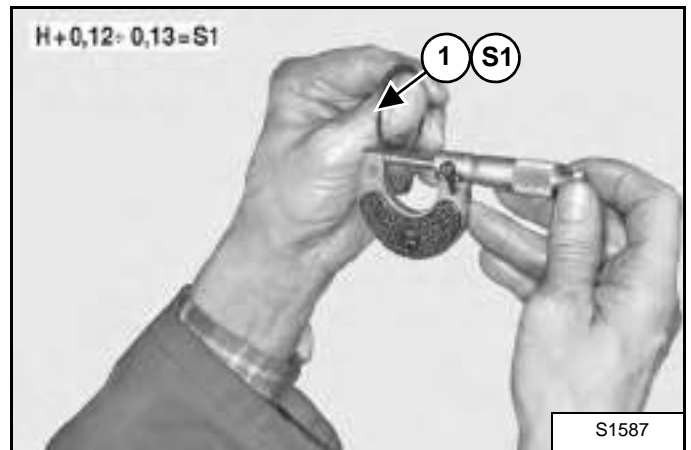

The variation is to be added to a set value of 0,12-0,13 mm, so as to obtain the size of shim "S1" (Item 1) [Figure 40-20-92] which will be inserted between the external bearing (Item 1) [Figure 40-20-91] and the distance piece (Item 1) [Figure 40-20-90] and subsequently, to determine the preload for the bearings.

Figure 40-20-93

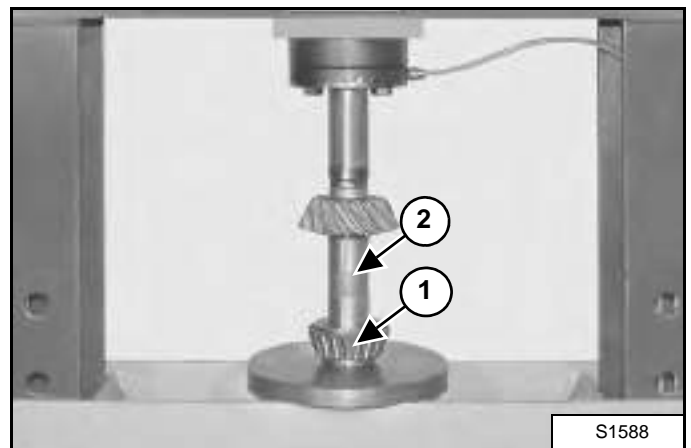

Position the internal bearing (Item 1) and the pinion (Item 2) [Figure 40-20-93] under a press. Force the bearing onto the pinion.

## AXLE AND DIFFERENTIAL (FRONT) (CONT'D)

### Bevel Pinion Assembly (Cont'd)

Figure 40-20-94

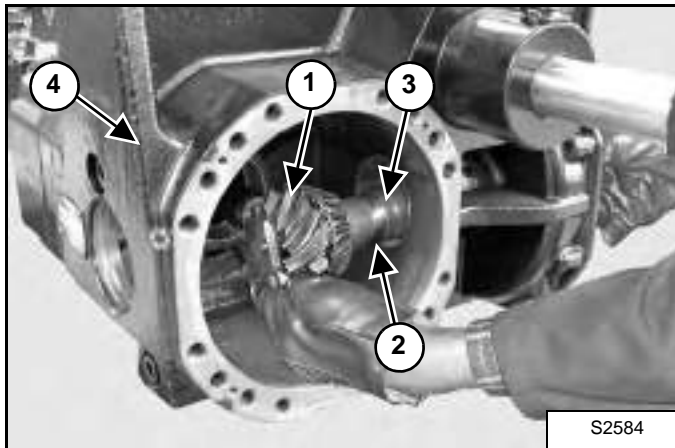

Fit the pinion (Item 1), shim "S1" (Item 2) and the distance piece (Item 3) in the main body (Item 4) [Figure 40-20-94].

**NOTE:** If multiple shims are used, always position the thinner shims in between the thicker shims.

Figure 40-20-95

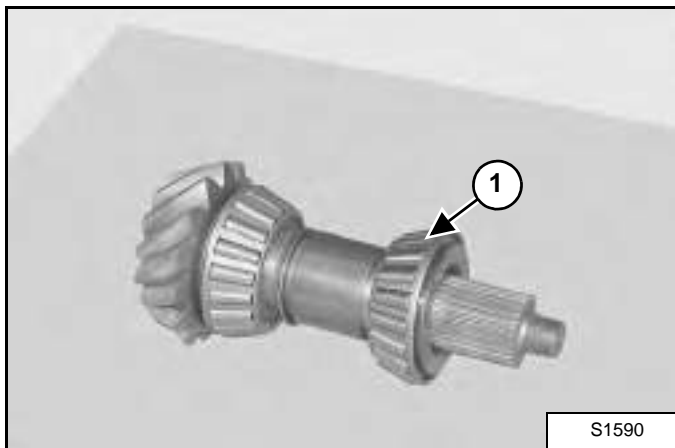

Insert the external bearing (Item 1) [Figure 40-20-95] in the central body in order to complete the pack arranged as in the figure.

Figure 40-20-96

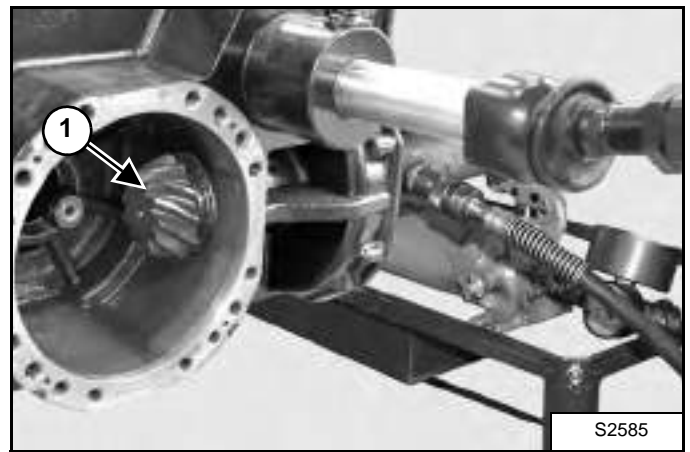

Connect the pinion (Item 1) [Figure 40-20-96] to the tie rod T28A and T28B. Connect the tie rod T28C to the press and block.

Figure 40-20-97

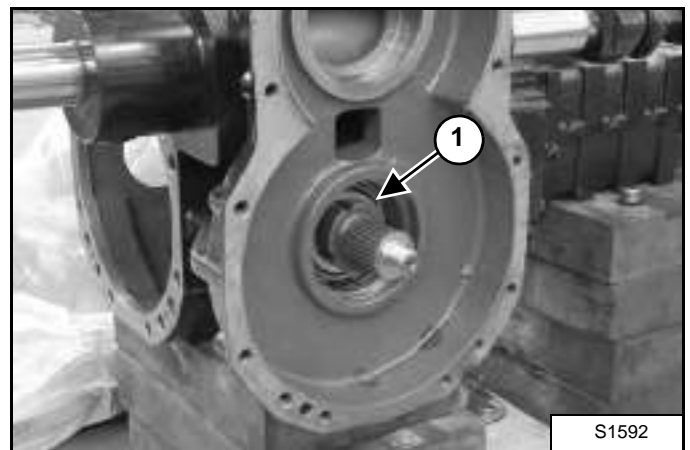

Apply Loctite 242 to the thread of the ring nut (Item 1) [Figure 40-20-97] and screw the nut onto the pinion.



## AXLE AND DIFFERENTIAL (FRONT) (CONT'D)

### Bevel Pinion Assembly (Cont'd)

Figure 40-20-98

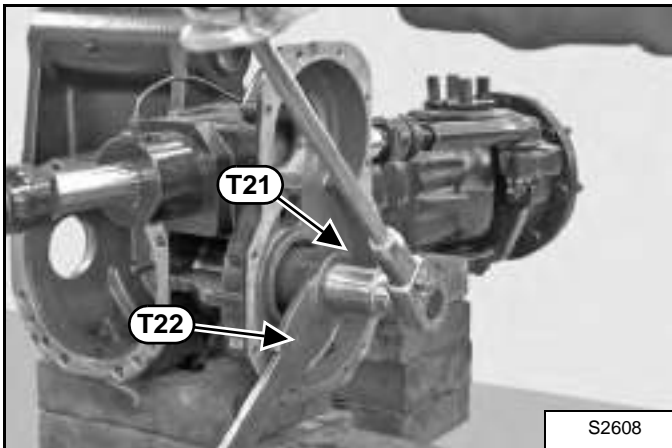

Apply special wrench **T22** to the ring nut and bar-hold **T21** to the pinion .

Lock the wrench **T22** and rotate the pinion using a dynamometric wrench, up to a minimum required torque setting of 370 ft.-lb. (500 N•m) [Figure 40-20-97].

Figure 40-20-99

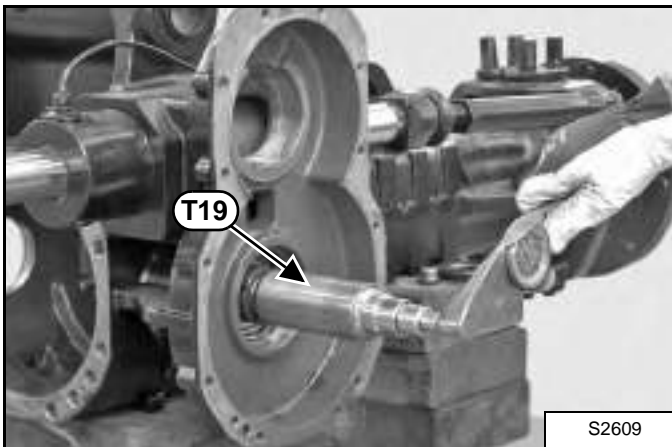

The rolling torque of the pinion shaft must be checked. Using a dial indicator torque wrench, measure the rolling torque. The correct torque is 0.88 - 1.25 ft.-lb. (1,20-1,70 N•m) [Figure 40-20-98].

**NOTE:** If torque exceeds the maximum value, then the size of shim "S1" between the bearing and the distance piece needs to be increased.

**NOTE:** If torque does not reach the set value, increase the torque setting of the ring nut in different stages to obtain a maximum value of 420 ft.-lb. (570 N•m) (see the step under [Figure 40-20-97]).

**NOTE:** If torque does not reach the minimum value, then the size of shim "S1" needs to be reduced.

**NOTE:** When calculating the increase or decrease in size of shim "S1", bear in mind that a variation of shim of 0,01 mm corresponds to a variation of 0.44 ft.-lb. (60 N•m) in the torque of the pinion.

## AXLE AND DIFFERENTIAL (FRONT) (CONT'D)

### Bevel Pinion Assembly (Cont'd)

Figure 40-20-100

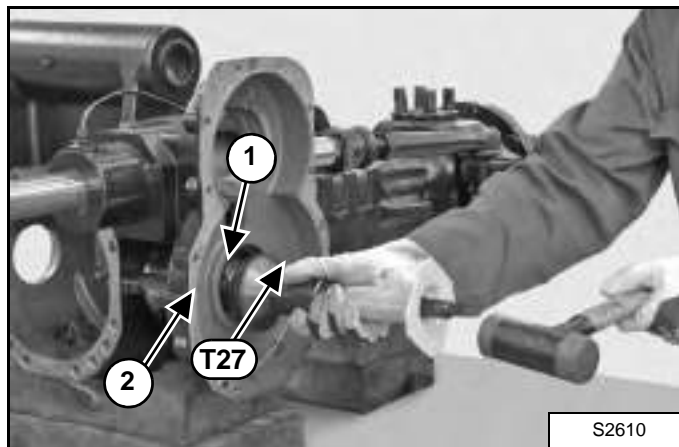

Lubricate the outer surface of the new sealing ring (Item 1) and fit it onto the central body (Item 2) [Figure 40-20-100] using tool T27.

**NOTE:** Check that it is properly oriented.

Figure 40-20-101

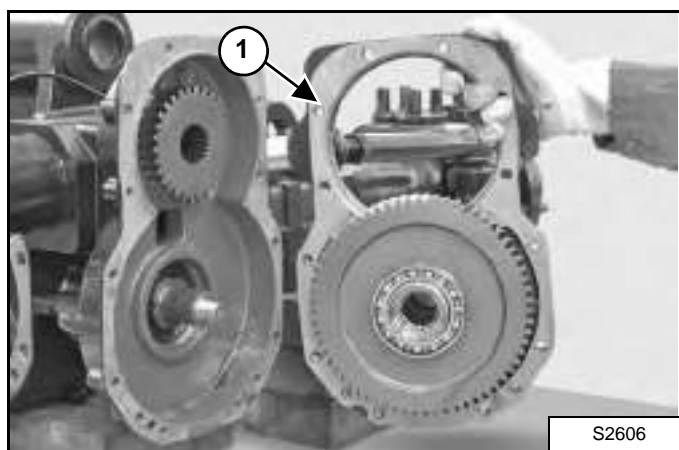

Install the drive side flange cover (Item 1) [Figure 40-20-101].

Figure 40-20-102

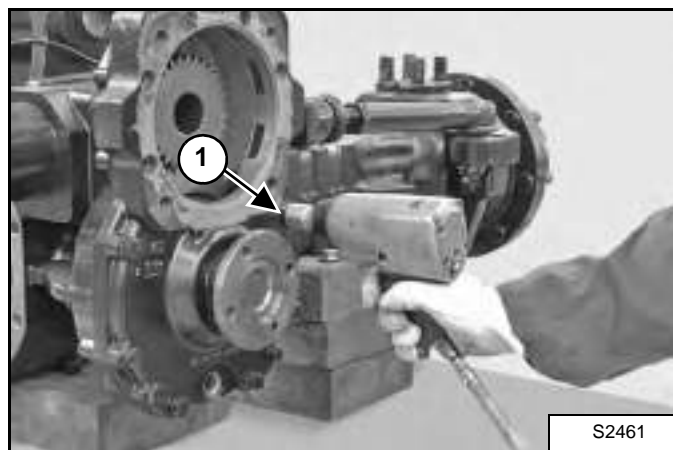

Tighten the screws (Item 1) [Figure 40-20-102] of the drive side flange cover.

## AXLE AND DIFFERENTIAL (FRONT) (CONT'D)

### Bevel Pinion Assembly (Cont'd)

Figure 40-20-103

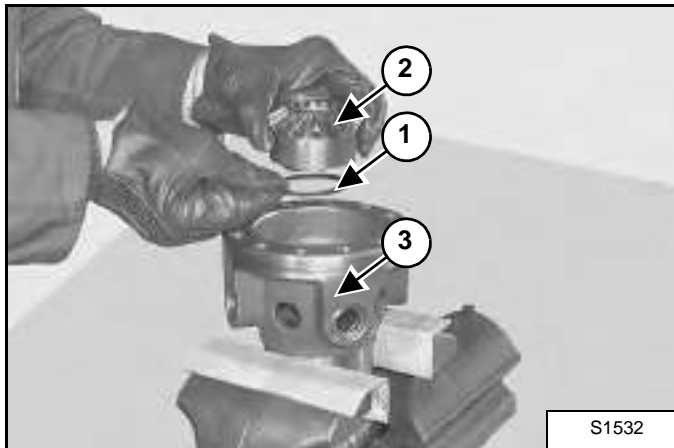

Insert the thrust washer (Item 1) and the planetary gear (Item 2) in the differential carrier (Item 3) [Figure 40-20-103].

Figure 40-20-104

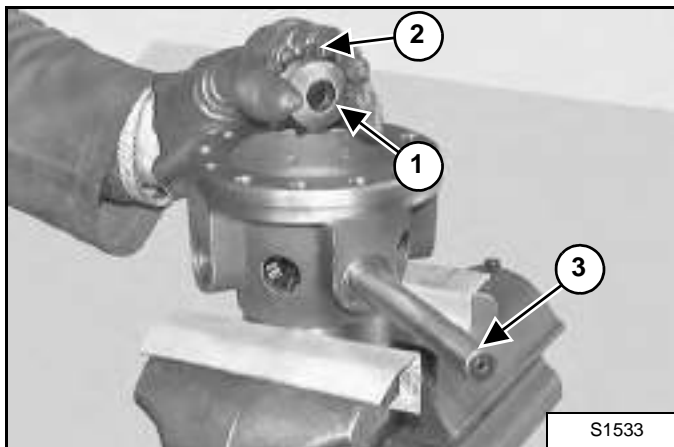

Position the thrust washer (Item 1) and the first planet wheel gear (Item 2). Temporarily hold them in position using a bar (Item 3) [Figure 40-20-104].

Figure 40-20-105

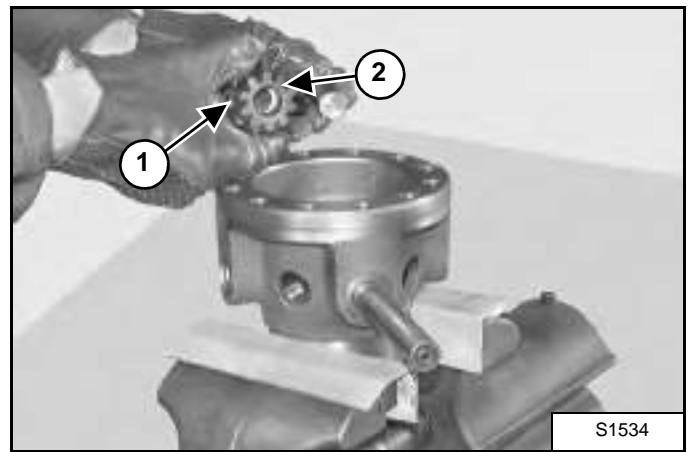

With the help of a bar, position the second planet wheel gear (Item 1) and the relative thrust washer (Item 2) [Figure 40-20-105].

Figure 40-20-106

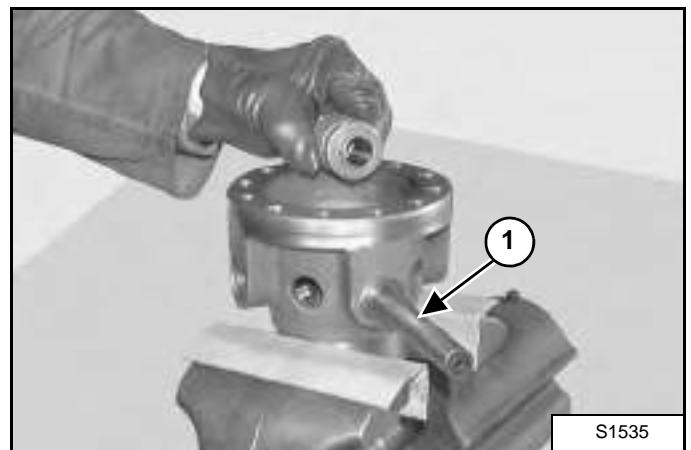

Insert a tool between the two planetary gears and line up the entire unit by pushing the bar (Item 1) [Figure 40-20-106] all the way down until it is ejected.

## AXLE AND DIFFERENTIAL (FRONT) (CONT'D)

### Differential assembly

Figure 40-20-107

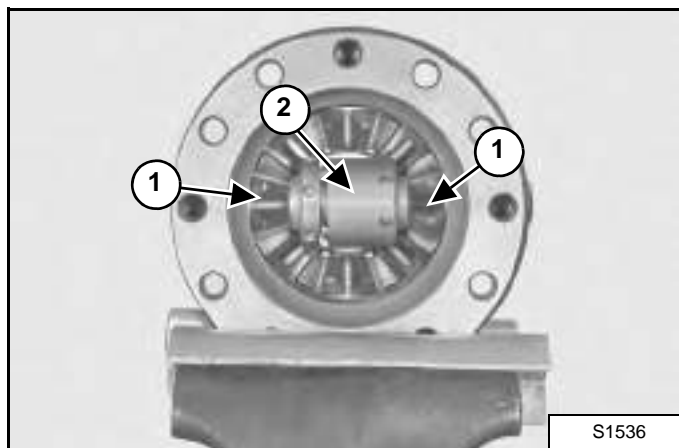

Lock tool (Item 2) behind the planet wheel gears (Item 1) [Figure 40-20-107]. After locking, remove the bar.

Figure 40-20-108

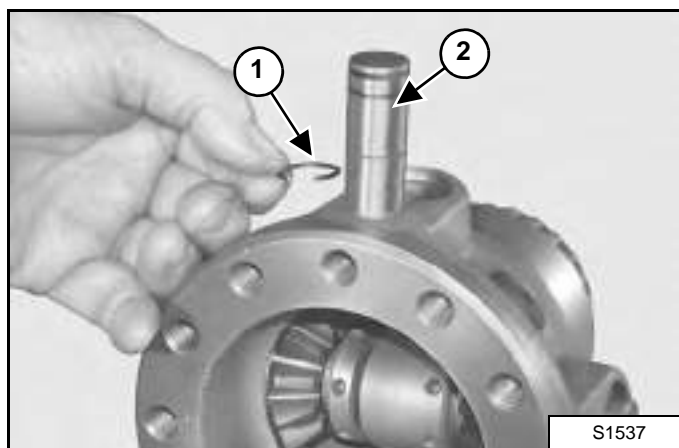

Fit the snap rings (Item 1) onto the pins (Item 2) [Figure 40-20-108].

Figure 40-20-109

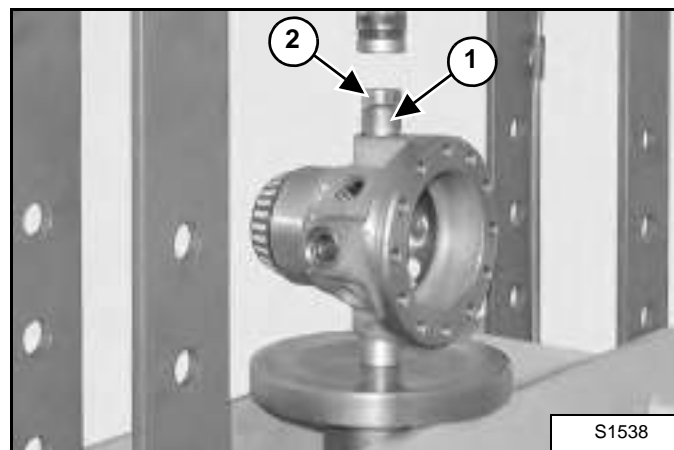

Place the differential carrier under the press, position bushing (Item 1) and insert the planet wheel pin (Item 2) [Figure 40-20-109].

Figure 40-20-110

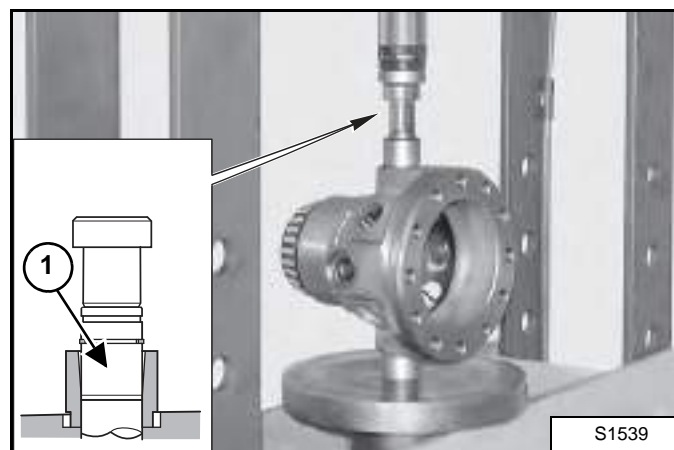

Put a tool pin (Item 1) [Figure 40-20-110] on top of the planet wheel pin.

## AXLE AND DIFFERENTIAL (FRONT) (CONT'D)

### Differential assembly (Cont'd)

Figure 40-20-111

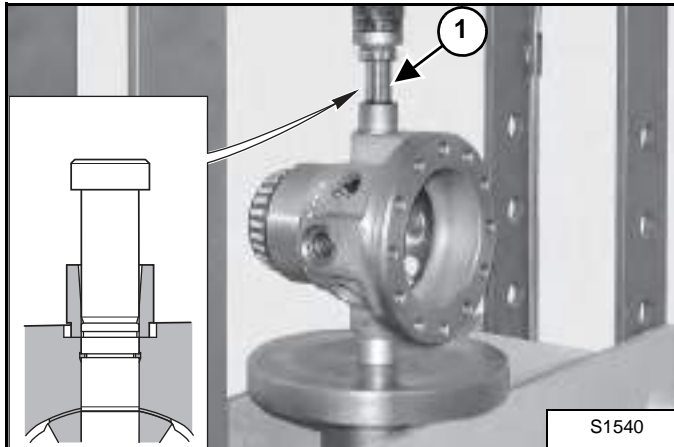

Press the pin all the way down (Item 1) [Figure 40-20-111]

Figure 40-20-112

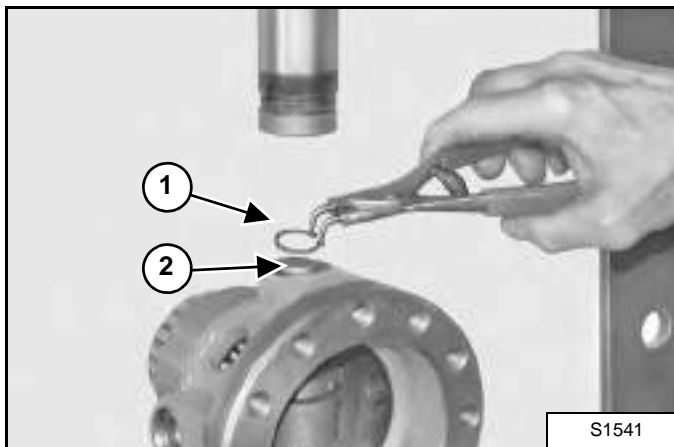

Remove the tool pin, bushing and fit the snap ring (Item 1) on the pin (Item 2) [Figure 40-20-112].

**NOTE:** Make sure that the snap ring centers the seat and that it rests on the surface of the differential carrier.  
Repeat the operations on the other planet wheel pin or planet wheel axle.

Figure 40-20-113

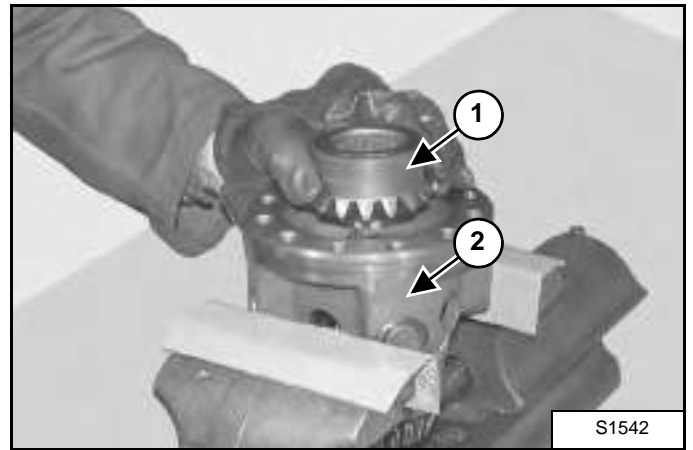

Position the second planetary gear (Item 1) in the differential carrier (Item 2) [Figure 40-20-113].

Figure 40-20-114

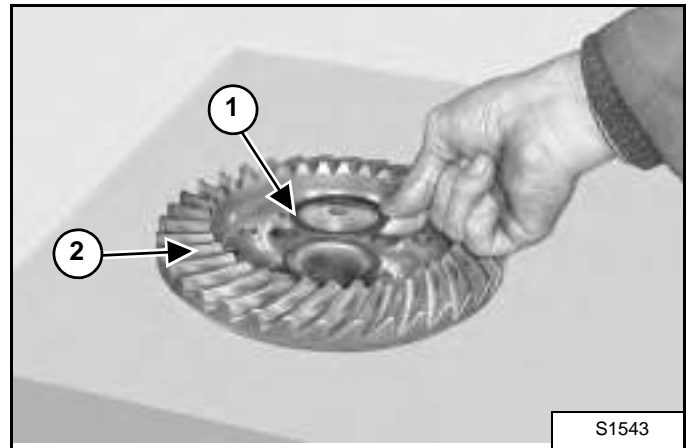

Position the thrust washer (Item 1) on the crown (Item 2) [Figure 40-20-114].

**NOTE:** In order to hold the shim washer in position, apply grease to it.

## AXLE AND DIFFERENTIAL (FRONT) (CONT'D)

### Differential assembly (Cont'd)

Figure 40-20-115

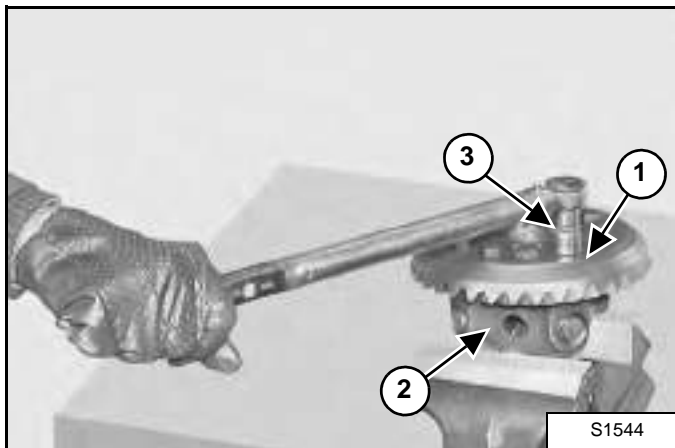

Position the crown (Item 1) on the differential carrier (Item 2) and lock it with screws (Item 3) [Figure 40-20-115] applied with Loctite 242.

Tighten to a torque of 95 - 105 ft.-lb. (128-142 N•m).

**NOTE:** Secure the screws using the cross tightening method.

Figure 40-20-116

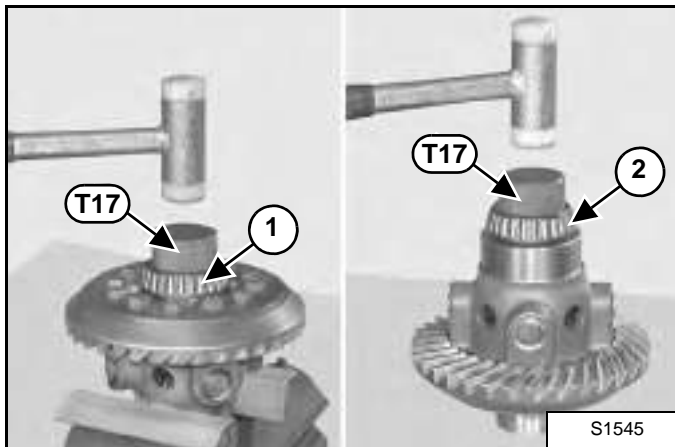

Install the bearing races (Item 1 and 2) [Figure 40-20-116] using tool T17.

Figure 40-20-117

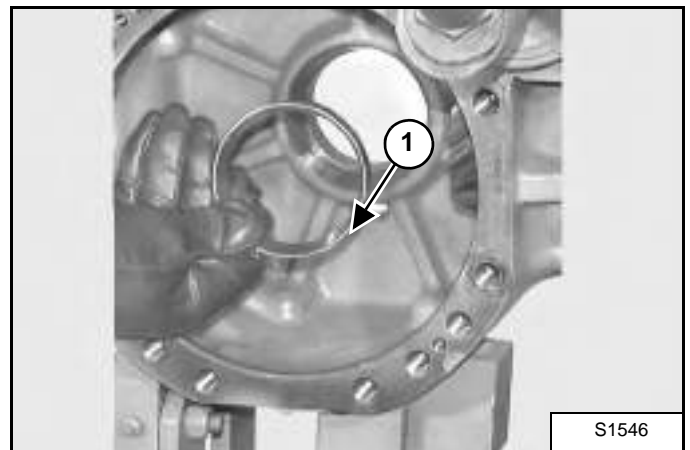

If the bearings are replaced, insert the external bearing races in the middle cover (Item 1) [Figure 40-20-117] and in the central body.

Figure 40-20-118

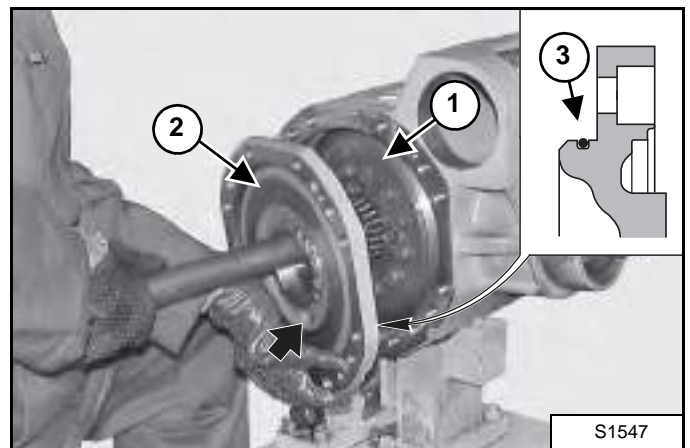

Position the differential unit in the central body (Item 1) with the help of a bar and fit the middle cover (Item 2) [Figure 40-20-118].

**NOTE:** Thoroughly check the state of the O-ring (Item 3) [Figure 40-20-118] and make sure that the cover is fitted with the hole (see arrow on [Figure 40-20-118]) in the lower position.

## AXLE AND DIFFERENTIAL (FRONT) (CONT'D)

### Differential assembly (Cont'd)

Figure 40-20-119

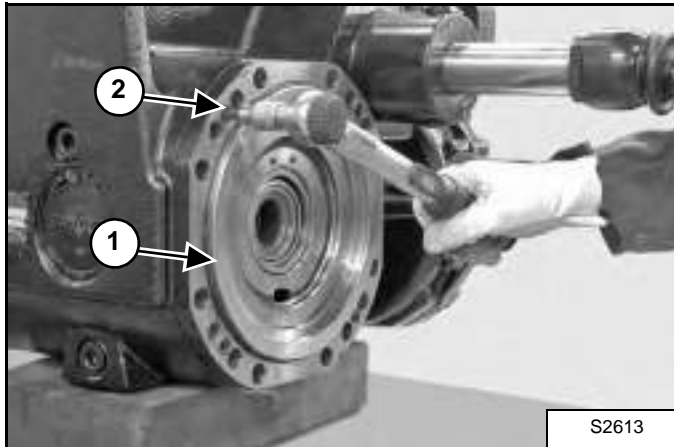

Lock the middle cover (Item 1) with screws (Item 2) [Figure 40-20-119]. Tighten to a torque of 17.5 - 19.5 ft.-lb. (23,8-26,2 N•m).

### Setting Ring And Pinion Backlash

Figure 40-20-120

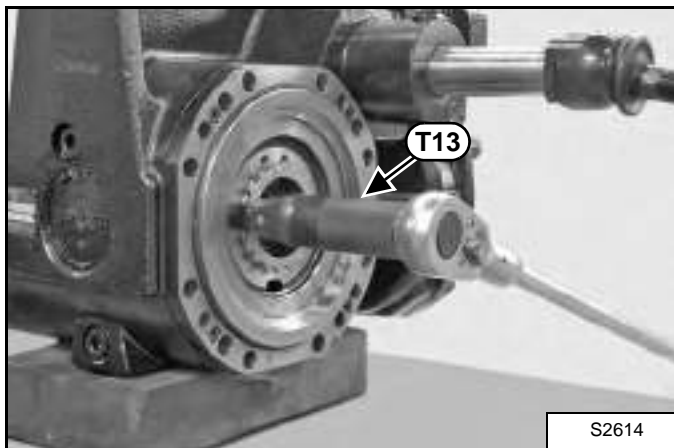

**NOTE:** If the lock nuts (Item 1) [Figure 40-20-44] are removed, apply some Loctite 242 to them. Tighten lock nuts on the crown side until clearance between pinion and crown is zero, then lock the crown. Go back 1/4—1/2 turn.

Figure 40-20-121

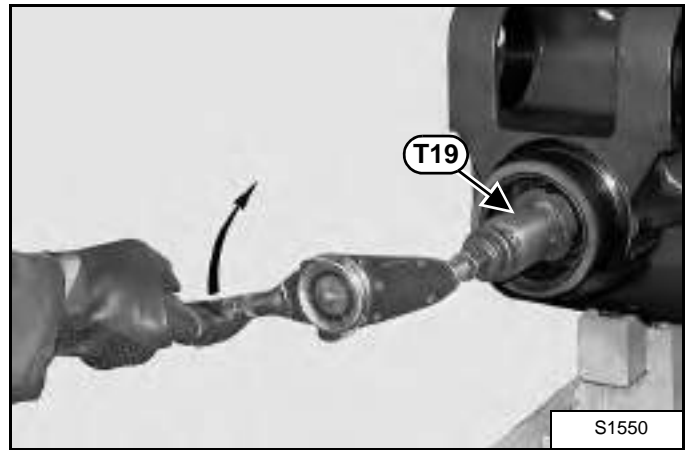

Pre-set the bearings by means of the ring nut situated on the opposite side of the crown, so as to increase pinion torque up to 1.0 - 1.55 ft.-lb. (1,40- 2,10 N•m) [Figure 40-20-121].

**NOTE:** If bearings are not new, check the static torque. If bearings are new, check the continuous torque.

Figure 40-20-122

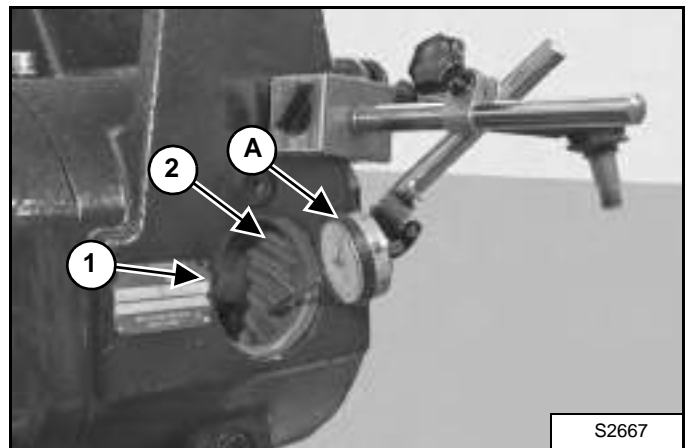

Introduce a dial indicator with rotary key "A" through the plug hole (Item 1). Position the indicator on the centre of one of the teeth of the crown (Item 2) [Figure 40-20-122] and pre-set it to 1 mm and reset it.



## AXLE AND DIFFERENTIAL (FRONT) (CONT'D)

### Differential assembly (Cont'd)

Figure 40-20-123

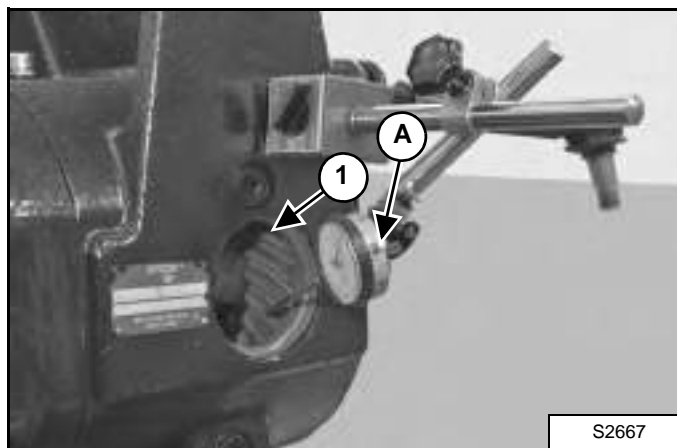

Manually move the crown (Item 1) [Figure 40-20-123] in both directions in order to check the existing backlash between the pinion and the crown.

Figure 40-20-124

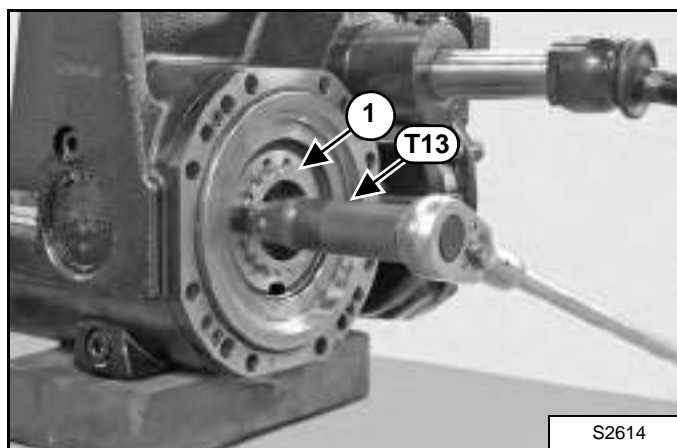

Adjust the backlash between the pinion and the crown by loosening one of the ring nuts (Item 1) [Figure 40-20-124] and tightening the opposite to compensate.

Normal backlash: see table.

RATIO	CLEARANCE	
	MIN.	MAX.
14—32	0.18	0.23

**NOTE:** Difference between MIN and MAX clearance for whole circumference should not exceed 0,09 mm.

Figure 40-20-125

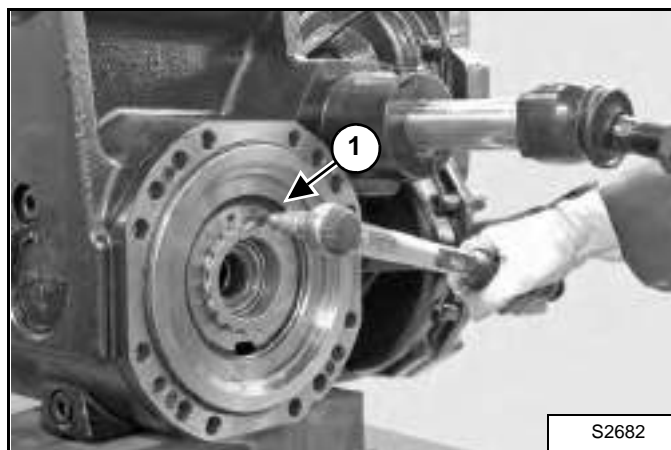

Apply Loctite 242 to the screws (Item 1), fit them into one of the two holes and tighten.

Tighten to a torque of 17.5 - 19.3 ft.-lb. (23,8 - 26,2 N•m).

Fit the plug in the hole (Item 1) [Figure 40-20-122] after applying flexible gasket compound for seals to the rims.



AXLE AND DIFFERENTIAL (FRONT) (CONT'D)

Brake System Assembly

Figure 40-20-126

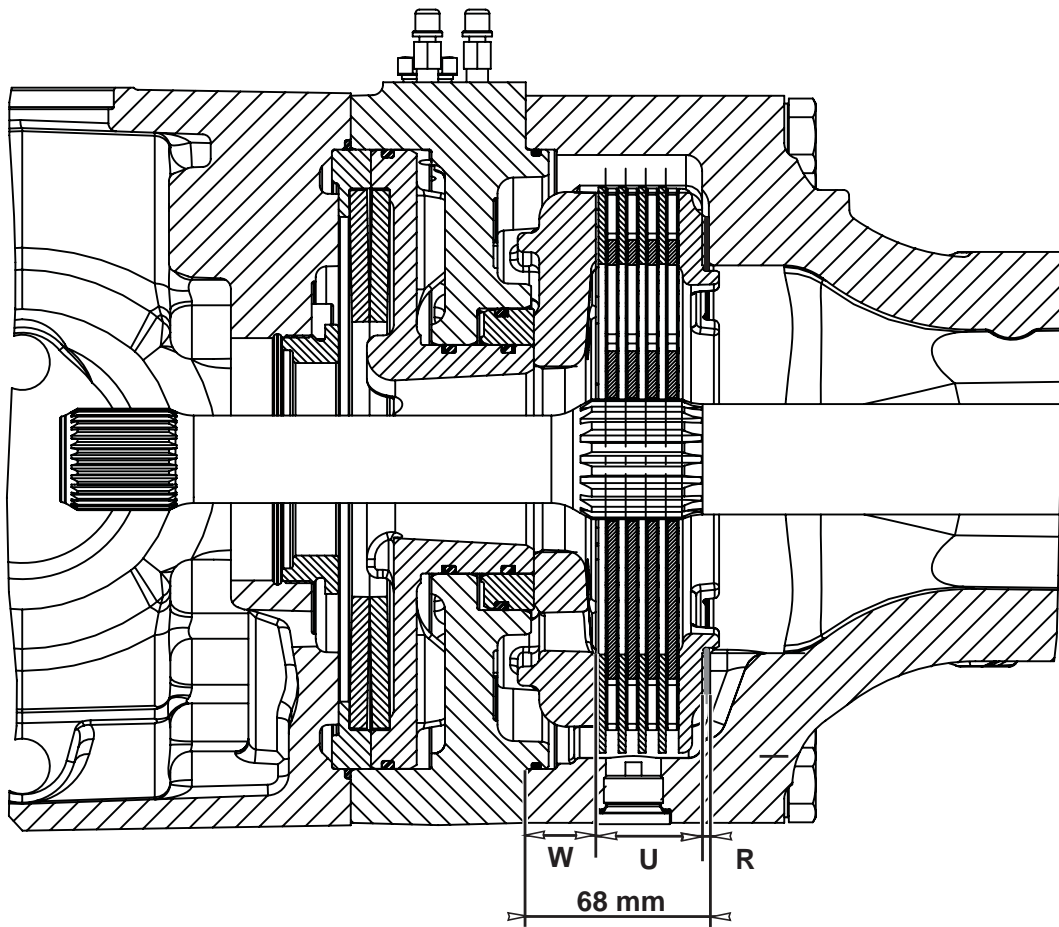

Y = Brake gap  
Y = 0,75 mm

S2735

## AXLE AND DIFFERENTIAL (FRONT) (CONT'D)

### Brake System Assembly (Cont'd)

Figure 40-20-127

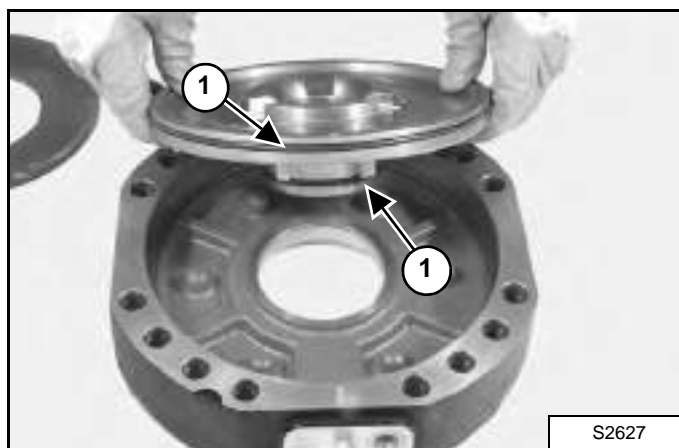

Fit O-rings (Item 1) [Figure 40-20-127] onto the piston. Lubricate the piston and the O-rings and install the unit into the cylinder.

Figure 40-20-128

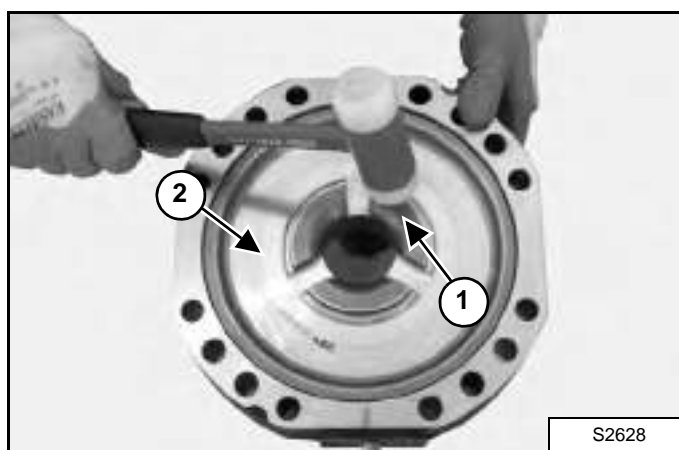

Using a plastic hammer, tap the piston (Item 1) into the cylinder (Item 2) [Figure 40-20-128].

**NOTE:** Lightly hammer all around the edge in an alternate sequence.

Figure 40-20-129

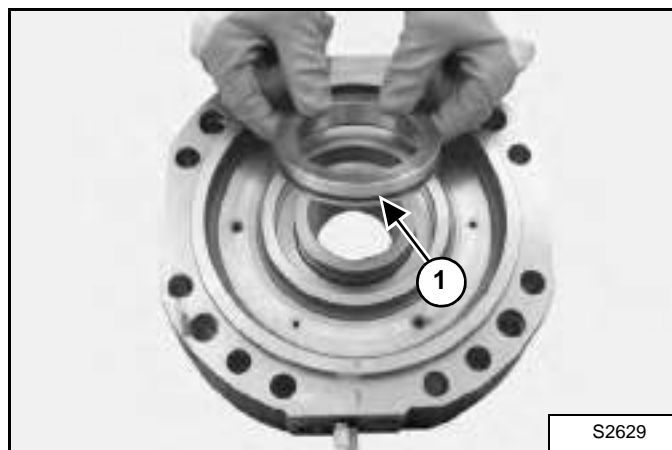

Fit O-rings (Item 1) [Figure 40-20-129] onto the piston. Lubricate the piston and the O-rings and install the unit into the cylinder.

Figure 40-20-130

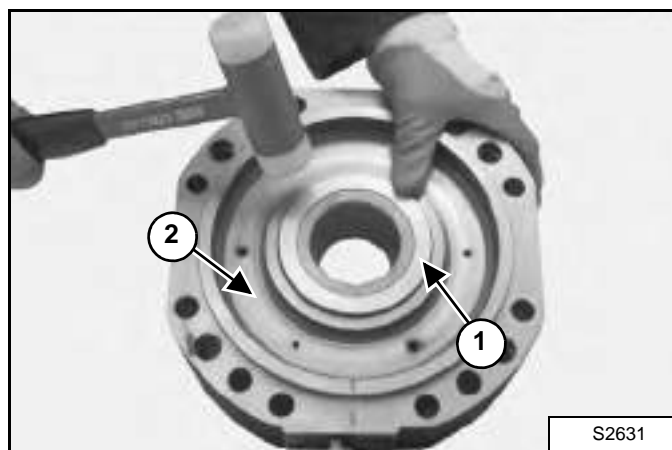

Using a plastic hammer, tap the piston (Item 1) into the cylinder (Item 2) [Figure 40-20-130].

**NOTE:** Lightly hammer all around the edge in an alternate sequence.

## AXLE AND DIFFERENTIAL (FRONT) (CONT'D)

### Brake System Assembly (Cont'd)

Figure 40-20-131

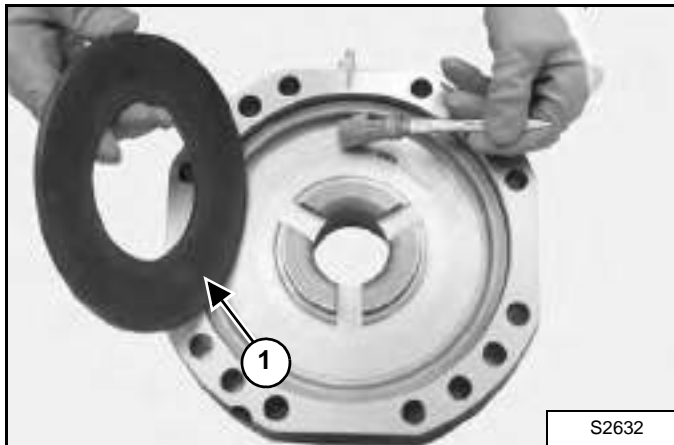

Clean and grease the surface, position the Belleville washers (Item 1) [Figure 40-20-131] and engage the cylinder.

**NOTE:** Check the sense of direction of washers and relative centring.

Figure 40-20-132

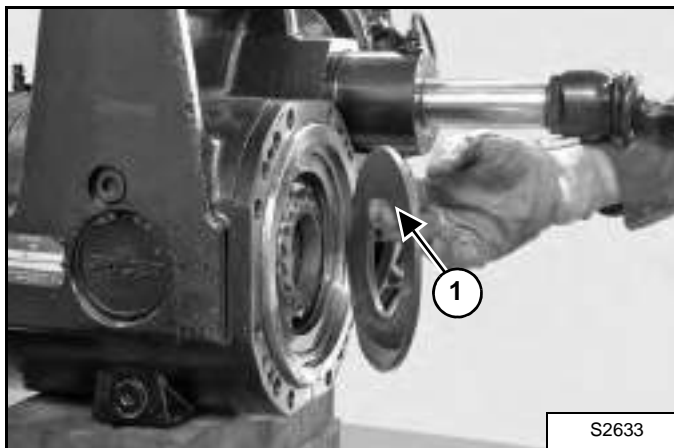

Position the Belleville washers (Item 1) [Figure 40-20-132] and engage the cylinder.

Figure 40-20-133

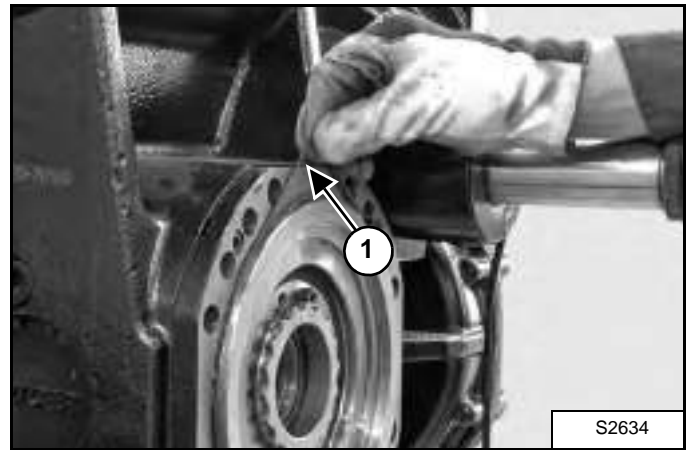

Install the O-ring (Item 1) [Figure 40-20-133].

Figure 40-20-134

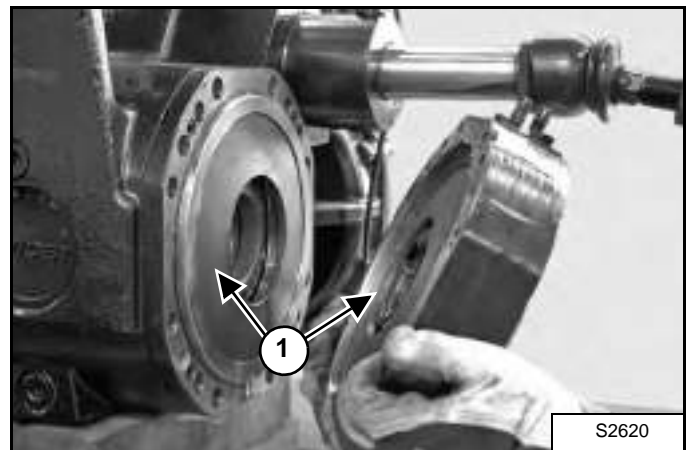

Position the Belleville washers (Item 1) [Figure 40-20-134] and engage the cylinder.

## AXLE AND DIFFERENTIAL (FRONT) (CONT'D)

### Brake System Assembly (Cont'd)

Figure 40-20-135

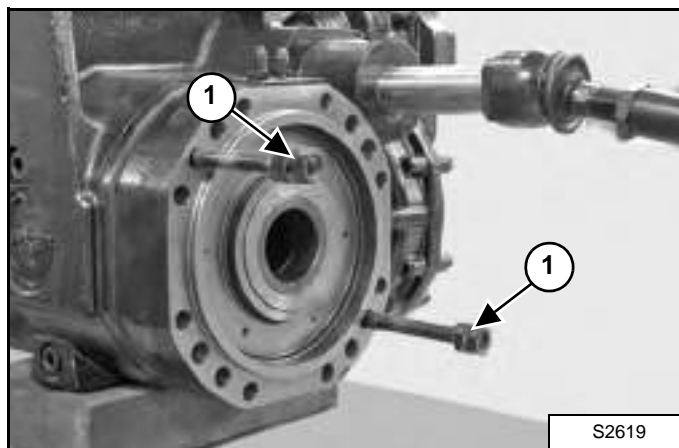

Tighten the studs (Item 1) [Figure 40-20-135] with a dynamometric wrench to set a torque of 22 - 33 ft.-lb. (30 - 45 N•m).

Figure 40-20-136

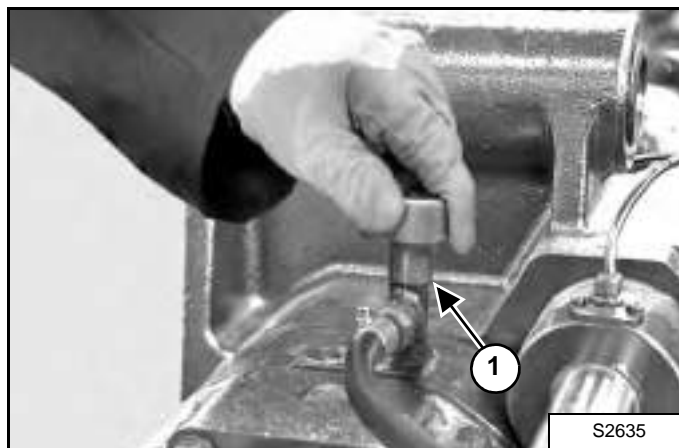

Connect an external pump to the negative brake (Item 1) [Figure 40-20-136] and introduce pressure to 217 - 435 PSI (15 - 30 Bar). Always use Bobcat hydraulic fluid.

Figure 40-20-137

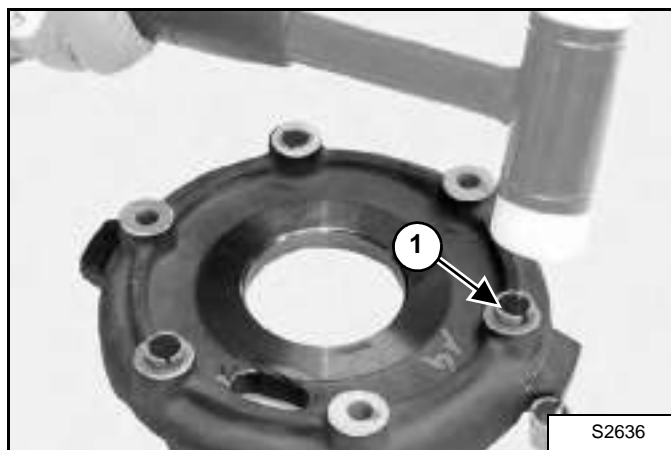

Insert the stroke automatic regulation springs (Item 1) [Figure 40-20-137], place them in line with the piston.

Figure 40-20-138

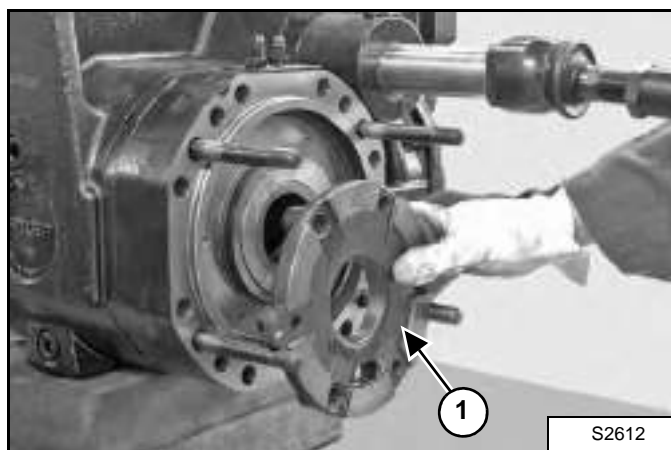

Insert the intermediate disk (Item 1) [Figure 40-20-138].

## AXLE AND DIFFERENTIAL (FRONT) (CONT'D)

### Brake System Assembly (Cont'd)

Figure 40-20-139

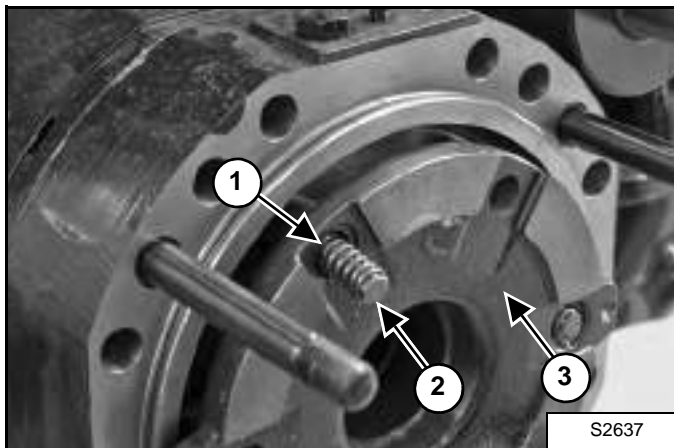

Install the six springs (Item 1) and the bolts (Item 2) into the piston (Item 3) [Figure 40-20-139].

Figure 40-20-140



Fit the pin screws making sure that they are all of the same colour [Figure 40-20-140].

Apply Loctite 270 to the thread and tighten to a torque of 3.7 - 5.2 ft.-lb. (5 - 7 N•m).

Figure 40-20-141

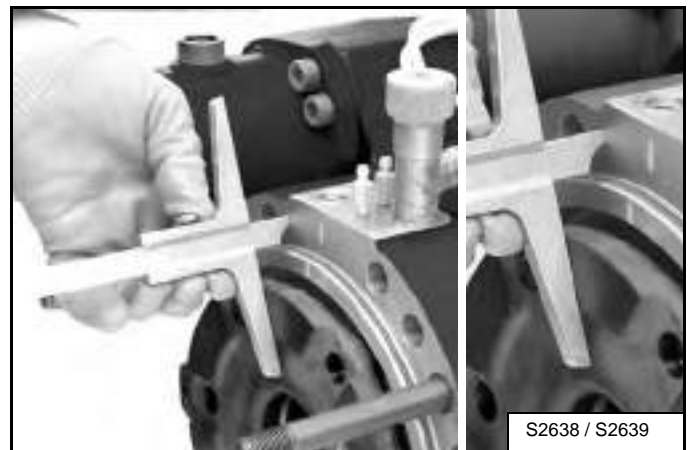

Take measure from the surface of the intermediate disk to the cover sealing surface with 435 PSI (30 bar) of pressure introduced. (example: 25,4 mm) [Figure 40-20-141].

Figure 40-20-142

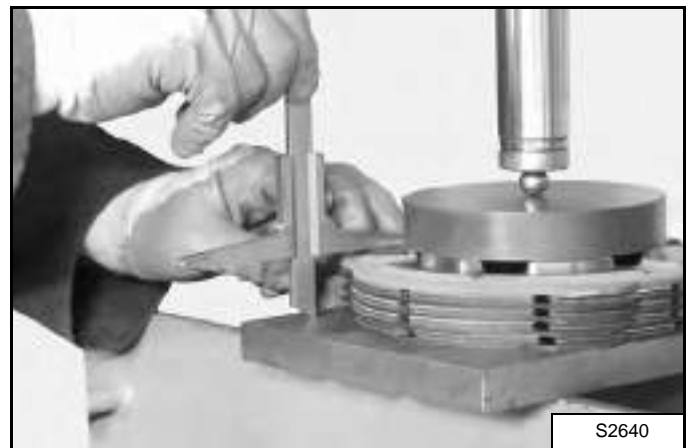

Put the brake disc pack including the shim under a press, load with 220 lbs. (100 kg) and take the measure "V". (example: 40 mm) [Figure 40-20-142].

## AXLE AND DIFFERENTIAL (FRONT) (CONT'D)

### Brake System Assembly (Cont'd)

Figure 40-20-143



$S = 68 \text{ mm} - (x + y + v) =$  Thickness of shims to insert under the shim washer.

See [Figure 40-20-126] for a sectional view showing these dimensions.

Figure 40-20-144

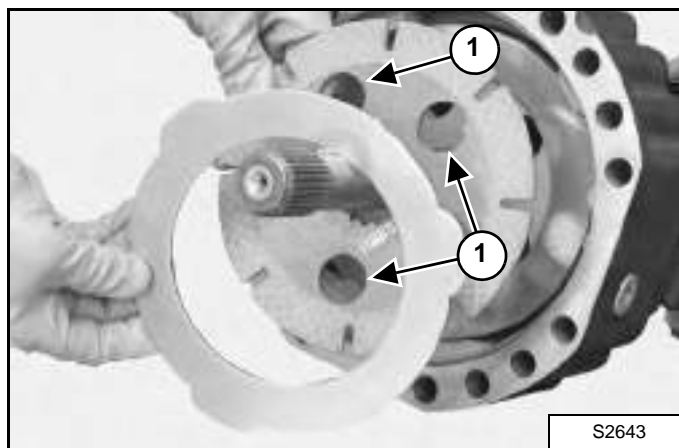

Slightly lubricate the braking disks with Bobcat hydraulic fluid and fit them in the arm following the correct sequence. Orient them so that the oil circulation holes and the holes (Item 1) [Figure 40-20-144] are perfectly lined up.

Figure 40-20-145

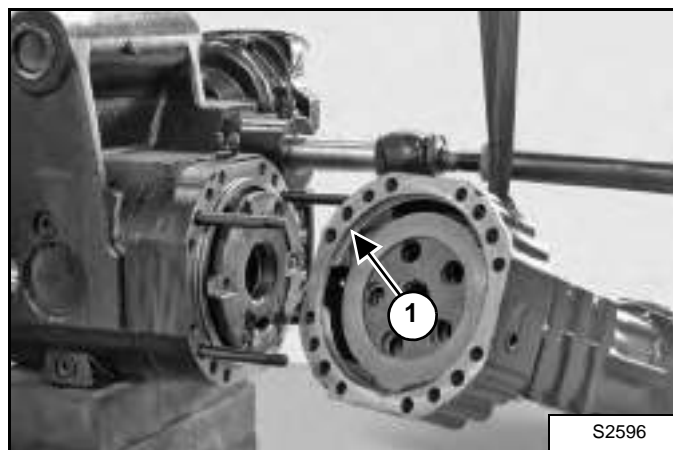

Check integrity and position of the arms' O-ring (Item 1) [Figure 40-20-145], install the complete arm.

**NOTE:** To assist axle shaft centring, slightly move the wheel hub.

---

## AXLE AND DIFFERENTIAL (FRONT) (CONT'D)

### Brake System Assembly (Cont'd)

Figure 40-20-146

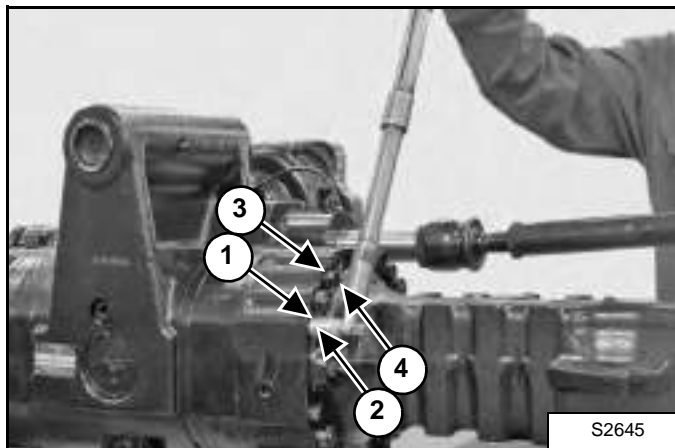

Install the four washer (Item 1) and nuts (Item 2), tighten nuts to 150 ft.-lb. (200N•m) torque. Install the twelve washer (Item 3) and bolts (Item 4) [Figure 40-20-146], tighten the bolts to 209 ft.-lb. (283 N•m).

**NOTE:** Tighten using the criss-cross method.

## AXLE AND DIFFERENTIAL (FRONT) (CONT'D)

### Drive Axle Assembly

Figure 40-20-147

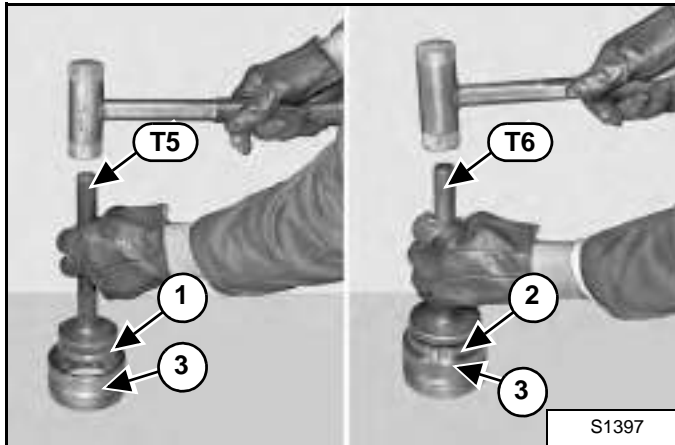

Using tools T5 and T6, insert the sealing ring (Item 1) and the bearing (Item 2) in the bush (Item 3) [Figure 40-20-147].

**NOTE:** Carefully check the assembly side of the sealing ring.

Figure 40-20-148

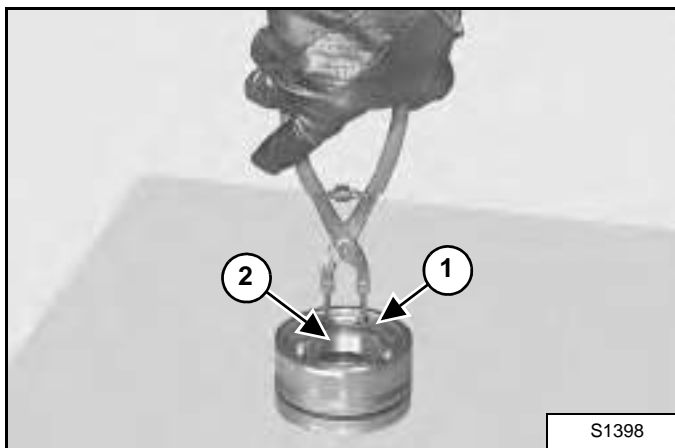

Fit the snap ring (Item 1) on the bearing (Item 2) [Figure 40-20-148].

Figure 40-20-149

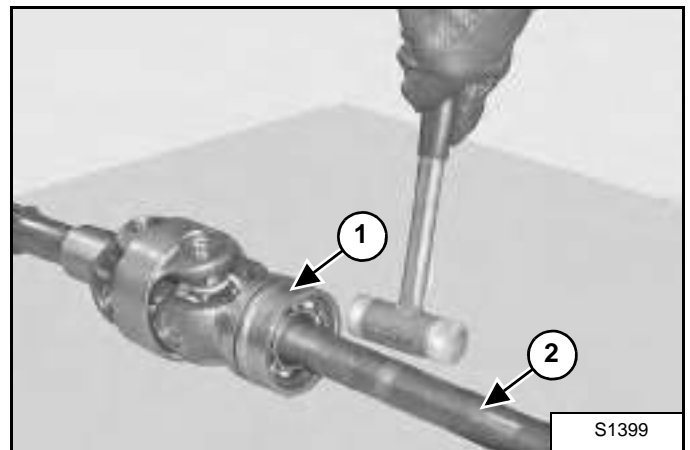

Heat the bush in oil at an approx. temperature of 100°C and fit the entire bush (Item 1) on the drive axle (Item 2) [Figure 40-20-149].

**! WARNING**

**AVOID BURN INJURY**

**Wear protective clothing when handling hot parts.**

Figure 40-20-150

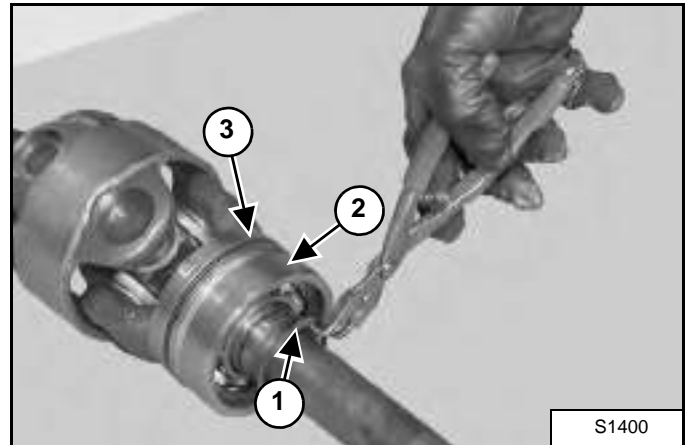

Install the snap ring (Item 1) on the axle shaft (Item 2). After the bearing has cooled, install the O-ring (Item 3) [Figure 40-20-150].



## AXLE AND DIFFERENTIAL (FRONT) (CONT'D)

### Drive Axle Assembly (Cont'd)

Figure 40-20-151

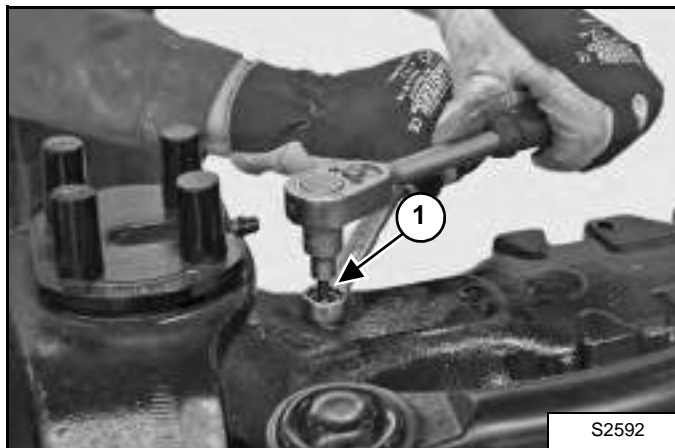

Insert the drive axle and tighten the top and bottom dowels (Item 1) [Figure 40-20-151]. Torque wrench setting: max. 11 ft.-lb. (15 N•m).

**NOTE:** Centre the point of the check dowels in the slot.

Figure 40-20-152

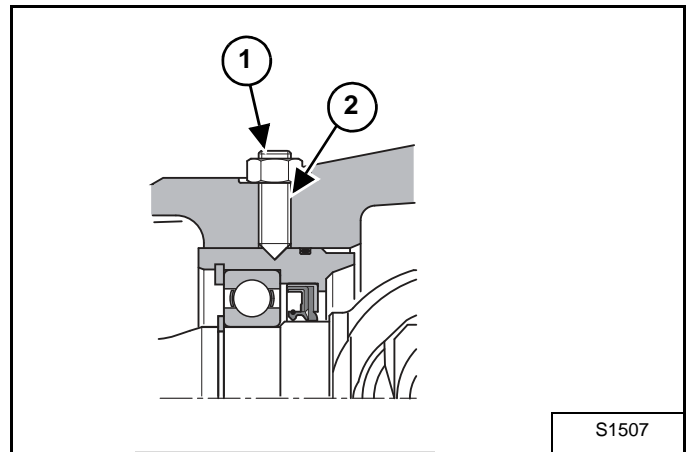

Screw the check nuts (Item 1) of the dowels (Item 2) [Figure 40-20-152] and lock them using a dynamometric wrench: 90 ft.-lb. (122 N•m).

## AXLE AND DIFFERENTIAL (FRONT) (CONT'D)

### Steering Knuckle Assembly

Figure 40-20-153

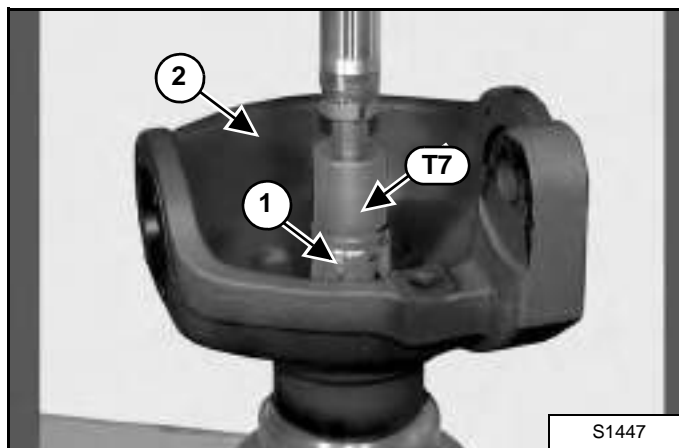

Lubricate the bushing (Item 1) and the seat of the steering case (Item 2). Install the bushing (Item 1) [Figure 40-20-153], using tool T7.

Figure 40-20-154

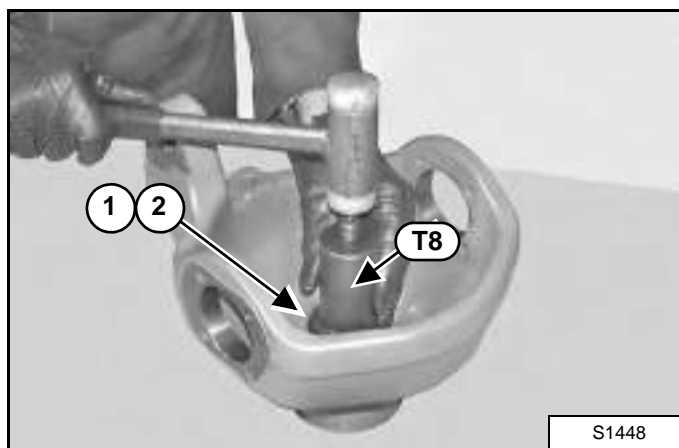

Lubricate the outer surface of the sealing ring (Item 1) and centering ring (Item 2) [Figure 40-20-154]. Fit them into their seat using tool T8.

Figure 40-20-155

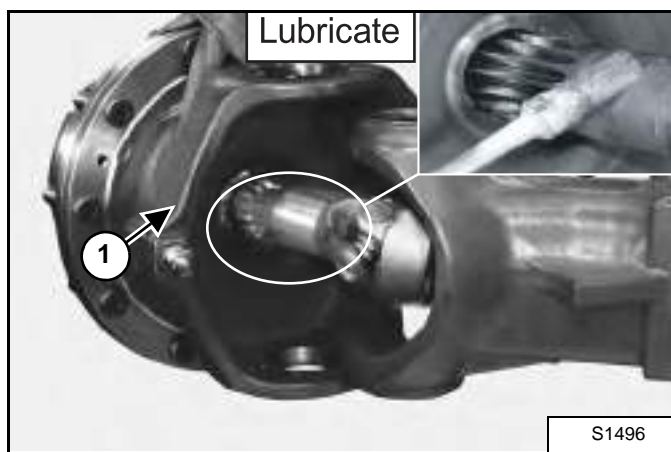

Lubricate the terminal of the drive axle and install the steering case (Item 1) [Figure 40-20-155]. Pay due attention not to damage the dust cover rings and the sealing rings.

Figure 40-20-156

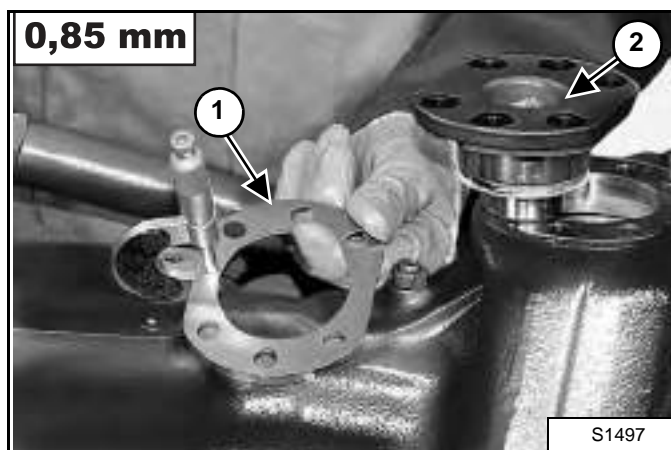

Prepare a series of shims (Item 1) of 0,85 mm. To be assembled under the upper pin (Item 2) [Figure 40-20-156].

## AXLE AND DIFFERENTIAL (FRONT) (CONT'D)

### Steering Knuckle Assembly (Cont'd)

Figure 40-20-157

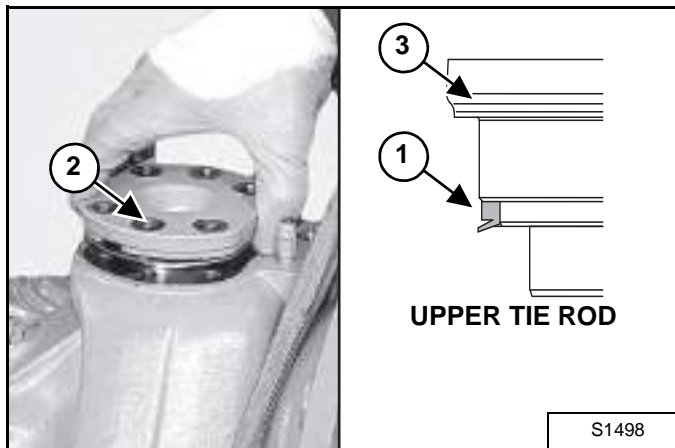

Install the seal (Item 1). Make sure the seal (Item 1) is orientated as shown in the inset. Lubricate the pivot pin (Item 3) and the seal (Item 1). Install the pivot pin (Item 3) and the six bolts (Item 2) [Figure 40-20-157]. (Bolts not shown in photo.) Tighten the bolts to 103 ft.-lb. (140 N•m) torque.

Figure 40-20-158

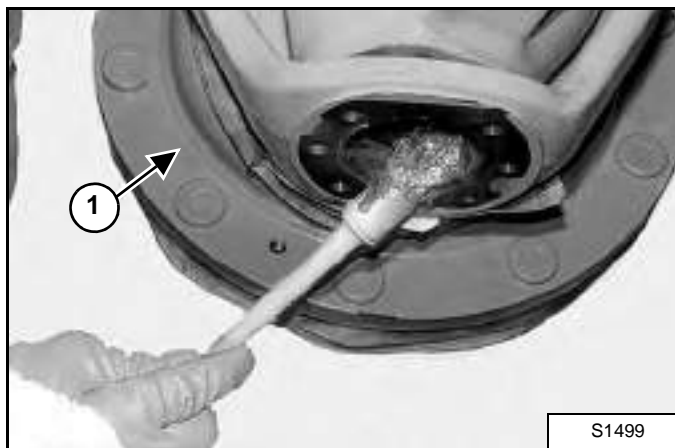

Lubricate the group with grease and mount it in the steering case (Item 1) [Figure 40-20-158].

Figure 40-20-159

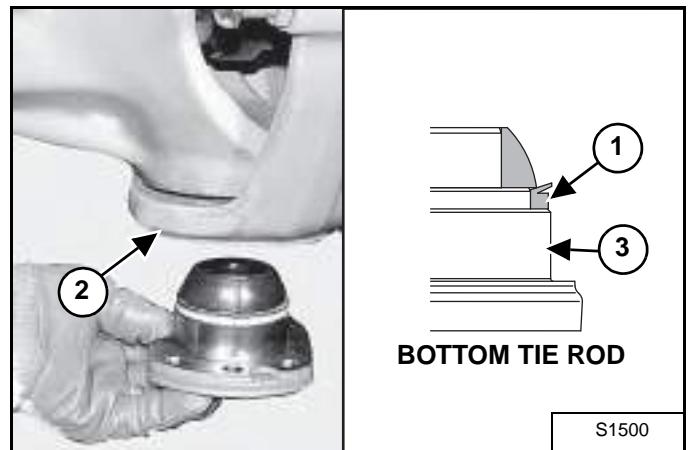

Install the seal (Item 1). Make sure the seal (Item 1) is orientated as shown in the inset. Lubricate the pivot pin (Item 3) and the seal (Item 1). Install the pivot pin (Item 3) and the six bolts (Item 2) [Figure 40-20-159]. (Bolts not shown in photo.) Tighten the bolts to 103 ft.-lb. (140 N•m) torque.

Figure 40-20-160

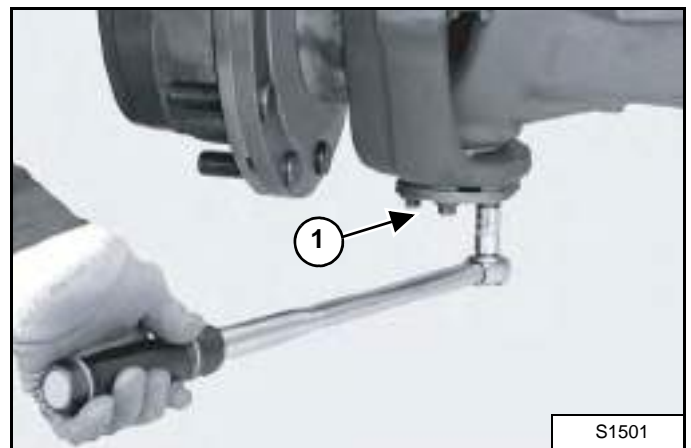

Tighten the fitting screws (Item 1) [Figure 40-20-160] of the bottom tie rod in sequence using the cross tightening method, apply a torque of 103 ft.-lb. (140 N•m).

## AXLE AND DIFFERENTIAL (FRONT) (CONT'D)T'D)

### Steering Knuckle Assembly (Cont'd)

Figure 40-20-161

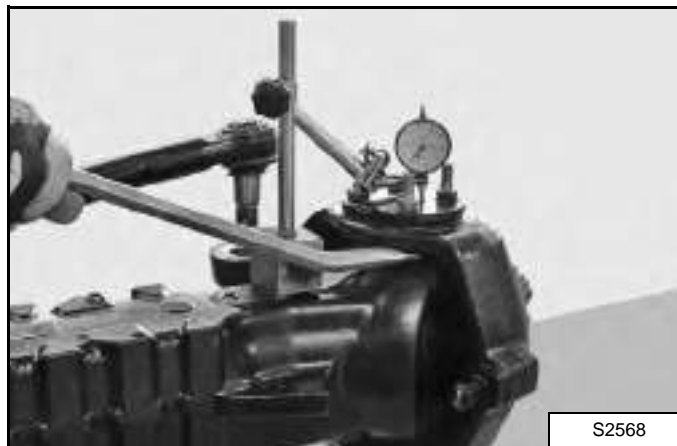

Install a magnetic based dial indicator on the steering housing. Check by means of a lever that there is no vertical gap. In case there is any gap, determine the width and reduce it by removing shims [Figure 40-20-161].

Figure 40-20-162



Check the torque of the pins, which has to be between 30 and 44 ft.-lb. (60 N•m). If the preliminary measured value is too high, the shims have to be increased [Figure 40-20-162].

## AXLE AND DIFFERENTIAL (FRONT) (CONT'D)

### Planetary carrier Assembly

Figure 40-20-163

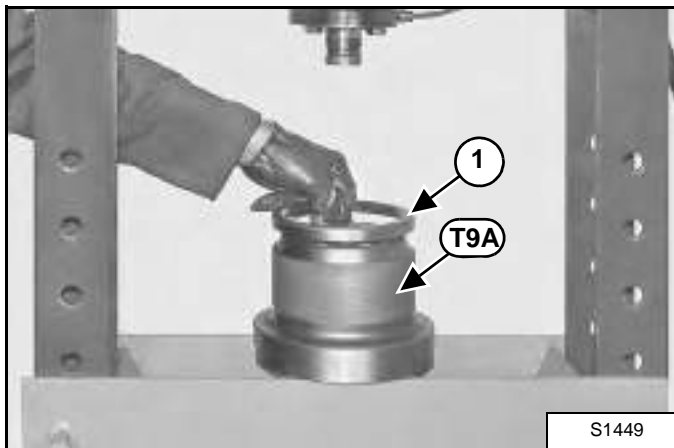

Position the lower part of tool **T9A** and the bearing race of the external bearing (Item 1) [Figure 40-20-163] under the press.

Figure 40-20-164

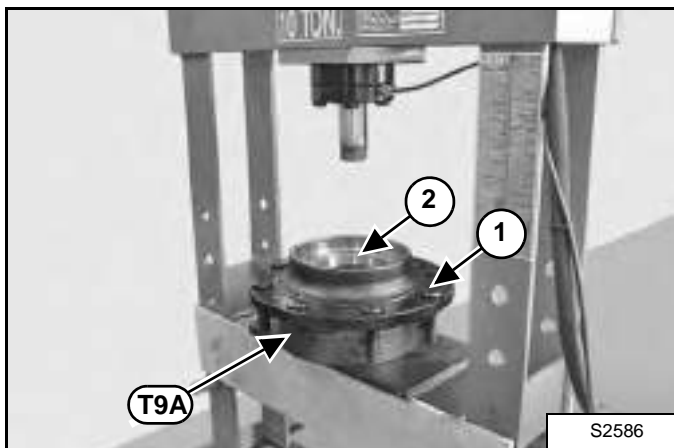

Lubricate the seats of the bearings and position the hub (Item 1) on tool **T9A**. Position the bearing race (Item 2) [Figure 40-20-164] (wide side up).

**NOTE:** Check that the bearing race is correctly oriented.

Figure 40-20-165

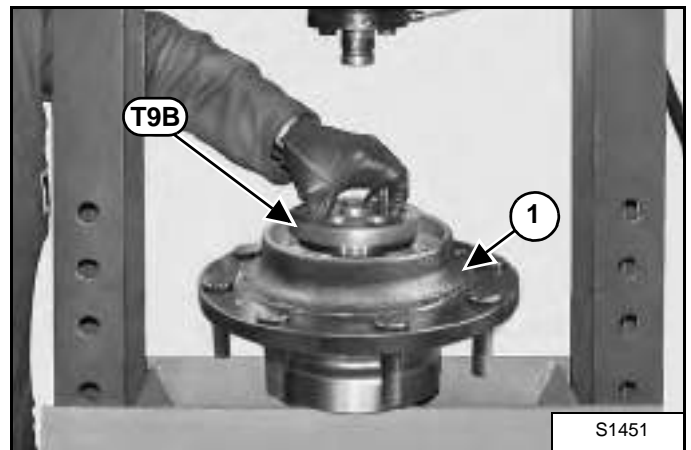

Position the upper part of tool **T9B** and press the bearing races into the hub (Item 1) [Figure 40-20-165] all the way down.

Figure 40-20-166



Fit the bearing (Item 1) [Figure 40-20-166] into the bearing race.

## AXLE AND DIFFERENTIAL (FRONT) (CONT'D)

### Planetary carrier Assembly (Cont'd)

Figure 40-20-167

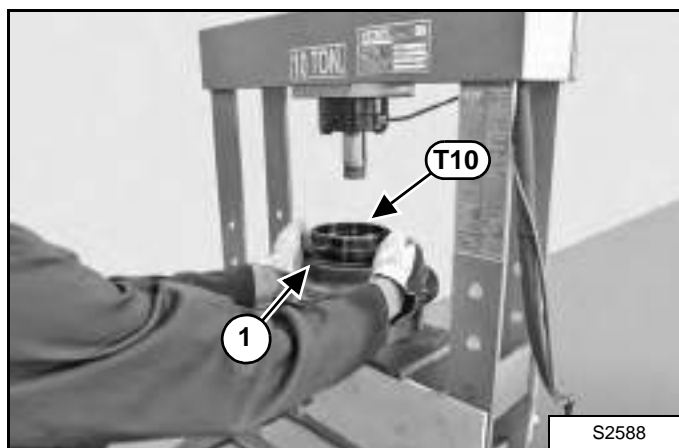

Position tool **T10** and press the sealing ring (Item 1) [Figure 40-20-167] into its seat.

Figure 40-20-168



Insert the flange (Item 1) in the crown (Item 2) [Figure 40-20-168].

Figure 40-20-169

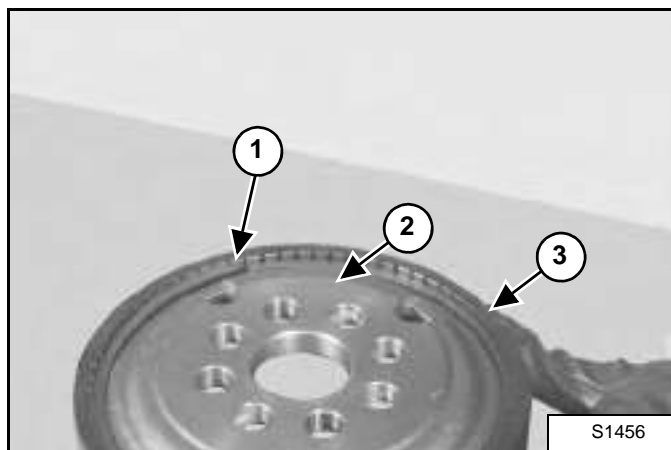

Insert the snap ring (Item 1) in order to fix the flange (Item 2) in the crown (Item 3) [Figure 40-20-169].

**NOTE:** Make sure the snap ring is firmly seated in the groove.

Figure 40-20-170

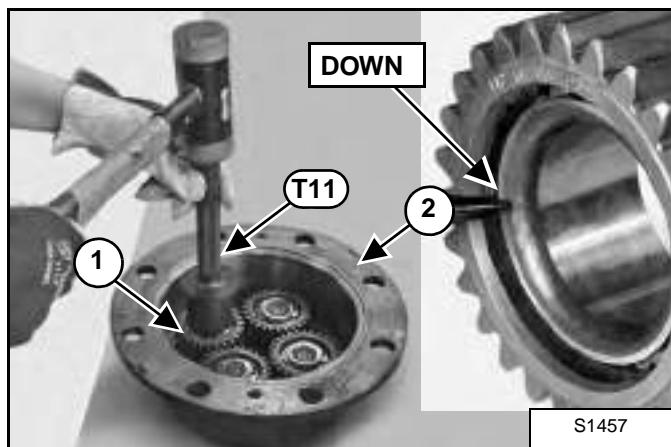

With the help of tool **T11**, insert the planet wheel gears (Item 1) into the cover (Item 2) [Figure 40-20-170]. Accurately check the orientation.

## AXLE AND DIFFERENTIAL (FRONT) (CONT'D)

### Planetary carrier Assembly (Cont'd)

Figure 40-20-171

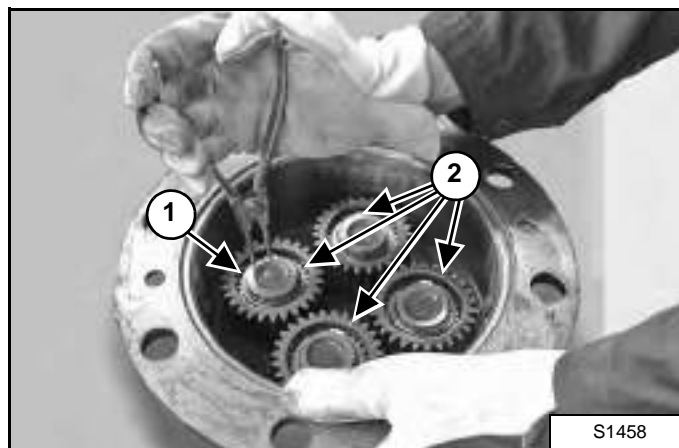

Install the four snap rings (Item 1) [Figure 40-20-171].

Figure 40-20-172

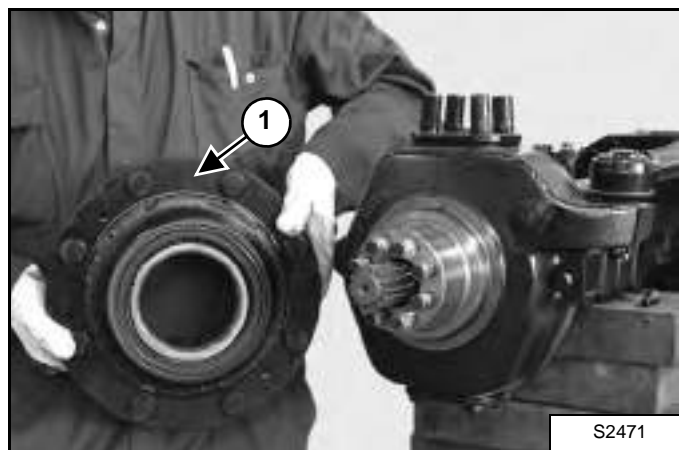

Install the hub (Item 1) [Figure 40-20-172].

Figure 40-20-173

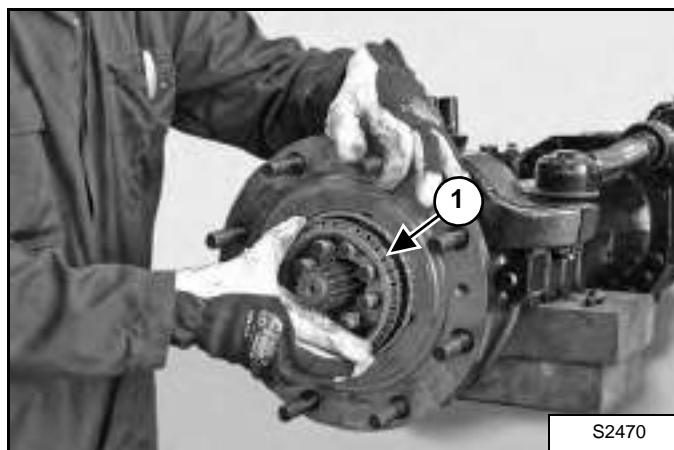

Install the external bearing (Item 1) [Figure 40-20-173].

**NOTE:** Using a plastic hammer, drive the bearing to the limit stop by lightly hammering around the edge.

## AXLE AND DIFFERENTIAL (FRONT) (CONT'D)

### Planetary carrier Assembly (Cont'd)

Figure 40-20-174

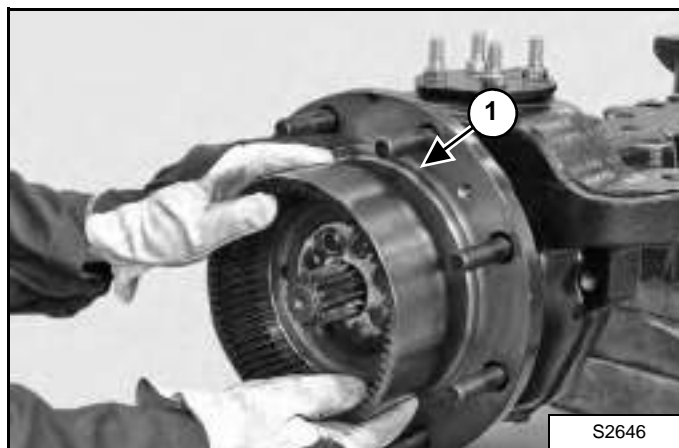

Fit the complete crown flange (Item 1) [Figure 40-20-174].

**NOTE:** In order to fasten the flange, use a plastic hammer and alternatively hammer on several equidistant points.

Figure 40-20-175

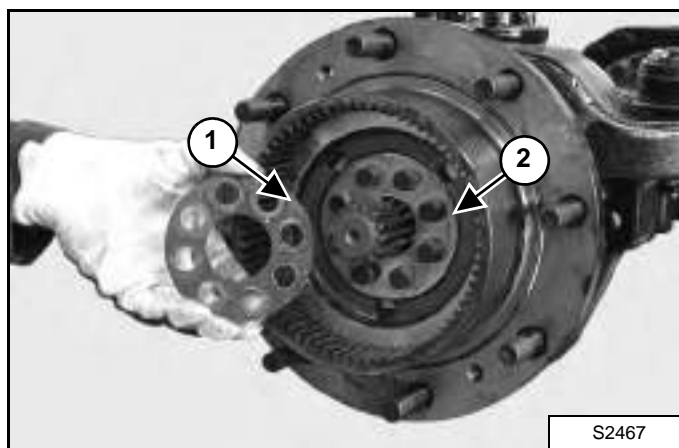

Apply silicone-based grease to the surface of the flange (Item 1) which touches the crown flange (Item 2) [Figure 40-20-175].

Fit the flange (Item 1) [Figure 40-20-175].

Figure 40-20-176

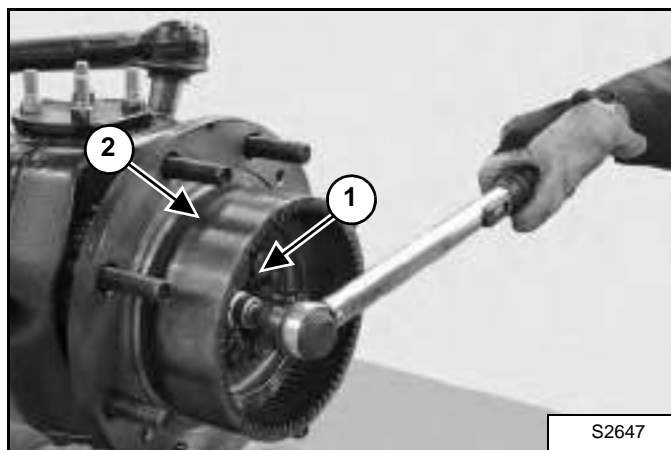

Apply silicone based grease to the surface of the flange (Item 1) which touches the crown flange (Item 2) [Figure 40-20-176].

Cross tighten the nuts (Item 1) [Figure 40-20-176] in two stages.

Initial torque wrench setting: 89 ft.-lb. (120 N•m).  
Final torque wrench setting: 188 - 210 ft.-lb. (255 - 285 N•m).

Figure 40-20-177

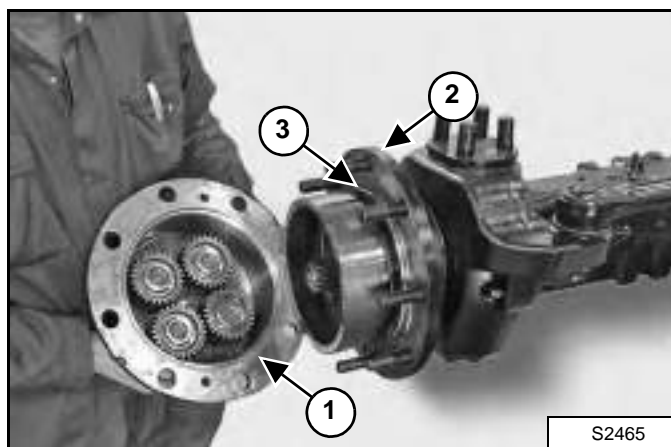

Fit the planetary carrier cover (Item 1) onto the hub (Item 2) [Figure 40-20-177].

**NOTE:** Check that the O-ring (Item 3) [Figure 40-20-177] is in good condition and in position.



---

## AXLE AND DIFFERENTIAL (FRONT) (CONT'D)

### Planetary carrier Assembly (Cont'd)

Figure 40-20-178

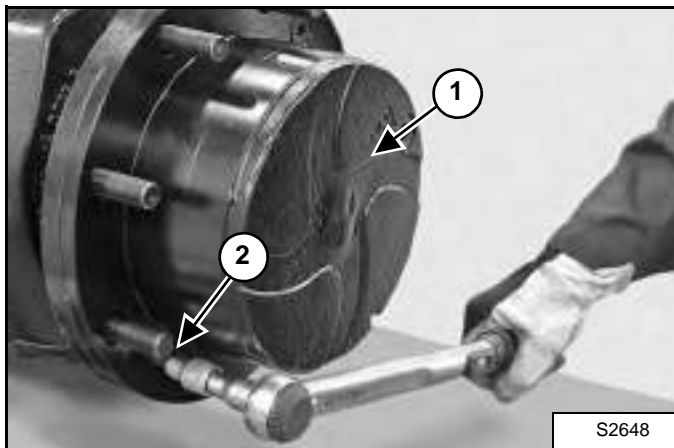

Lock the planetary carrier cover (Item 1) by tightening the screws (Item 2) **[Figure 40-20-178]**. Apply a torque of 30 - 37 ft.-lb. (40 - 50 N•m).

## AXLE AND DIFFERENTIAL (FRONT) (CONT'D)

### Special Tools

BOBCAT PN	IMAGE	DESCRIPTION	TOOL NR.
6912190		WHEEL HUB SEAL	T10
6912192		DIFFERENTIAL RING NUT	T13
6912196		DIFFERENTIAL BEARING INNER RINGS	T17
6912197		PINION RING NUT	T19 T21 T22
6912199		PINION DUMMY BEARING	T24
6912201		DUMMY PINION	T26
6912202		PINION TAIL SEAL	T27

## AXLE AND DIFFERENTIAL (REAR)

### General Information

For photo clarity, the following axle procedures are done with the complete axle assembly removed from the machine, although the planetary carrier, wheel hub, steering knuckle and drive axle procedures may be done with the axle assembly installed in the machine. For complete axle repair, the following must be done.

- Rear Axle removal. (See “Removal” on page 40-90-1.)
- Rear steering cylinder removal. (See “Removing the Steering Cylinder” on page 20-61-1.)

### Planetary Carrier Parts Identification

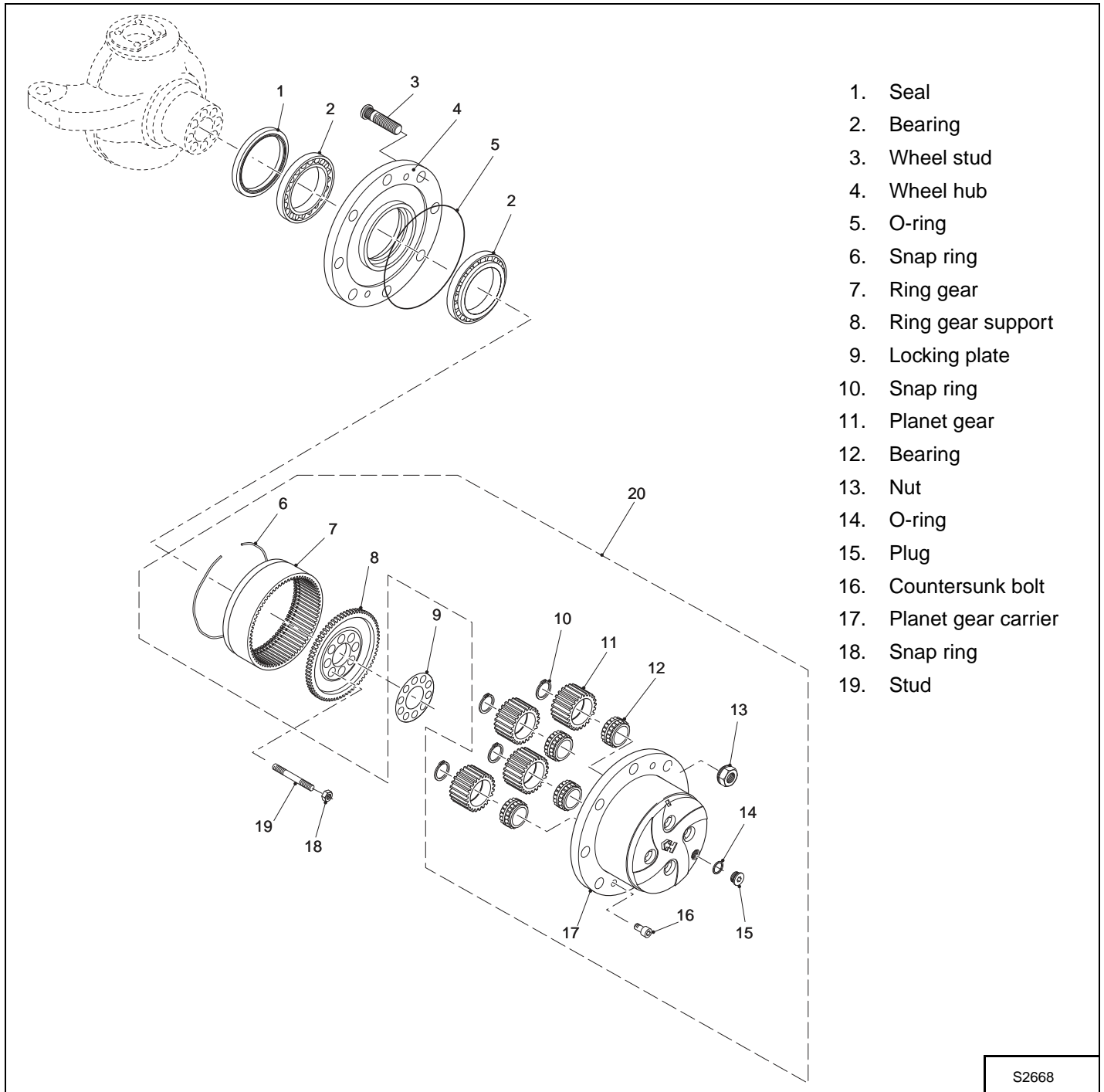

## AXLE AND DIFFERENTIAL (REAR) (CONT'D)

### Planetary Carrier Disassembly (Cont'd)

Figure 40-21-1

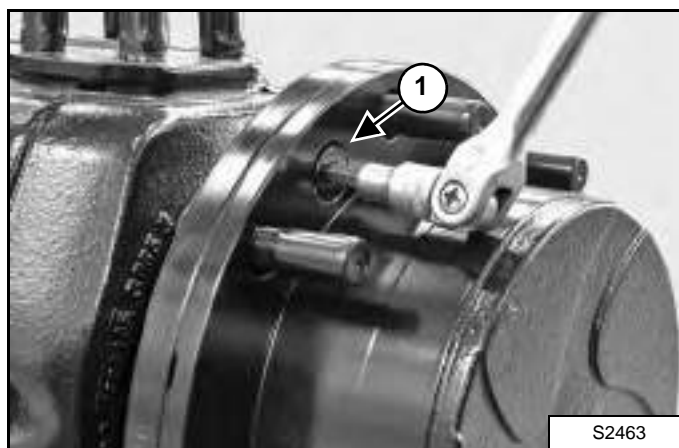

Loosen the securing bolts (Item 1) [Figure 40-21-1] only so that later when you pry the planet gear carrier loose, it does not fall.

Figure 40-21-2

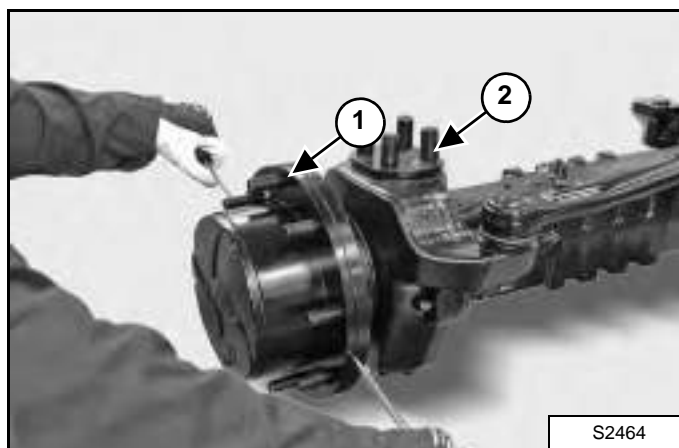

Remove the planet gear carrier (Item 1) from the steering case (Item 2) [Figure 40-21-2] by alternatively forcing a screwdriver into the appropriate slots.

Figure 40-21-3

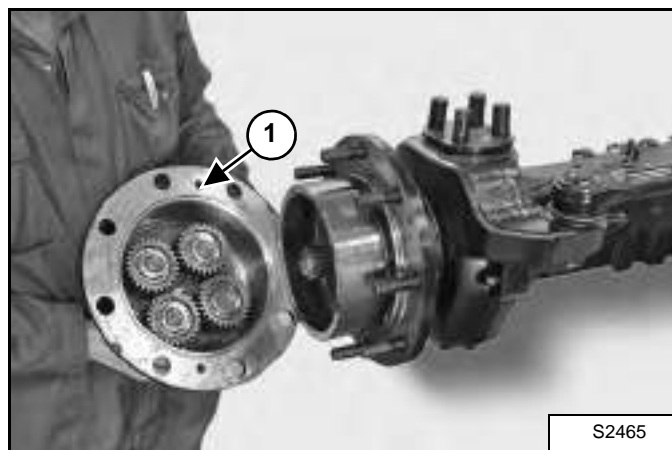

Remove the securing bolts and lift the planet gear carrier (Item 1) [Figure 40-21-3].

Figure 40-21-4

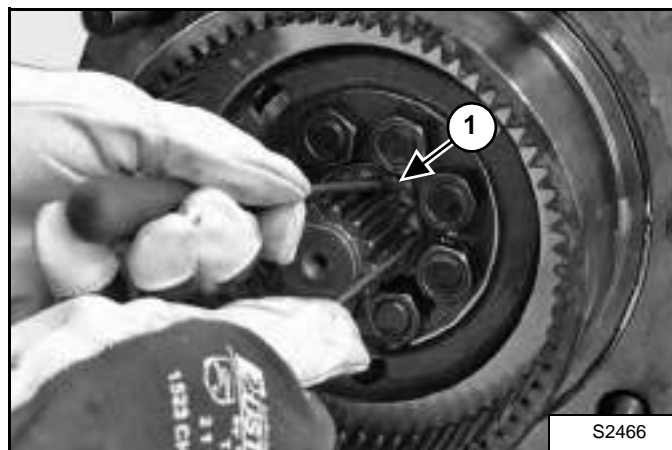

Remove the snap ring (Item 1) [Figure 40-21-4].

## AXLE AND DIFFERENTIAL (REAR) (CONT'D)

### Planetary Carrier Disassembly (Cont'd)

Figure 40-21-5

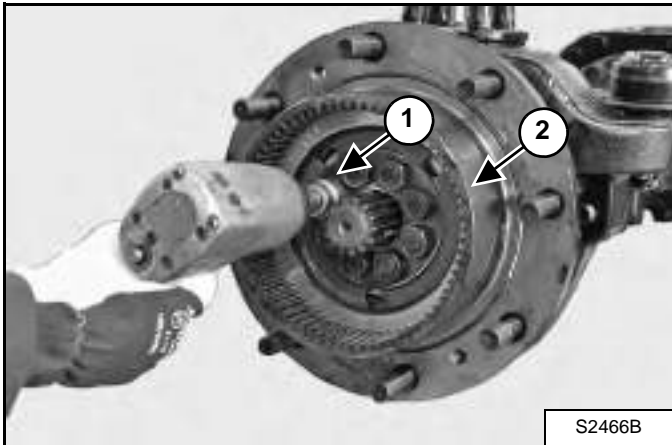

Remove the nuts (Item 1) from the ring gear support (Item 2) [Figure 40-21-5].

Figure 40-21-6

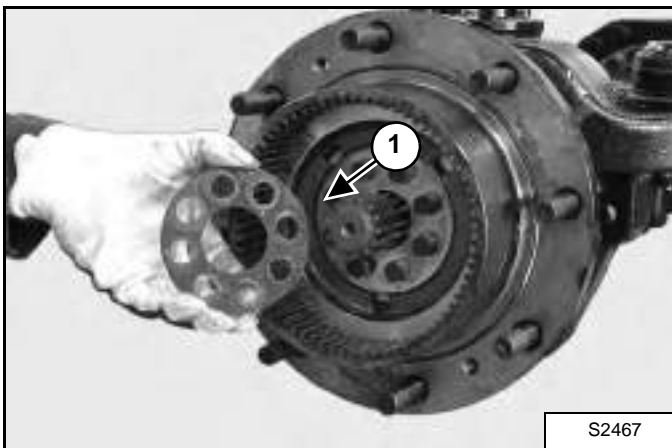

Remove the locking plate (Item 1) [Figure 40-21-6].

Figure 40-21-7

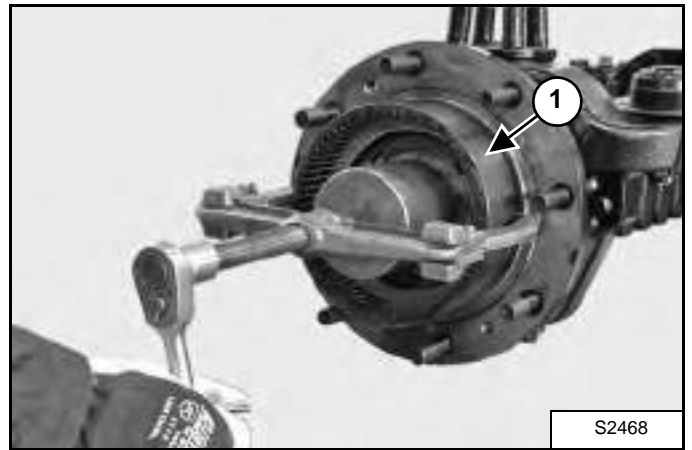

Using a puller, remove the complete ring gear (Item 1) [Figure 40-21-7] by acting on the stud bolts.

Figure 40-21-8

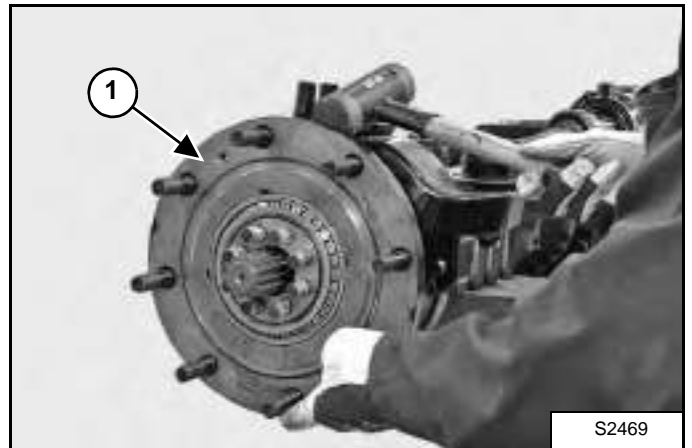

Partially extract the wheel hub (Item 1) [Figure 40-21-8] using a plastic hammer.

**NOTE: Alternately hammer on several equidistant points.**

## AXLE AND DIFFERENTIAL (REAR) (CONT'D)

### Planetary Carrier Disassembly (Cont'd)

Figure 40-21-9

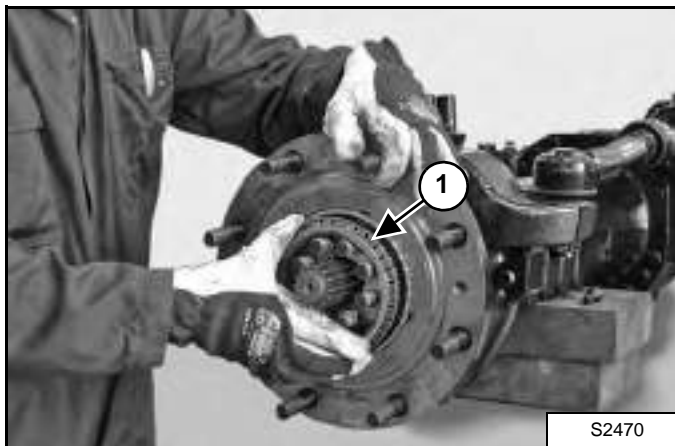

Remove the external bearing (Item 1) [Figure 40-21-9].

Figure 40-21-10

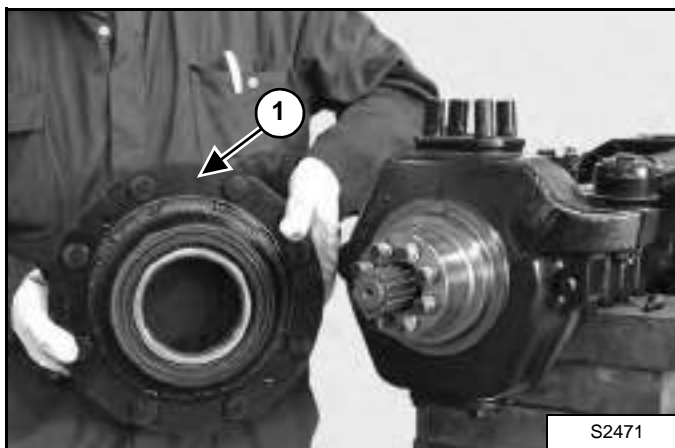

Remove the complete wheel hub (Item 1) [Figure 40-21-10] by hand.

Figure 40-21-11

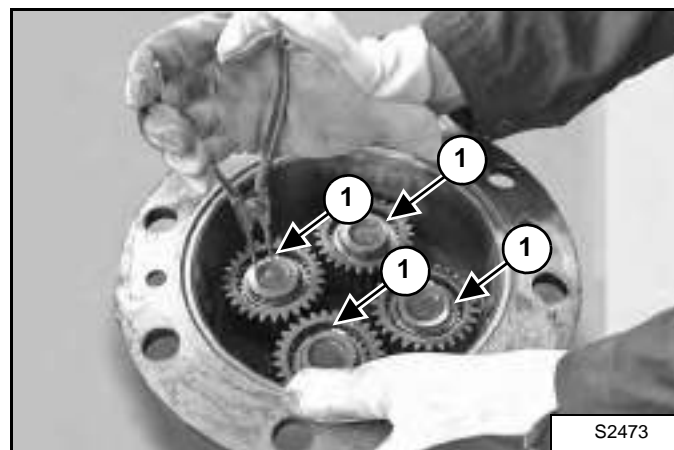

Remove the snap rings (Item 1) [Figure 40-21-11].

Figure 40-21-12

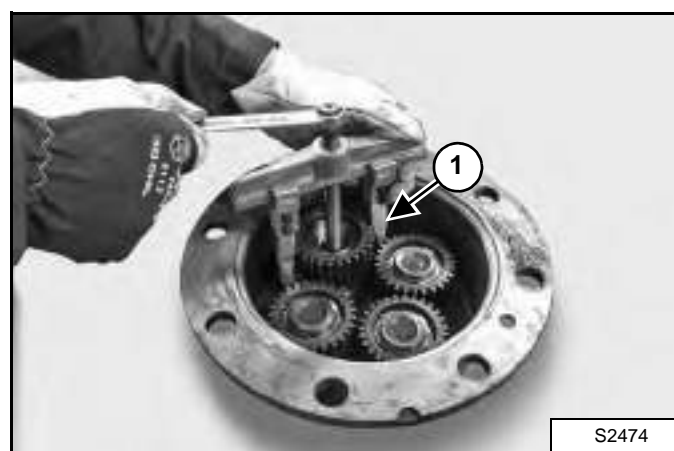

With the help of a puller, remove the planet wheel gears (Item 1) [Figure 40-21-12].

**NOTE:** Note the assembly side of the planet wheels.

**AXLE AND DIFFERENTIAL (REAR) (CONT'D)**

**Planetary Carrier Disassembly (Cont'd)**

**Figure 40-21-13**

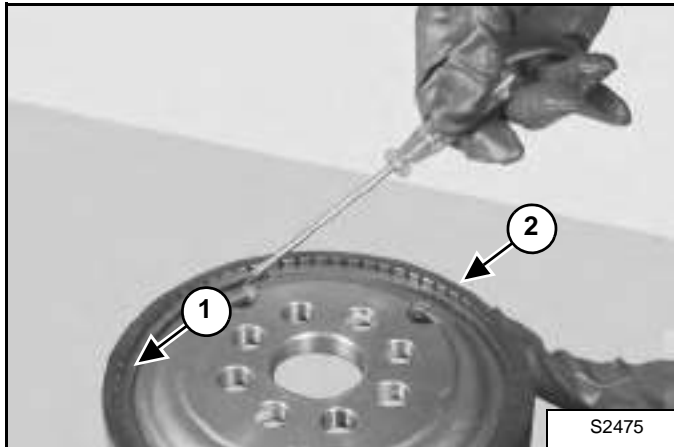

Remove the snap ring (Item 1) from the ring gear (Item 2) [Figure 40-21-13].

**Figure 40-21-14**



Remove the ring gear support (Item 1) [Figure 40-21-14].

**Figure 40-21-15**

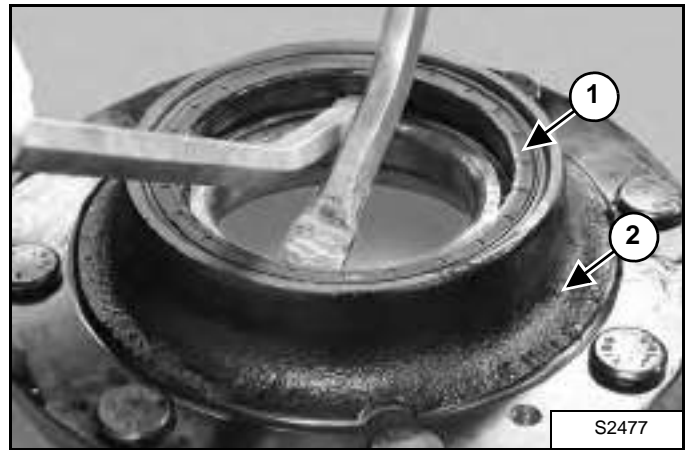

Remove the sealing ring (Item 1) from the wheel hub (Item 2) [Figure 40-21-15].

**Figure 40-21-16**

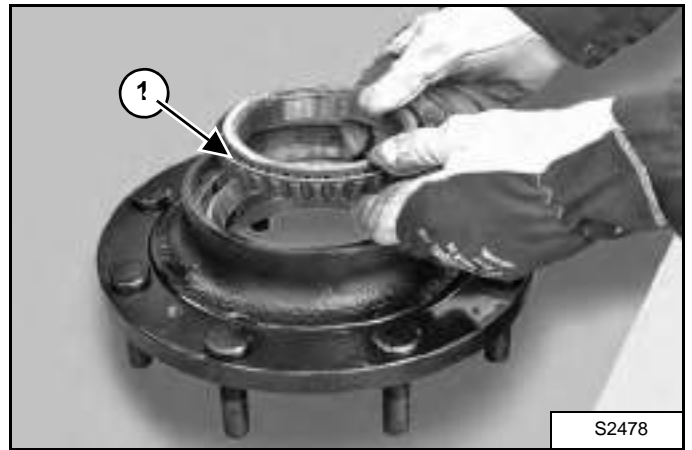

Remove the internal bearing (Item 1) [Figure 40-21-16].

---

## AXLE AND DIFFERENTIAL (REAR) (CONT'D)

### Planetary Carrier Disassembly (Cont'd)

Figure 40-21-17



Remove the external bearing races from the bearing forcing a pin-driver into the appropriate slots on the hub (Item 1) [Figure 40-21-17].

**NOTE:** Hammer in an alternate way so as to avoid crawling or deformation of the bearing races.



# AXLE AND DIFFERENTIAL (REAR) (CONT'D)

## Steering Knuckle and Drive Axle Parts Identification

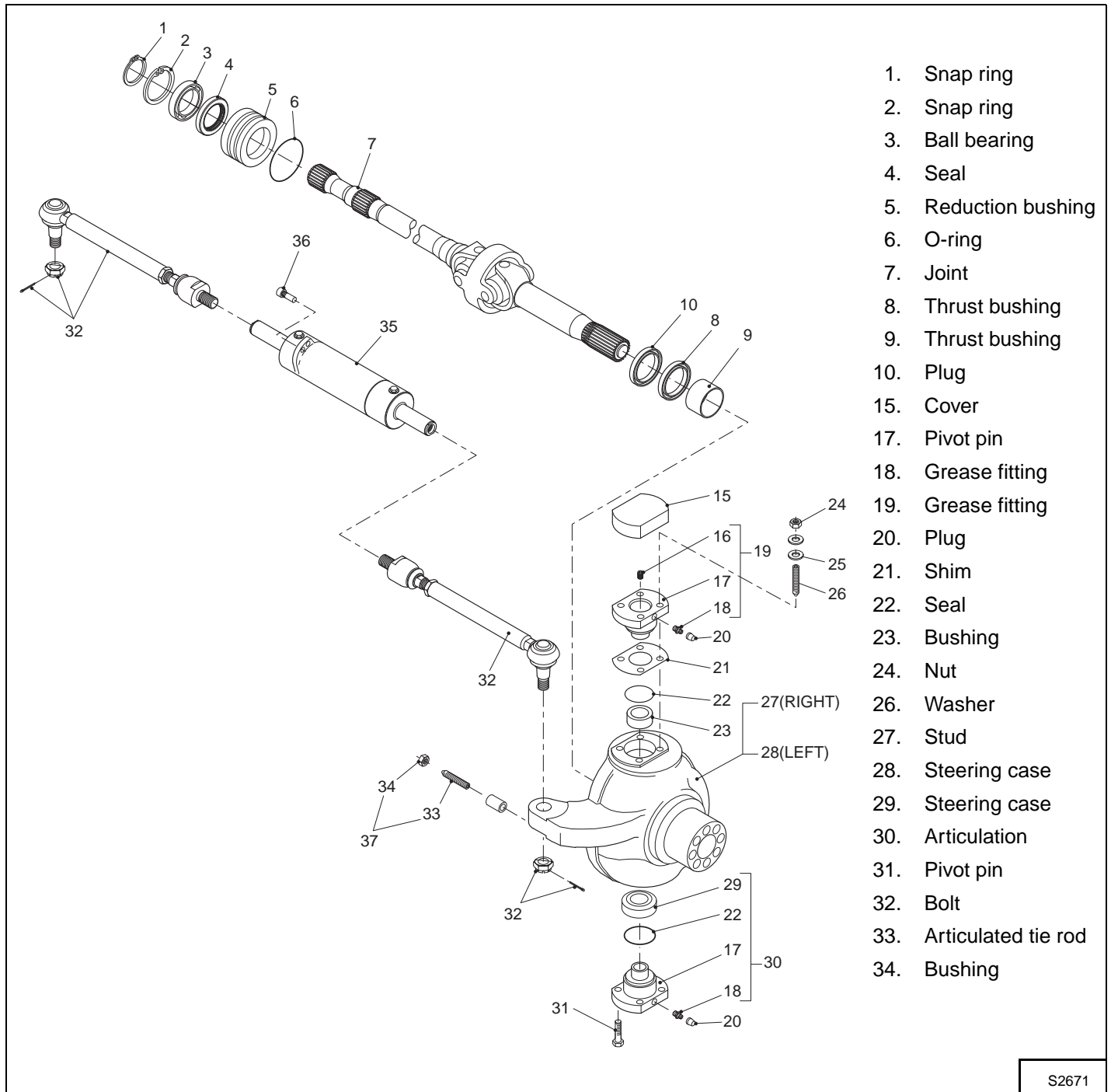

1. Snap ring
2. Snap ring
3. Ball bearing
4. Seal
5. Reduction bushing
6. O-ring
7. Joint
8. Thrust bushing
9. Thrust bushing
10. Plug
15. Cover
17. Pivot pin
18. Grease fitting
19. Grease fitting
20. Plug
21. Shim
22. Seal
23. Bushing
24. Nut
26. Washer
27. Stud
- 27(RIGHT)
- 28(LEFT)
28. Steering case
29. Steering case
30. Articulation
31. Pivot pin
32. Bolt
33. Articulated tie rod
34. Bushing

S2671

## AXLE AND DIFFERENTIAL (REAR) (CONT'D)

### Steering Knuckle Disassembly

Figure 40-21-18

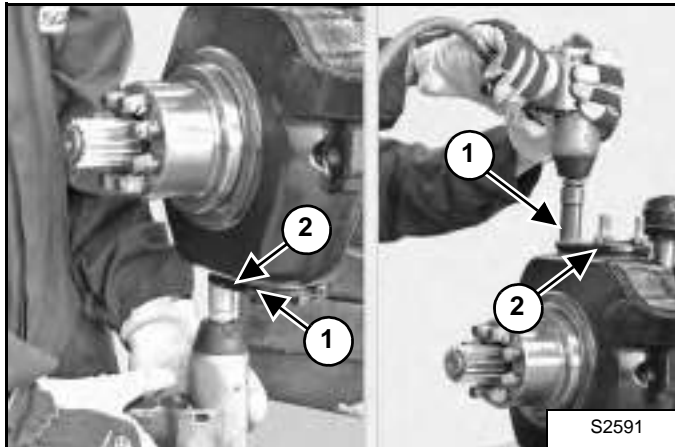

Loosen and remove the fitting screws (Item 1) from the tie rod (Item 2) [Figure 40-21-18].

Figure 40-21-19



Using two levers, remove the bottom tie rod (Item 1) complete with front sealing ring (Item 2) [Figure 40-21-19].

Figure 40-21-20

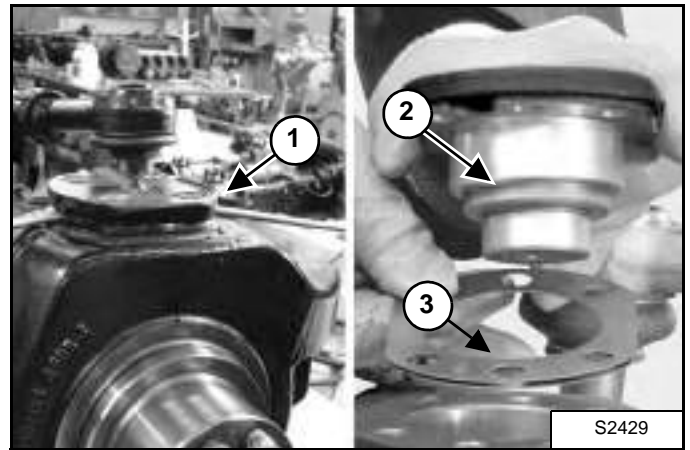

Using two levers, remove the top tie rod (Item 1) complete with front seal (Item 2) and shims (Item 3) [Figure 40-21-20].

Figure 40-21-21

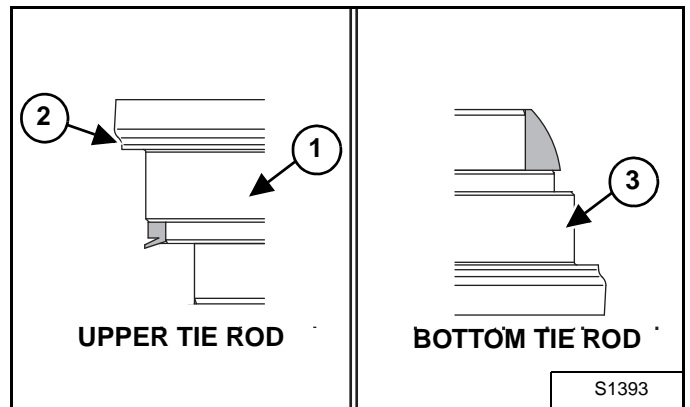

Configuration of the upper (Item 1) tie rod with shims (Item 2) and the lower tie rod (Item 3) [Figure 40-21-21].

## AXLE AND DIFFERENTIAL (REAR) (CONT'D)

### Steering Knuckle Disassembly (cont'd)

Figure 40-21-22

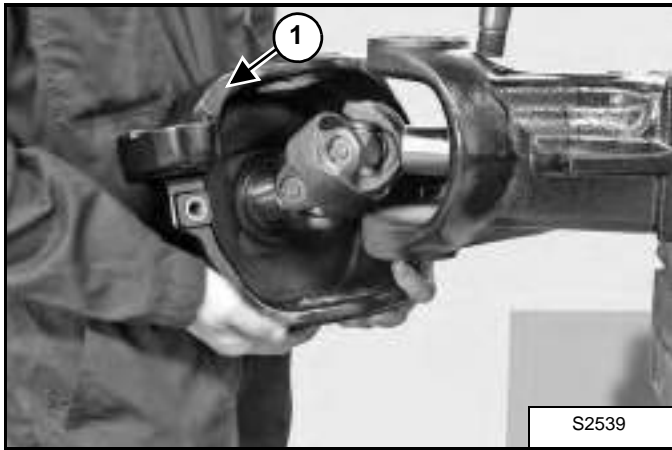

Remove the complete steering case (Item 1) [Figure 40-21-22].

Figure 40-21-23

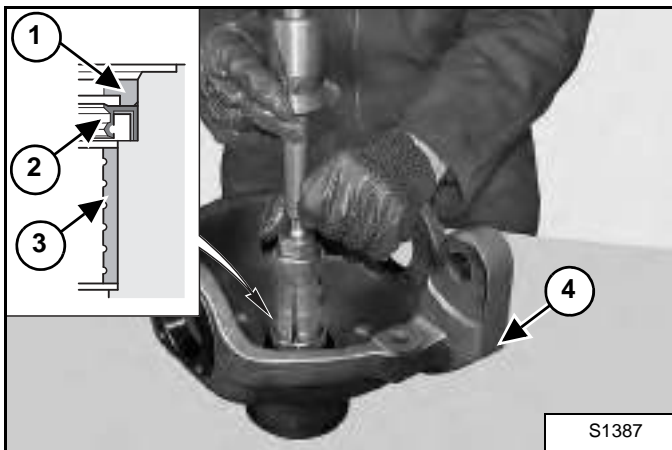

Use a puller to remove the centring ring (Item 1), the sealing ring (Item 2) and the bearing (Item 3) from the steering case (Item 4) [Figure 40-21-23].

**NOTE:** Note down the orientation of both centring and sealing ring.

Figure 40-21-24

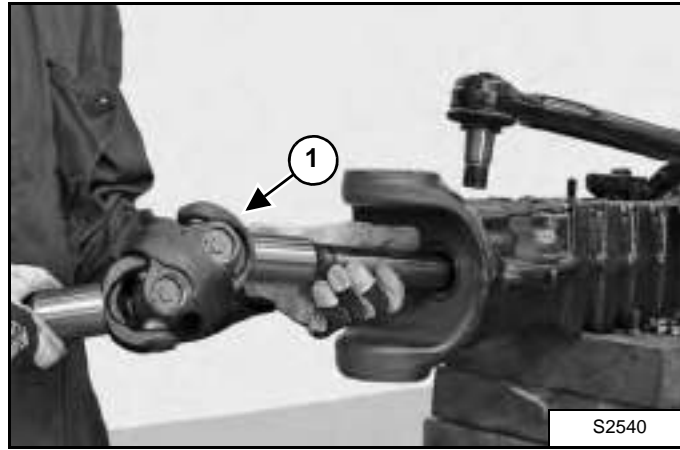

Remove the entire drive axle (Item 1) [Figure 40-21-24].

**NOTE:** To remove the drive axle use, if necessary, a plastic hammer or a lever.

# AXLE AND DIFFERENTIAL (REAR) (CONT'D)

## Differential and Bevel Pinion Parts Identification

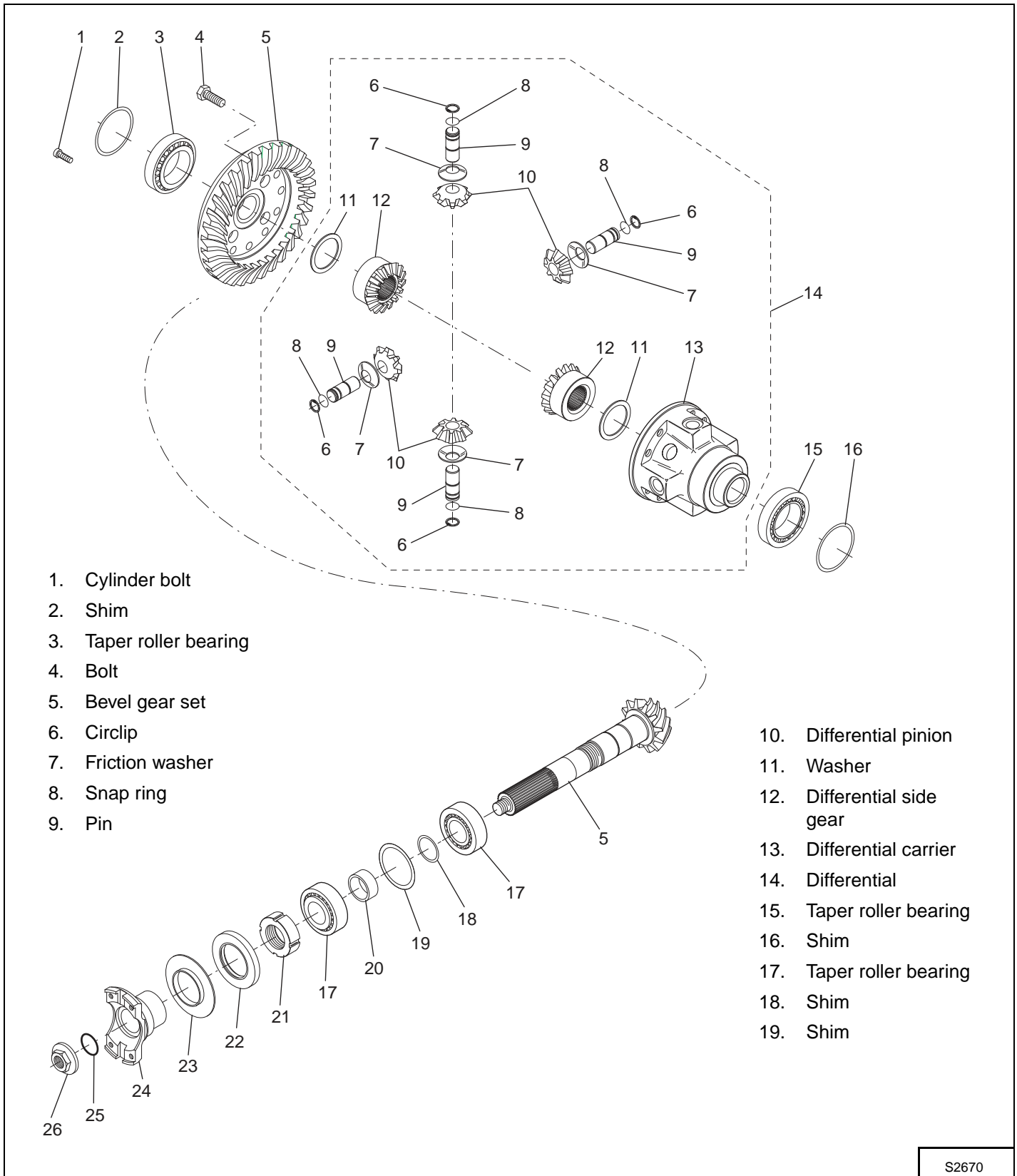

S2670

## AXLE AND DIFFERENTIAL (REAR) (CONT'D)

### Differential Disassembly

Figure 40-21-25

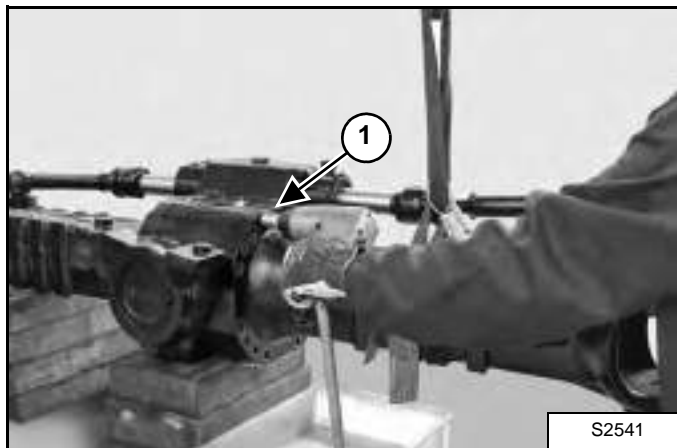

Loosen the nuts (Item 1) [Figure 40-21-25].

Figure 40-21-26

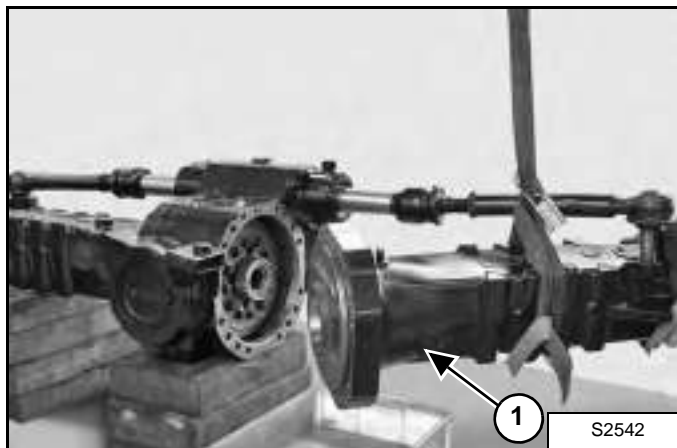

Remove the complete arm (Item 1) [Figure 40-21-26].

Figure 40-21-27



Pull out the differential (Item 1) [Figure 40-21-27].

Figure 40-21-28

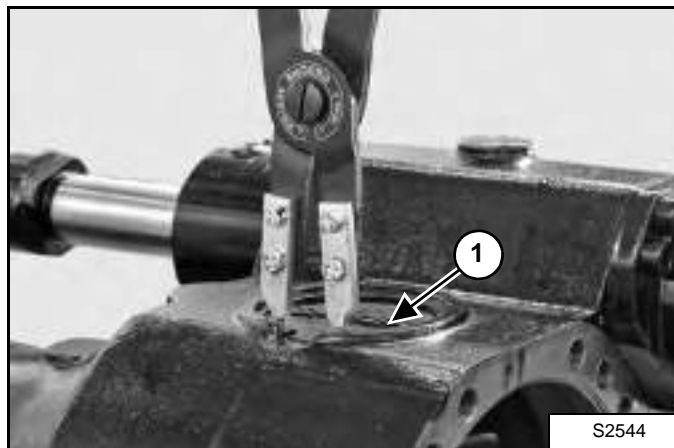

Remove the snap ring (Item 1) [Figure 40-21-28].

## AXLE AND DIFFERENTIAL (REAR) (CONT'D)

### Differential Disassembly (Cont'd)

Figure 40-21-29

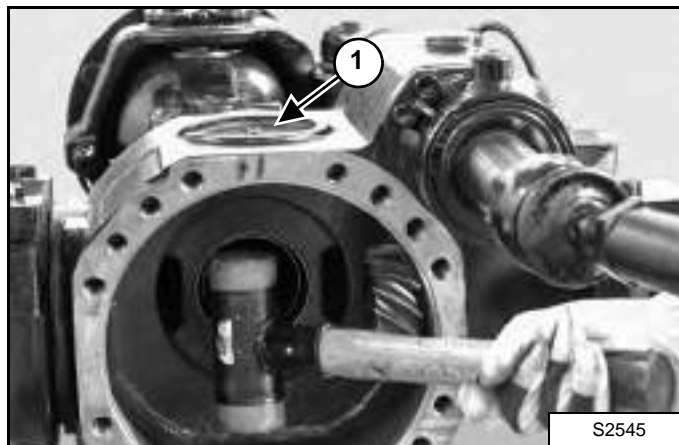

Remove the top plug (Item 1) [Figure 40-21-29].

Figure 40-21-30

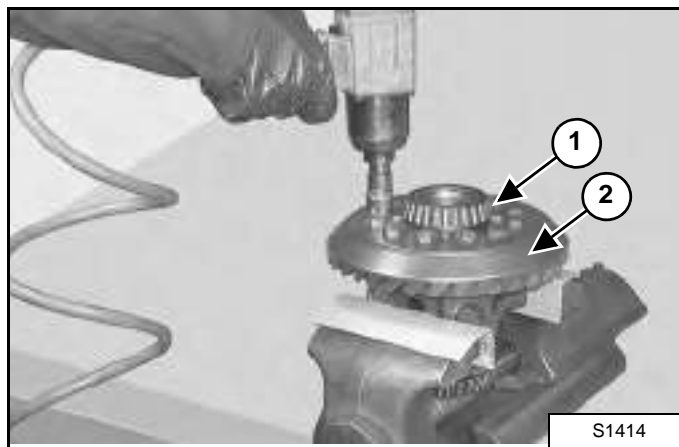

Remove the fitting screws (Item 1) from the crown (Item 2) [Figure 40-21-30].

Figure 40-21-31

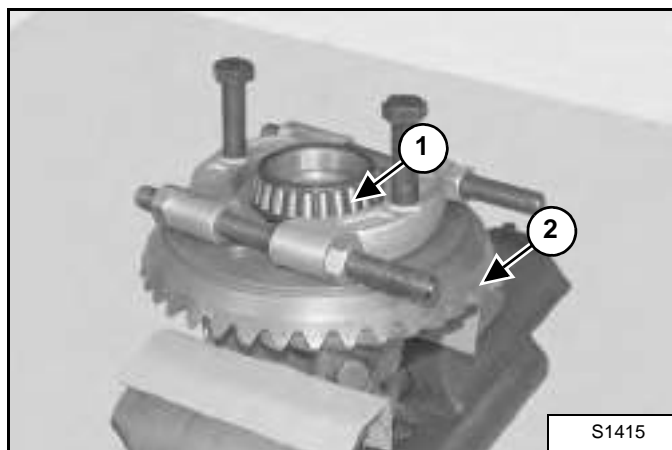

If the bearing needs to be replaced, extract the bearing (Item 1) and remove the crown (Item 2) [Figure 40-21-31].

Figure 40-21-32

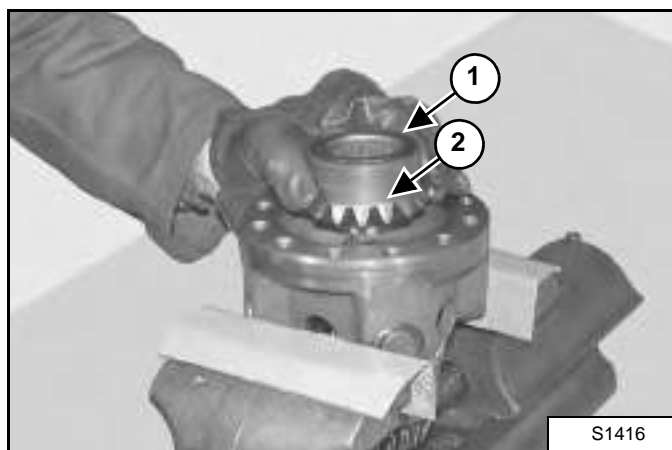

Remove the shim washer (Item 1) and the planetary gear (Item 2) [Figure 40-21-32].

## AXLE AND DIFFERENTIAL (REAR) (CONT'D)

### Differential Disassembly (Cont'd)

Figure 40-21-33

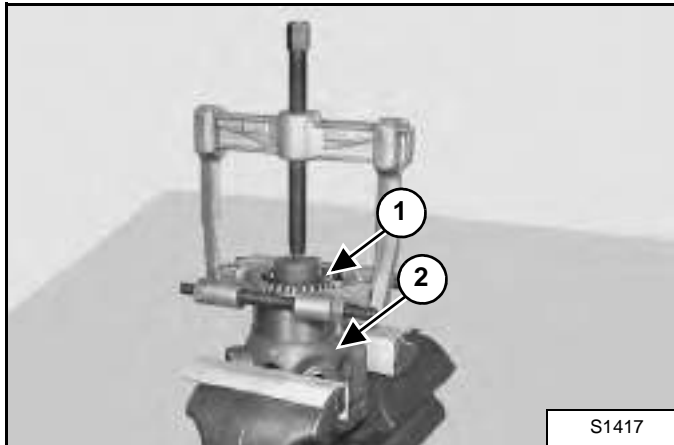

If the bearing needs to be replaced, extract the bearing (Item 1) from the differential carrier (Item 2) [Figure 40-21-33].

Figure 40-21-34

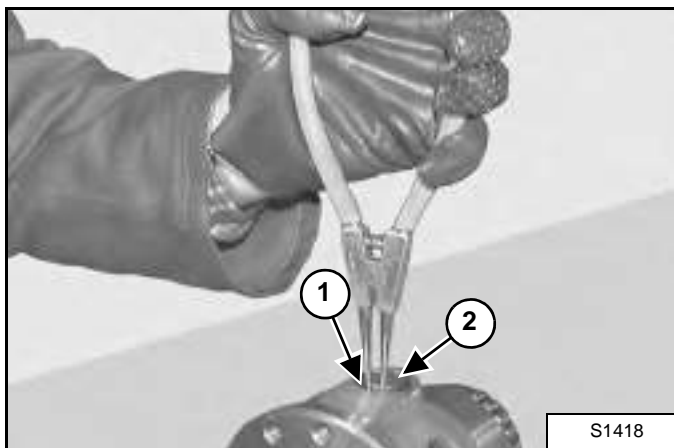

Remove the snap rings (Item 1) from the four pins (Item 2) [Figure 40-21-34] of the planet wheel gears.

Figure 40-21-35

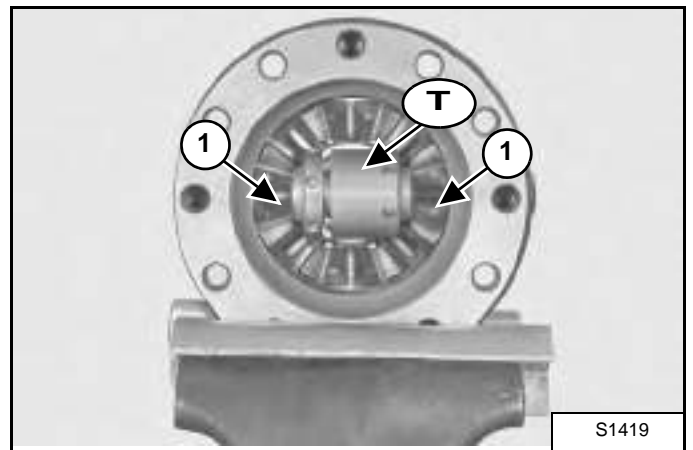

Insert a tool T between two planet wheel gears (Item 1) [Figure 40-21-35].

**NOTE:** Make sure that the tool is perfectly lined up with the pins (Item 1) [Figure 40-21-35] when locked.

Figure 40-21-36

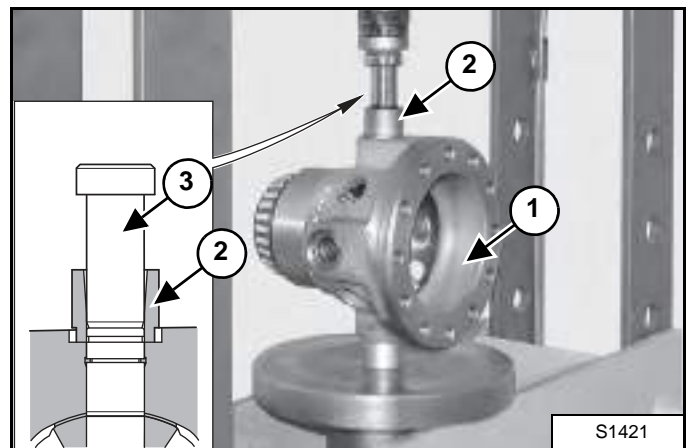

Place the differential carrier (Item 1) under a press, position a bushing (Item 2) and insert a pin (Item 3) [Figure 40-21-36]. Press the pin of the upper planet wheel gear into the tool T [Figure 40-21-35].

## AXLE AND DIFFERENTIAL (REAR) (CONT'D)

### Differential Disassembly (Cont'd)

Figure 40-21-37

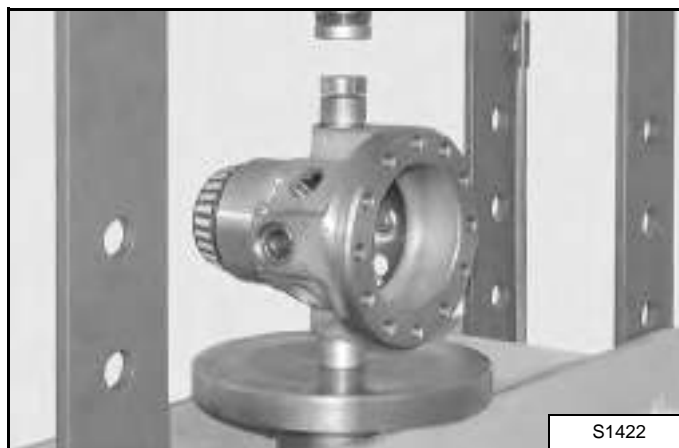

Remove the pin and bushing [Figure 40-21-37].

**NOTE:** In this condition the tool contains the pin.

Figure 40-21-38



Remove the tool with inside the pin of the planet wheel gear [Figure 40-21-38].

Figure 40-21-39

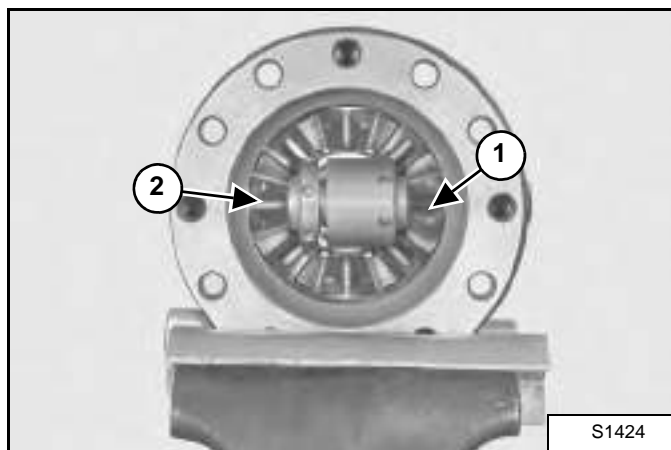

Leave the released planet wheel gear (Item 1) [Figure 40-21-39] in position and again lock the tool.

Repeat the operations for the extraction of the pin of the 2nd planet wheel gear (Item 2) [Figure 40-21-39].

Repeat the operations for the two remaining pins.

Figure 40-21-40

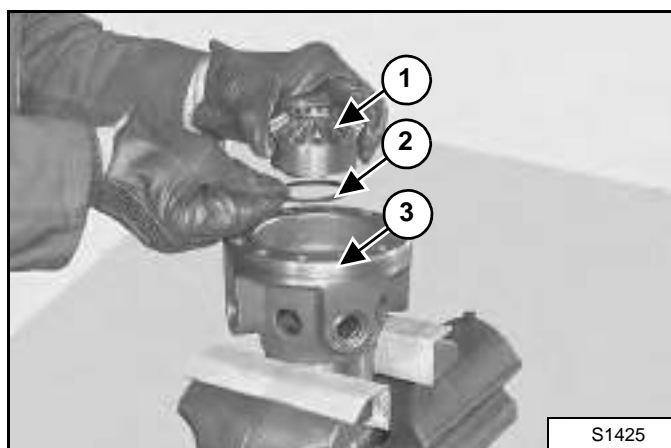

Remove the tool T and remove the planet wheel gears (Item 1) and the relative shim washers (Item 2) from the differential carrier (Item 3) [Figure 40-21-40].



## AXLE AND DIFFERENTIAL (REAR) (CONT'D)

### Bevel pinion Disassembly

Figure 40-21-41

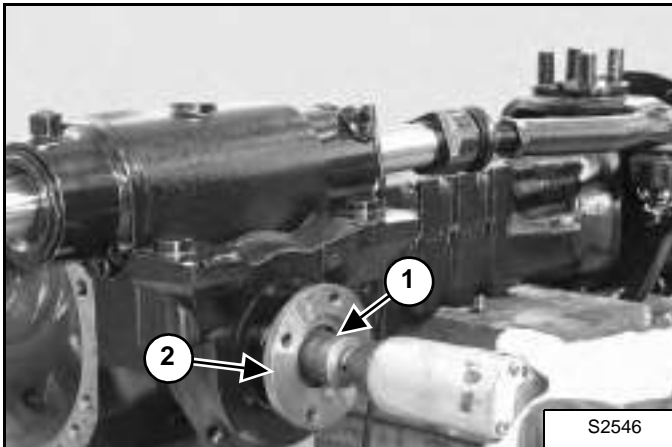

If disassembly is awkward, heat the check nut (Item 1) of the flange (Item 2) [Figure 40-21-41] to 80°C.

**NOTE:** Heating is meant to unloose the setting of Loctite on the nut. Always be careful with hot parts.

Figure 40-21-42

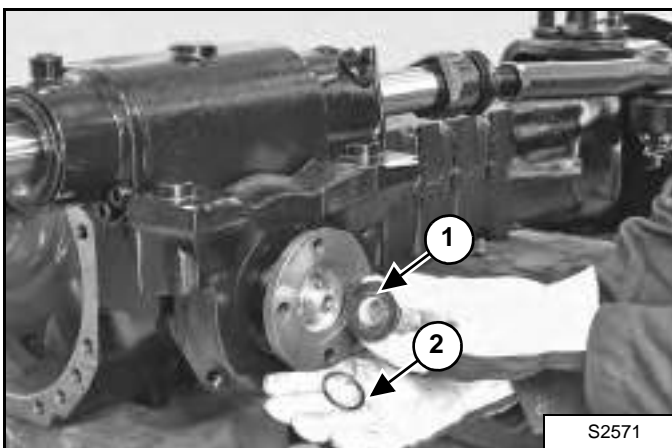

Remove the nut (Item 1) and remove the O-ring (Item 2) [Figure 40-21-42].

Figure 40-21-43

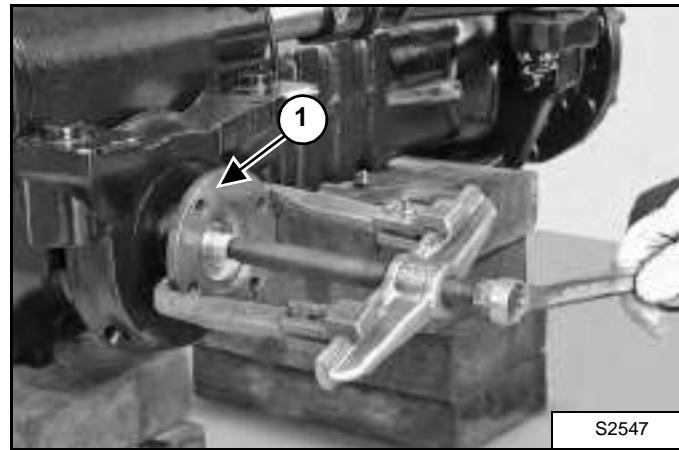

Remove the flange (Item 1) [Figure 40-21-43] complete with guard by means of a puller.

Figure 40-21-44

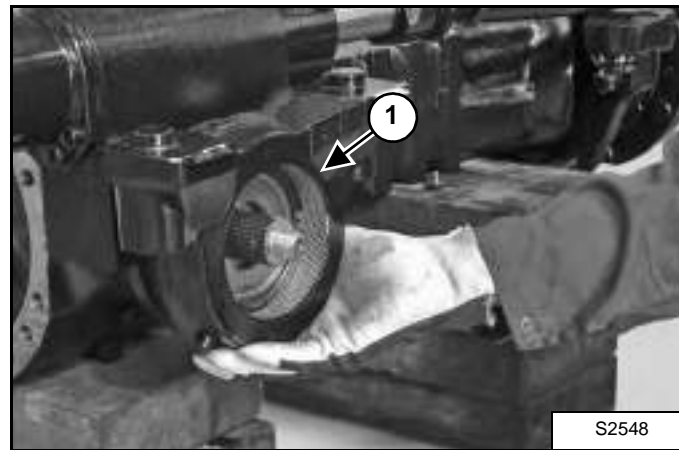

Remove the swinging support (Item 1) [Figure 40-21-44].

## AXLE AND DIFFERENTIAL (REAR) (CONT'D)

### Bevel pinion Disassembly (cont'd)

Figure 40-21-45

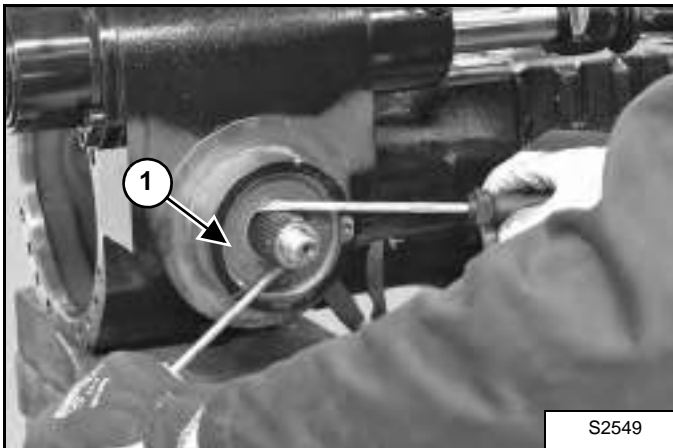

Remove the sealing ring (Item 1) [Figure 40-21-45].

Figure 40-21-46

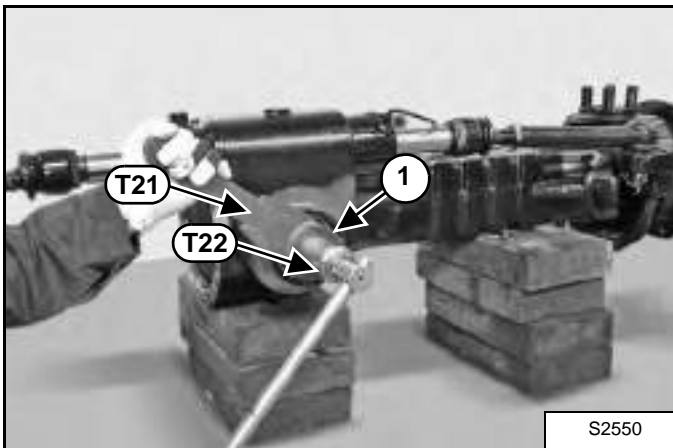

Position wrench **T22** onto the ring nut (Item 1) [Figure 40-21-46] and apply bar hold **T21** to the pinion (Item 1) [Figure 40-21-47].

Stop wrench **T22** and rotate the pinion so as to release and remove the ring nut (Item 1) [Figure 40-21-46].

**NOTE:** If disassembly proves awkward, heat the ring nut to approx. 80°C.

Figure 40-21-47

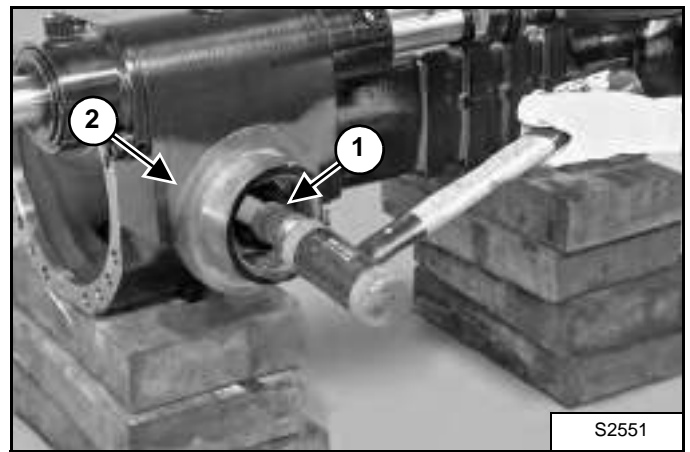

Extract the pinion (Item 1) [Figure 40-21-47] complete with the internal bearing, the distance piece and shims.

**NOTE:** The bearing races remain in the central body (Item 2) [Figure 40-21-47].

Figure 40-21-48

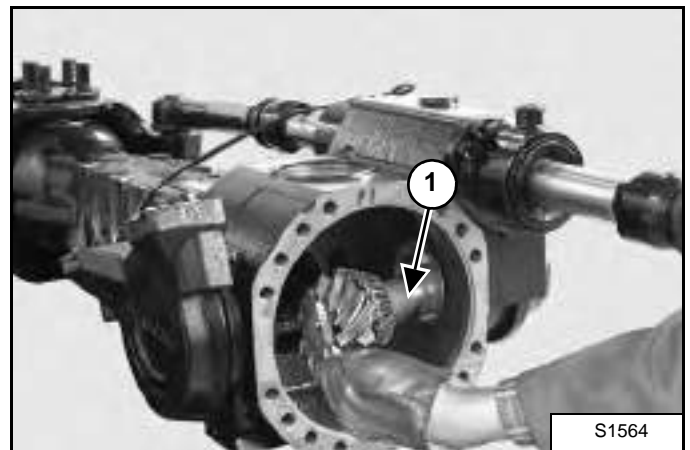

Remove the pinion (Item 1) [Figure 40-21-48], shims and distance piece.

## AXLE AND DIFFERENTIAL (REAR) (CONT'D)

### Bevel pinion Disassembly (cont'd)

Figure 40-21-49

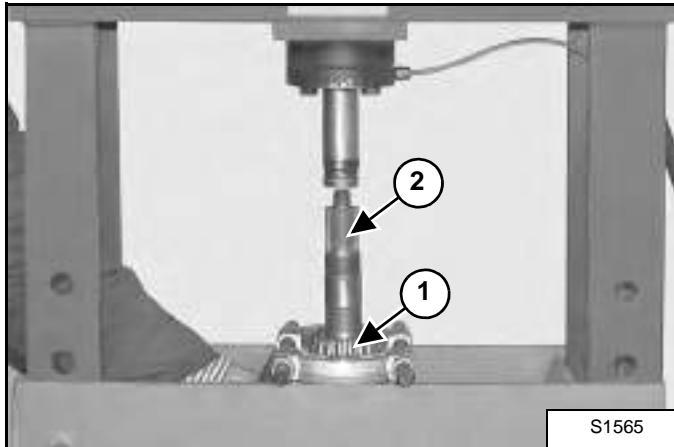

Using a puller and a press, remove the inner bearing (Item 1) from the pinion (Item 2) [Figure 40-21-49].

Figure 40-21-50

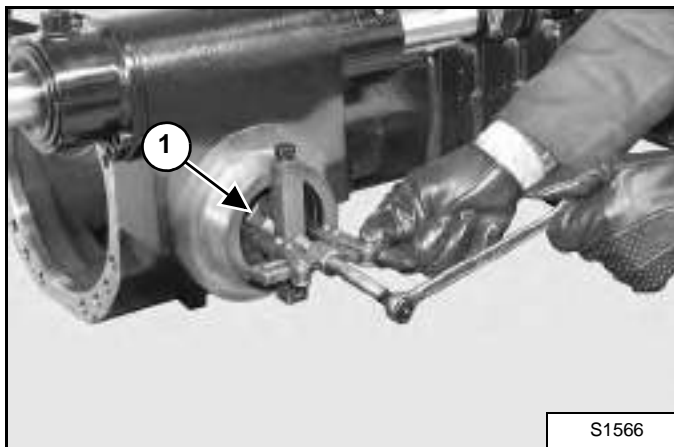

Remove the bearing race of the external bearing (Item 1) [Figure 40-21-50].

Figure 40-21-51

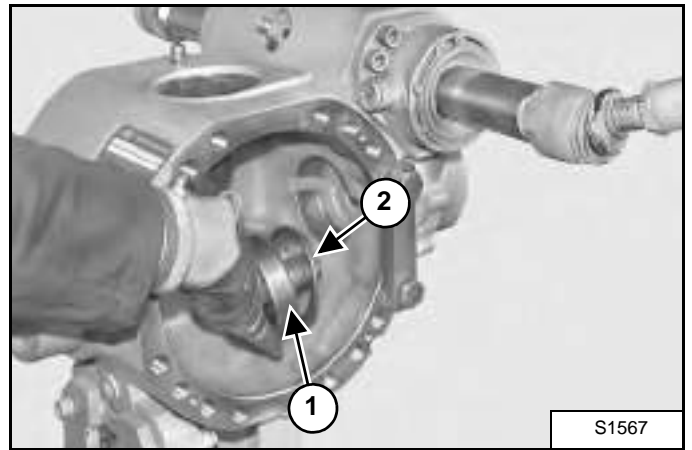

Insert a drift in the appropriate holes and remove the bearing race (Item 1) as well as the shim washers (Item 2) [Figure 40-21-51].

## AXLE AND DIFFERENTIAL (REAR) (CONT'D)

### Bevel pinion Assembly

Figure 40-21-52

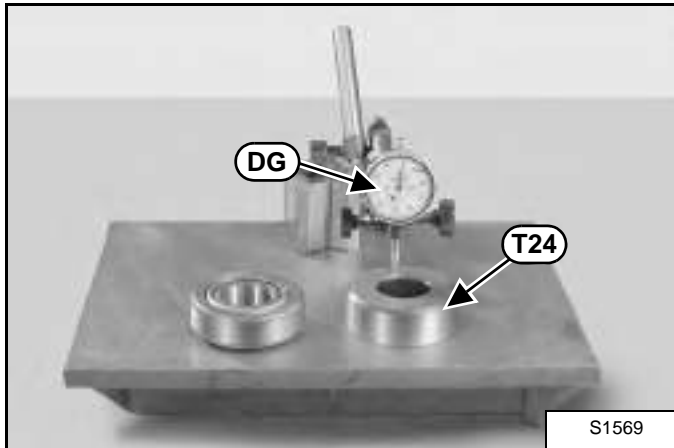

Using a surface plate, reset a magnetic based dial indicator and placing it on the measurement ring **T24** (with a thickness of 30,2 mm) [Figure 40-21-52].

Preset the indicator to approx. 2mm.

Figure 40-21-53

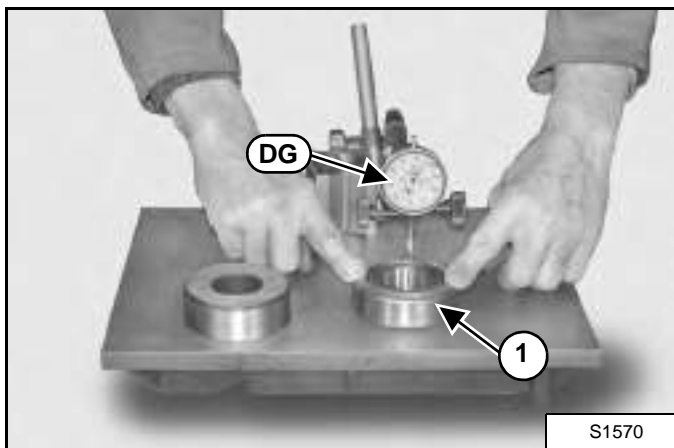

Bring the internal bearing (Item 1) [Figure 40-21-53], complete with its bearing race, under the indicator. Determine overall thickness "D" of the bearing checking the discrepancy between this size and the size of the measurement ring.

**NOTE:** Press the bearing race in the centre and take several measurements while rotating the bearing race.

Figure 40-21-54

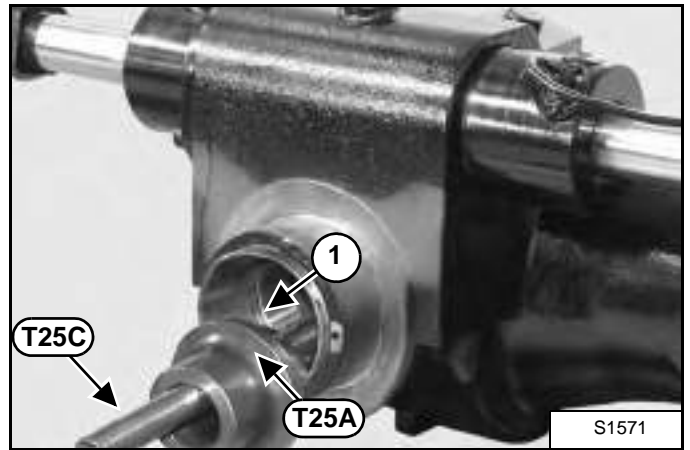

Partially insert the bearing race (Item 1) [Figure 40-21-54].

Figure 40-21-55

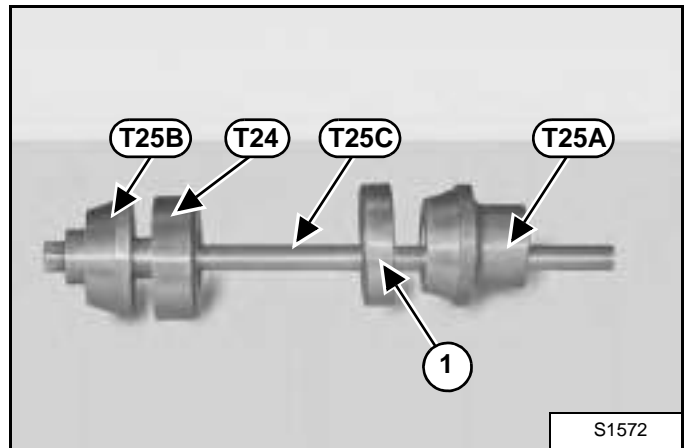

Install tension rod **T25C**, measurement ring **T24** and front guide tool **T25A** on the bearing race of the external bearing (Item 1) [Figure 40-21-55].

## AXLE AND DIFFERENTIAL (REAR) (CONT'D)

### Bevel pinion Assembly (Cont'd)

Figure 40-21-56

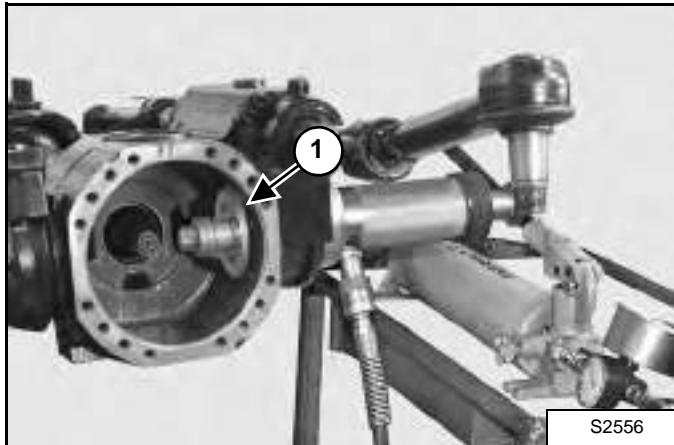

Connect the tension rod to the press and move the bearing race (Item 1) [Figure 40-21-54] into its seat. Disconnect the press and remove the tension rod.

**NOTE:** Before starting the next stage, make sure that the bearing race has been completely inserted into its seat.

Figure 40-21-57

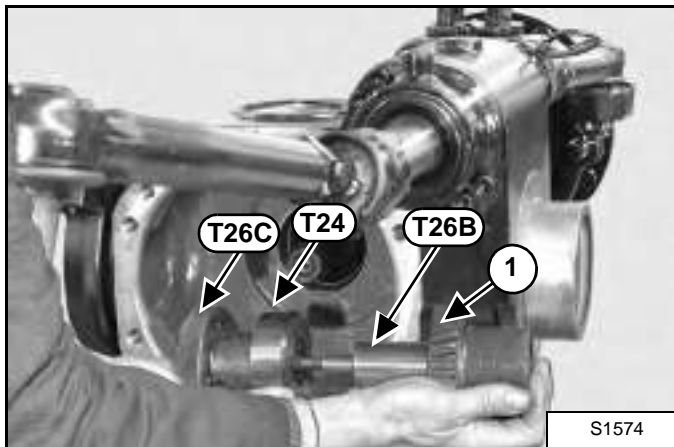

Insert tool **T26B** complete with external bearing (Item 1) [Figure 40-21-57], measurement ring **T24** and gauged ring nut **T26C** and manually tighten.

Figure 40-21-58

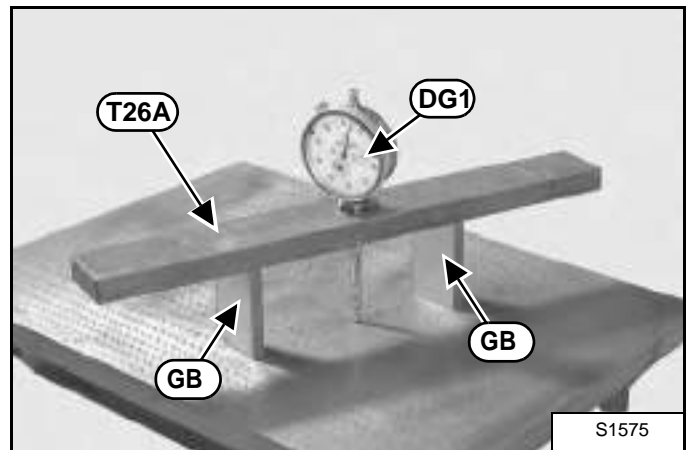

Fit a magnetic based dial indicator with long stem into bar **T26A**; when the bar rests on two size-blocks "GB" of 57mm, reset the indicator. Preset the indicator to approx. 2 mm and reset [Figure 40-21-58].

Figure 40-21-59

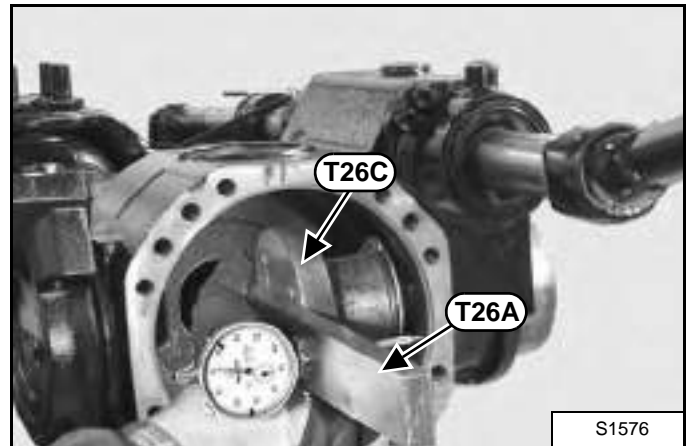

Lay bar **T26A** on gauged nut **T26C** and take the size "A" at about 57 mm corresponding to the maximum diameter of arms centring [Figure 40-21-59].

## AXLE AND DIFFERENTIAL (REAR) (CONT'D)

### Bevel pinion Assembly (Cont'd)

Figure 40-21-60

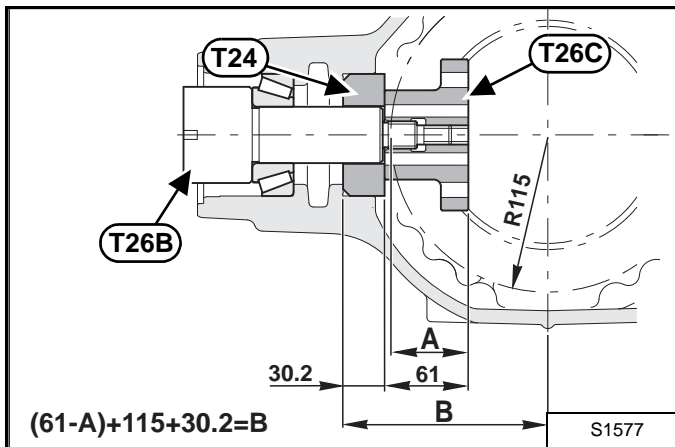

Calculate size "B" which will be the first useful value for calculating the size of the shims that are to be inserted under the bearing race [Figure 40-21-60].

Figure 40-21-61

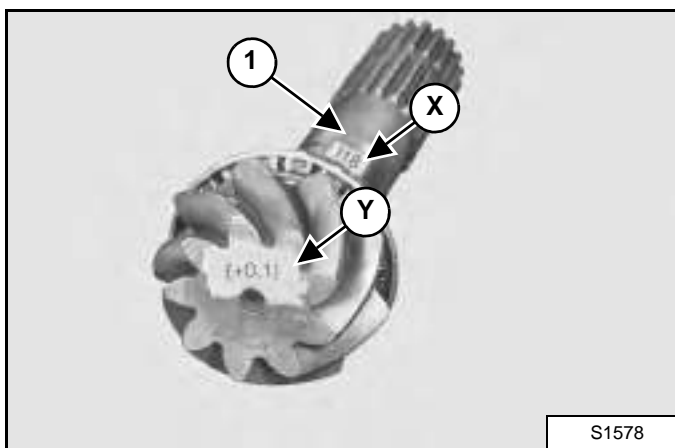

Check the nominal size (X) marked on the pinion (Item 1) [Figure 40-21-61] and add or subtract the indicated variation (Y) so as to obtain size (Z).

e.g.:  $Z = 118 + 0,1 = 118.1$   
 $Z = 118 - 0.2 = 117.8$

Figure 40-21-62

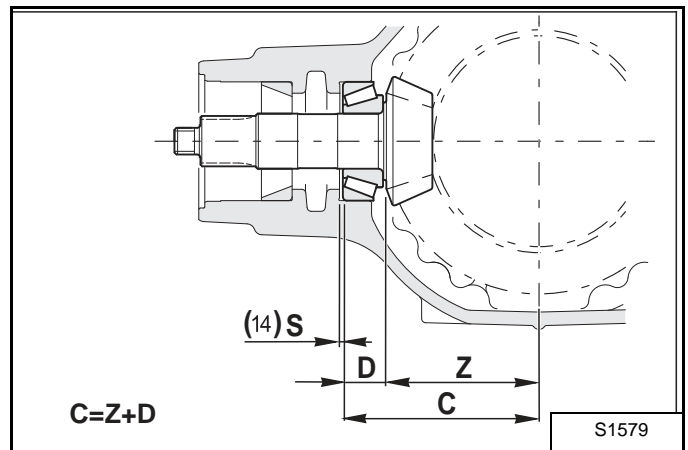

Calculate size "C" which represents the second value for calculating the size of the shims "S" that are to be placed under the bearing race [Figure 40-21-62].

Figure 40-21-63

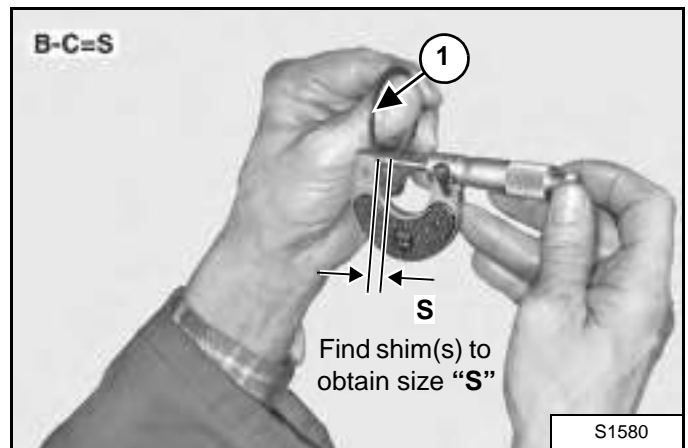

Calculate the difference between sizes "B" and "C" so as to obtain the size "S" of the shim (Item 1) [Figure 40-21-63] that will go under the bearing race.

## AXLE AND DIFFERENTIAL (REAR) (CONT'D)

### Bevel pinion Assembly (Cont'd)

Figure 40-21-64

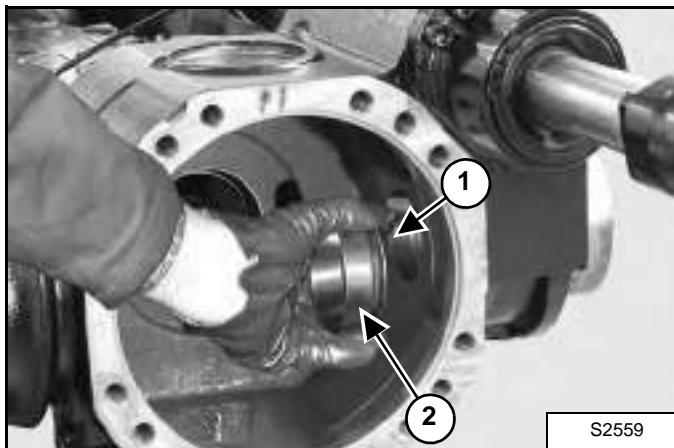

Insert shim "S" (Item 1) and the bearing race of the internal bearing (Item 2) [Figure 40-21-64] in the central body.

Figure 40-21-65

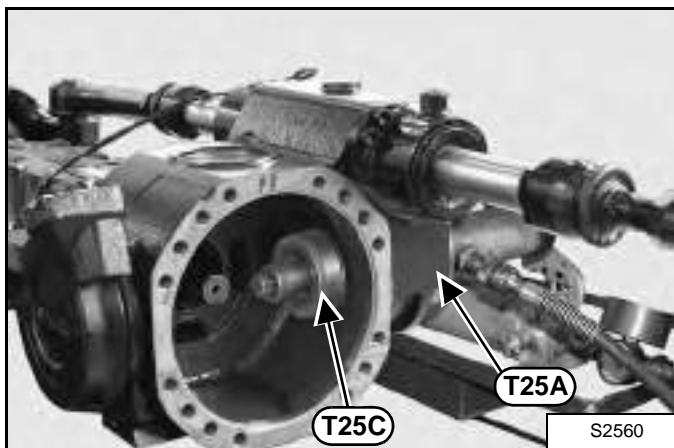

Position tool **T25A** and tension rod **T25C**. Connect the tension rod to the press, fasten the bearing race and then remove the tools [Figure 40-21-65].

**NOTE:** Before going on to the next stage, make sure that the bearing race has been completely inserted.

Figure 40-21-66

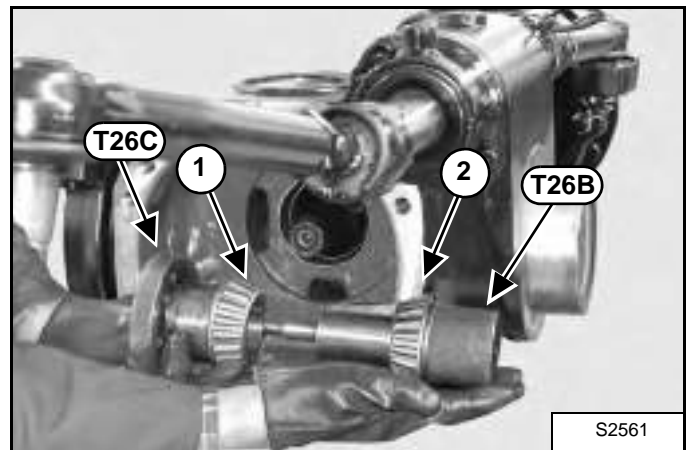

Position tools **T26C** and **T26B** complete with tapered bearings (Item 1 and 2) [Figure 40-21-66]; manually tighten until a rolling torque has been obtained.

Figure 40-21-67

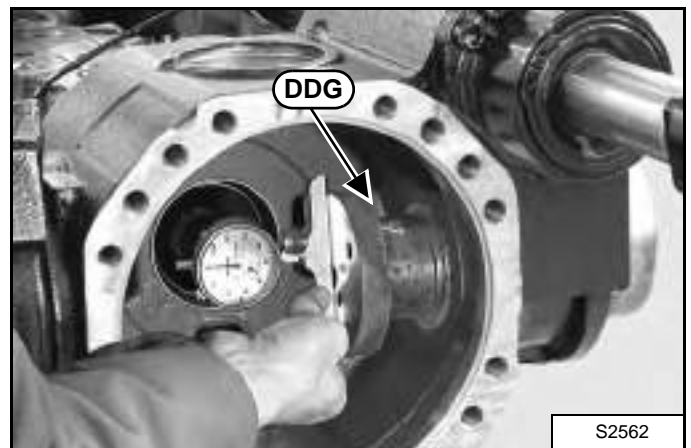

Insert the stem of a depth dial indicator in either side hole of tool **T26C**; reset the indicator with a presetting of approx. 3 mm [Figure 40-21-67].

## AXLE AND DIFFERENTIAL (REAR) (CONT'D)

### Bevel pinion Assembly (Cont'd)

Figure 40-21-68

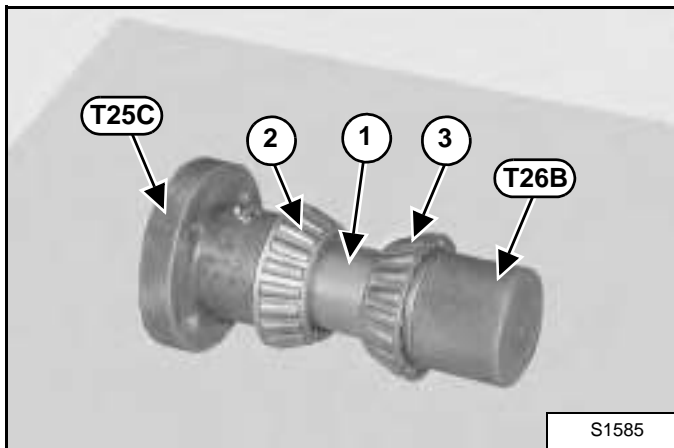

Remove the indicator and release tools and bearings from the central body.

Re-install all and insert the distance piece (Item 1) between both bearings (Item 2 and 3) [Figure 40-21-68]; manually tighten the whole pack.

Figure 40-21-69

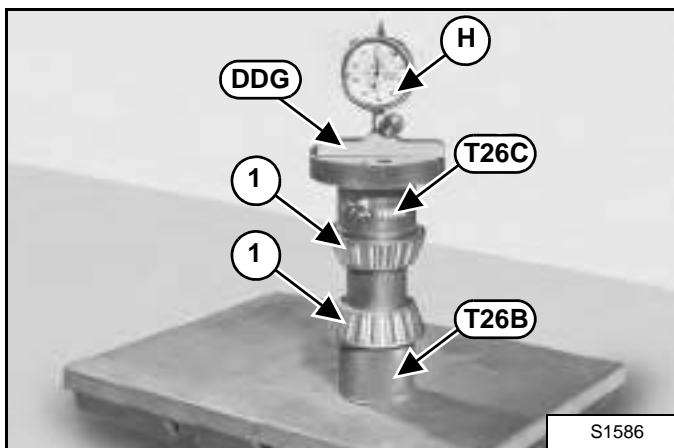

Insert depth dial indicator into tool **T26B-T26C** and measure variation "H" in relation to the zero setting performed in [Figure 40-21-69].

Figure 40-21-70

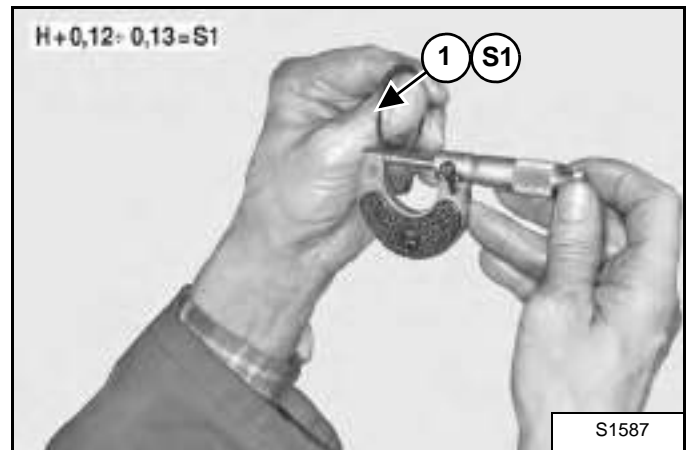

The variation is to be added to a set value of 0,12-0,13 mm, so as to obtain the size of shim "S1" (Item 1) [Figure 40-21-70] which will be inserted between the external bearing (Item 1) [Figure 40-21-69] and the distance piece (Item 1) [Figure 40-21-68] and subsequently, to determine the preload for the bearings.

Figure 40-21-71

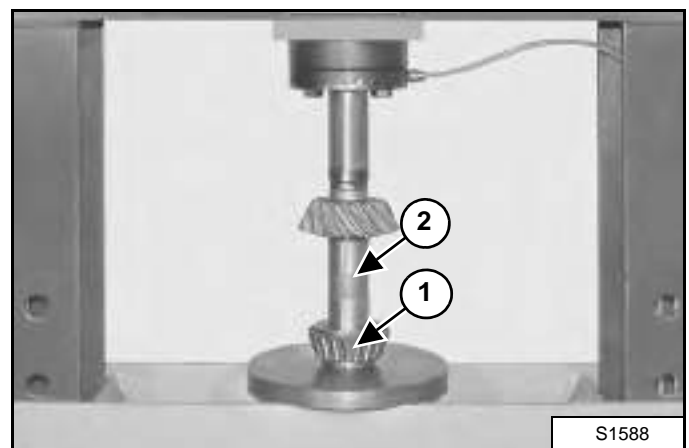

Position the internal bearing (Item 1) and the pinion (Item 2) [Figure 40-21-71] under a press. Force the bearing onto the pinion.



## AXLE AND DIFFERENTIAL (REAR) (CONT'D)

### Bevel pinion Assembly (Cont'd)

Figure 40-21-72

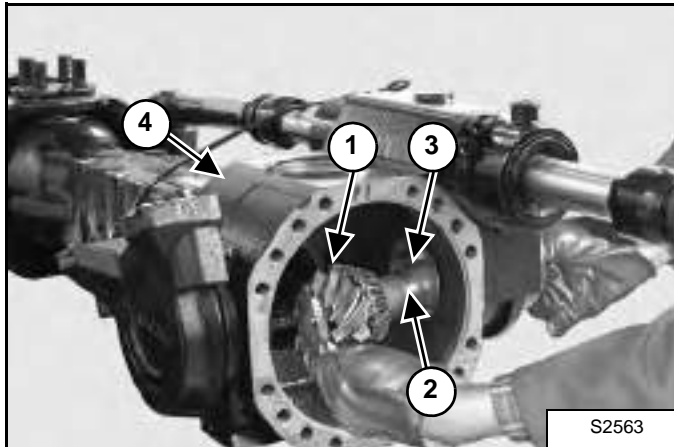

Fit the pinion (Item 1), shim "S1" (Item 2) and the distance piece (Item 3) in the main body (Item 4) [Figure 40-21-72].

**NOTE:** The finer shims must be placed in between the thicker ones.

Figure 40-21-73

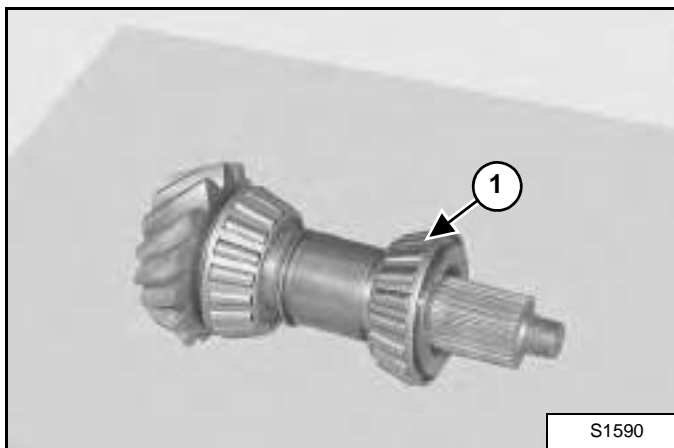

Insert the external bearing (Item 1) [Figure 40-21-73] in the central body in order to complete the pack arranged as in the figure.

Figure 40-21-74

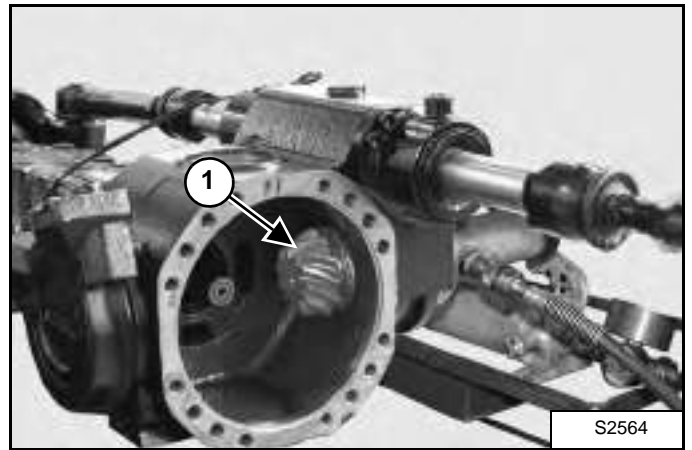

Connect the pinion (Item 1) [Figure 40-21-74] to the tie rod **T28A** and **T28B**. Connect the tie rod **T28C** to the press and block.

Figure 40-21-75

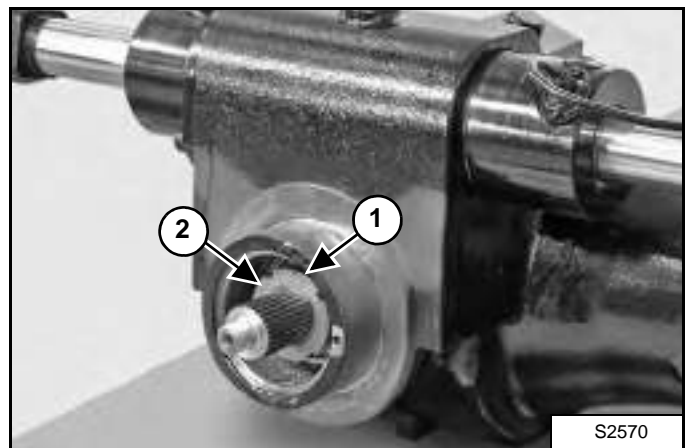

Apply Loctite 242 to the thread of the ring nut (Item 1) and screw the nut onto the pinion (Item 2) [Figure 40-21-75].

## AXLE AND DIFFERENTIAL (REAR) (CONT'D)

### Bevel pinion Assembly (Cont'd)

Figure 40-21-76

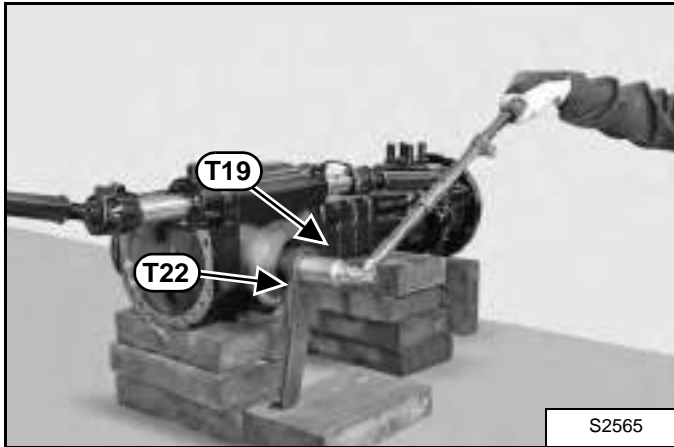

Apply special wrench **T22** to the ring nut (Item 1) and bar-hold **T19** to the pinion (Item 2) [Figure 40-21-75]. Lock the wrench **T22** and rotate the pinion using a dynamometric wrench, up to a minimum required torque setting of 370 ft.-lb. (500 N•m) [Figure 40-21-76].

Figure 40-21-77

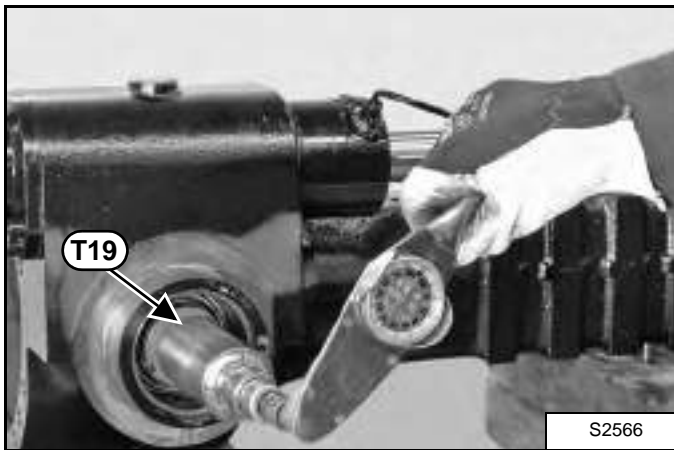

Apply onto the pinion (Item 2) [Figure 40-21-75] the bar-hold and with the help of a torque metre, check the torque of the pinion [Figure 40-21-77].  
Torque: 120-170 N•m.

**NOTE:** If torque exceeds the maximum value, then the size of shim "S1" between the bearing and the distance piece needs to be increased.

**NOTE:** If torque does not reach the set value, increase the torque setting of the ring nut in different stages to obtain a maximum value of 420 ft.-lb. (570 N•m).

**NOTE:** If torque does not reach the minimum value, then the size of shim "S1" needs to be reduced.

**NOTE:** When calculating the increase or decrease in size of shim "S1", bear in mind that a variation of shim of 0,01 mm corresponds to a variation of 0.44 ft.-lb. (60 N•m) in the torque of the pinion.

## AXLE AND DIFFERENTIAL (REAR) (CONT'D)

### Bevel pinion Assembly (Cont'd)

Figure 40-21-78

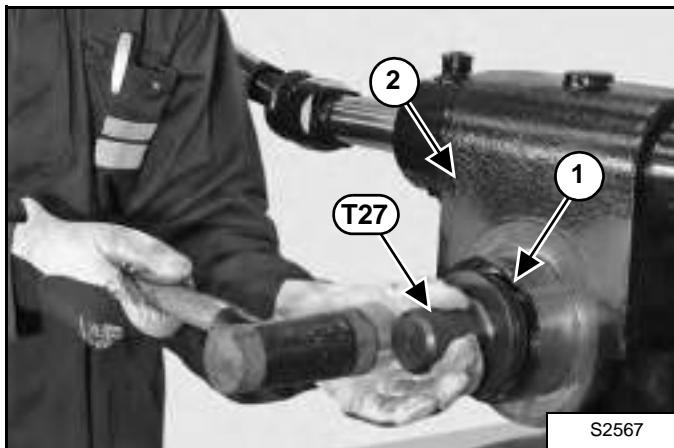

Lubricate the outer surface of the new sealing ring (Item 1) and fit it onto the central body (Item 2) [Figure 40-21-78] using tool T27.

Figure 40-21-79

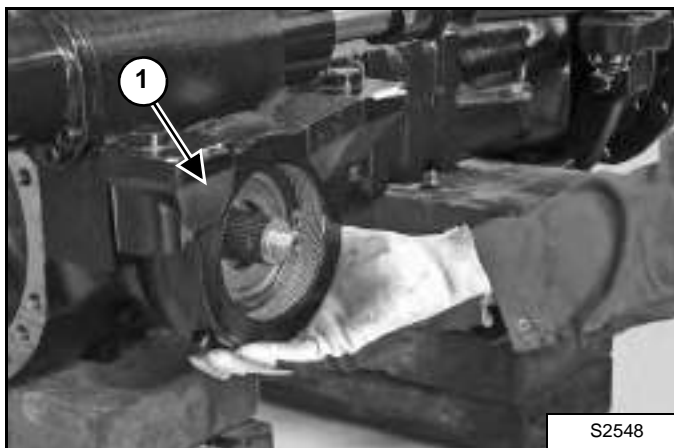

Install the swinging support (Item 1) [Figure 40-21-79].

**NOTE: Check that it is properly oriented.**

Figure 40-21-80

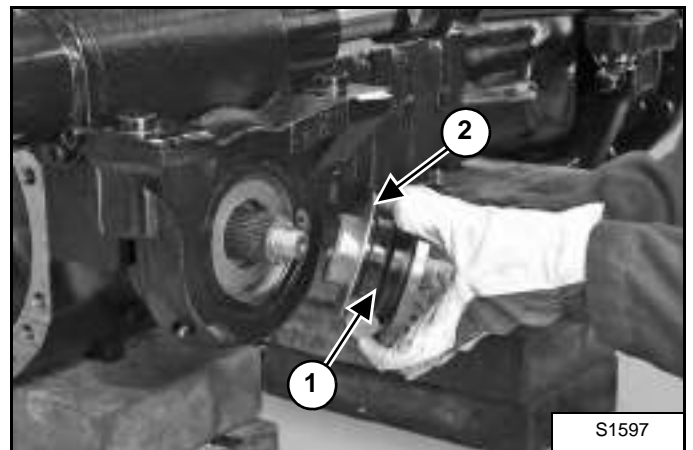

Fit the flange (Item 1) complete with the guard (Item 2) [Figure 40-21-80] and fasten it. For aligning the flange, use a plastic hammer if necessary.

**NOTE: Make sure that the guard is securely fastened onto the flange and that it is not deformed.**

Figure 40-21-81

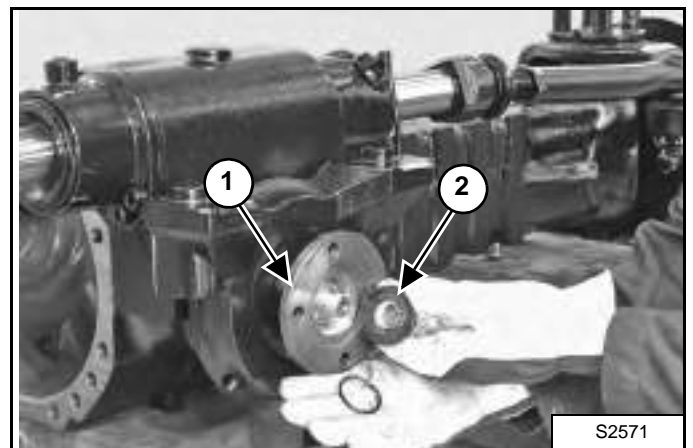

Apply Loctite 242 to the threaded part of the pinion (Item 2) [Figure 40-21-75]. Position tool T20A (or T20B) and fasten it in order to avoid rotation. Insert the O-ring (Item 1) and the nut (Item 2) [Figure 40-21-41] and tighten it using a dynamometric wrench. Torque wrench setting: 207 - 229 ft.-lb. (280-310 N•m).

## AXLE AND DIFFERENTIAL (REAR) (CONT'D)

### Differential Assembly

Figure 40-21-82

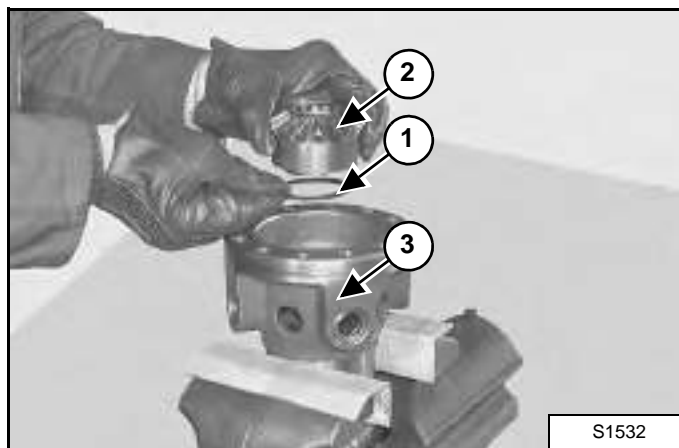

Insert the shim washer (Item 1) and the planetary gear (Item 2) in the differential carrier (Item 3) [Figure 40-21-82].

Figure 40-21-83

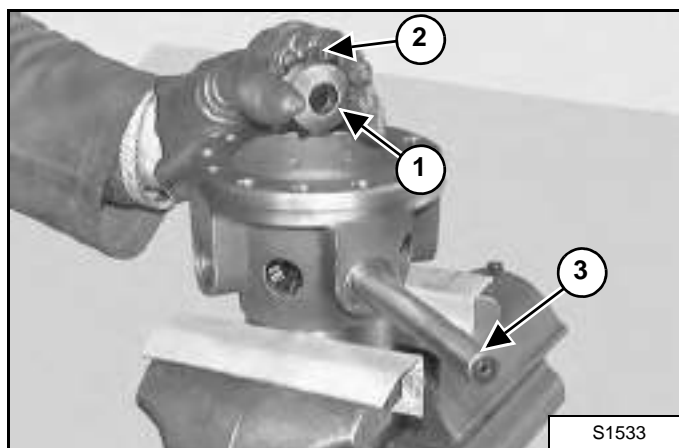

Position the shim washer (Item 1) and the first planet wheel gear (Item 2). Hold them in position using a bar (Item 3) [Figure 40-21-83].

Figure 40-21-84

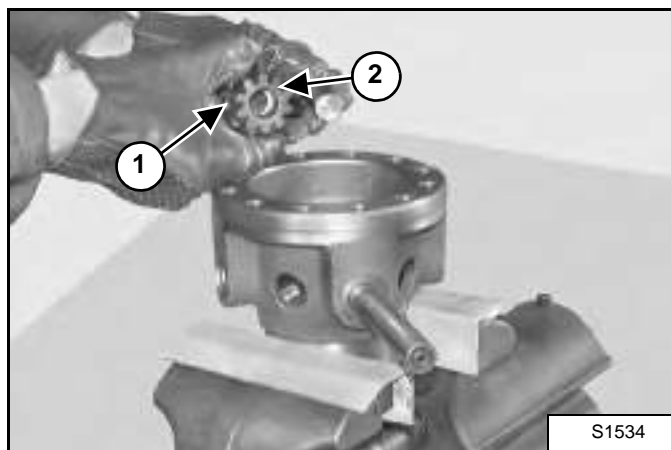

With the help of a bar, position the second planet wheel gear (Item 1) and the relative shim washer (Item 2) [Figure 40-21-84].

Figure 40-21-85

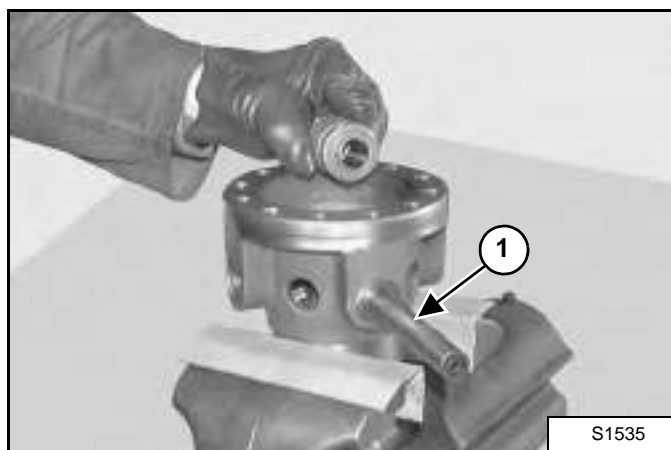

Insert a tool between the two planetary gears and (Item 1) [Figure 40-21-84]. Line up the entire unit by pushing the bar all the way down until it is ejected.

## AXLE AND DIFFERENTIAL (REAR) (CONT'D)

### Differential assembly (Cont'd)

Figure 40-21-86

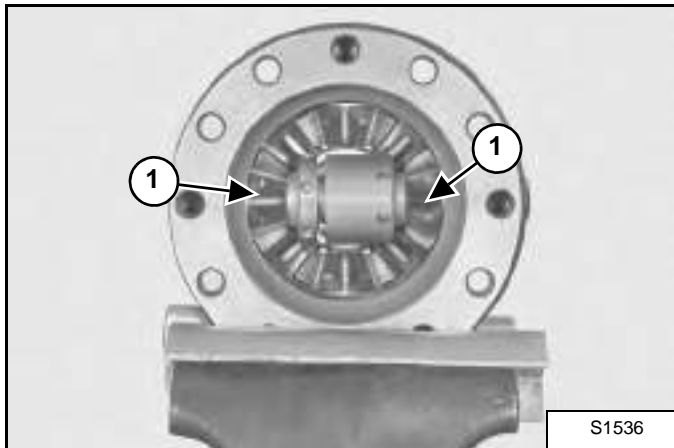

Lock the tool behind the planet wheel gears (Item 1) [Figure 40-21-86]. After locking, remove bar T16C.

Figure 40-21-87

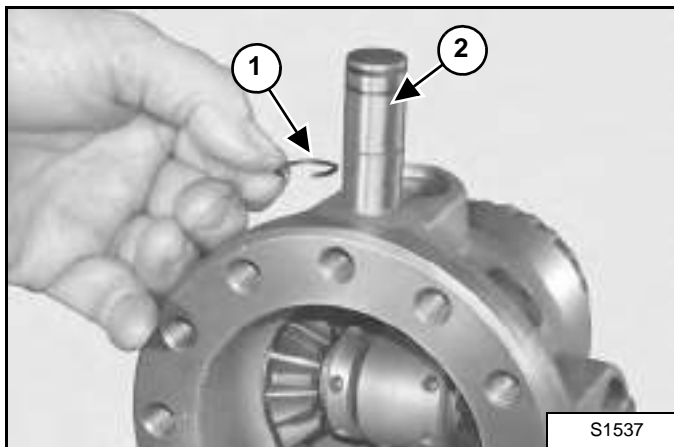

Fit the snap rings (Item 1) onto the pins (Item 2) [Figure 40-21-87].

Figure 40-21-88

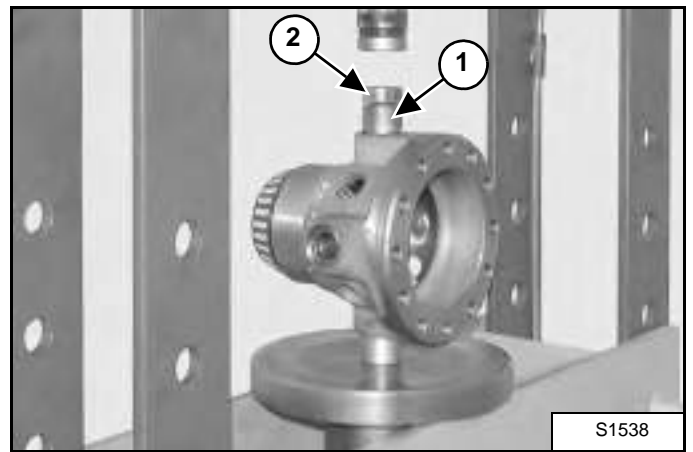

Place the differential carrier under the press, position bushing (Item 1) and insert the planet wheel pin (Item 2) [Figure 40-21-88].

Figure 40-21-89

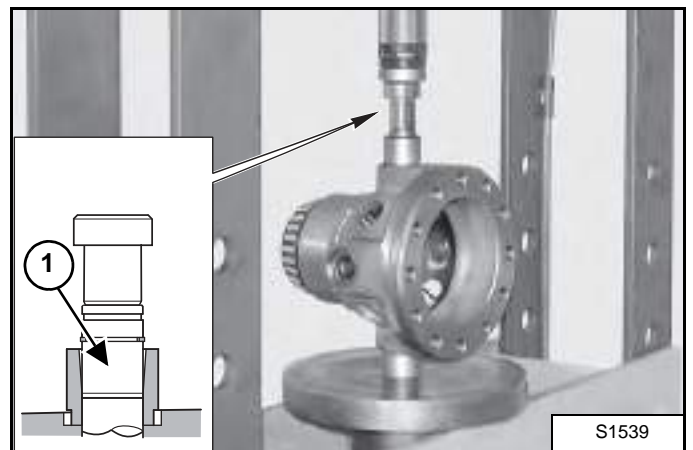

Put a tool pin on top of the planet wheel pin (Item 1) [Figure 40-21-89].

## AXLE AND DIFFERENTIAL (REAR) (CONT'D)

### Differential assembly (Cont'd)

Figure 40-21-90

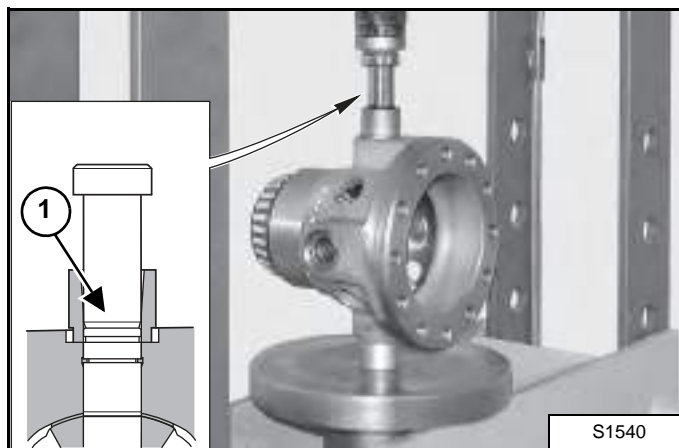

Press the pin all the way down (Item 1) [Figure 40-21-90].

Figure 40-21-91

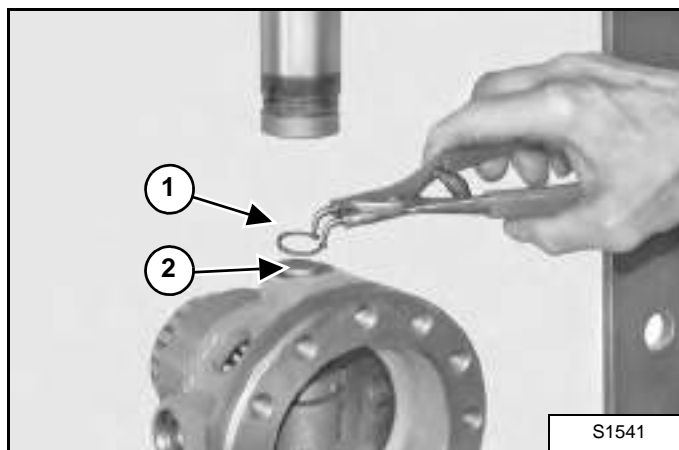

Remove tool pin, bushing and fit the snap ring (Item 1) on the pin (Item 2) [Figure 40-21-91].

**NOTE:** Make sure that the snap ring centres the seat and that it rests on the surface of the differential carrier.  
Repeat the operations on the other planet wheel pin or planet wheel axle.

Figure 40-21-92

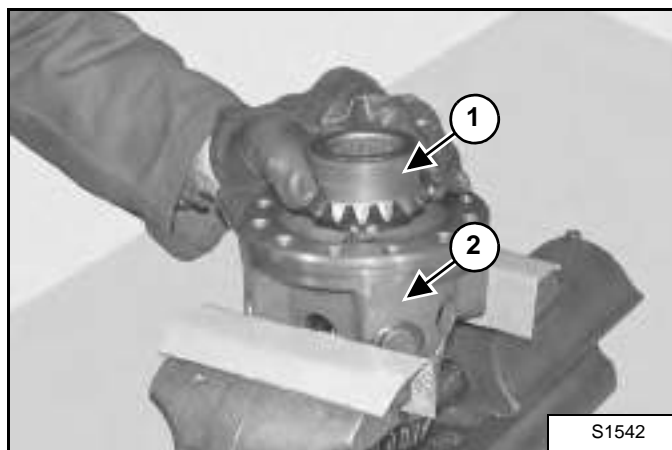

Position the second planetary gear (Item 1) in the differential carrier (Item 2) [Figure 40-21-92].

Figure 40-21-93

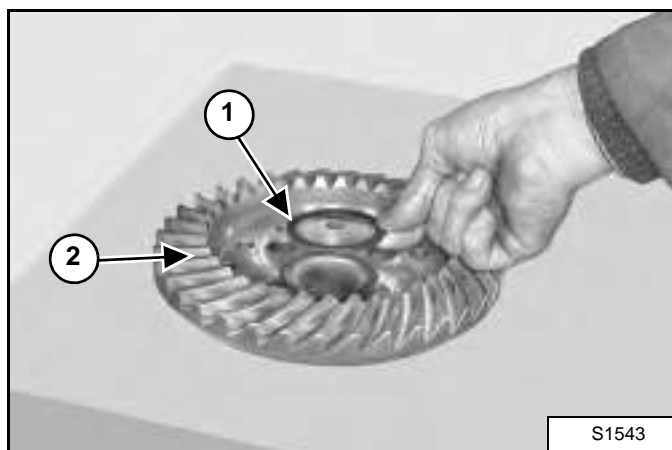

Position the shim washer (Item 1) on the crown (Item 2) [Figure 40-21-93].

**NOTE:** In order to hold the shim washer in position, apply grease to it.

## AXLE AND DIFFERENTIAL (REAR) (CONT'D)

### Differential assembly (Cont'd)

Figure 40-21-94

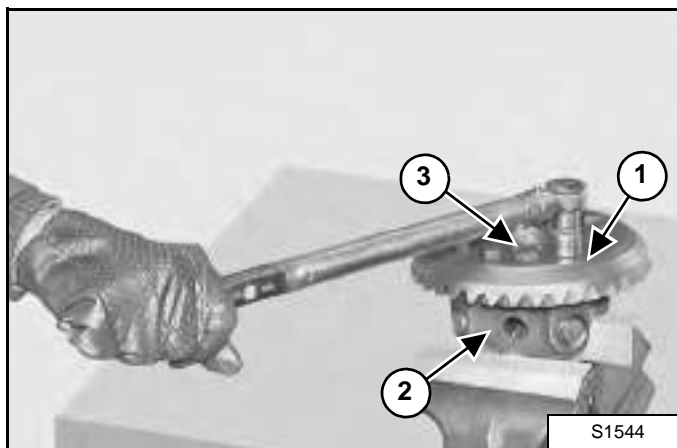

Position the crown (Item 1) on the differential carrier (Item 2) and lock it with screws (Item 3) [Figure 40-21-94] applied with Loctite 242.

Torque wrench setting for screws: 94 - 105 ft.-lb. (128-142 N•m).

**NOTE: Secure the screws using the cross tightening method.**

Figure 40-21-95

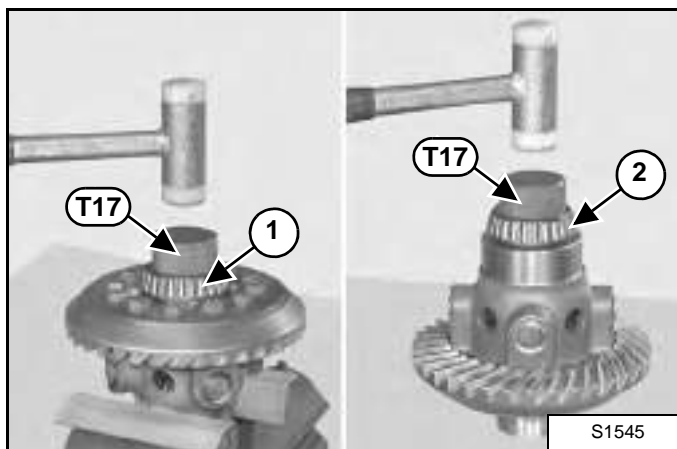

Install the bearing races (Item 1 and 2) [Figure 40-21-95] using tool T17.

Figure 40-21-96

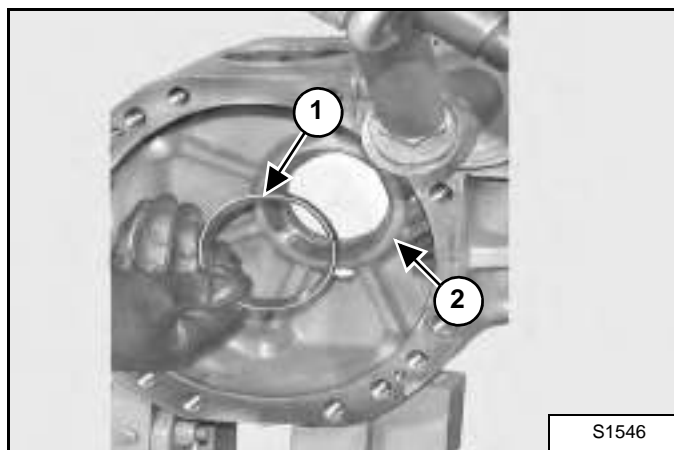

If the bearings are replaced, insert the external bearing races (Item 1) in the central body (Item 2) [Figure 40-21-96].

Figure 40-21-97

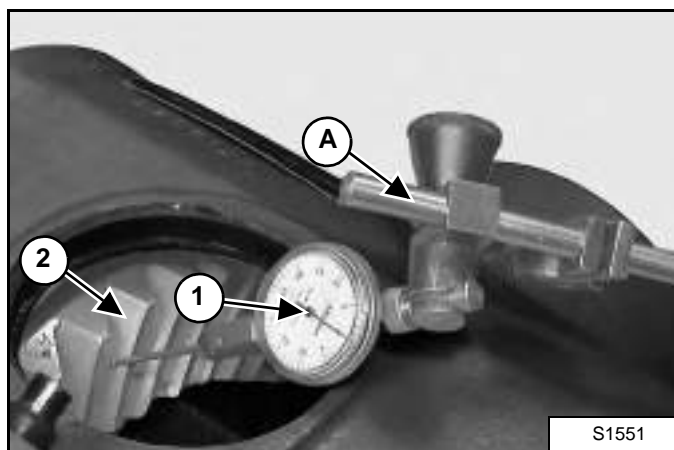

Introduce a dial indicator with rotary key "A" through the top plug hole (Item 1). Position the indicator on the centre of one of the teeth of the crown (Item 2) [Figure 40-21-97] and pre-set it to 1 mm and reset it.

## AXLE AND DIFFERENTIAL (REAR) (CONT'D)

### Differential assembly (Cont'd)

Figure 40-21-98

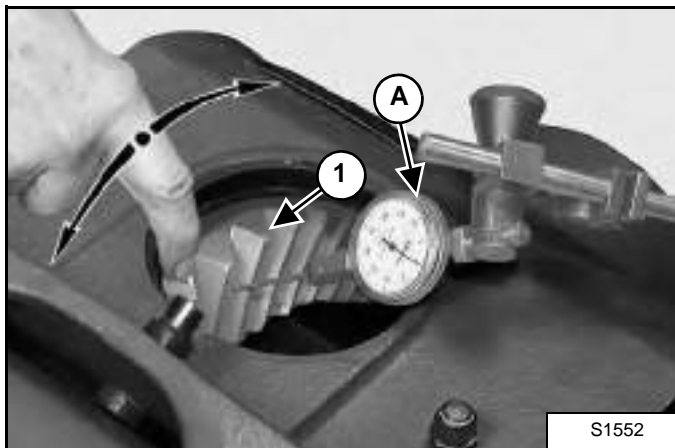

Manually move the crown (Item 1) [Figure 40-21-98] in both directions in order to check the existing backlash between the pinion and the crown.

**NOTE:** Difference between MIN and MAX clearance for whole circumference should not exceed 0,09 mm.

Figure 40-21-99

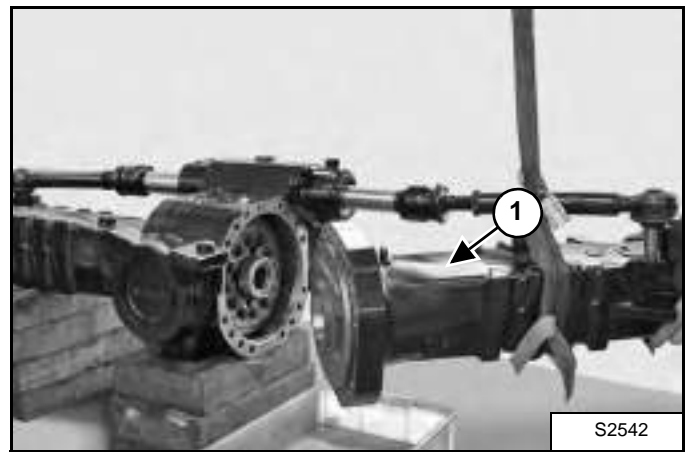

Re-install the complete arms (Item 1) [Figure 40-21-99].



## AXLE AND DIFFERENTIAL (REAR) (CONT'D)

### Steering Knuckle Assembly

Figure 40-21-100

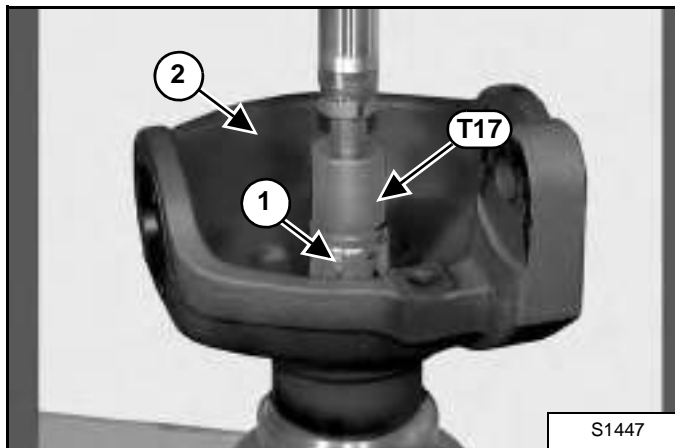

Lubricate the bushing (Item 1) and the seat of the steering case (Item 2). Install the bushing (Item 1) [Figure 40-21-100], using tool T17.

Figure 40-21-101

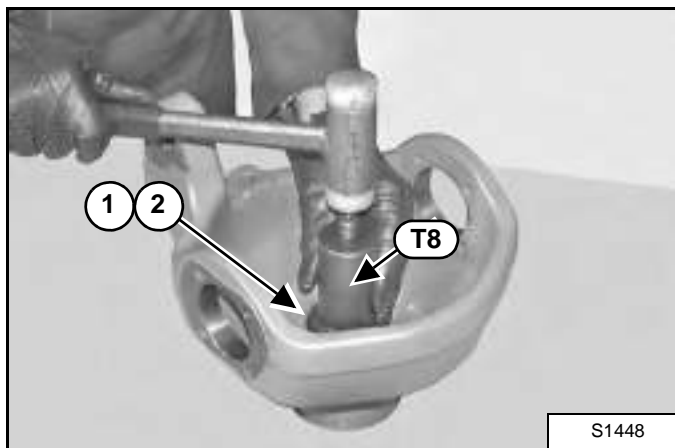

Lubricate the outer surface of the sealing ring (Item 1) and centering ring (Item 2) [Figure 40-21-101]. Fit them into their seat using tool T8.

Figure 40-21-102

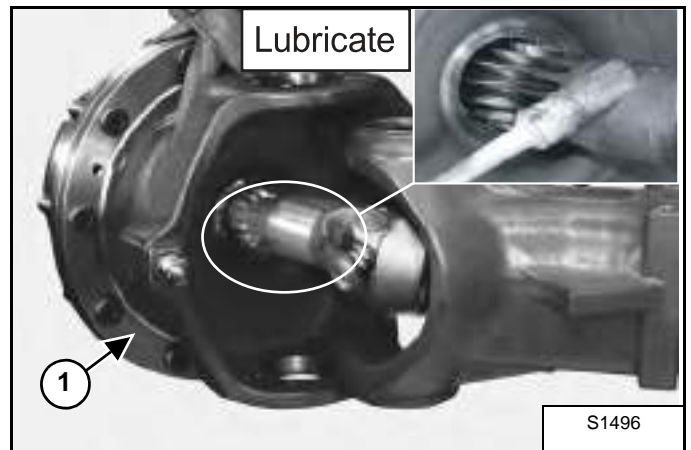

Lubricate the terminal of the drive axle and install the steering case (Item 1) [Figure 40-21-102]. Pay due attention not to damage the dust cover rings and the sealing rings.

Figure 40-21-103

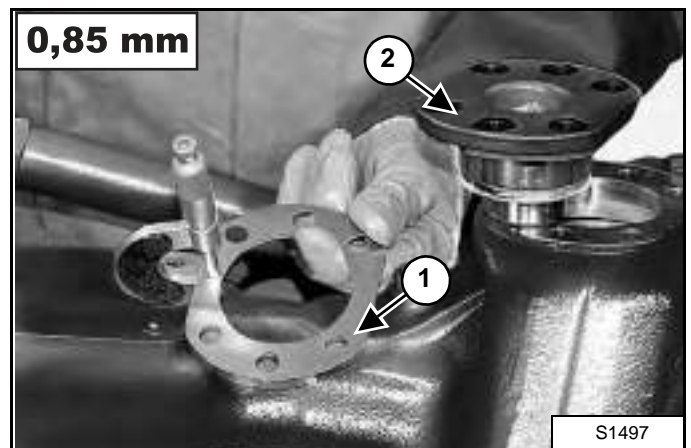

Prepare a series of shims (Item 1) of 0,85 mm. To be assembled under the upper pin (Item 2) [Figure 40-21-103].

## AXLE AND DIFFERENTIAL (REAR) (CONT'D)

### Steering Knuckle Assembly (Cont'd)

Figure 40-21-104

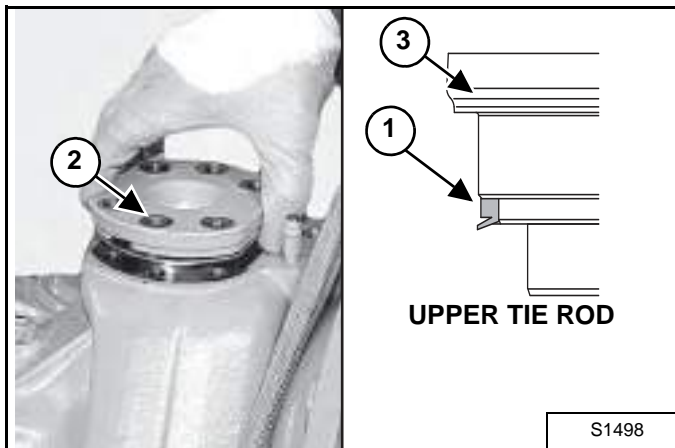

Fit a new seal (Item 1) onto the top tie rod (Item 3). Lubricate and install the unit in the steering case. Insert and tighten the 6 screws (Item 2), apply a torque of 103 ft.-lb. (140 N•m) using the cross tightening method. Check the correct assembly side of the seal (Item 1) [Figure 40-21-104].

Figure 40-21-105



Lubricate the group with grease and mount it in the steering case (Item 1) [Figure 40-21-105].

Figure 40-21-106

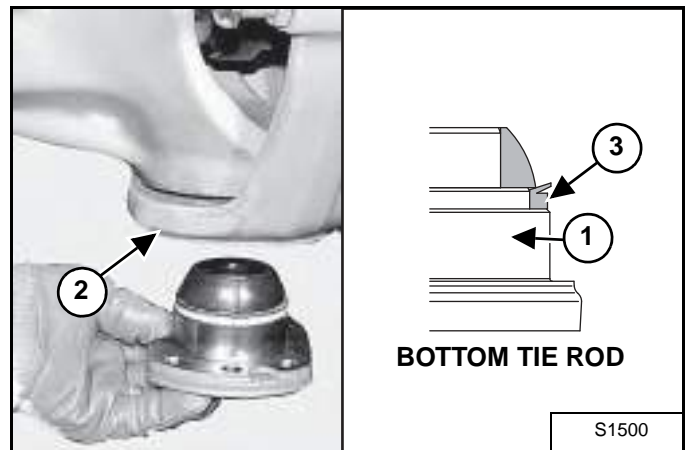

Fit the unit (Item 1) in the steering case (Item 2) [Figure 40-21-106]. Position the new screws and tighten.

Check for the correct assembly side of the seal (Item 3) [Figure 40-21-106].

Figure 40-21-107

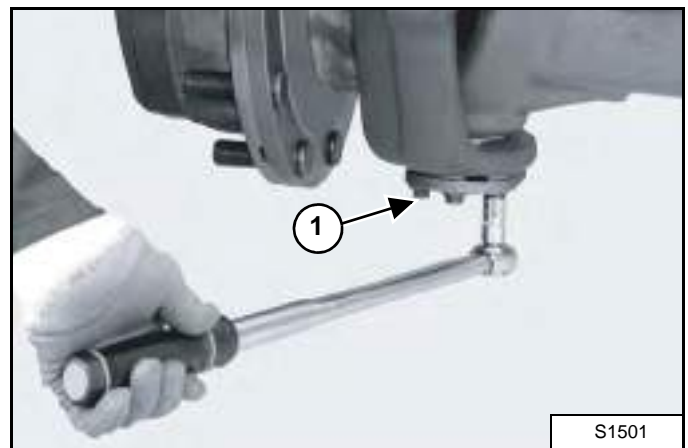

Tighten the fitting screws (Item 1) [Figure 40-21-107] of the bottom tie rod in sequence using the cross tightening method, apply a torque of 103 ft.-lb. (140 N•m).

## AXLE AND DIFFERENTIAL (REAR) (CONT'D)

### Steering Knuckle Assembly (Cont'd)

Figure 40-21-108

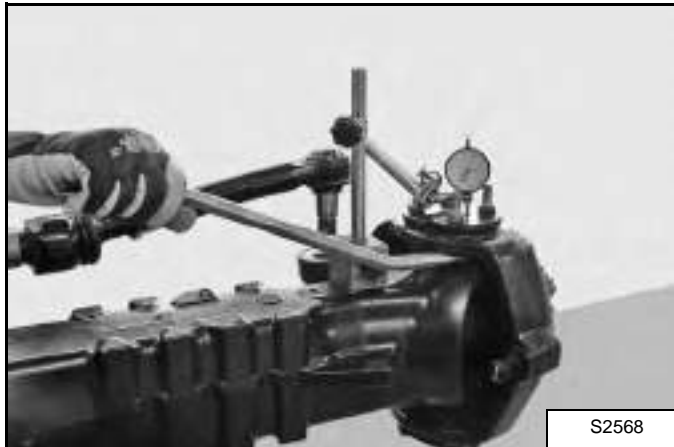

Install a magnetic based dial indicator on the steering housing. Check by means of a lever that there is no vertical gap. In case there is any gap, determine the width and reduce it by removing shims [Figure 40-21-108].

Figure 40-21-109

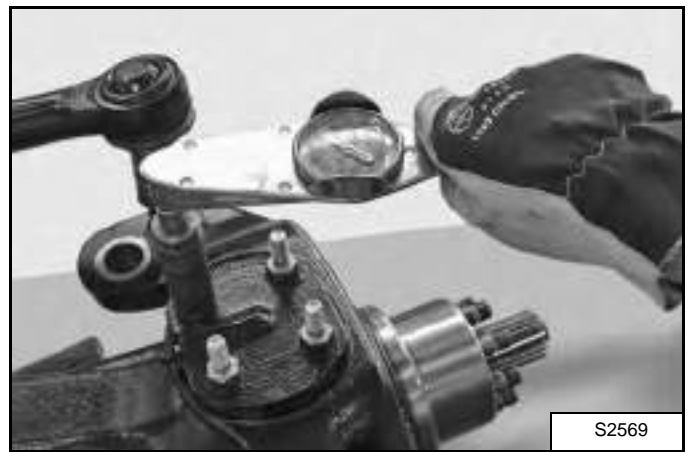

Check the torque of the pins, which has to be between 22 - 44 ft.-lb. (30 - 60 N•m). If the preliminary measured value is too high, the shims have to be increased [Figure 40-21-109].

## AXLE AND DIFFERENTIAL (REAR) (CONT'D)

### Planetary Carrier Assembly

Figure 40-21-110

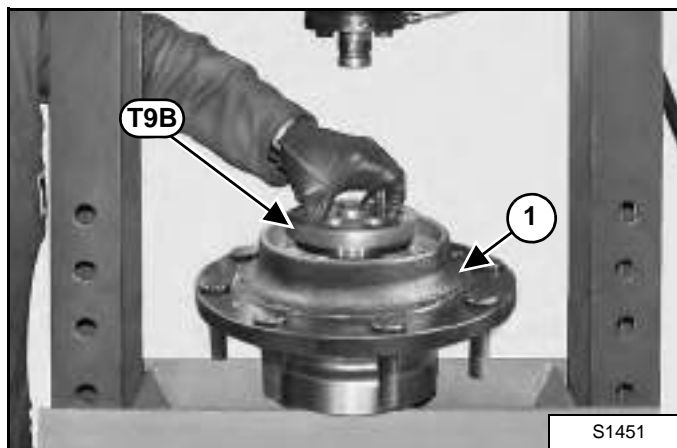

Position the upper part of tool **T9B** and press the bearing races into the hub (Item 1) [Figure 40-21-110] all the way down.

Figure 40-21-111

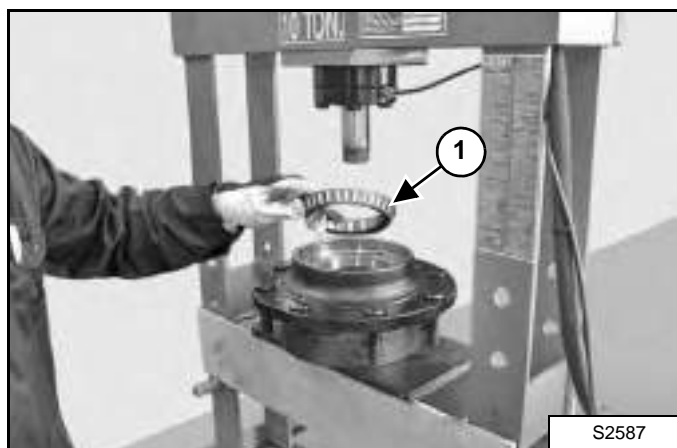

Fit the bearing (Item 1) [Figure 40-21-111] into the internal bearing race (wide side up).

Figure 40-21-112

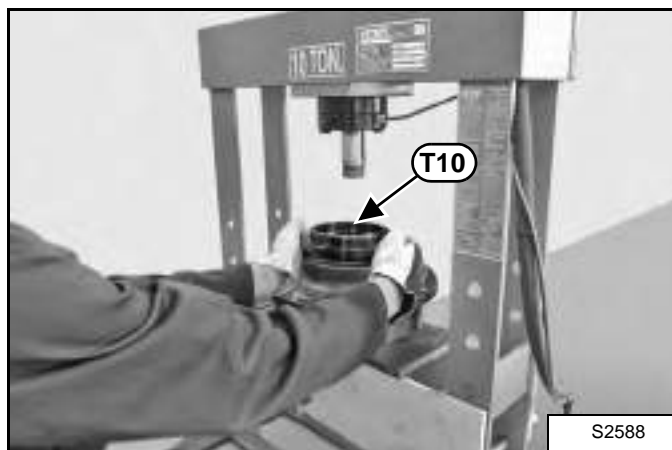

Position tool **T10** and press the sealing ring into its seat.

Figure 40-21-113

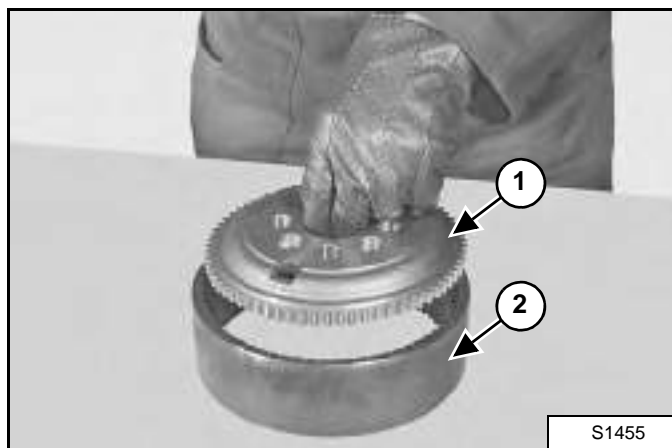

Insert the flange (Item 1) in the crown (Item 2) [Figure 40-21-113].

## AXLE AND DIFFERENTIAL (REAR) (CONT'D)

### Planetary Carrier Assembly (Cont'd)

Figure 40-21-114

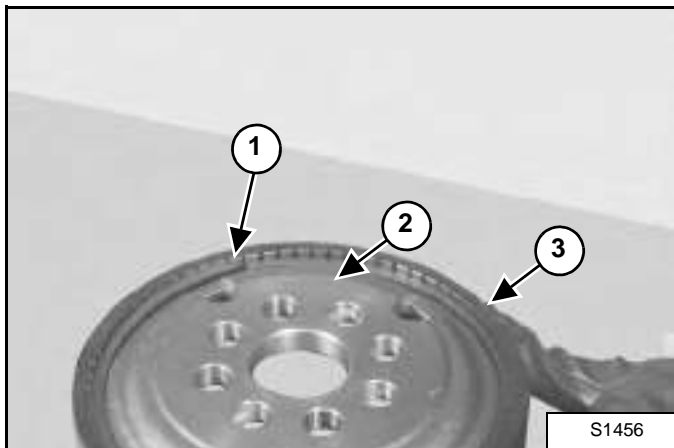

Insert the snap ring (Item 1) in order to fix the flange (Item 2) in the crown (Item 3) [Figure 40-21-114].

**NOTE:** Carefully check that the ring is properly inserted in the slot of the crown.

Figure 40-21-115

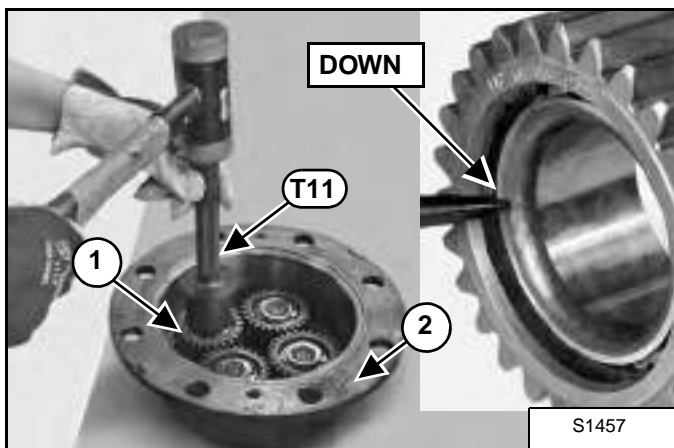

With the help of tool **T11**, insert the planet wheel gears (Item 1) into the cover (Item 2) [Figure 40-21-115]. Accurately check the orientation.

Figure 40-21-116

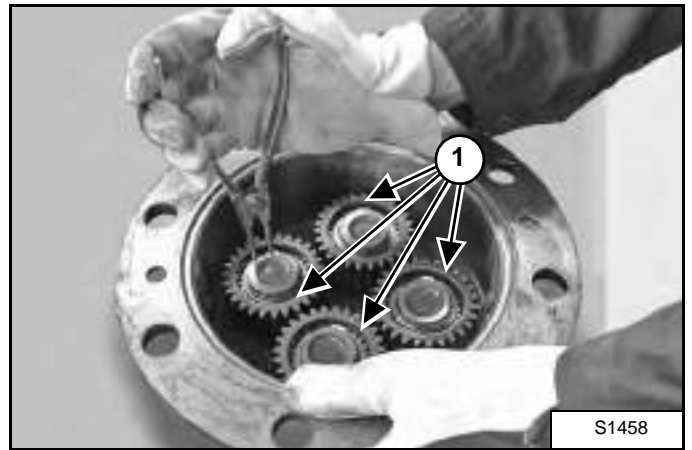

Install the four snap rings (Item 1) [Figure 40-21-116].

Figure 40-21-117

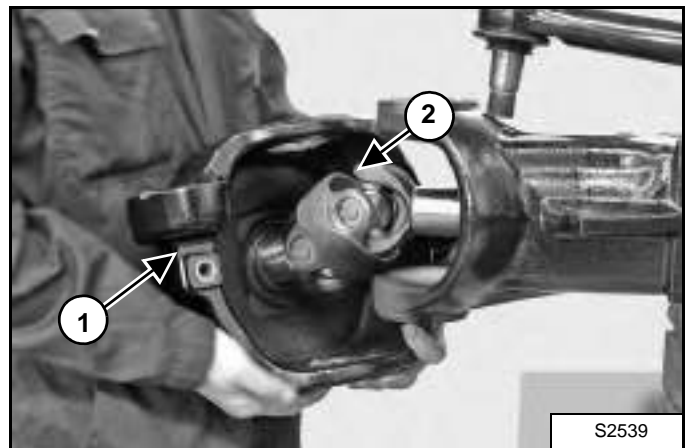

Fit the steering case (Item 1) onto the drive axle (Item 2) [Figure 40-21-117] and install the tie rods.

Connect the steering bars.

## AXLE AND DIFFERENTIAL (REAR) (CONT'D)

### Planetary Reduction Assembly (Cont'd)

Figure 40-21-118

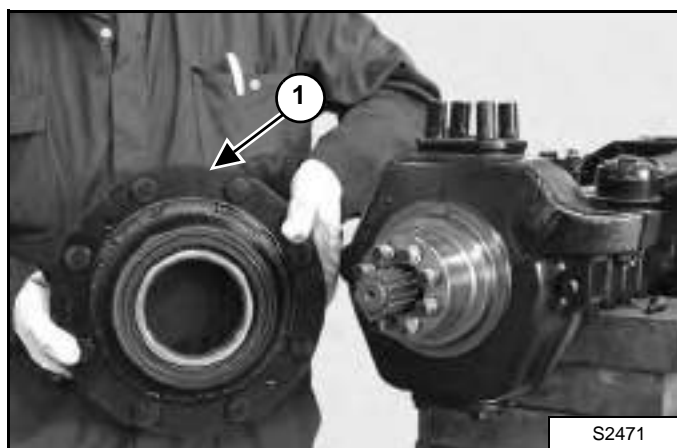

Install the hub (Item 1) [Figure 40-21-118].

Figure 40-21-119

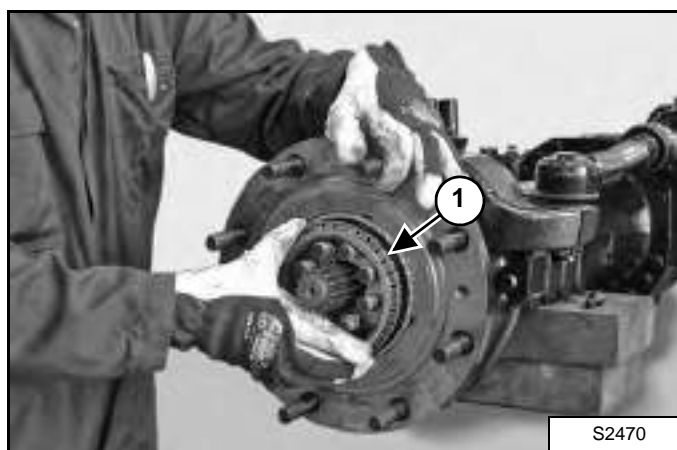

Install the external bearing (Item 1) [Figure 40-21-119].

**NOTE:** Using a plastic hammer, drive the bearing to the limit stop by lightly hammering around the edge.

Figure 40-21-120

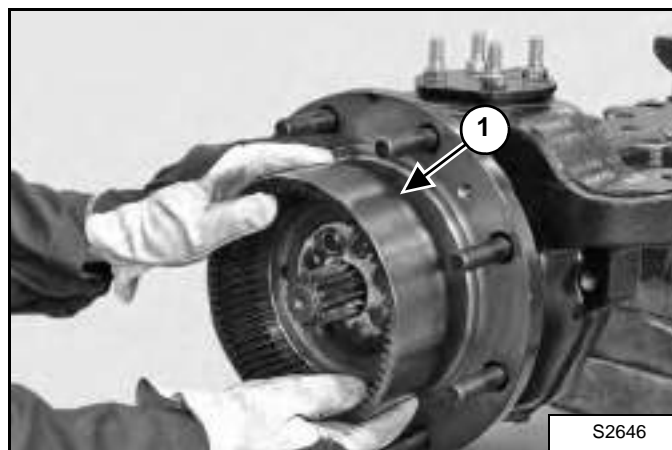

Fit the complete crown flange (Item 1) [Figure 40-21-120].

**NOTE:** In order to fasten the flange, use a plastic hammer and alternatively hammer on several equidistant points.

Figure 40-21-121

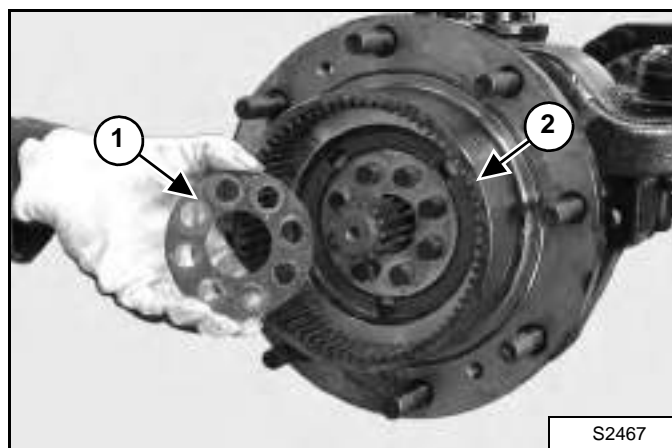

Apply silicone based grease to the surface of the flange (Item 1) which touches the crown flange (Item 2). Fit the flange (Item 1) [Figure 40-21-121].

## AXLE AND DIFFERENTIAL (REAR) (CONT'D)

### Planetary Reduction Assembly (Cont'd)

Figure 40-21-122

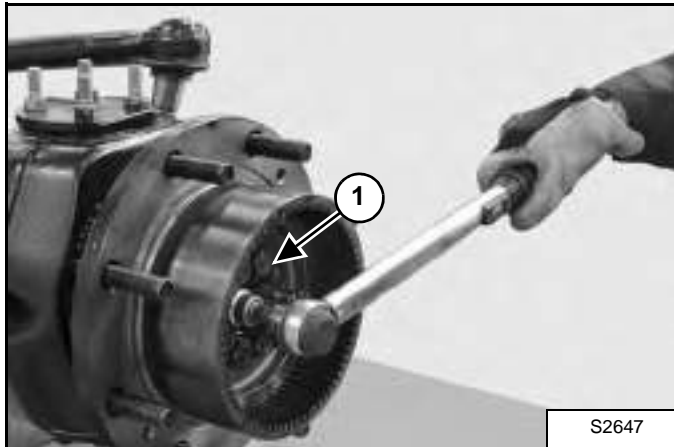

Cross tighten the nuts (Item 1) [Figure 40-21-122] in two stages.

Initial torque wrench setting: 88 ft.-lb. (120 N•m).

Final torque wrench setting: 188 - 210 ft.-lb. (255 - 285 N•m).

Figure 40-21-123

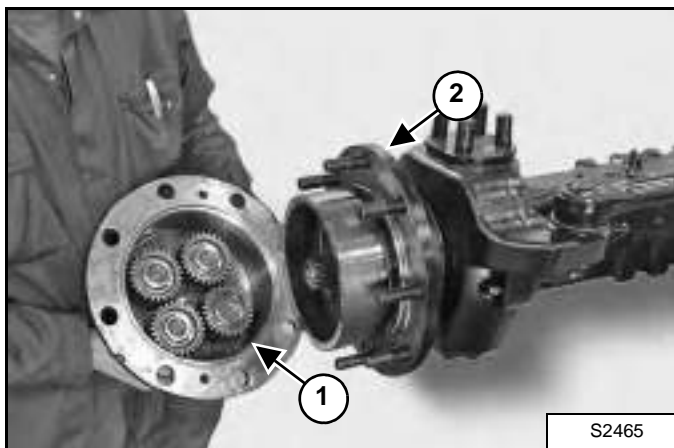

Fit the planetary carrier cover (Item 1) onto the hub (Item 2) [Figure 40-21-123].

**NOTE:** Check that the O-ring is in good condition and in position.

Figure 40-21-124

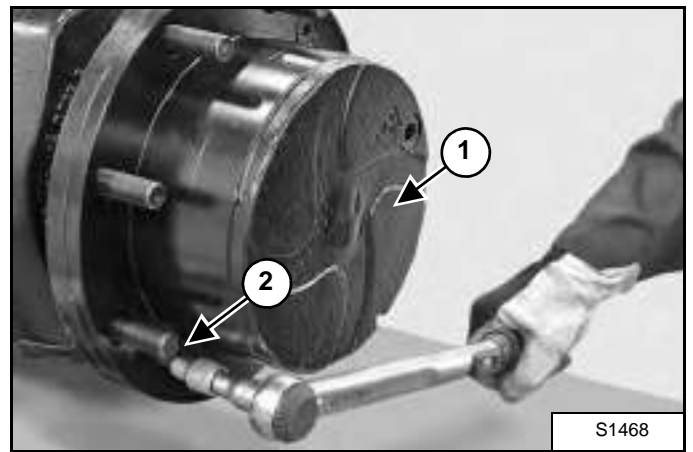

Lock the planetary carrier cover (Item 2) by tightening the screws (Item 1) [Figure 40-21-124]. Apply a torque of 30 - 37 ft.-lb. (40 - 50 N•m).

## AXLE AND DIFFERENTIAL (REAR) (CONT'D)

### Special tools

BOBCAT PN	IMAGE	DESCRIPTION	TOOL NR.
6912190		WHEEL HUB SEAL	T10
6912192		DIFFERENTIAL RING NUT	T13
6912196		DIFFERENTIAL BEARING INNER RINGS	T17
6912197		PINION RING NUT	T19 T21 T22
6912199		PINION DUMMY BEARING	T24
6912201		DUMMY PINION	T26
6912202		PINION TAIL SEAL	T27



## FRONT AXLE

### Removal

Figure 40-30-1

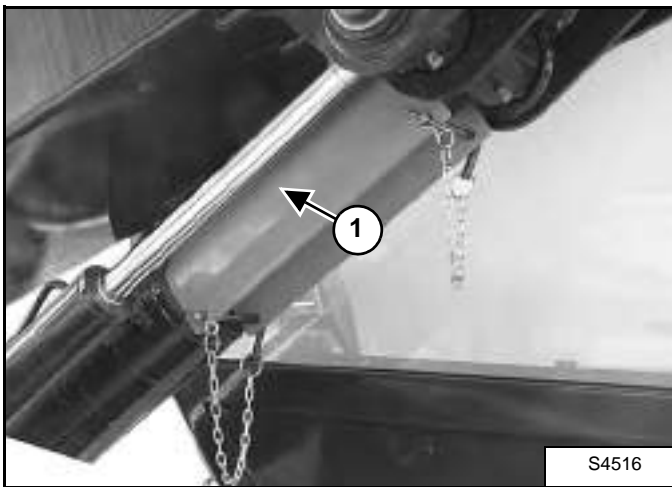

Raise the boom and install the boom stop (Item 1) [Figure 40-30-1].

Figure 40-30-2



Lift the front of the machine until the front wheels are off the ground and place jackstands under the frame as shown [Figure 40-30-2].

Place a block in front and behind the rear wheel [Figure 40-30-2].

Figure 40-30-3

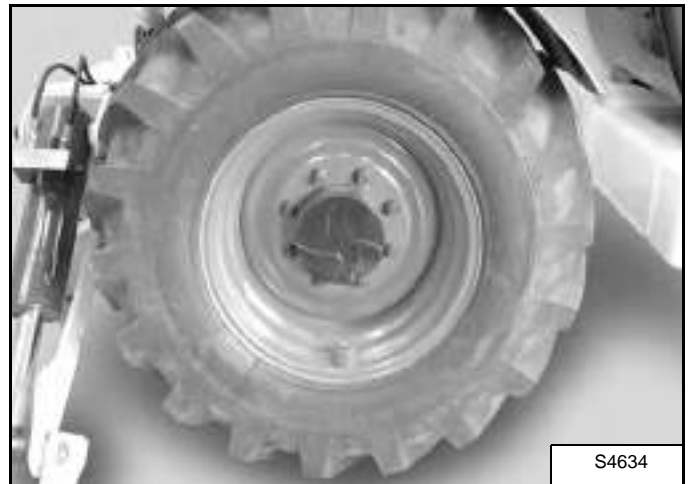

Remove the eight lug nuts and washers [Figure 40-30-3] from each front wheel.

Remove both front wheels.

Figure 40-30-4

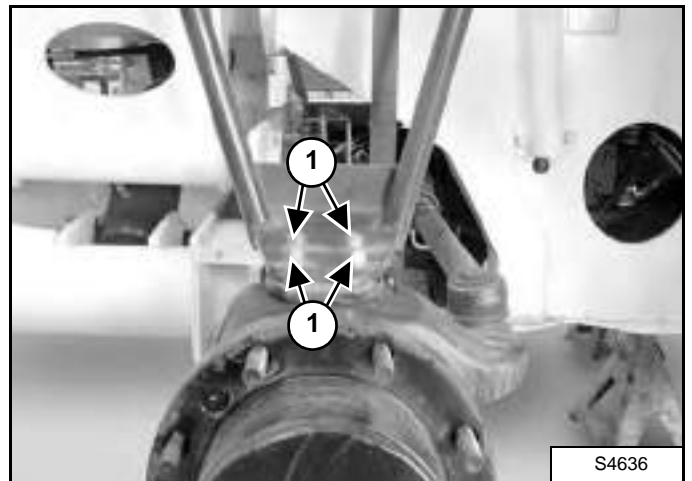

Remove the four bolts (Item 1) [Figure 40-30-4] and remove the front fenders.

Raise the two stabilizers until they are horizontal so the machine only supports on the rear wheels and the jackstands.

## FRONT AXLE (CONT'D)

### Removal (Cont'd)

Figure 40-30-5



Rotate the battery disconnect switch (Item 1) [Figure 40-30-5] to the right, to disconnect the power supply from the battery.

Drain the hydraulic reservoir (See "Replacing Hydraulic Fluid" on page 10-100-2)

Figure 40-30-6

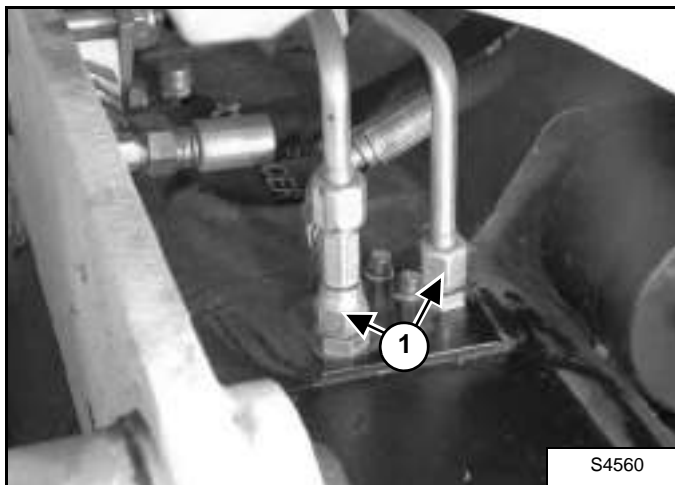

Disconnect the parking brake and service brake hydraulic tubelines (Item 1) [Figure 40-30-6] and cap them. Do this at both sides of the machine.

**NOTE:** Mark all tubelines for correct installation.

# IMPORTANT

When repairing hydrostatic and hydraulic systems, clean the work area before disassembly and keep all parts clean. Always use caps and plugs on hoses, tubelines and ports to keep dirt out. Dirt can quickly damage the system.

I-2003-0888

Figure 40-30-7

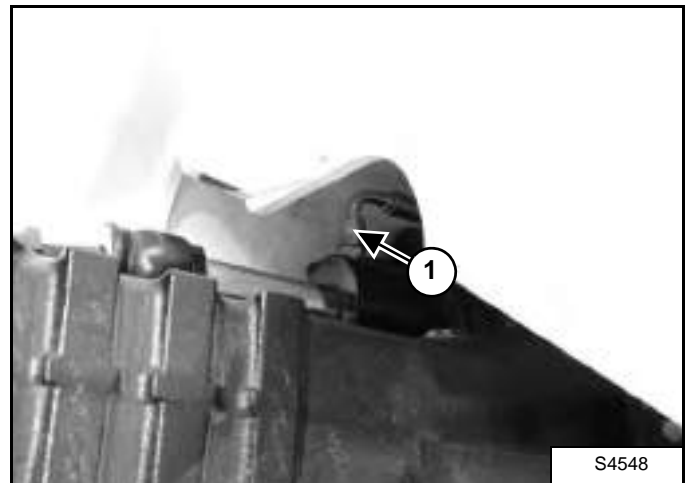

Disconnect the hydraulic tubeline (Item 1) [Figure 40-30-7] from the steering cylinder. Cap the tubeline.

Figure 40-30-8

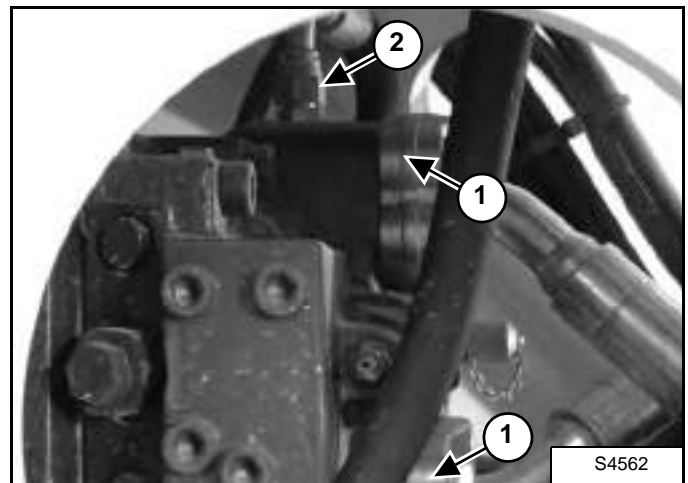

Disconnect the two hydraulic tubelines (Item 1) from the hydrostatic motor by removing the four bolts. Also disconnect the drain hydraulic tubeline on top of the hydrostatic motor (Item 2) [Figure 40-30-8]. Cap all the tubelines and couplings.

## FRONT AXLE (CONT'D)

### Removal (Cont'd)

Figure 40-30-9

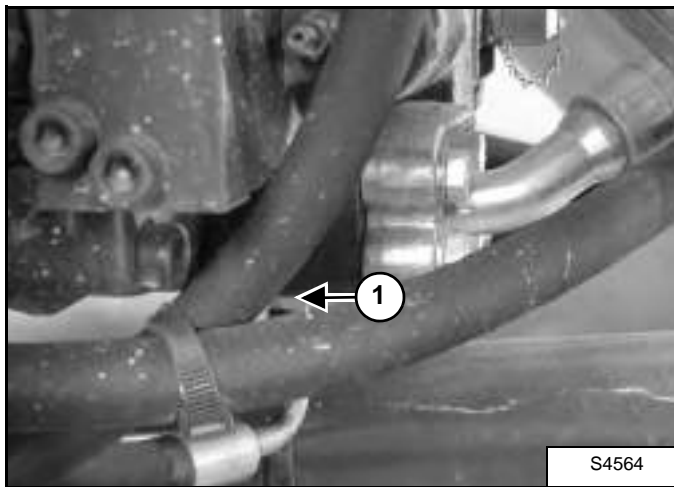

Disconnect the drain hydraulic tubeline (Item 1) [Figure 40-30-9] from the bottom of the hydrostatic motor and cap it.

Figure 40-30-10

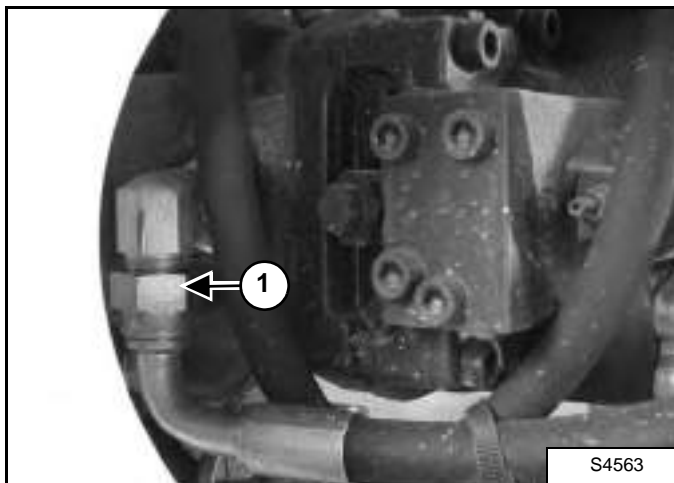

Disconnect the hydraulic tubeline (Item 1) [Figure 40-30-10] from the hydrostatic motor and cap it. Also cap the coupling.

Figure 40-30-11

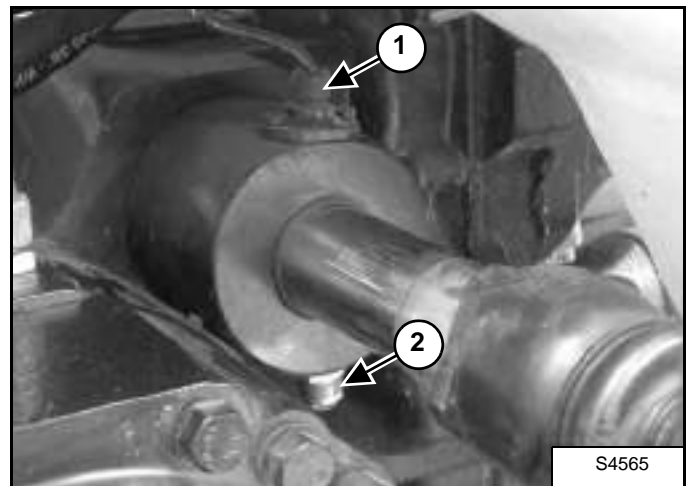

Disconnect the center position sensor (Item 1) and the hydraulic tubeline (Item 2) [Figure 40-30-11] from the steering cylinder.

Figure 40-30-12

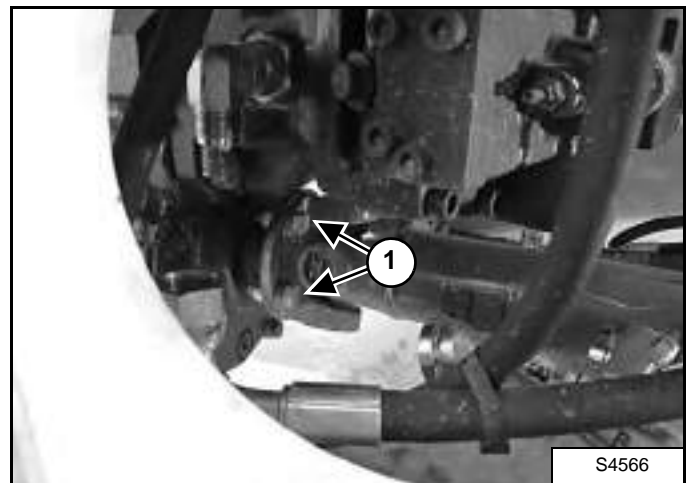

Disconnect the drive shaft (Item 1) [Figure 40-30-12] from the front axle by removing the four screws.

## FRONT AXLE (CONT'D)

### Removal (Cont'd)

Figure 40-30-13

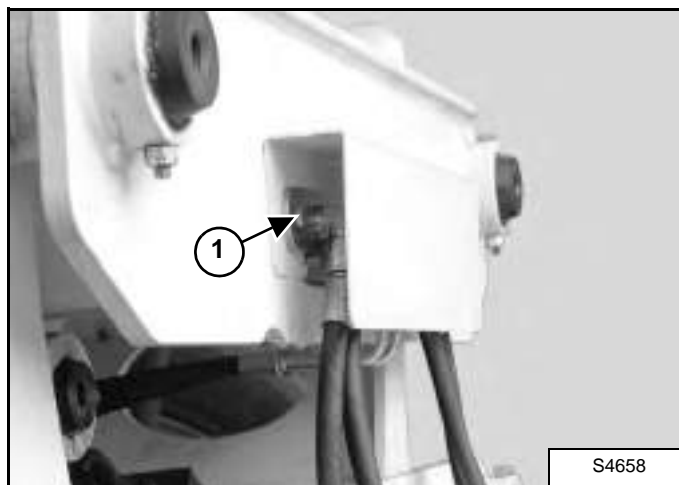

Remove the cover (Item 1) by loosening the two screws (Item 2) [Figure 40-30-13].

Figure 40-30-14

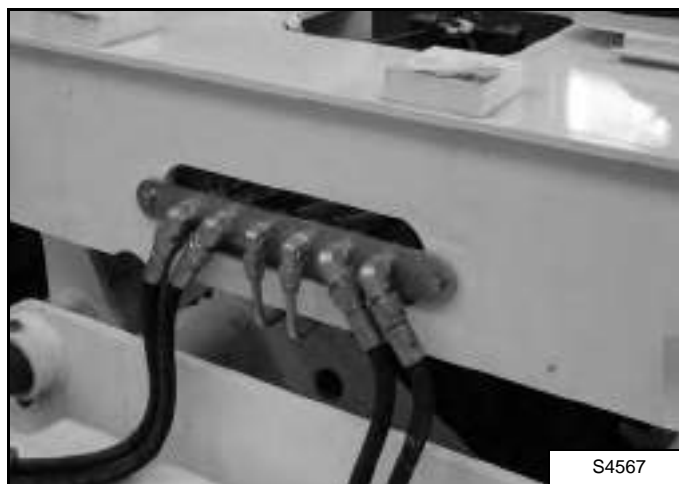

Disconnect the six hydraulic tubelines [Figure 40-30-14] from the front of the machine. Cap the tubelines and the couplings.

**NOTE:** Mark all tubelines for correct installation.

Figure 40-30-15

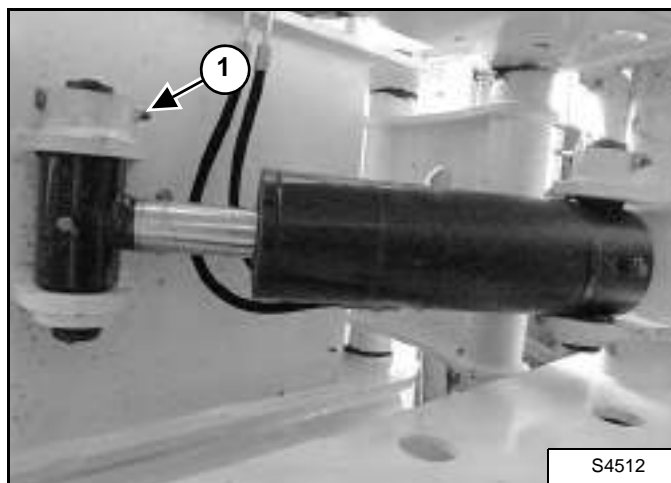

Disconnect the frame levelling cylinder by removing the screw and nut (Item 1) [Figure 40-30-15] and remove the pivot pin.

Figure 40-30-16

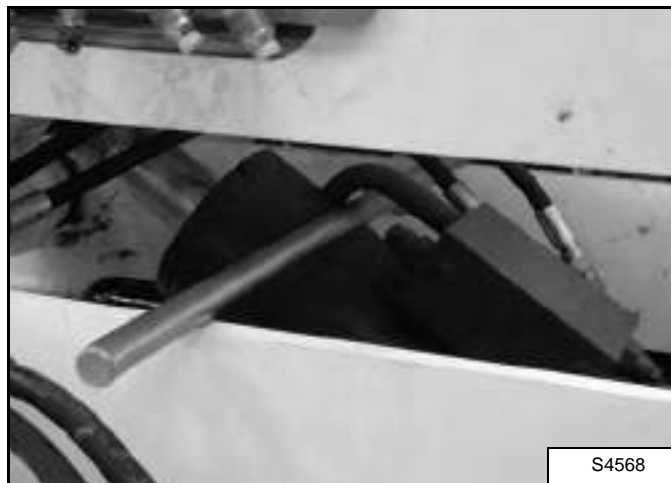

**NOTE:** Before disconnecting the cylinder, make sure the cylinder is kept up by means of a bar [Figure 40-30-16].

Make sure the stabilizer frame is well supported. Use a fork-lift truck to support the frame.

## IMPORTANT

If the capacity of the fork-lift truck is too low to carry the front of the machine, first remove the front weight from the machine (T40170 only).

## FRONT AXLE (CONT'D)

### Removal (Cont'd)

Figure 40-30-17

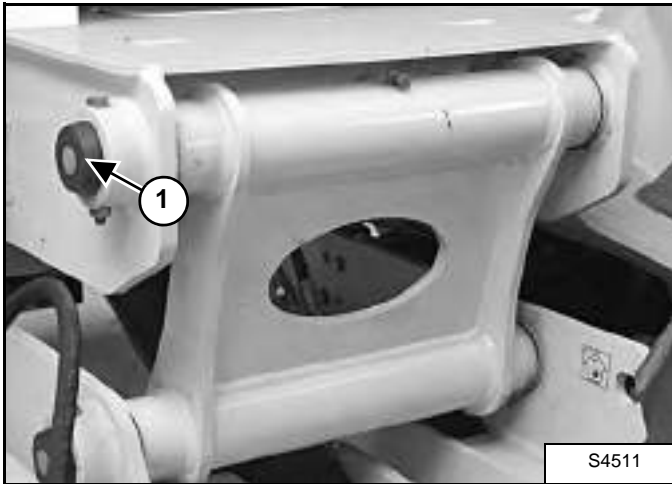

Remove the upper pivot pin (Item 1) [Figure 40-30-17] on the left side. Repeat for the right side.

## WARNING

If the stabilizer frame is not well supported it will fall down when removing the two pivot pins.

Figure 40-30-18

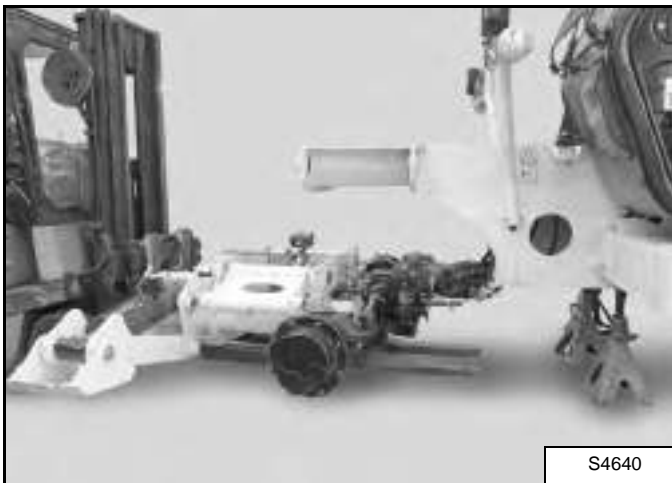

Carefully remove the stabilizer frame from the machine by lowering it and pulling it back [Figure 40-30-18].

**NOTE:** Be careful when putting down the front of the machine. Make sure no tubelines or hoses are distorted.

Figure 40-30-19

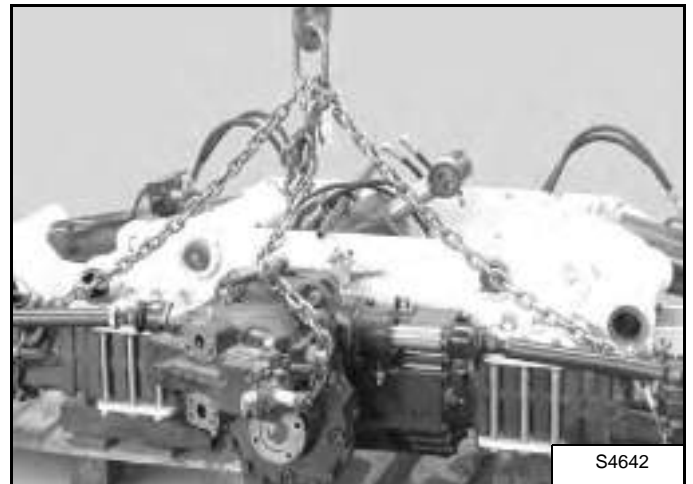

Connect the front axle to a 3-point chain as shown in [Figure 40-30-19].

Figure 40-30-20

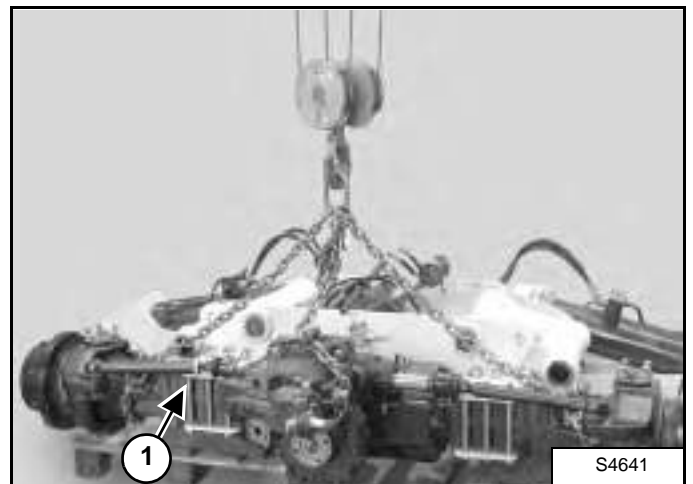

Remove the 12 front axle mounting bolts and nuts (Item 1) [Figure 40-30-20].

**Assembly:** Tighten the bolts to 350 N•m.

---

## FRONT AXLE (CONT'D)

### Removal (Cont'd)

Figure 40-30-21

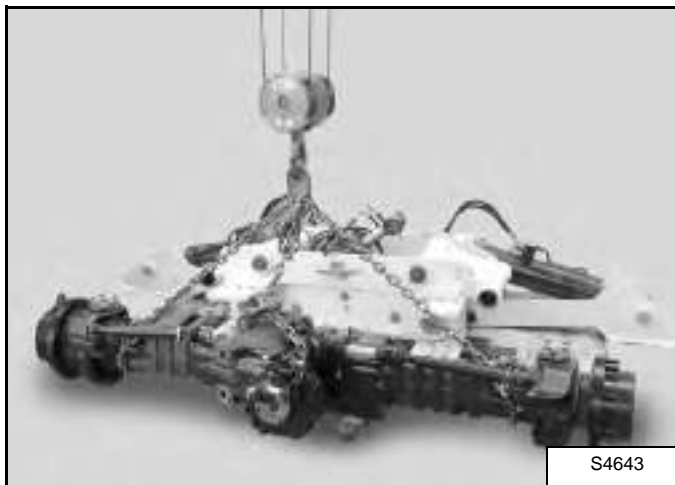

Remove the front axle from the stabilizer frame by means of the 3-point chain [Figure 40-30-21].

## AXLE TOE-IN

### Adjustment

The axle is removed from the machine for photo clarity, but this procedure may be completed with the axle installed in the machine.

Turn the steering wheel until the steering cylinder rod is positioned in the center. Measure the exposed part of the cylinder rod on each side of the cylinder housing making sure they are the same length.

Figure 40-40-1

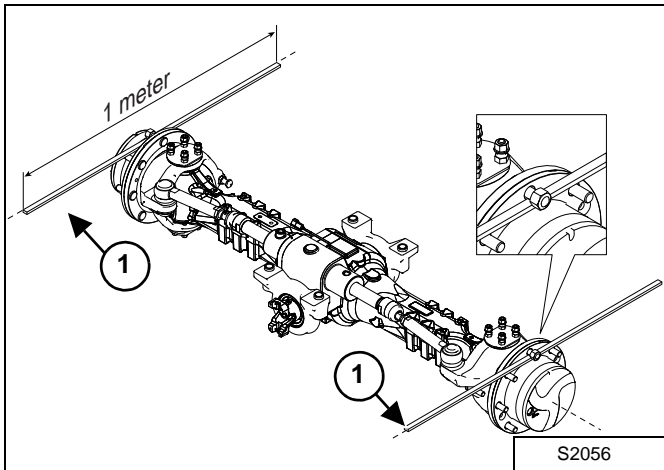

Install two identical, straight bars (Item 1) [Figure 40-40-1] onto the wheel hub and secure them using lug nuts.

**NOTE:** The two bars must be perpendicular to the ground.

Figure 40-40-2

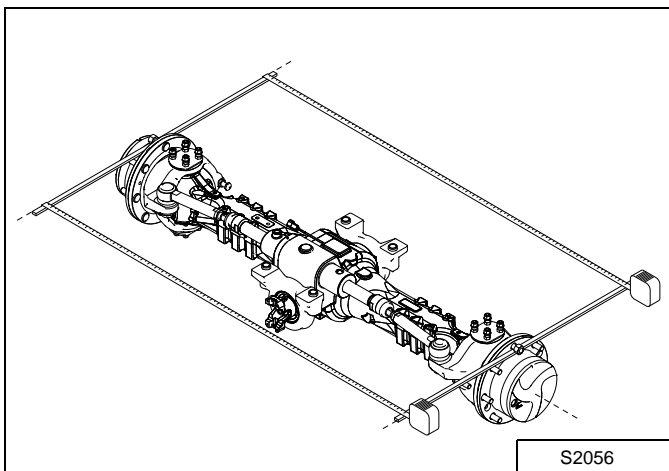

Measure the distance between the ends of the two bars [Figure 40-40-2]. The measurement must be equal.

Figure 40-40-3

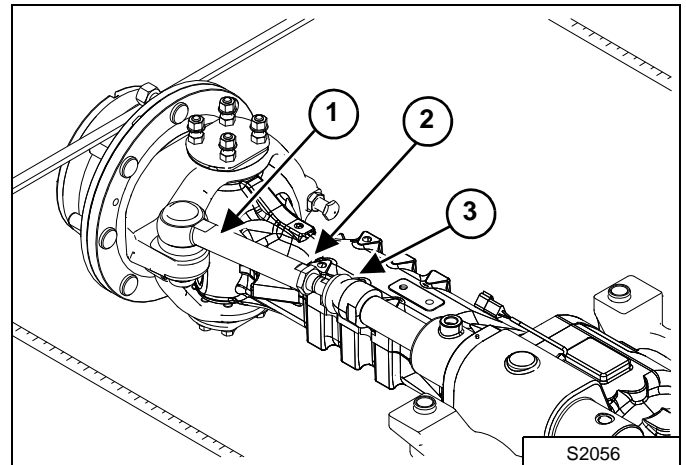

If measurement is not the same, adjust both tie rod ends (Item 1) by loosening or tightening the track rods (Item 2) [Figure 40-40-3] of both tie rods until the measurement is the same.

Tighten the nut (Item 3) [Figure 40-40-3] to 221 ft.-lb. (300 N•m) torque.





## PARKING BRAKE

### Releasing The Brake For Towing

Block all four wheels to prevent the machine from moving once the parking brake is released.

Locate the six brake release bolts (three per side) on the front axle.

Figure 40-50-1

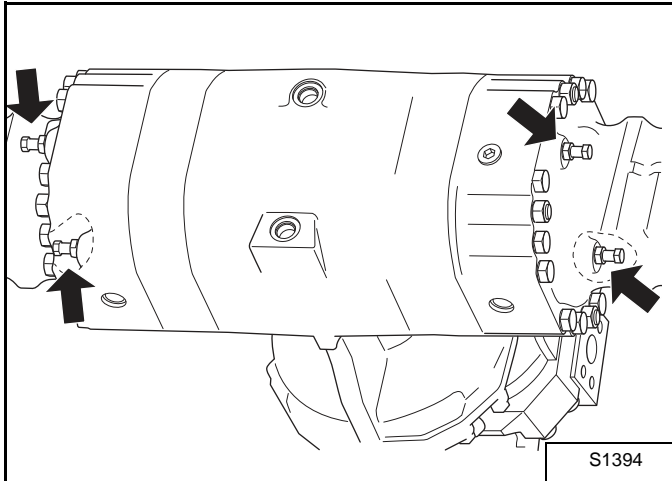
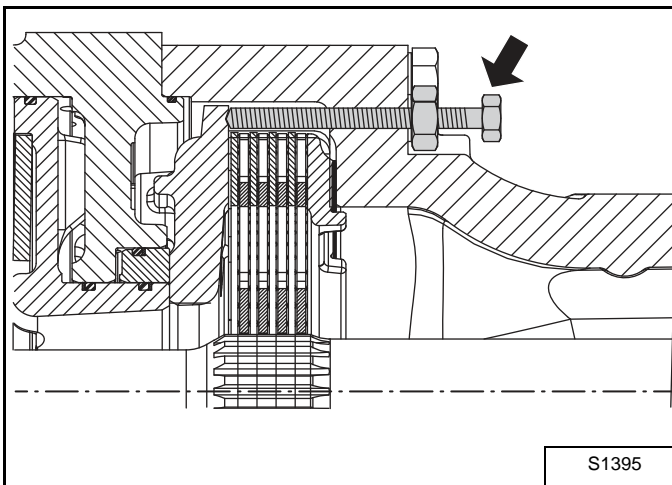
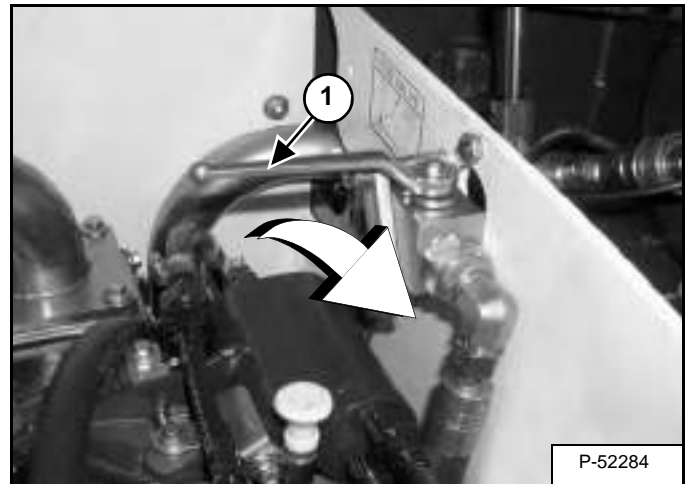

Figure 40-50-2



Alternately turn the brake release bolts [Figure 40-50-1] "IN" (clockwise) 1/2 turn each until you feel resistance. Continue to turn each release bolt in equally 1/2 turn for a total of approximately 5 complete turns.

Figure 40-50-3



Locate the tow valve (Item 1) [Figure 40-50-3], turn counterclockwise 90° to the towing position.

The machine is now ready to be towed.

## PARKING BRAKE (CONT'D)

### Re-Activating The Brake

Block all four wheels to prevent the machine from moving.

Locate the six brake release bolts (three per side) on the front axle.

Figure 40-50-4

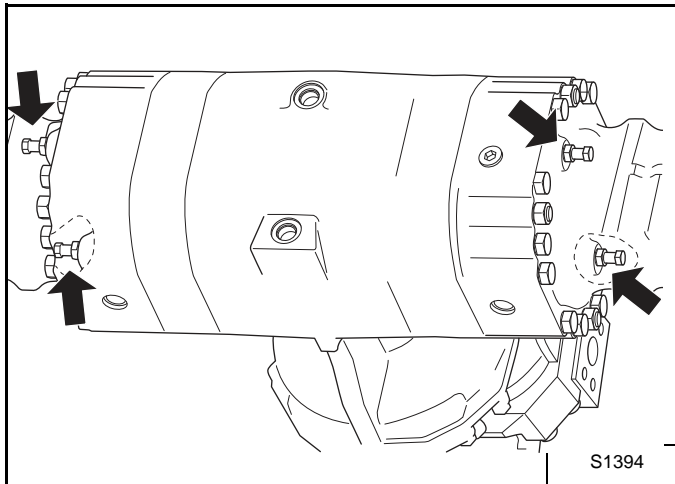
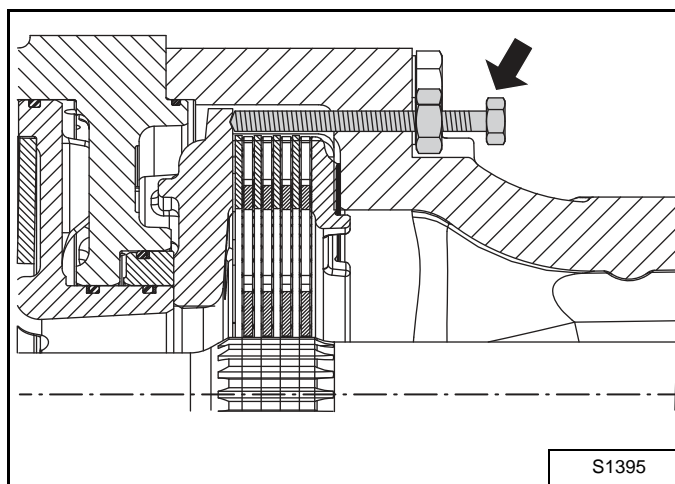
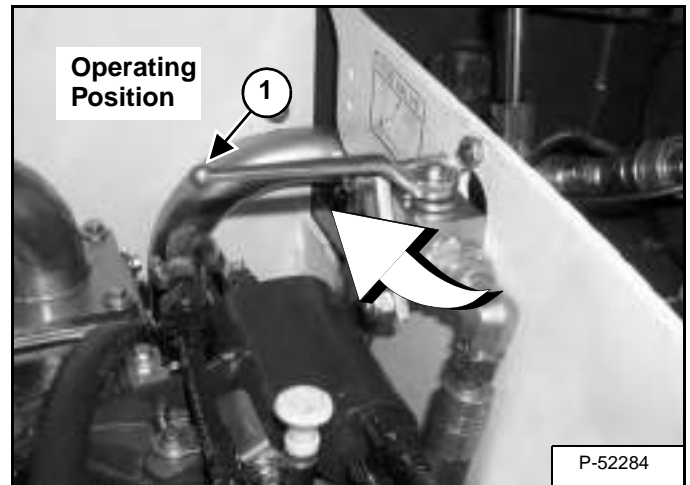

Figure 40-50-5



Alternately turn the brake release bolts [Figure 40-50-4] "OUT" (counterclockwise) 1/2 turn until the torque drops off sharply. Continue to turn each release bolt out equally 1/2 turn until the brake release bolt presses against the bolt housing. After the brake release bolt is touching the bolt housing turn each brake release bolt "IN" (clockwise) a 1/4 turn.

Figure 40-50-6



Locate the tow valve (Item 1) [Figure 40-50-6] under the hood, turn clockwise 90° to the operating position.

The parking brake is now re-activated.

**! WARNING**

The vehicle will not be able to break until the screws are returned to their original position.

## STEERING ANGLE ADJUSTMENT

### Adjustment

The axle is removed from the machine for photo clarity, but this procedure may be completed with the axle installed in the machine.

Figure 40-60-1

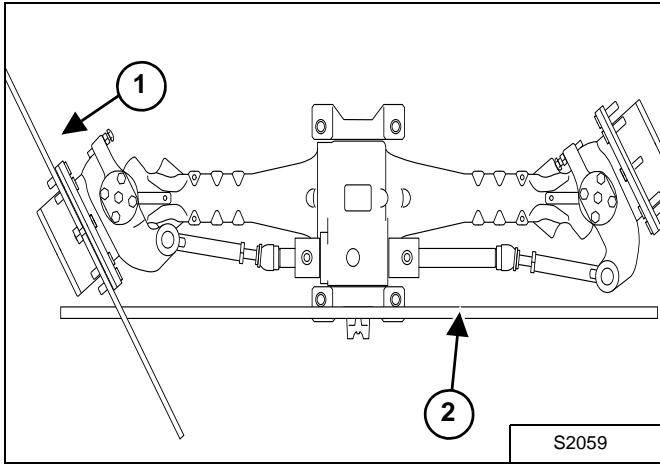

Install a straight bar (Item 1) onto the wheel hub and secure using lug nuts. Turn the steering wheel completely to one side. Place a straight bar (Item 2) [Figure 40-60-1] on the pinion shaft.

Figure 40-60-2

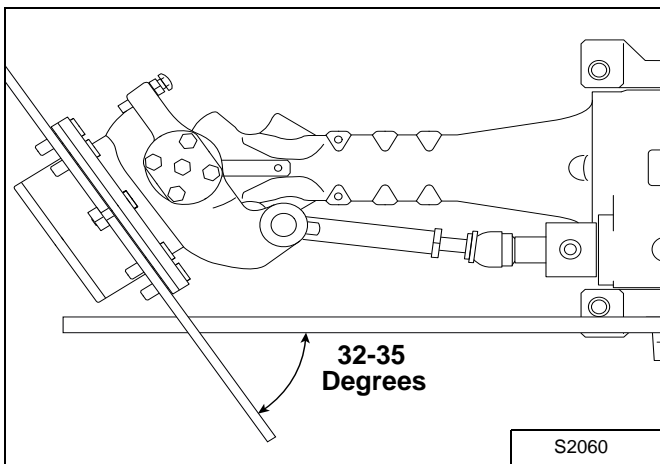

Use an angle gauge, to obtain a reading of 32-35 degrees [Figure 40-60-2].

Figure 40-60-3

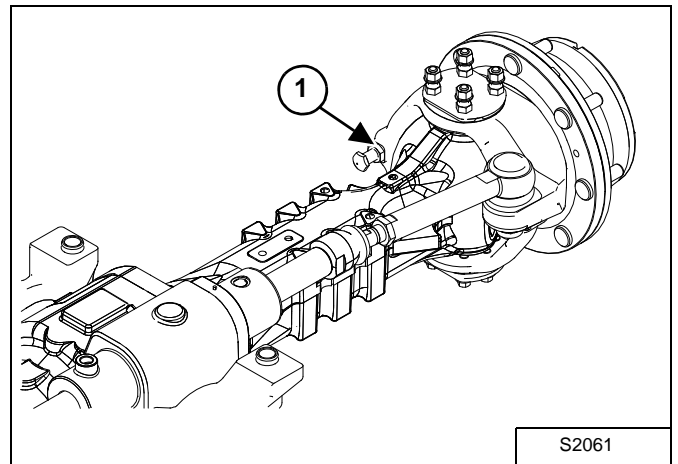

Adjust the stop (Item 1) [Figure 40-60-3] as needed. Tighten the lock nut to 110 ft.-lb. (150 N•m) torque.

Figure 40-60-4

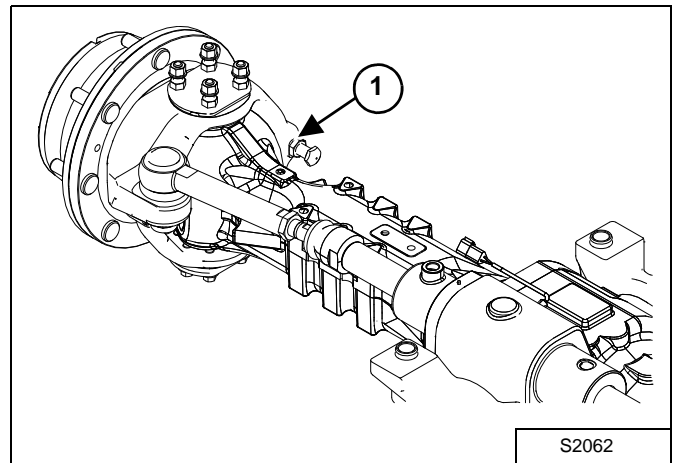

Turn the steering wheel completely to the other side [Figure 40-60-4] and repeat above procedure.



**Bobcat®**

## DRIVESHAFT

### Removal And Installation

Figure 40-70-5

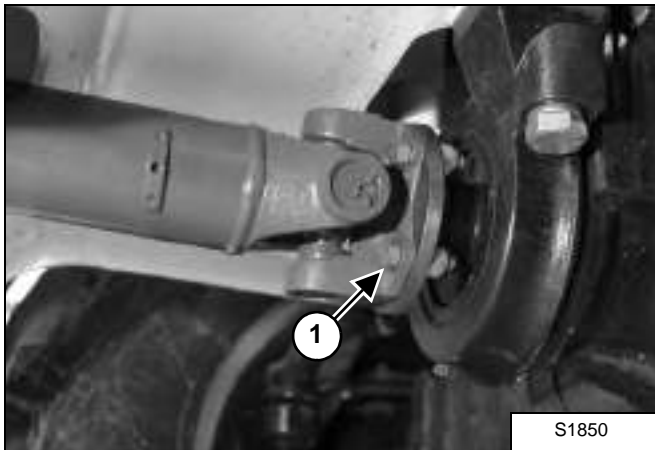

Remove the four drive shaft mounting bolts (Item 1) [Figure 40-70-5] from each end of the drive shaft.

Figure 40-70-6

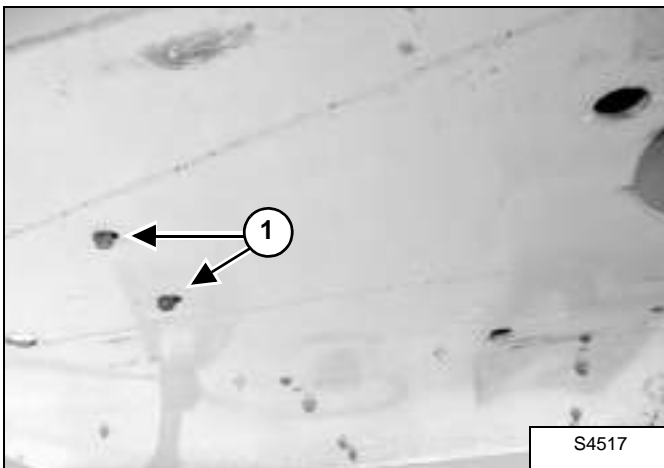

Remove the intermediate drive shaft support by removing the two bolts (Item 1) [Figure 40-70-6] on the bottom side of the machine frame.

Figure 40-70-7

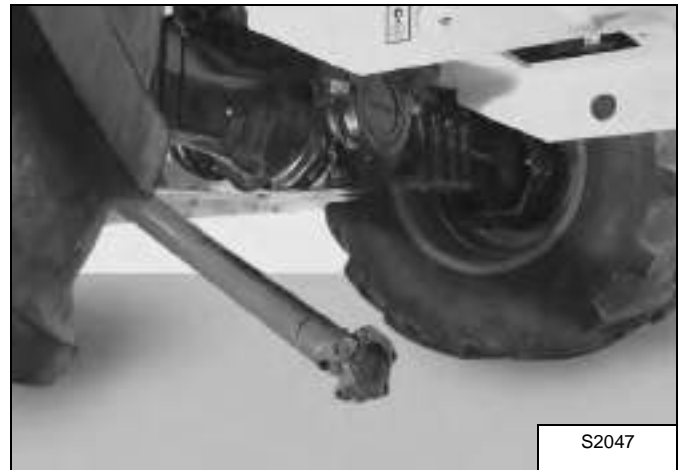

Remove the drive shaft out the rear of the machine [Figure 40-70-7].

Figure 40-70-8

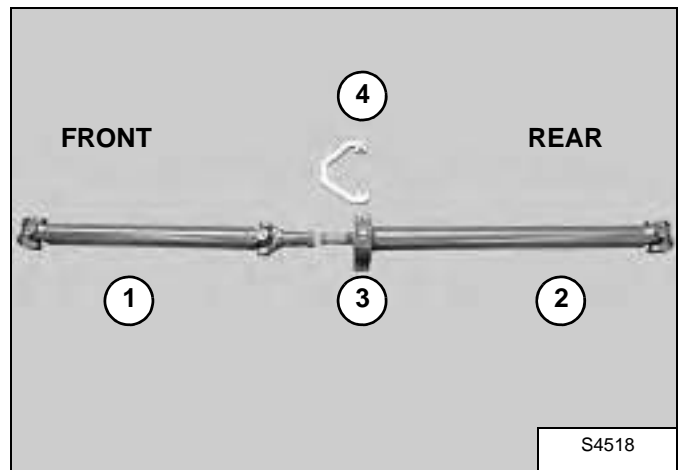

The drive shaft assembly consists of the following parts: front shaft (Item 1), rear shaft (Item 2), intermediate support (contains a bearing and a damper) (Item 3), threaded bracket (Item 4) [Figure 40-70-7].



**Bobcat®**

## SERVICE BRAKE

### Description

There are two bleed screws located on each side of the front axle differential housing.

Air trapped in the brake lines may cause a spongy feel and/or delayed activation of the service brake.

Use the following procedure to remove air from the brake circuit.

### Bleeding The Brake Circuit

Lift and block the machine. (See "LIFTING AND BLOCKING THE TELESCOPIC HANDLER" on page 10-10-1)

**NOTE: Position the jack stands to allow starting the machine and driving the wheels.**

On machines with frame leveling the bleed screws are accessible from both sides of the front axle.

Figure 40-80-1

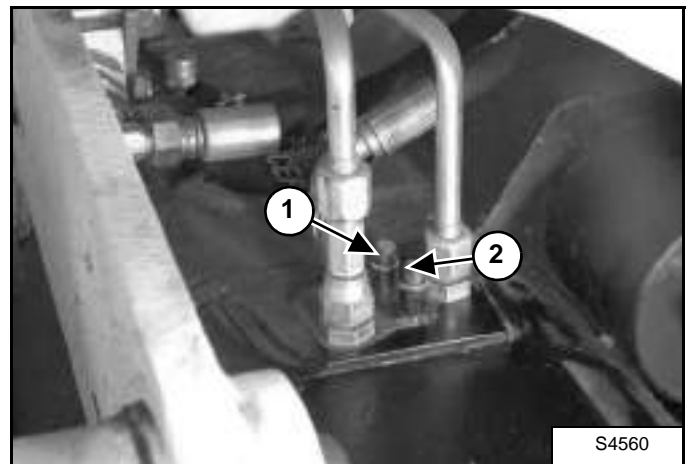
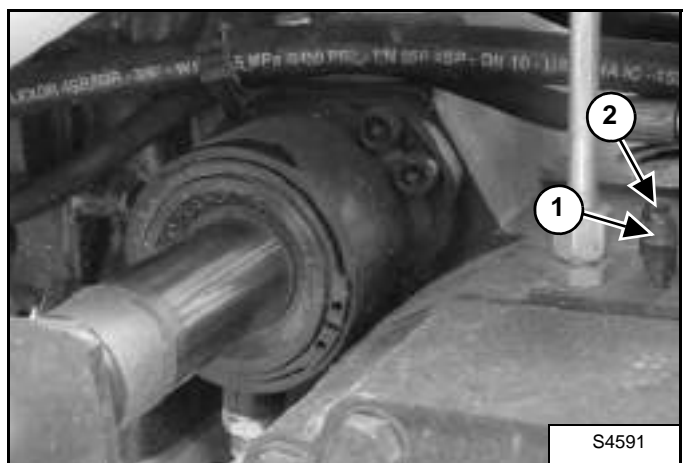

Figure 40-80-2



Remove the caps and loosen the four bleed screws (Items 1 & 2) [Figure 40-80-1] & [Figure 40-80-2].

**NOTE: Hydraulic fluid will be forced from the bleed screws during the following procedure:**

With the aid of an assistant, start the engine, lower the restraint bar and apply the service brake until a continuous stream of clean hydraulic fluid, with no air, flows from the inside bleed screws (Item 1) [Figure 40-80-1] & [Figure 40-80-2]. Stop the engine and tighten the two inside bleed screws.

Start the machine, engage the hydro stat and turn the wheels until a continuous stream of clean hydraulic fluid, with no air, flows from the outside bleed screws (Item 2) [Figure 40-80-1] & [Figure 40-80-2]. Stop the engine and tighten the two outside bleed screws.

Lower the machine and test for proper brake operation.



**Bobcat®**



## REAR AXLE

### Removal

Position the machine on the work surface.

# ! WARNING

Hydraulic fluid escaping under pressure can have sufficient force to enter a person's body by penetrating the skin. This can cause serious injury and possible death if proper medical treatment by a physician familiar with this injury is not received immediately.

W-2145-0290

Figure 40-90-1



Rotate the battery disconnect switch (Item 1) [Figure 40-90-1] to the right, to disconnect the power supply from the battery.

Figure 40-90-2



Lift the rear of the machine and place jack stands under the frame as shown in [Figure 40-90-2].

Place a block in front and behind the front wheel.

Figure 40-90-3

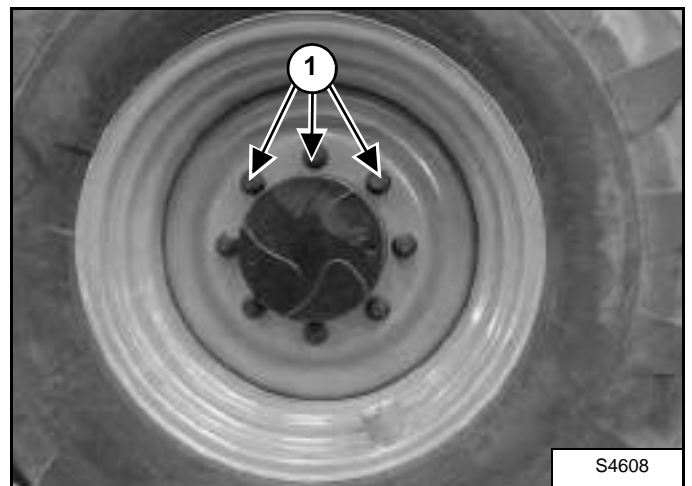

Remove the eight lug nuts and washers (Item 1) [Figure 40-90-3] from each rear wheel.

Remove both rear wheels.

**Installation:** Tighten the nuts to 221 ft.-lb. (300 N•m) torque.

## REAR AXLE (CONT'D)

### Removal (Cont'd)

Figure 40-90-4

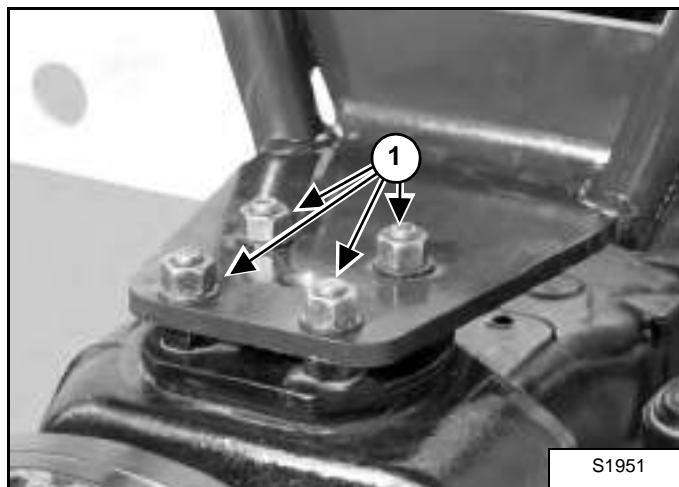

Remove the four bolts (Item 1) [Figure 40-90-4] and remove the rear fenders.

Figure 40-90-5

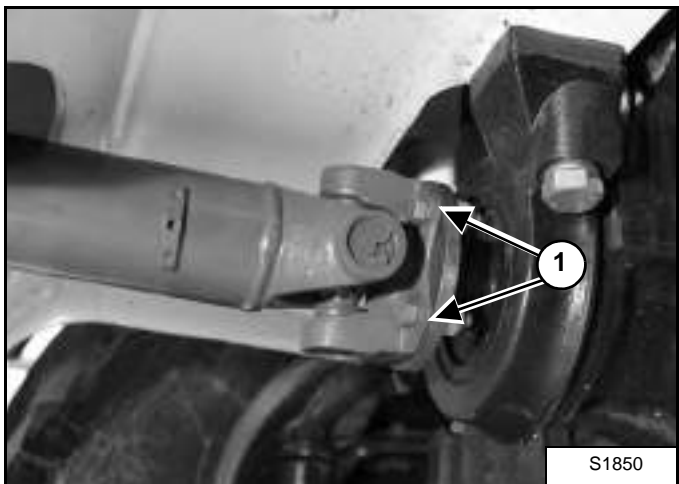

Remove the four bolts (Item 1) [Figure 40-90-5] and nuts from the driveshaft.

**Installation:** Tighten the bolts to 87 ft.-lb. (118 N•m) torque.

**NOTE:** Mark all hoses for correct installation.

# IMPORTANT

When repairing hydrostatic and hydraulic systems, clean the work area before disassembly and keep all parts clean. Always use caps and plugs on hoses, tubelines and ports to keep dirt out. Dirt can quickly damage the system.

I-2003-0888

Remove the two hoses from the rear steering cylinder.

Figure 40-90-6

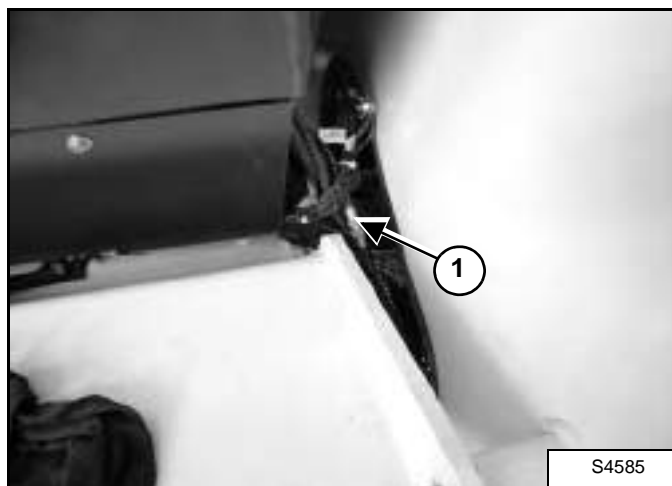

Unplug the two electrical connectors (Item 1) [Figure 40-90-6].

Figure 40-90-7

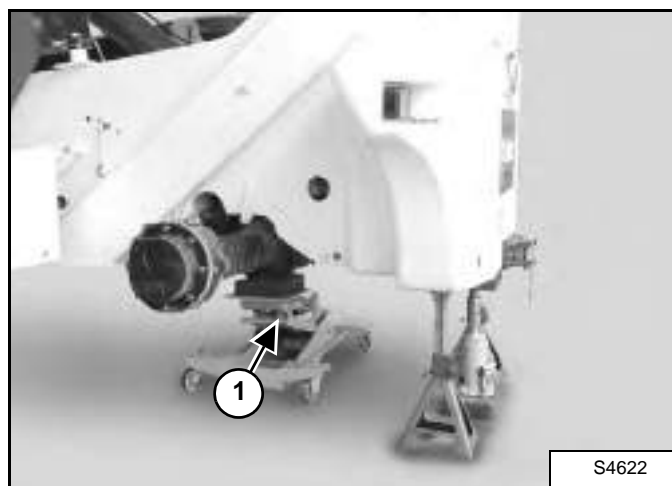

Install two jack stands and a floorjack (Item 1) [Figure 40-90-7] under the axle.

## REAR AXLE (CONT'D)

### Removal (Cont'd)

Figure 40-90-8

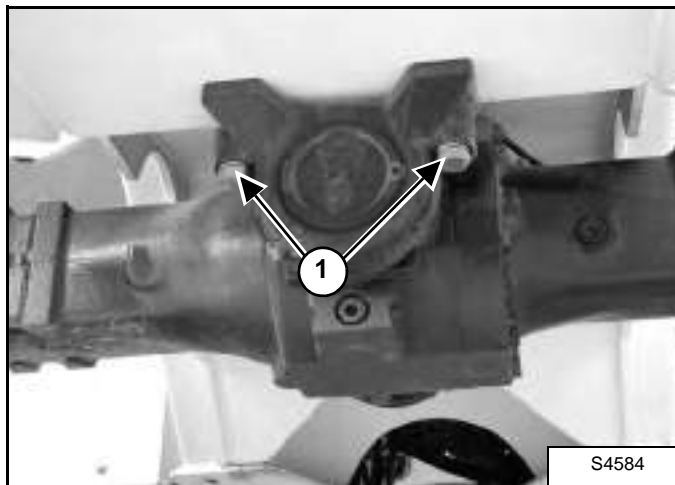

Remove the four bolts (Item 1) [Figure 40-90-8] from the rear axle mount bracket.

Figure 40-90-9

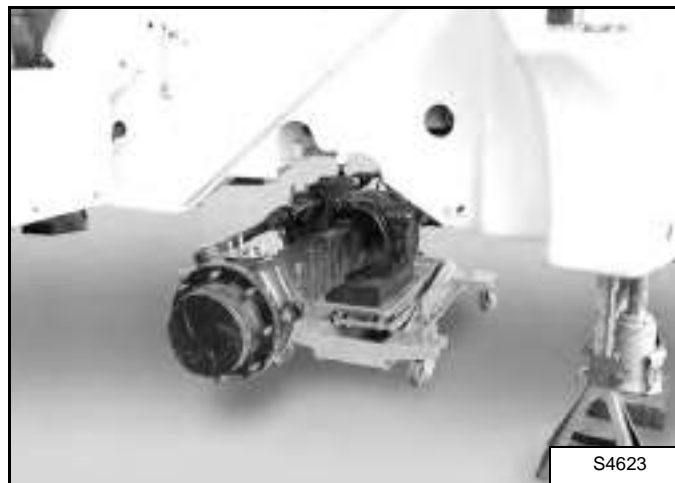

Remove the jack stands from the axle.

Have an assistant balance the axle on the floor jack and lower the floor jack slowly. Roll the axle out from under the frame [Figure 40-90-9].



**Bobcat®**

---

## MAIN FRAME

AIR INTAKE COWLING . . . . .	50-71-1
Removal And Installation. . . . .	50-71-1
BOOM ASSEMBLY . . . . .	50-30-1
Removal And Installation. . . . .	50-30-1
BOOM TRAY. . . . .	50-160-1
Removal And Installation. . . . .	50-160-1
CHAIN CHECKING AND ADJUSTING PROCEDURE. . . . .	50-170-1
Checking The Tension Of The Telescoping Chains Of The T40140 / T40170 . . . . .	50-170-1
DASH COVER / STEERING COLUMN COVER. . . . .	50-130-1
Removal And Installation. . . . .	50-130-1
END BOOM . . . . .	50-40-1
Installation . . . . .	50-40-3
Removal . . . . .	50-40-1
ENGINE COVER . . . . .	50-70-1
Gas Cylinder Removal And Installation. . . . .	50-70-1
Removal And Installation. . . . .	50-70-1
FENDER. . . . .	50-110-1
Removal And Installation. . . . .	50-110-1
FRONT WEIGHT . . . . .	50-120-1
Removal And Installation. . . . .	50-120-1
FUEL TANK . . . . .	50-80-1
Removal And Installation. . . . .	50-80-1
INTERMEDIATE BOOM . . . . .	50-150-1
Installation of the First Intermediate Boom (T40170 & T40140) . .	50-150-2
Installation of the Second Intermediate Boom (T40170). . . . .	50-150-4
Removal of the First Intermediate Boom (T40170 & T40140). . . .	50-150-1
Removal of the Second Intermediate Boom (T40170) . . . . .	50-150-3
JOYSTICK PANEL . . . . .	50-140-1
Removal And Installation. . . . .	50-140-1
OPERATOR CAB . . . . .	50-10-1
Removal and Installation . . . . .	50-10-1

MAIN FRAME

Continued On Next Page

---

## MAIN FRAME (CONT'D)

OPERATOR SEAT .....	50-20-1
Removal And Installation .....	50-20-1
QUICK TACH .....	50-90-1
Removal And Installation .....	50-90-1
REAR WEIGHTS .....	50-100-1
Removal And Installation .....	50-100-1
STABILIZER FRAME .....	50-180-1
Removal .....	50-180-1
WEAR PADS (FRONT) .....	50-50-1
Installation .....	50-50-2
Removal .....	50-50-1
WEAR PADS (REAR) .....	50-60-1
Installation .....	50-60-1
Removal .....	50-60-1

## OPERATOR CAB

### Removal and Installation

Figure 50-10-1

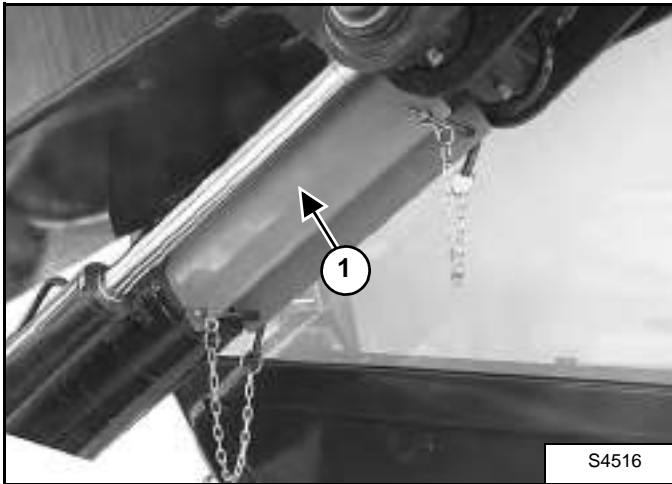

Raise the boom and install the boom stop (Item 1) [Figure 50-10-1].

Stop the engine.

Relieve hydraulic pressure.

Figure 50-10-2

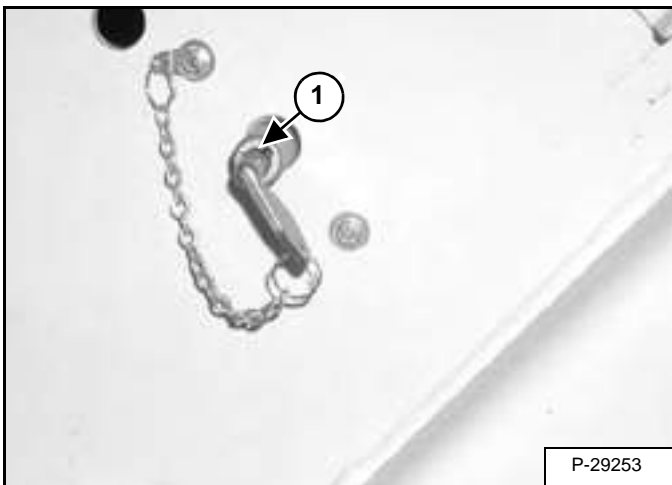

Rotate the battery disconnect switch (Item 1) [Figure 50-10-2] to the right, to disconnect the power supply from the battery.

Figure 50-10-3

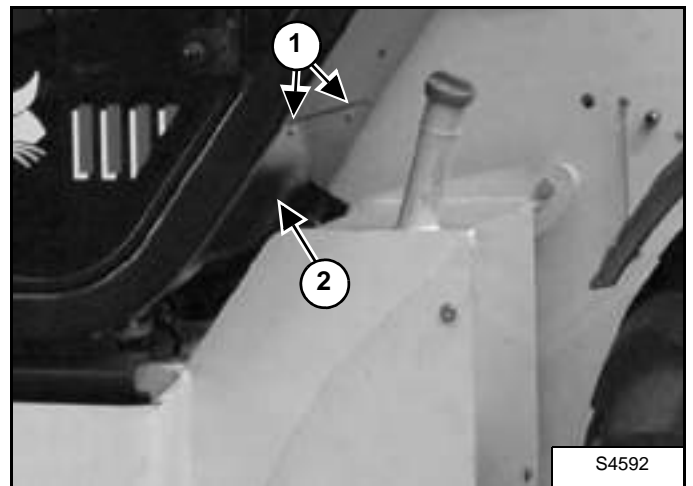

Remove the three screws (Item 1) from the access cover (Item 2) [Figure 50-10-3] located on the back of the canopy.

Remove the access cover.

**NOTE: Mark all hoses and electrical connectors for correct installation.**

Figure 50-10-4

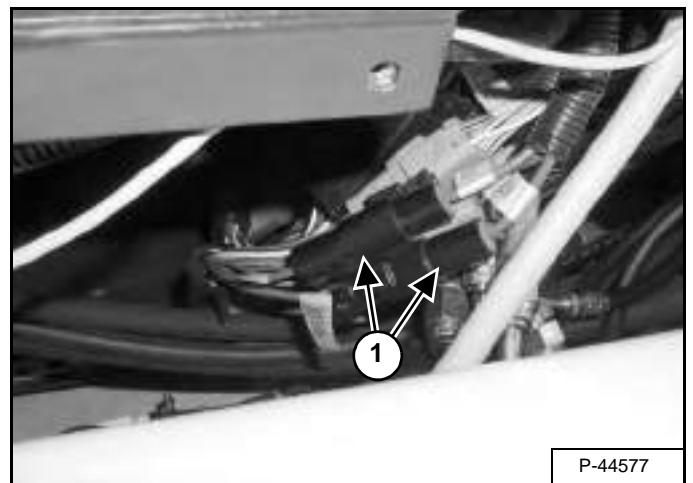

Unplug the two electrical connectors (Item 1) [Figure 50-10-4].

## OPERATOR CAB (CONT'D)

### Removal and Installation (Cont'd)

Figure 50-10-5

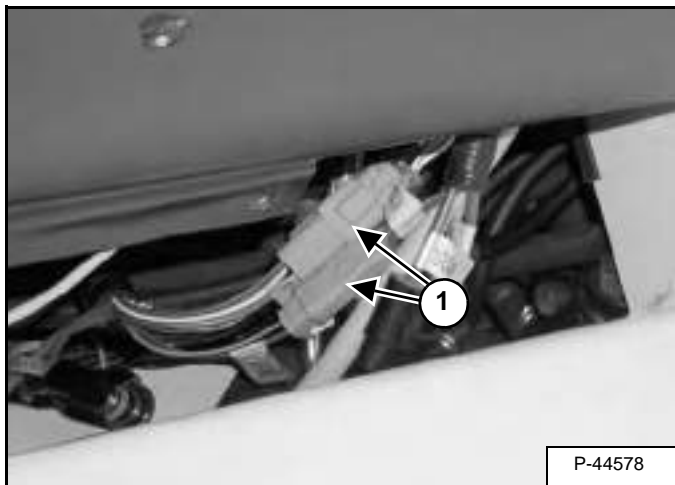

Unplug the four electrical connectors (Item 1) [Figure 50-10-5].

Figure 50-10-6

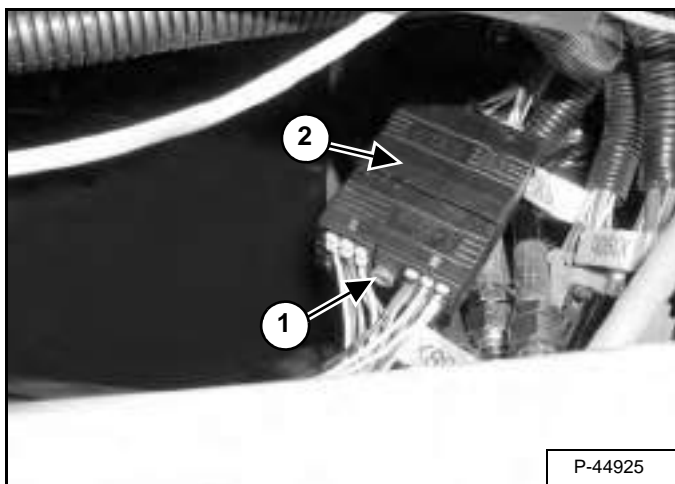

Loosen the screw (Item 1) and unplug the electrical connector (Item 2) [Figure 50-10-6].

## WARNING

Hydraulic fluid escaping under pressure can have sufficient force to enter a person's body by penetrating the skin. This can cause serious injury and possible death if proper medical treatment by a physician familiar with this injury is not received immediately.

W-2145-0290

## IMPORTANT

When repairing hydrostatic and hydraulic systems, clean the work area before disassembly and keep all parts clean. Always use caps and plugs on hoses, tubelines and ports to keep dirt out. Dirt can quickly damage the system.

I-2003-0888

Figure 50-10-7

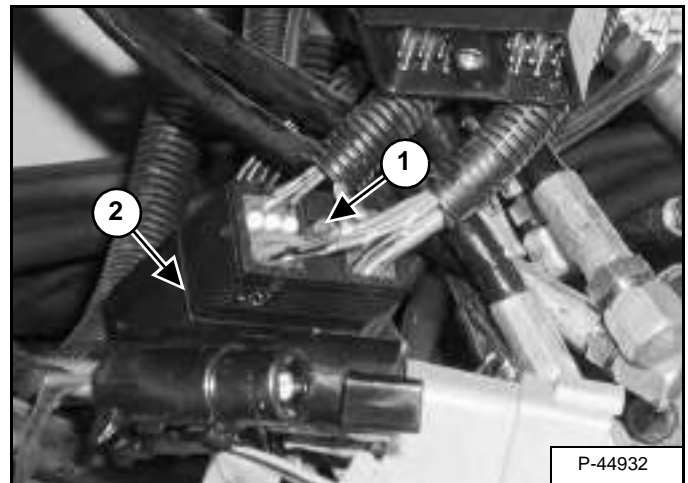

Loosen the screw (Item 1) and unplug the electrical connector (Item 2) [Figure 50-10-7].

Figure 50-10-8

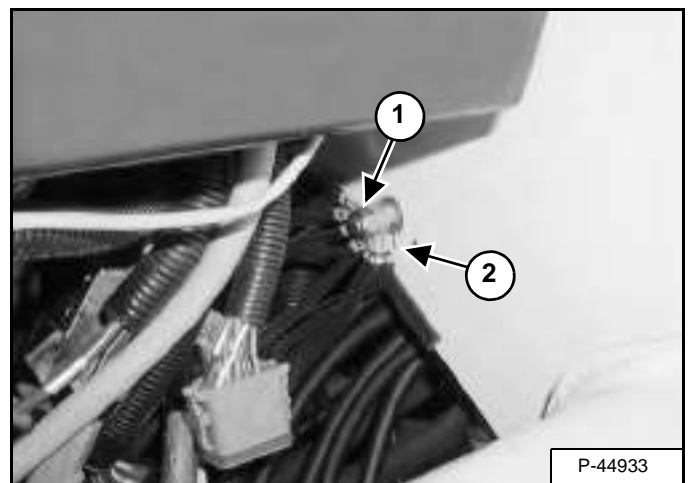

Remove the nut (Item 1) and ground wires (Item 2) [Figure 50-10-8].



## OPERATOR CAB (CONT'D)

### Removal and Installation (Cont'd)

Figure 50-10-9

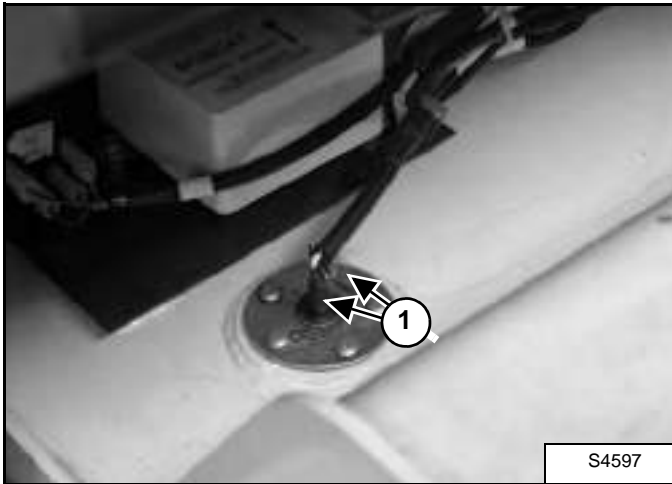

Remove the two wires (Item 1) [Figure 50-10-9] from the fuel sending unit.

Remove the travel / signal levers (See "Removal And Installation" on page 50-130-1).

Remove the instrument panel (See "Removal And Installation" on page 50-130-1).

Remove the switch panel (See "Removal And Installation" on page 50-130-1).

Remove the dash cover / steering column cover (See "Removal And Installation" on page 50-130-1).

Drain the radiator (See "Removal And Installation" on page 70-50-1).

Figure 50-10-10

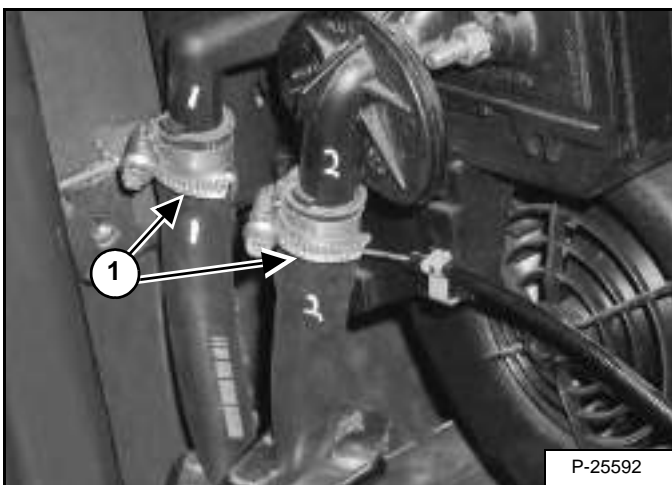

Remove the heater hoses (Item 1) [Figure 50-10-10] from the heater assembly.

**NOTE:** Mark the hoses for correct installation.

Figure 50-10-11

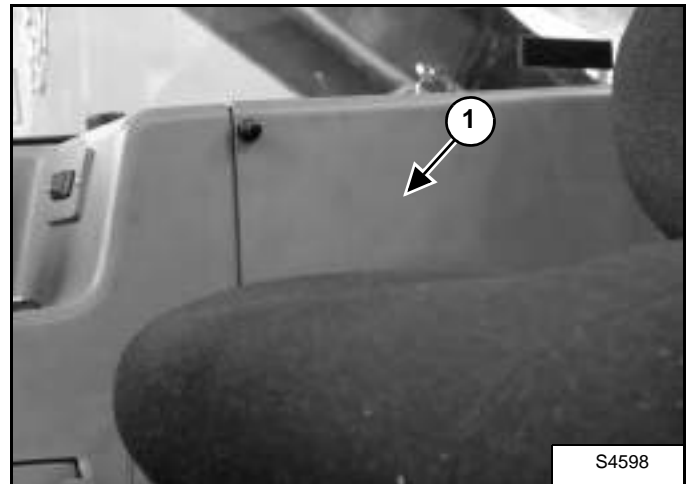

Remove the fuse box cover (Item 1) [Figure 50-10-11].

Open the engine cover.

## OPERATOR CAB (CONT'D)

### Removal and Installation (Cont'd)

Figure 50-10-12

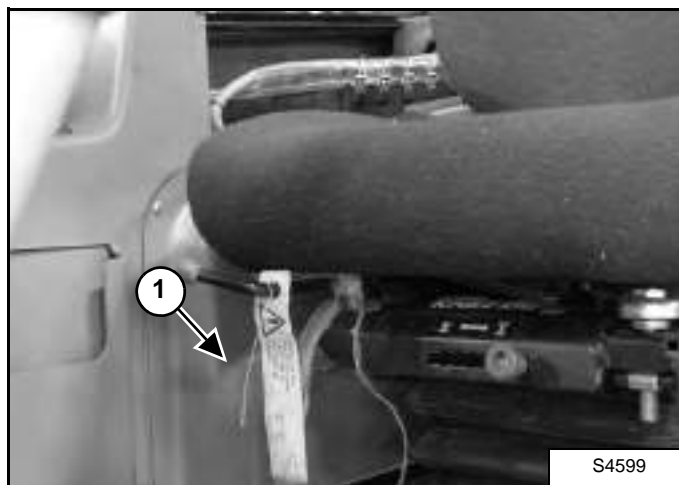

Remove the side cover (Item 1) [Figure 50-10-12].

Figure 50-10-13

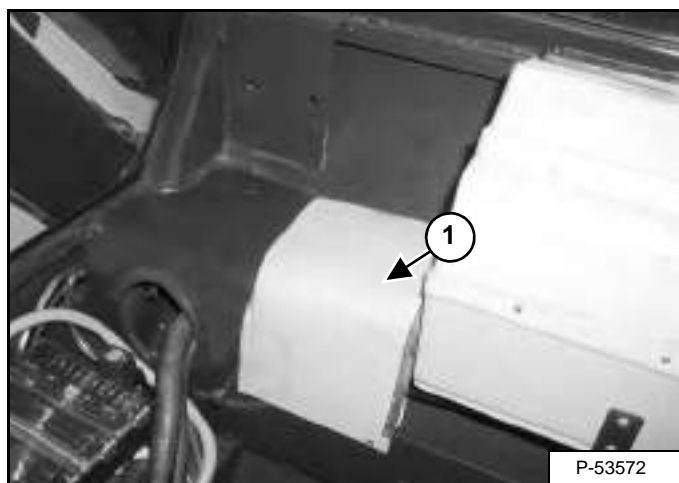

Remove the cover (Item 1) [Figure 50-10-13].

If machine is equipped with air conditioning, remove the refrigerant from the A/C system (See "Reclamation Procedure" on page 80-100-1).

Figure 50-10-14

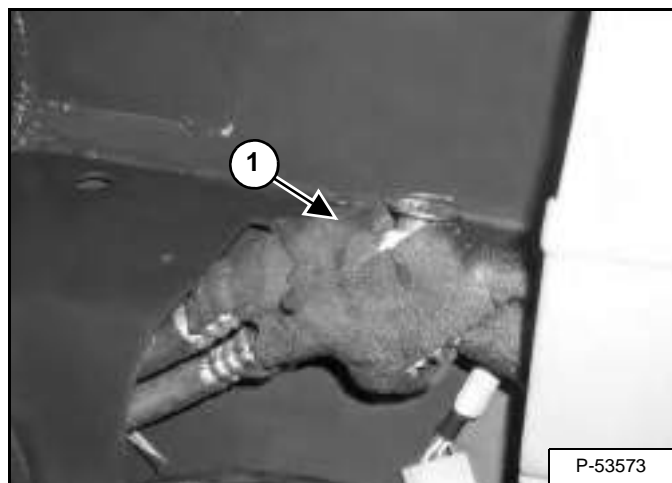

Temporarily remove the protective covering (Item 1) [Figure 50-10-14] from the A/C hoses and expansion valve.

Figure 50-10-15

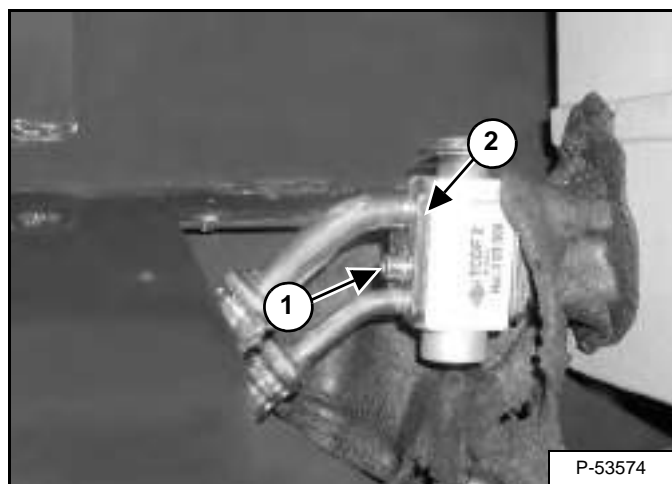

Remove the bolt (Item 1) and plate (Item 2) [Figure 50-10-15]. Remove the A/C hoses.

**NOTE: Plug the A/C hoses to prevent contamination.**

## OPERATOR CAB (CONT'D)

### Removal and Installation (Cont'd)

Figure 50-10-16

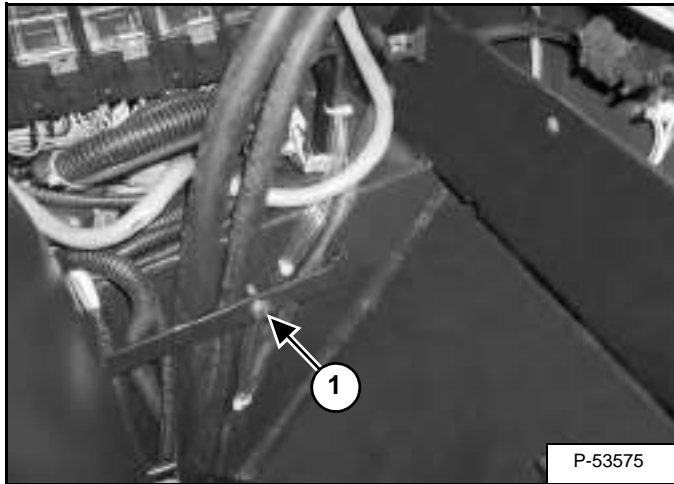

Loosen the mounting bracket bolt (Item 1) [Figure 50-10-16].

Figure 50-10-17

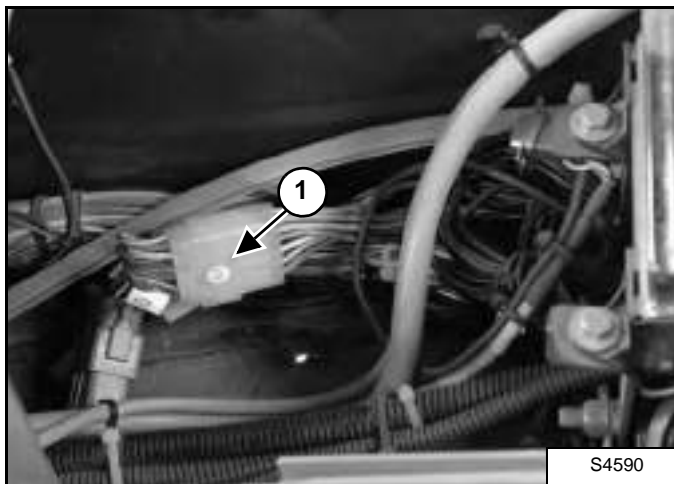

Unplug the connector (Item 1) [Figure 50-10-17] located under the fuse box.

Figure 50-10-18



Remove the two A/C hoses, heater hoses and harness from the rear corner of the cab [Figure 50-10-18].

Figure 50-10-19

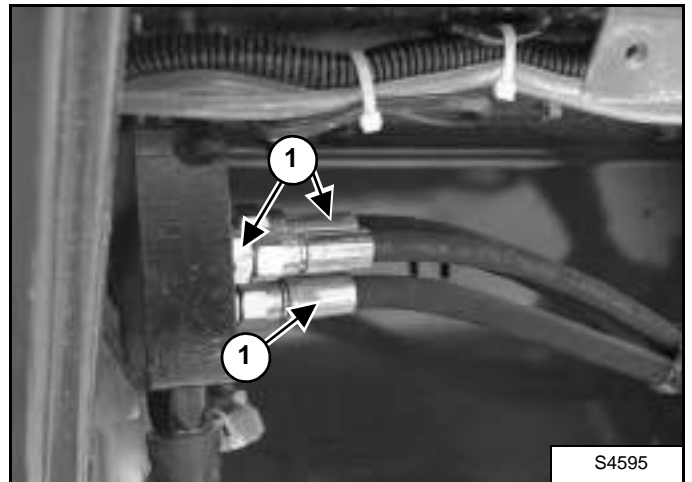

Remove the three hoses (Item 1) [Figure 50-10-19].

Remove any necessary nylon ties.

## OPERATOR CAB (CONT'D)

### Removal and Installation (Cont'd)

Figure 50-10-20

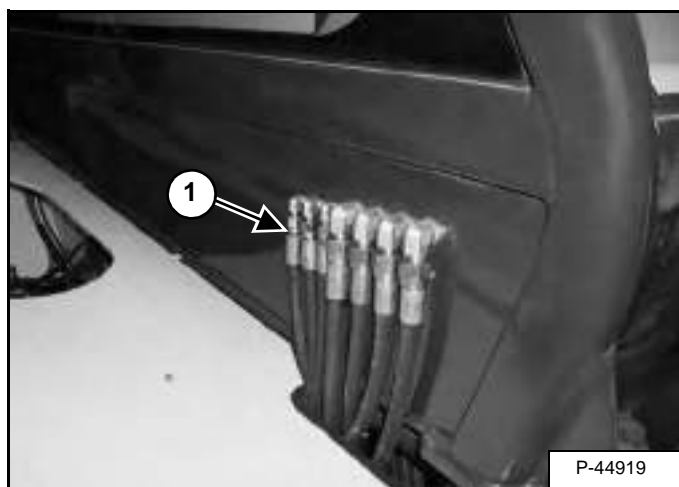

Remove the seven hoses on the right side of the cab [Figure 50-10-20].

Open the engine cover.

Figure 50-10-21

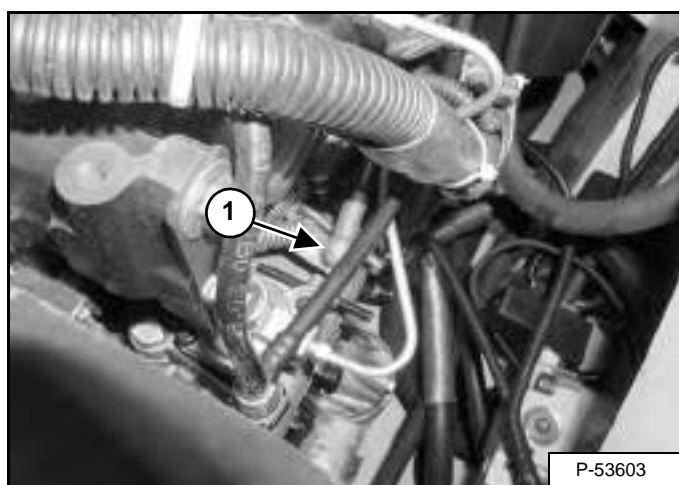

Remove the engine speed control cable (Item 1) [Figure 50-10-21].

Figure 50-10-22

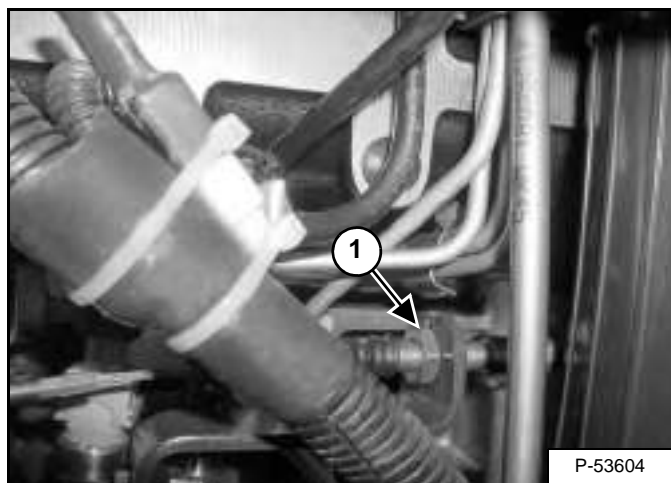

Remove the engine speed control cable (Item 1) [Figure 50-10-22] from the bracket.

Remove any necessary nylon ties, carefully remove the speed control cable from the engine compartment and into the cab.

**NOTE:** Adjust the engine speed control cable during installation (See “Removal And Installation” on page 70-20-1).

Close the engine cover.

Figure 50-10-23



Install a hoist to lift and support the cab [Figure 50-10-23].

## OPERATOR CAB (CONT'D)

### Removal and Installation (Cont'd)

Figure 50-10-24

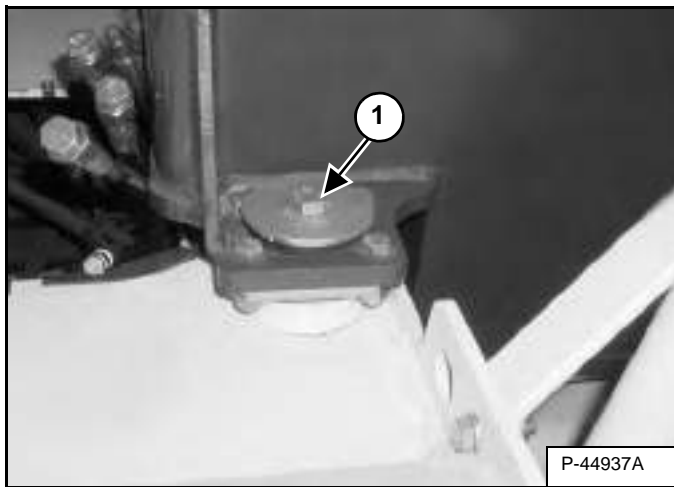

Remove the cab mount bolt (Item 1) [Figure 50-10-24] from the front of the cab.

Figure 50-10-25

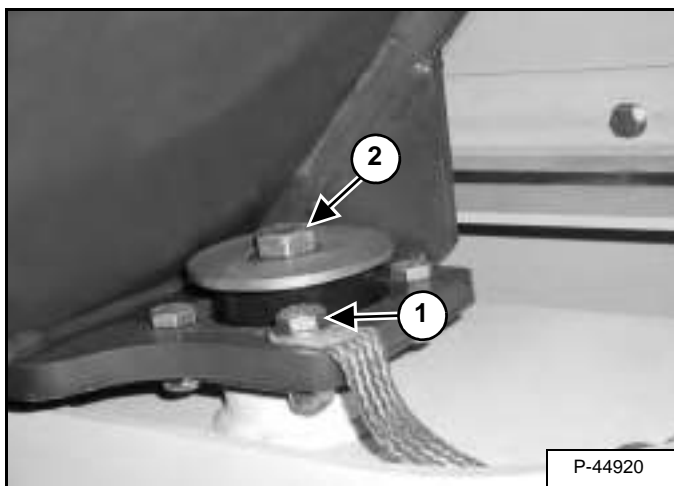

Remove the grounding strap (Item 1) and rear mounting bolt (Item 2) [Figure 50-10-25].

Figure 50-10-26

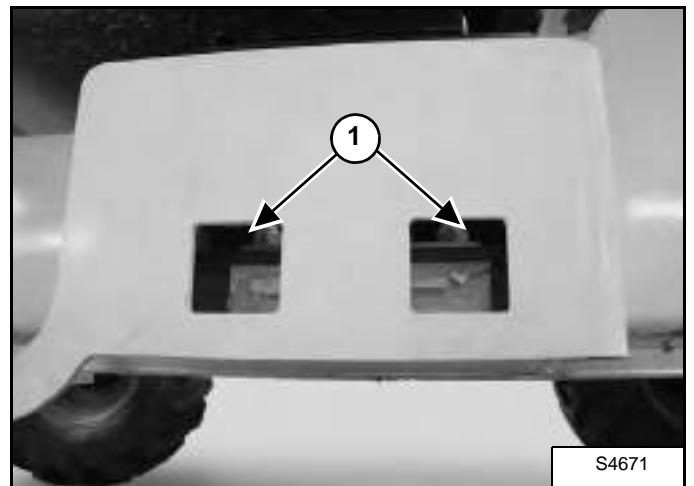

Remove the two bolts (Item 1) and rubber cushions (Item 2) [Figure 50-10-26].

Lift and remove the cab.



**Bobcat®**

## OPERATOR SEAT

### Removal And Installation

Figure 50-20-1



Figure 50-20-2

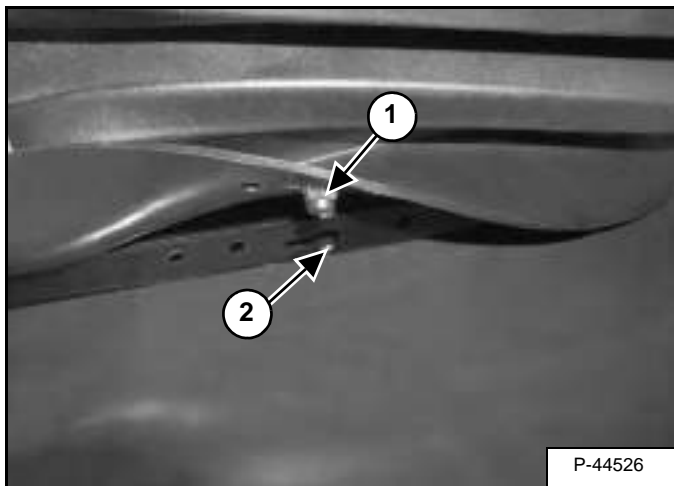

Raise the seat mount cover (Item 1) [Figure 50-20-1] by sliding the bottom edge of the seat mount cover to the right to remove the cover retainers (Item 1) from the seat frame (Item 2) [Figure 50-20-2].

**NOTE:** There are several retainers molded into the bottom edge of the cover.

Figure 50-20-3

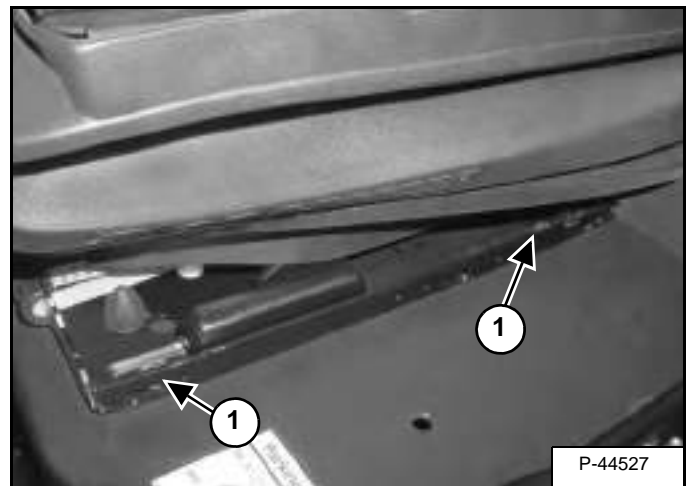

Remove the two seat mount bolts (Item 1) [Figure 50-20-3] from both sides.

Remove the seat.



**Bobcat®**



## BOOM ASSEMBLY

### Removal And Installation

Remove the bucket positioning cylinder.  
(See "Removal And Installation" on page 20-30-1)

Figure 50-30-1

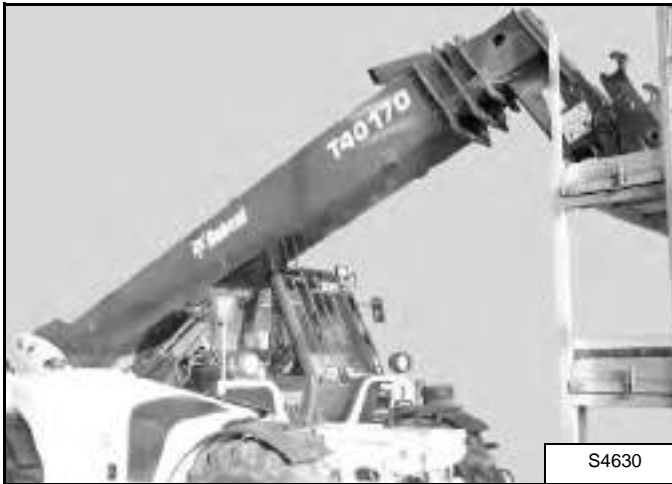

Lower the boom onto adequate stands or blocks as shown [Figure 50-30-1].

Figure 50-30-2



Remove the rear cover (Item 1) [Figure 50-30-2] from the machine.

Figure 50-30-3

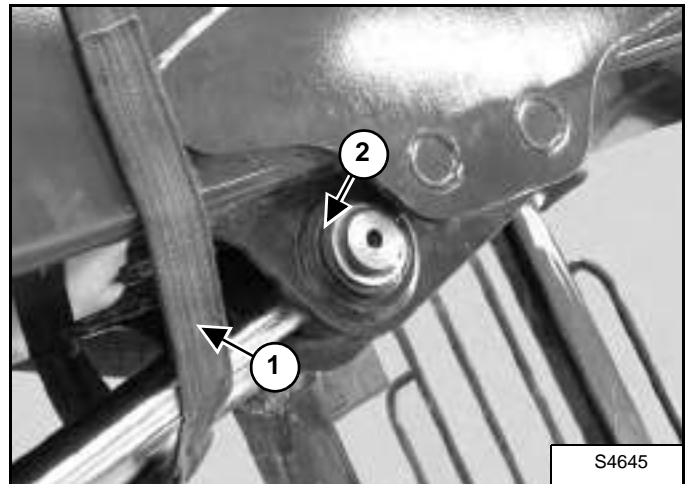

Use a strap and hoist (Item 1) [Figure 50-30-3] to support the lift cylinder and bucket positioning cylinder.

Remove the pivot pin snap ring (Item 2) [Figure 50-30-3] from the rod end.

Figure 50-30-4

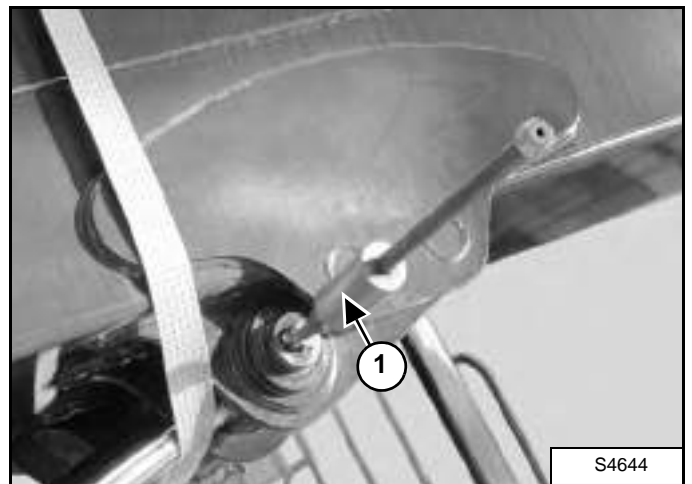

Remove the upper pivot pin using a pin removal tool (Item 1) [Figure 50-30-4].

**NOTE: If a nut must be welded onto the pin for removal the following three steps must be performed:**

1. Rotate the battery disconnect switch to the right to disconnect the power supply from the battery.
2. The side window and frame opening must be protected from sparks.
3. The cylinder rod must be wrapped with a damp welding blanket to prevent damage.

## LIFT CYLINDER (CONT'D)

### Removal And Installation (Cont'd)

Figure 50-30-5



After the upper pivot pin has been removed, the rod end of the cylinders should be lowered onto a wood block, positioned as shown [Figure 50-30-5].

Figure 50-30-6

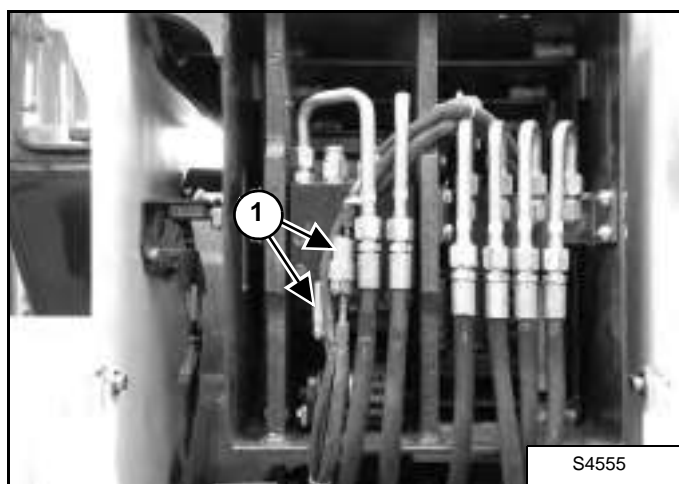

Disconnect the harness connectors (Item 1) [Figure 50-30-6]. (If Equipped)

# IMPORTANT

When repairing hydrostatic and hydraulic systems, clean the work area before disassembly and keep all parts clean. Always use caps and plugs on hoses, tubelines and ports to keep dirt out. Dirt can quickly damage the system.

I-2003-0888

Figure 50-30-7

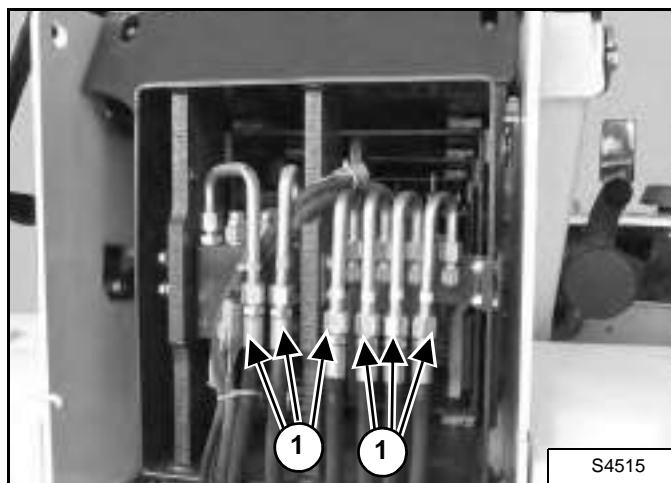

Disconnect the six hydraulic hoses (Item 1) [Figure 50-30-7] from the tubelines.

Figure 50-30-8



Lower the boom onto adequate stands or blocks by means of the hoist [Figure 50-30-8].

**NOTE:** Mark the hoses for correct installation.

## BOOM ASSEMBLY (CONT'D)

### Removal And Installation (Cont'd)

Figure 50-30-9

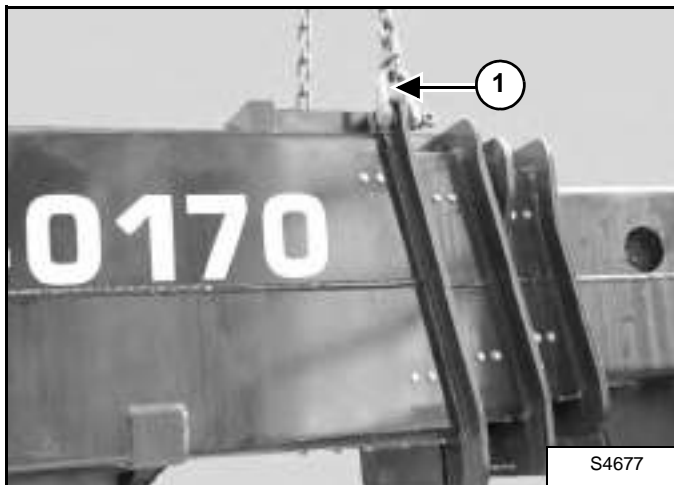

Install a lifting chain (Item 1) [Figure 50-30-9] on the front of the boom.

Figure 50-30-10

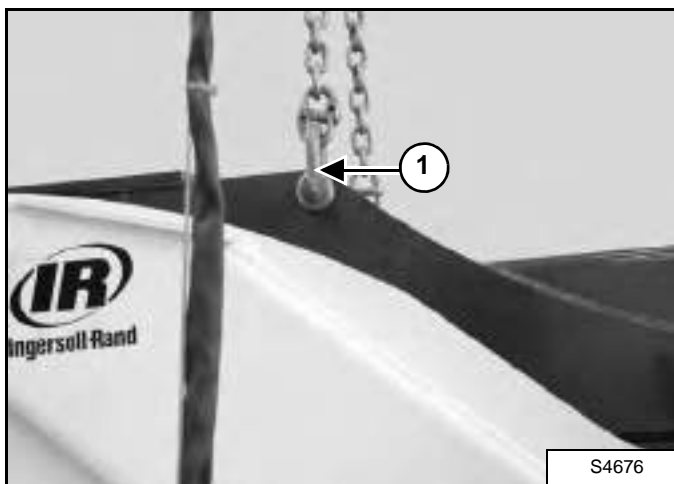

Install a lifting chain (Item 1) [Figure 50-30-10] on the rear of the boom.

Raise the hoist until the weight of the boom is supported by the hoist.

Figure 50-30-11



Remove the bolt (Item 1) and washer (Item 2) [Figure 50-30-11] from the boom pin.

Figure 50-30-12



Remove the boom pin [Figure 50-30-12].

Lift and remove the boom assembly.



**Bobcat®**

## END BOOM

### Removal

Remove the boom tray (See "Removal And Installation" on page 50-50-1).

Remove the extension cylinder (See "Cylinder Group Removal And Installation" on page 50-50-1).

Figure 50-40-1

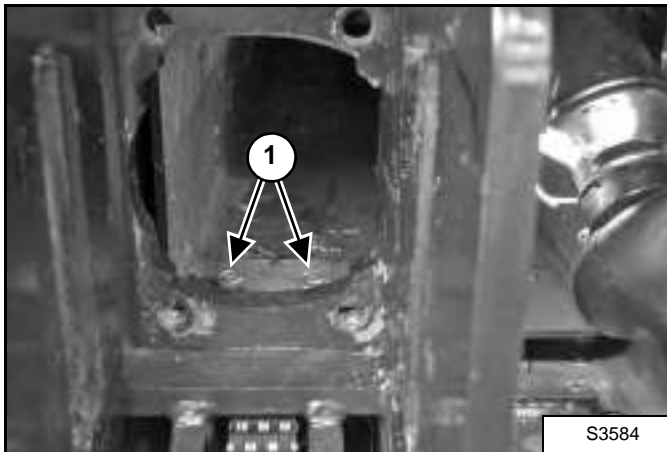

Disconnect the retraction chain (Item 1) [Figure 50-40-1] at the rear of the end boom.

Figure 50-40-2

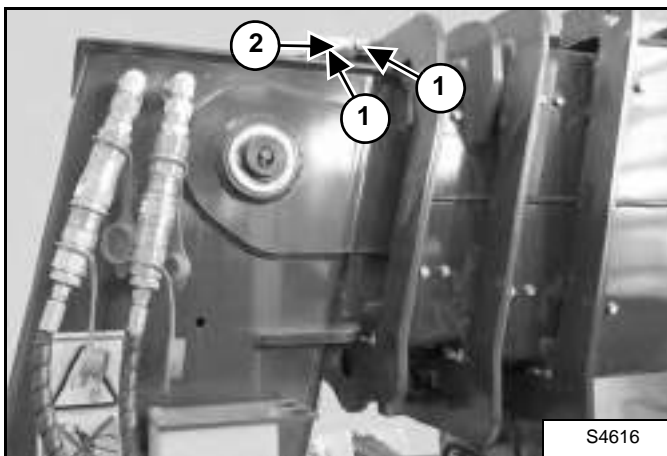

Disconnect the two bolts (Item 1) and the plate (Item 2) [Figure 50-40-2] at the front of the intermediate boom.

Figure 50-40-3

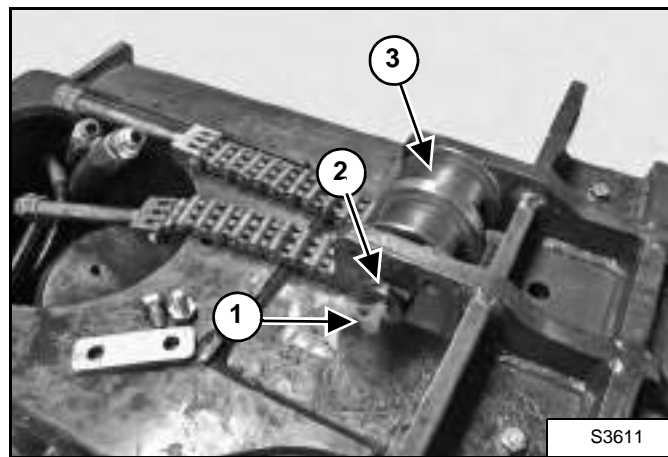

Disconnect the grease nipple (Item 1), the spindle (Item 2), and the pulley (Item 3) [Figure 50-40-3] at the front of the intermediate boom.

Figure 50-40-4

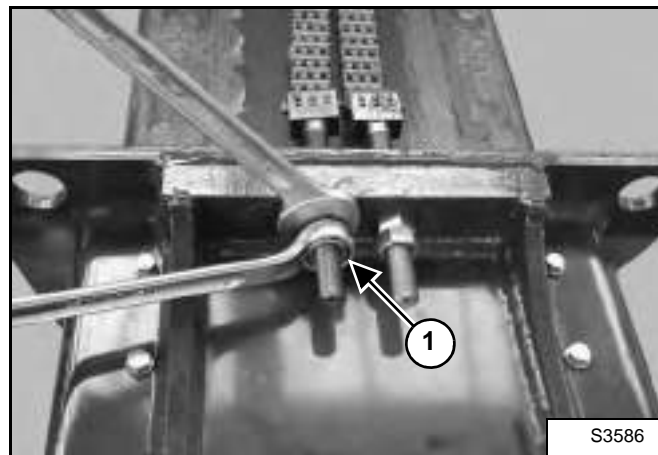

Disconnect the extension chain (Item 1) [Figure 50-40-4] at the front of the fixed boom.

## END BOOM (CONT'D)

### Removal (Cont'd)

Figure 50-40-5

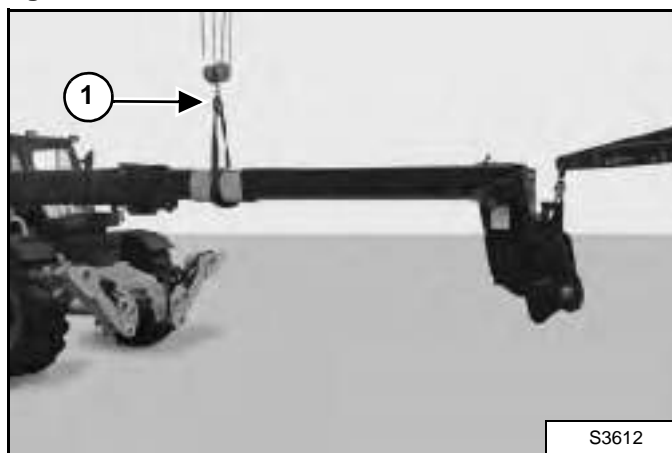

Begin sliding the end boom from the intermediate boom. Before the end boom is completely removed, position a hoist and a lifting strap on the front of the end boom (Item 1) [Figure 50-40-5].

Remove the front wear pads of the intermediate boom (See "Removal" on page 50-50-1).

Figure 50-40-6

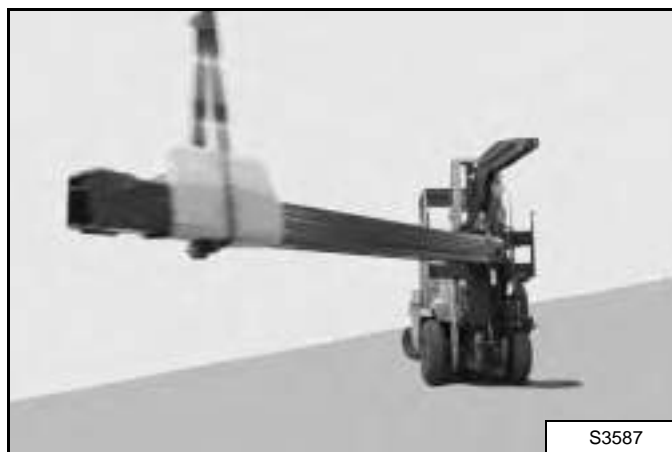

Carefully remove the end boom completely [Figure 50-40-6].

Figure 50-40-7

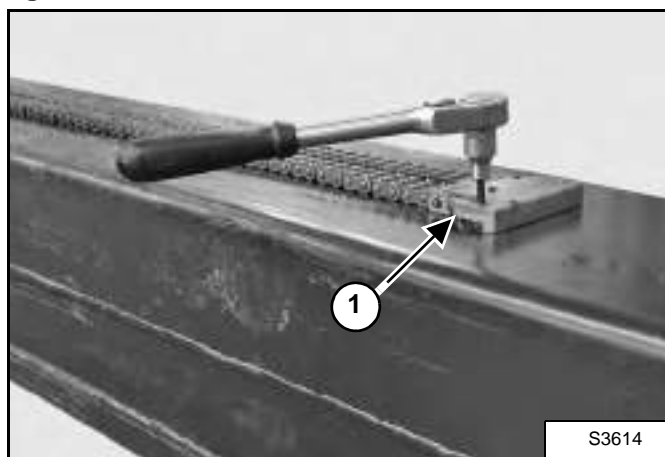

Disconnect the extension chain (Item 1) [Figure 50-40-7] at the rear of the end boom.

Remove the rear wear pads of the end boom (See "Removal" on page 50-60-1).

## END BOOM (CONT'D)

### Installation

Figure 50-40-8

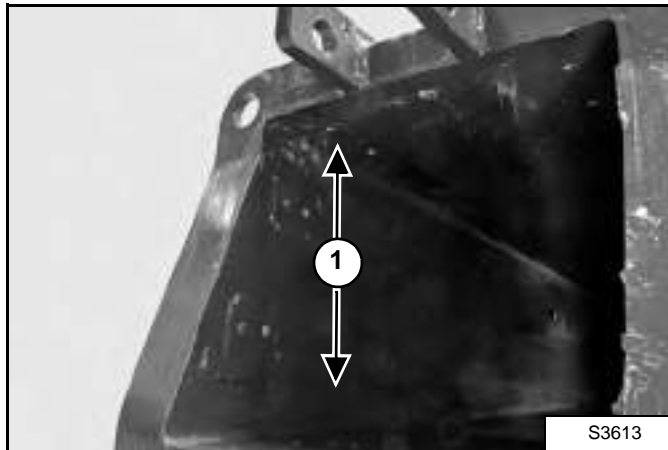

Apply grease to the inside top and bottom corners of the intermediate boom (Item 1) [Figure 50-40-8].

Install the rear wear pads on the end boom (See "Installation" on page 50-60-1).

Figure 50-40-9

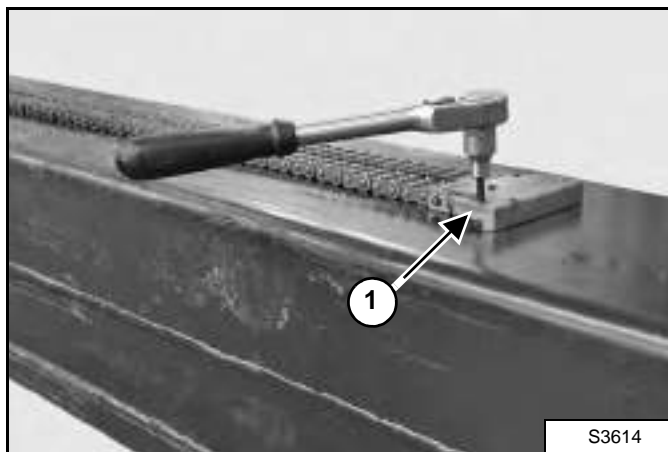

Connect the extension chain (Item 1) [Figure 50-40-9] at the rear of the end boom.

Figure 50-40-10

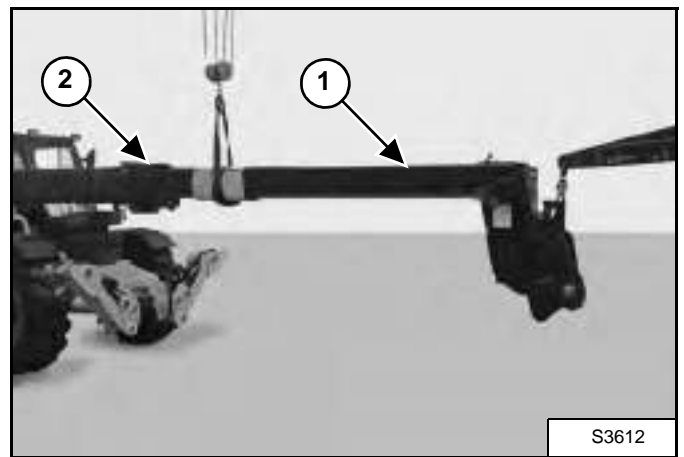

Install the end boom (Item 1) into the intermediate boom (Item 2) [Figure 50-40-10] approximately 10 Inch.

Install the front wear pads on the intermediate boom (See "Installation" on page 50-50-2).

Remove the hoist and lifting strap and slide the end boom fully into the intermediate boom.

Figure 50-40-11

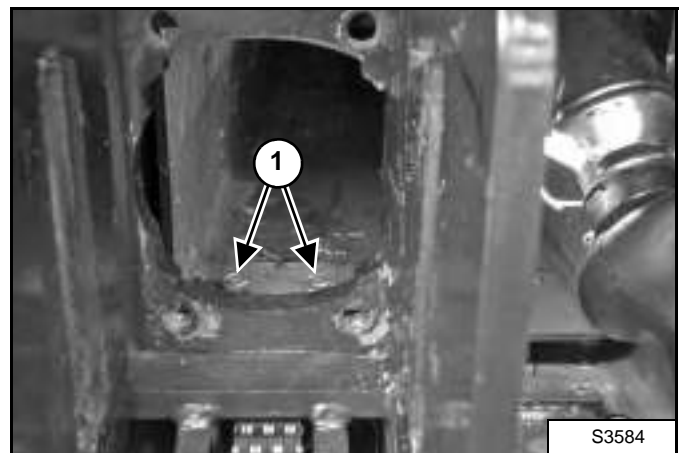

Connect the retraction chain at the rear of the end boom. (Item 1) [Figure 50-40-11].

## END BOOM (CONT'D)

### Installation (Cont'd)

Figure 50-40-12

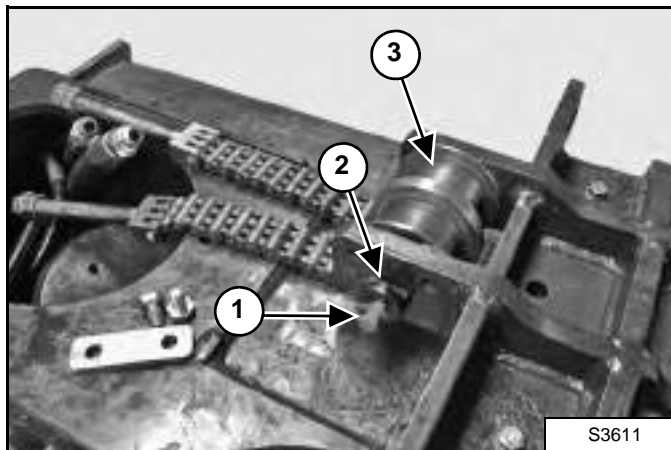

Connect the grease nipple (Item 1), the spindle (Item 2) and the pulley (Item 3) [Figure 50-40-12] at the front of the intermediate boom.

Figure 50-40-13

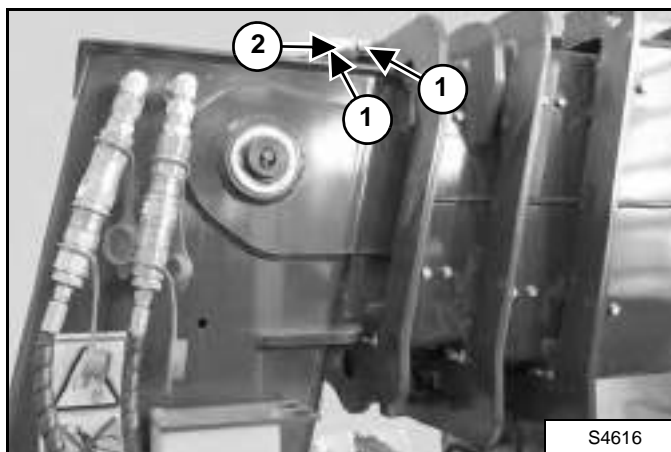

Connect the two screws (Item 1) and the plate (Item 2) [Figure 50-40-13] at the front of the intermediate boom.

Figure 50-40-14

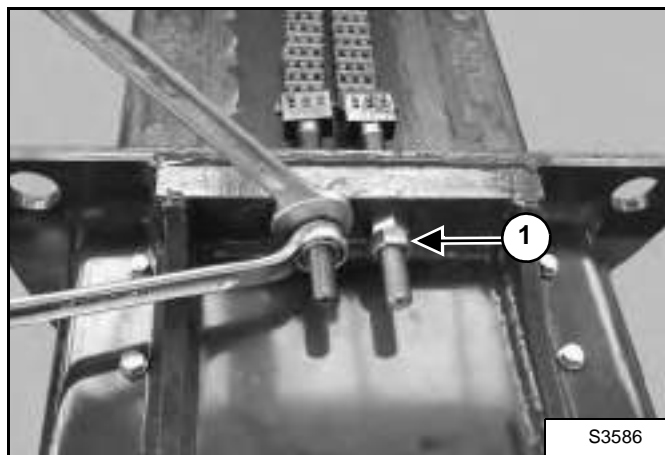

Connect the extension chain at the front of the fixed boom (Item 1) [Figure 50-40-14].

Install the extension cylinder (See "Cylinder Group Removal And Installation" on page 20-40-1.)

Install the boom tray (See "Removal And Installation" on page 50-160-1.)

Adjust the extension and retraction chains (See "Checking The Tension Of The Telescoping Chains Of The T40140 / T40170" on page 50-170-1.)



## WEAR PADS (FRONT)

### Removal

Figure 50-50-1

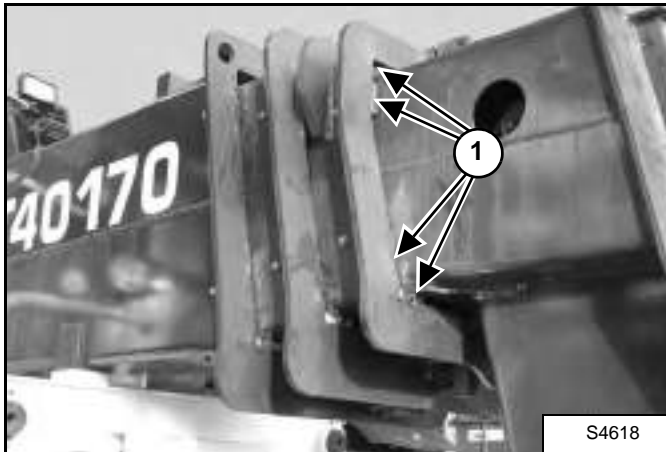

Extend the inner boom and mark the location of the inner supports and wear pads (Item 1) [Figure 50-50-1].

Figure 50-50-2

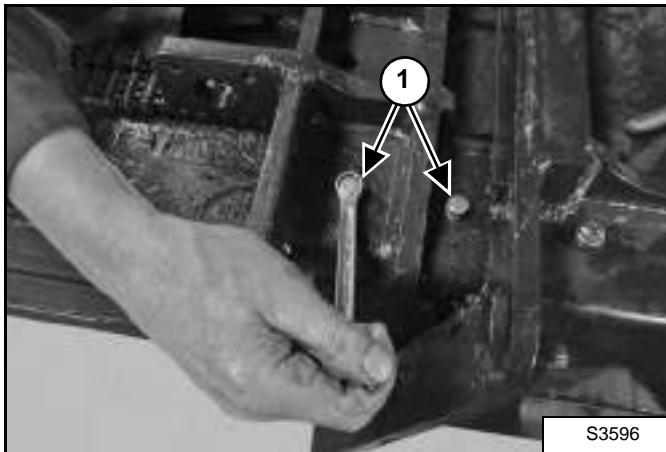

Remove the bolts of the upper, lower and side wear pads (Item 1) [Figure 50-50-2].

Figure 50-50-3

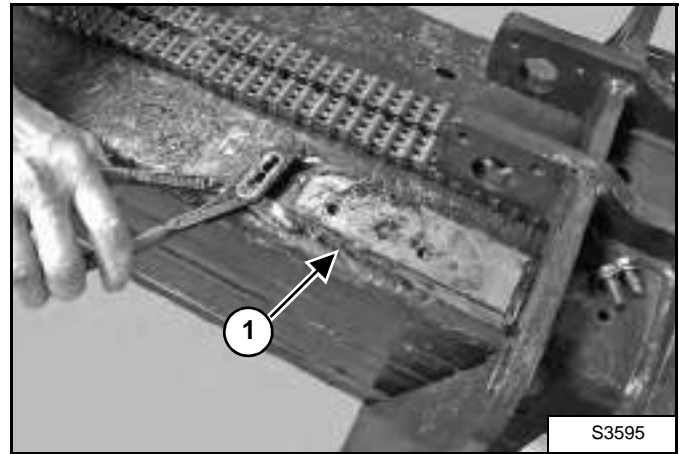

Remove the upper and side wear pads (Item 1) [Figure 50-50-3].

With both upper wear pads removed, use a hoist and lifting strap at the end of the boom, apply upwards pressure, lifting the inner boom off the bottom wear pads. Remove the lower wear pads.

## WEAR PADS (FRONT) (CONT'D)

### Installation

Figure 50-50-4



Make sure that the surface of the boom is cleaned before installing the pads.

Figure 50-50-5

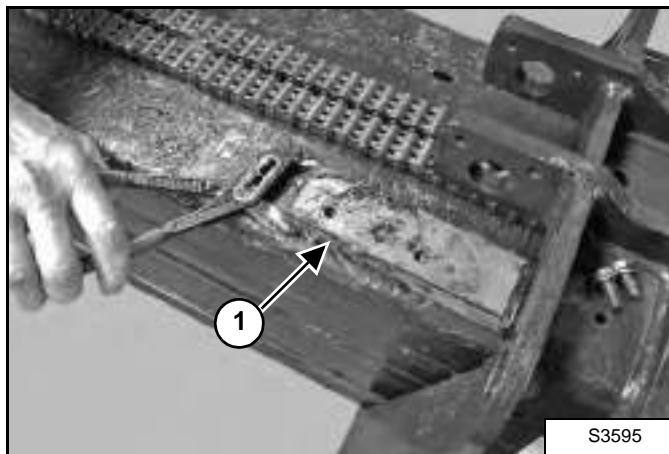

Install the two upper wear pads (Item 1) [Figure 50-50-5].

Figure 50-50-6

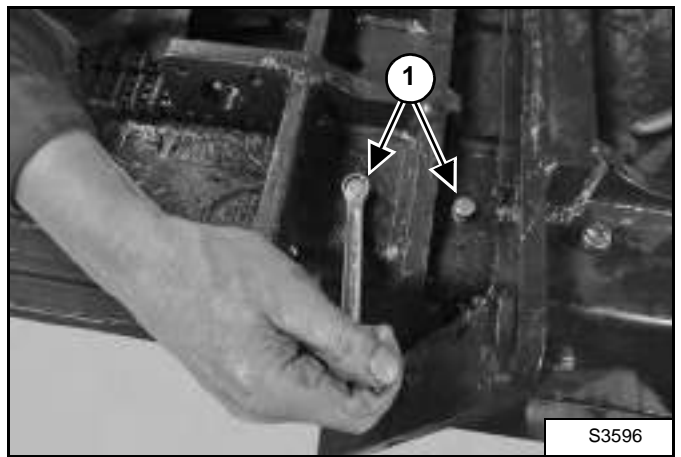

Tighten the bolts (Item 1) [Figure 50-50-6] of the upper wear pads.

**Installation:** Tighten the bolts to 43 ft.-lb. (58 N•m).

Figure 50-50-7

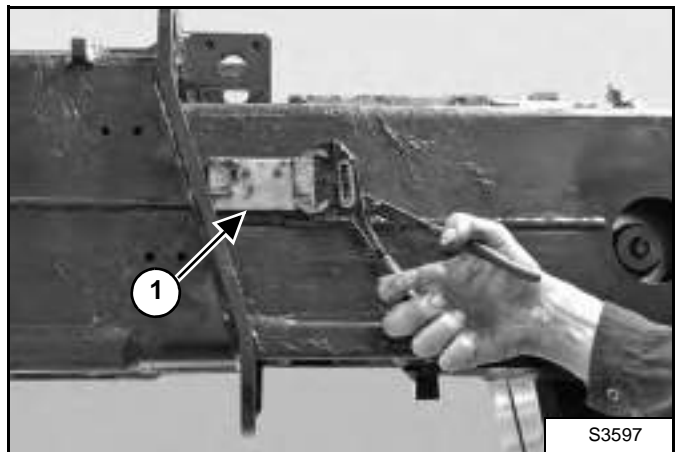

Install the four wear pads at the left and right side of the boom (Item 1) [Figure 50-50-7].

## WEAR PADS (FRONT) (CONT'D)

### Installation (Cont'd)

Figure 50-50-8

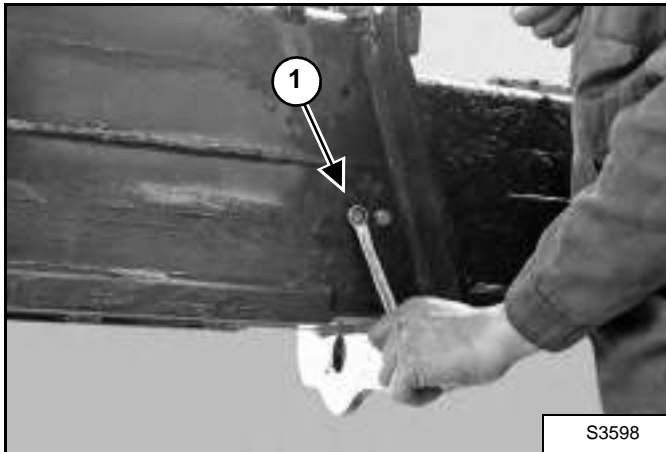

Tighten the bolts of the wear pads (Item 1) [Figure 50-50-8].

**Installation:** Tighten the bolts to 58 ft.-lb. (43 N•m).

With both upper wear pads installed, use a hoist and lifting strap at the end of the boom, apply upwards pressure, lifting the inner boom off the bottom wear pads.

Figure 50-50-9

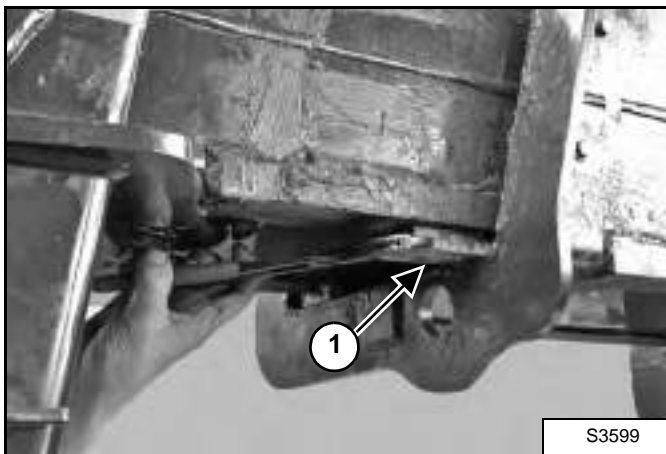

Install the two lower wear pads (Item 1) [Figure 50-50-9].

Figure 50-50-10

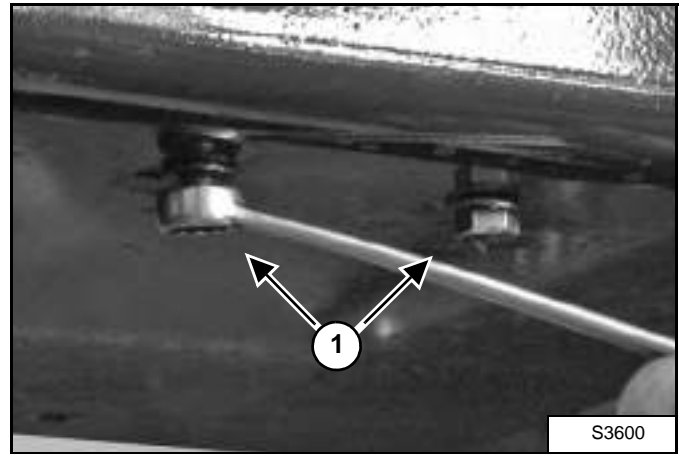

Tighten the bolts (Item 1) [Figure 50-50-10] of the lower wear pads.

**Installation:** Tighten the bolts to 43 ft.-lb. (58 N•m).

Figure 50-50-11



Apply grease to the pads using a grease pump [Figure 50-50-11].

**Installation:** Tighten the bolts to 43 ft.-lb. (58 N•m).



**Bobcat®**

## WEAR PADS (REAR)

### Removal

Figure 50-60-1

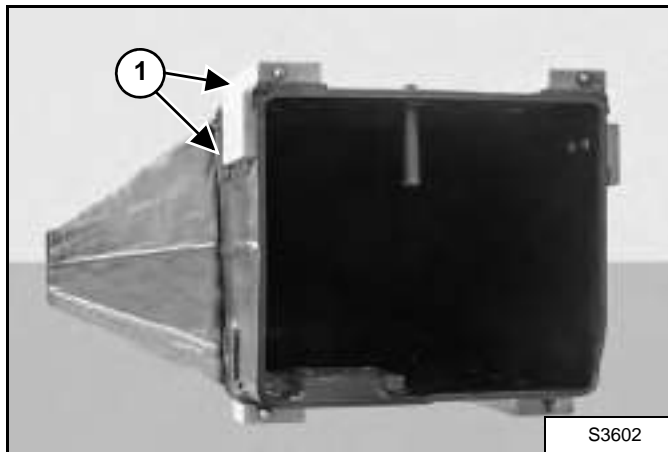

Remove the end / intermediate boom and mark the location of the wear pads (Item 1) [Figure 50-60-1].

Figure 50-60-2

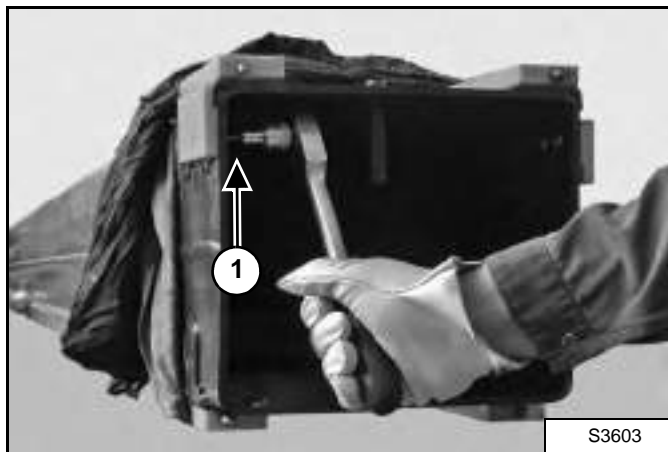

With the end / intermediate boom supported, remove the bolts and the pads (Item 1) [Figure 50-60-2].

### Installation

Figure 50-60-3



Make sure that the surface of the boom is cleaned before installing the pads.

Figure 50-60-4

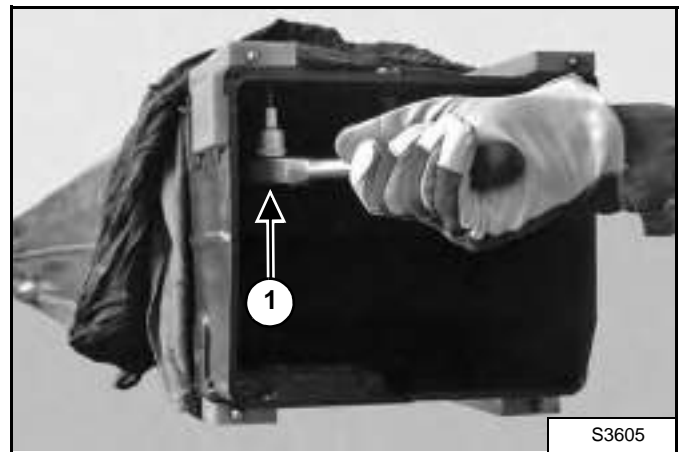

Install the six pads and tighten the bolts (Item 1) [Figure 50-60-4].

**Installation:** Tighten the bolts to 29 ft.-lb. (39 N•m).

---

## WEAR PADS (REAR) (CONT'D)

### Installation (Cont'd)

Figure 50-60-5



Apply grease to the pads.

Figure 50-60-6

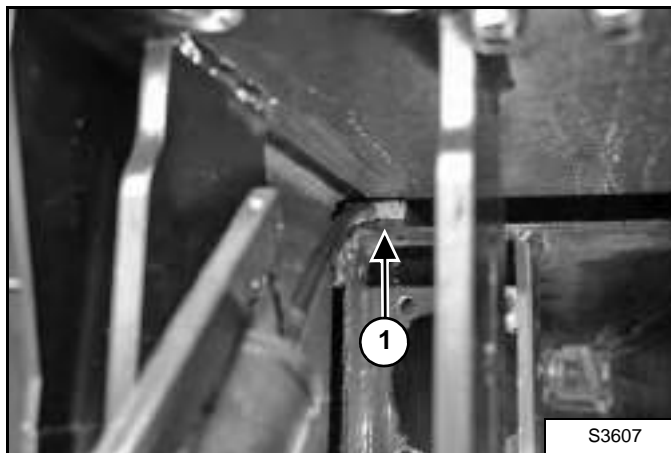

After installing the boom, apply grease to the pads using a grease pump (Item 1) [Figure 50-60-6].

## ENGINE COVER

### Gas Cylinder Removal And Installation

Figure 50-70-1



Lift the engine cover [Figure 50-70-1]. Add a support to prevent the cover from closing when the gas cylinder is removed.

Remove the retainer clips (Item 1) [Figure 50-70-1] at both of the ball joints ends. Remove the ball joints from the ends.

Remove the gas cylinder.

## **WARNING**

Cylinder contains high pressure gas. Do not open. Opening cylinder can release rod and cause injury or death.

W-2113-0288

## Removal And Installation

Remove the gas cylinder.

Figure 50-70-2

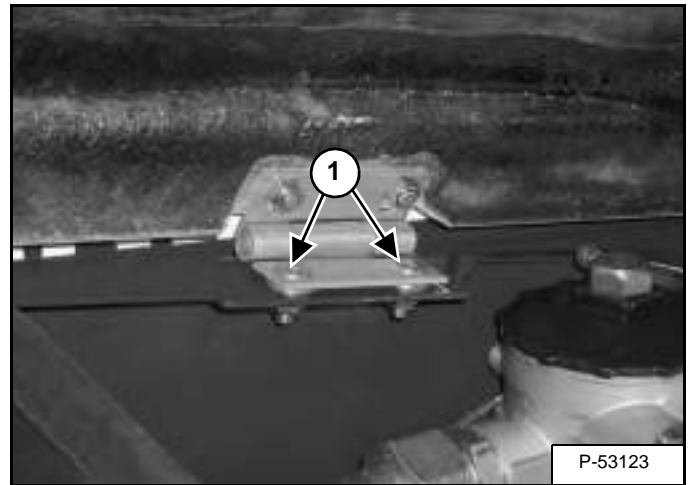
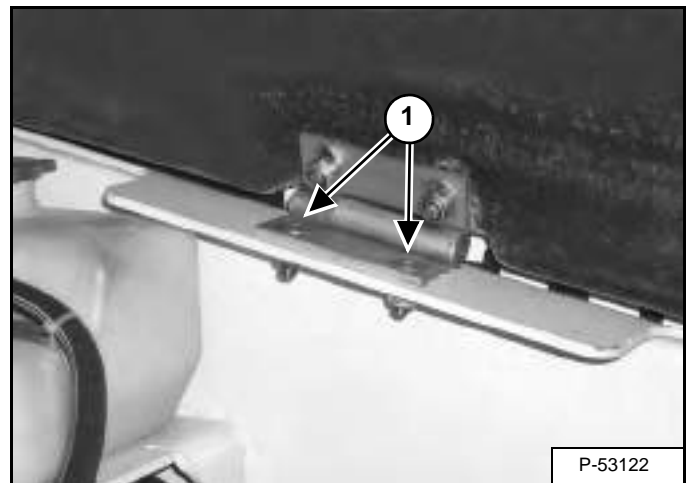

Figure 50-70-3



Remove the four hinge mounting bolts (Item 1) [Figure 50-70-2] & [Figure 50-70-3].

Remove the engine cover.



**Bobcat®**



## AIR INTAKE COWLING

### Removal And Installation

Figure 50-71-1

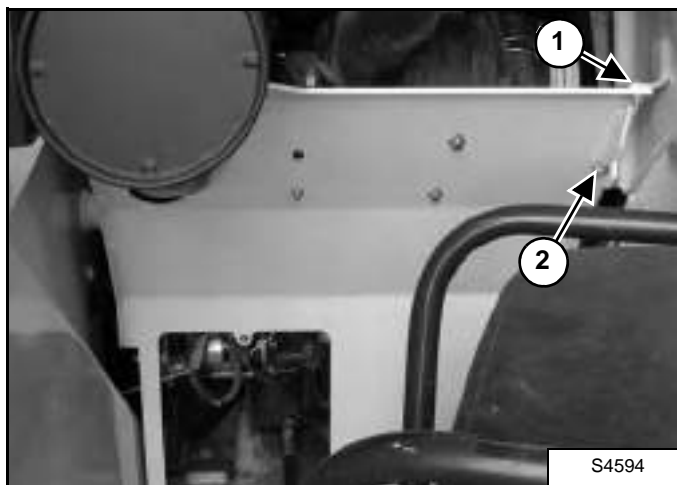

Remove the bolts (Items 1 & 2) [Figure 50-71-1].

Figure 50-71-2

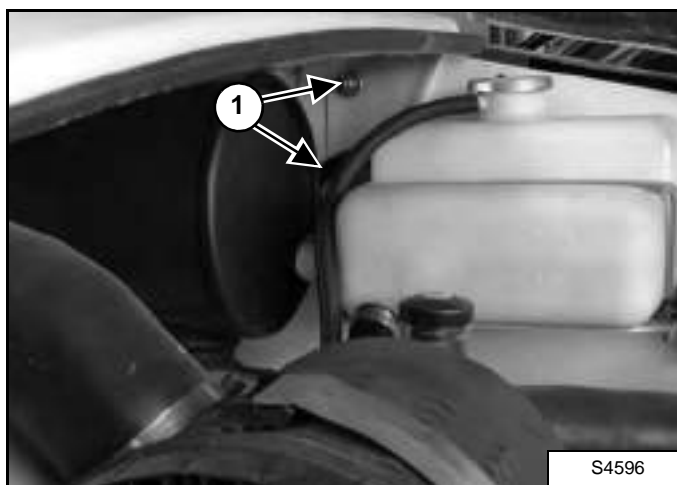

While supporting the air intake cowling remove the two bolts (Item 1) [Figure 50-71-2].

Remove the air intake cowling.



**Bobcat®**

## FUEL TANK

### Removal And Installation

Figure 50-80-1

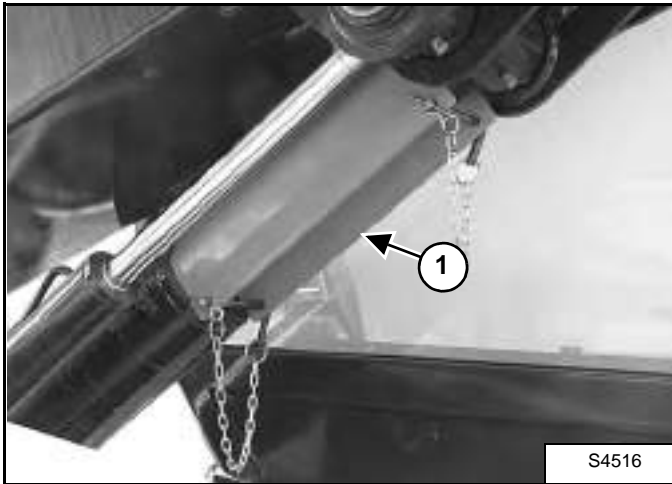

Raise the boom and install the boom stop (Item 1) [Figure 50-80-1].

Remove the battery (See "Removal And Installation" on page 60-20-1).

Figure 50-80-2



Install a hoist to lift and support the cab [Figure 50-80-2].

Figure 50-80-3

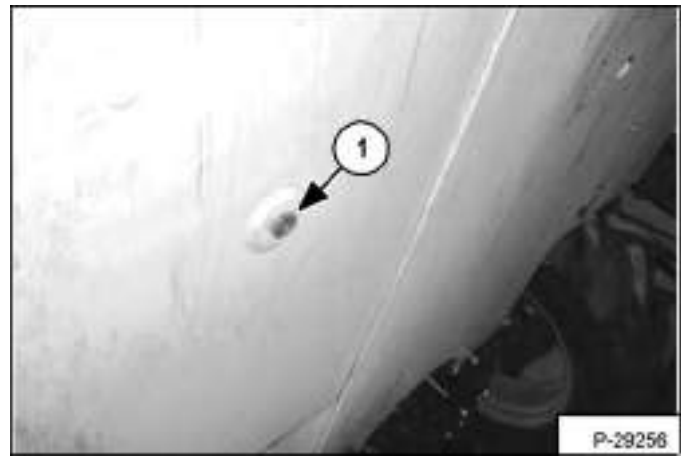

Drain the fuel from the fuel tank by removing the plug (Item 1) [Figure 50-80-3].

Figure 50-80-4

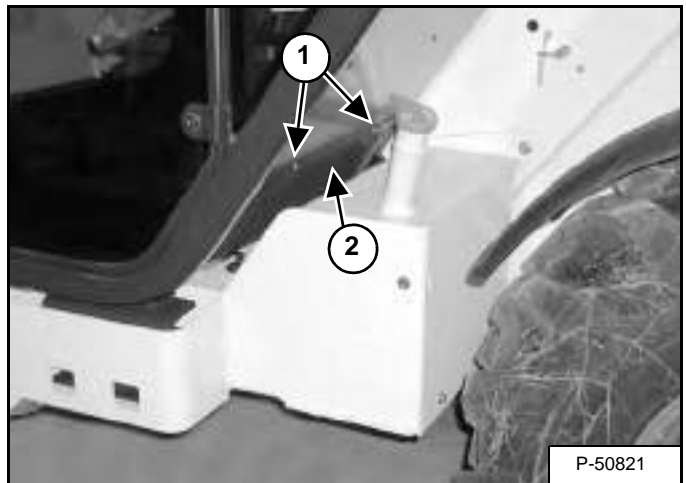

Remove the three screws (Item 1) and remove the access panel (Item 2) [Figure 50-80-4].

## FUEL TANK (CONT'D)

### Removal And Installation (Cont'd)

Figure 50-80-5

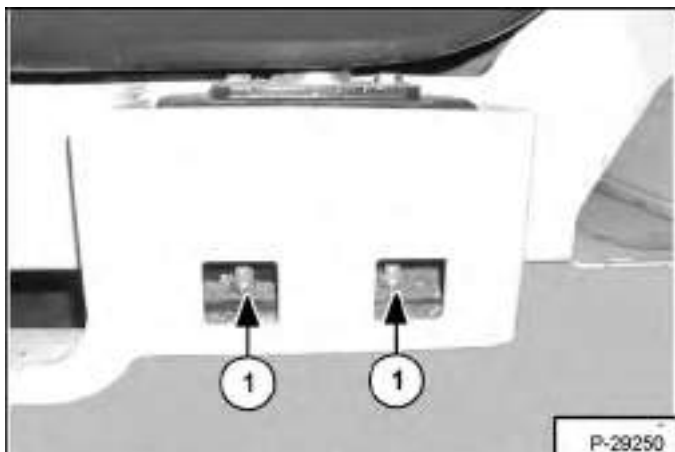

Remove the two bolts (Item 1) [Figure 50-80-5] from the cab spring.

Figure 50-80-6

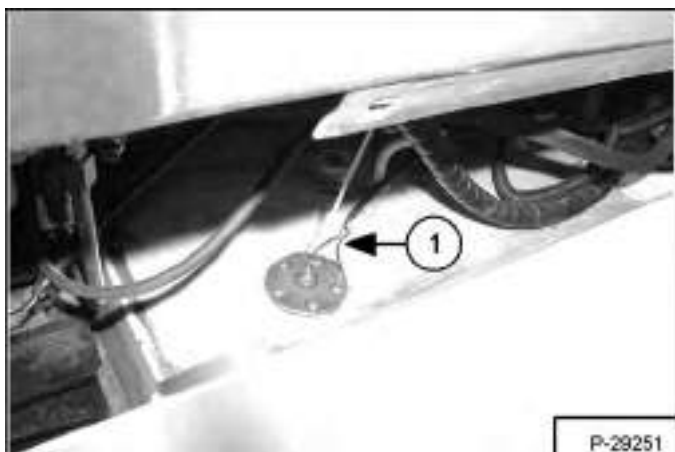

Remove the two wires (Item 1) [Figure 50-80-6] from the fuel sending unit.

**NOTE: Mark the wires for correct installation.**

Figure 50-80-7

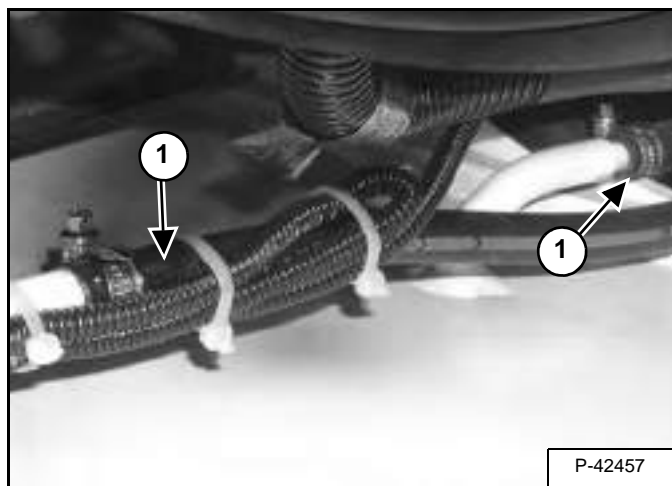

Remove the two hoses (Item 1) [Figure 50-80-7] from the fuel tank.

**NOTE: Mark the hoses for correct installation.**

Figure 50-80-8

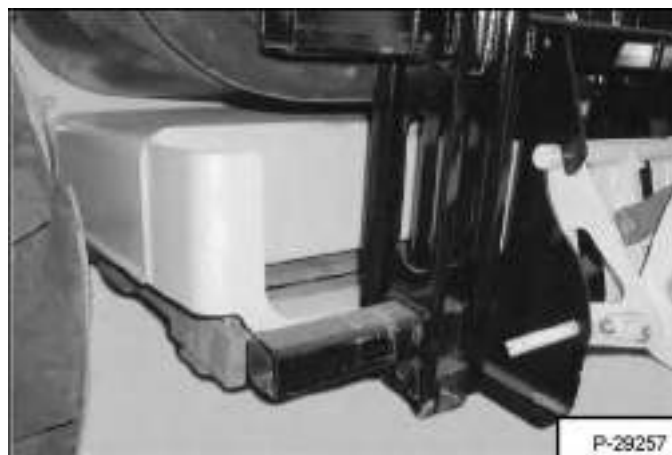

Support the fuel tank using a forklift or jack [Figure 50-80-8].

## FUEL TANK (CONT'D)

### Removal And Installation (Cont'd)

Figure 50-80-9

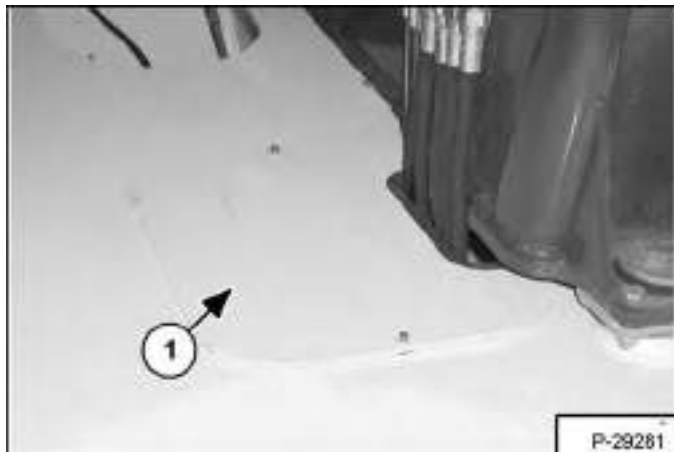

Remove the access panel (Item 1) [Figure 50-80-9].

Figure 50-80-10

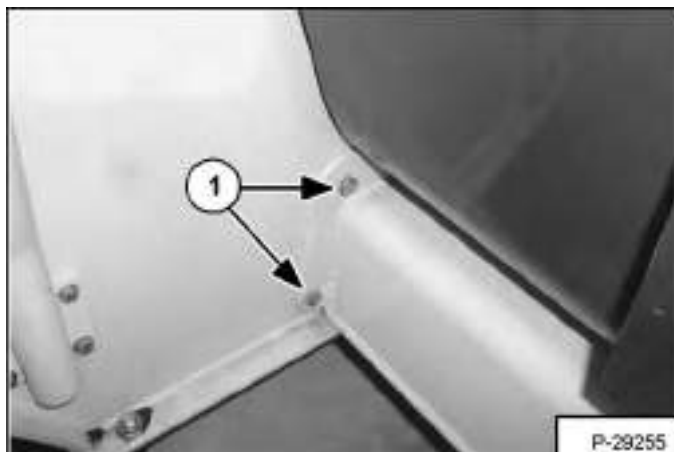

Remove the two mounting bolts (Item 1) [Figure 50-80-10] from the front of the fuel tank.

Figure 50-80-11

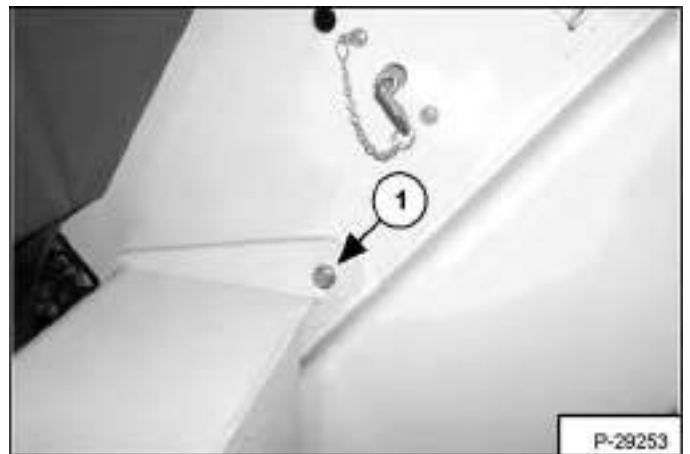
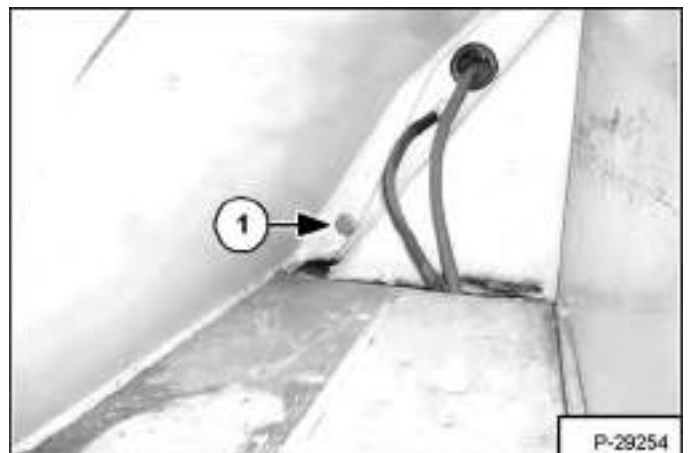

Figure 50-80-12



Remove the mounting bolts (Item 1) [Figure 50-80-11] & [Figure 50-80-12] from the rear of the fuel tank.

---

## FUEL TANK (CONT'D)

### Removal And Installation (Cont'd)

Figure 50-80-13



Carefully lower and remove the fuel tank  
[Figure 50-80-13].

## QUICK TACH

### Removal And Installation

Figure 50-90-1

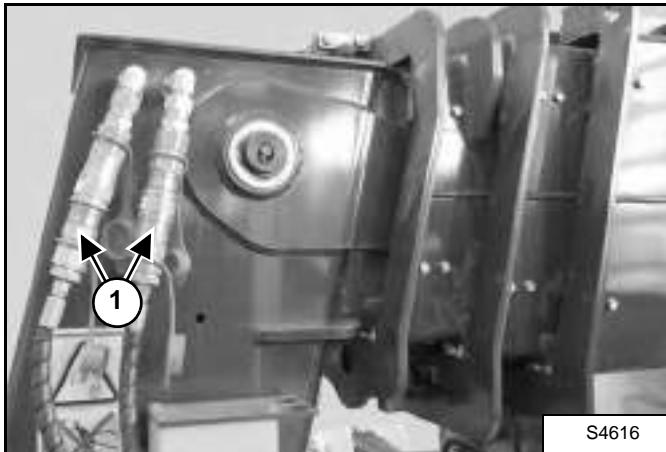

Disconnect the hydraulic couplers (Item 1) [Figure 50-90-1].

Figure 50-90-2

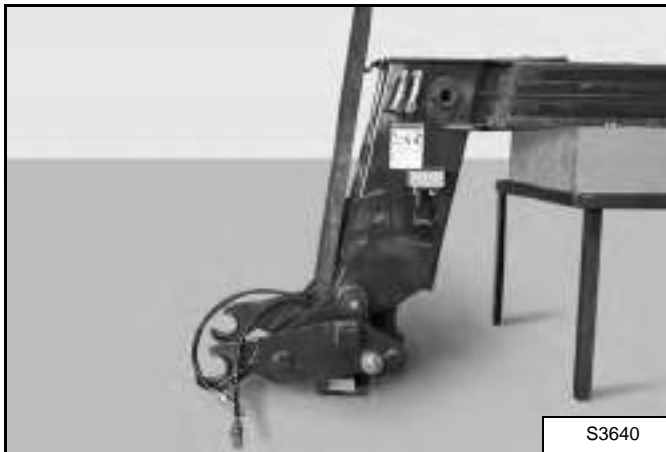

Rotate the quick tach forward fully, using a lifting hoist. Support the quick tach as shown [Figure 50-90-2].

Figure 50-90-3

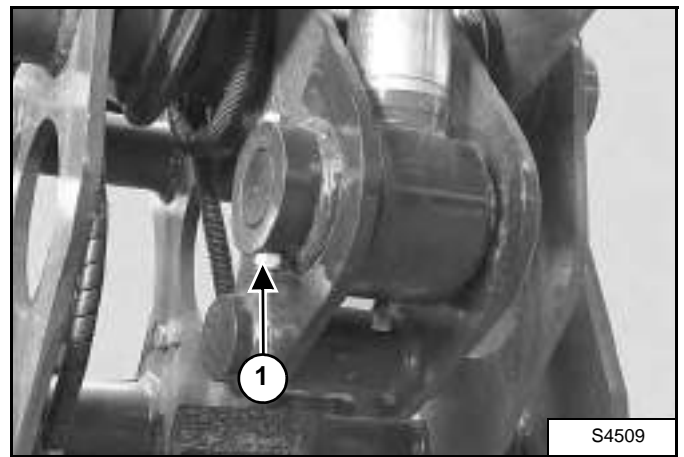

Remove the pivot pin retainer bolt (Item 1) [Figure 50-90-3].

Figure 50-90-4

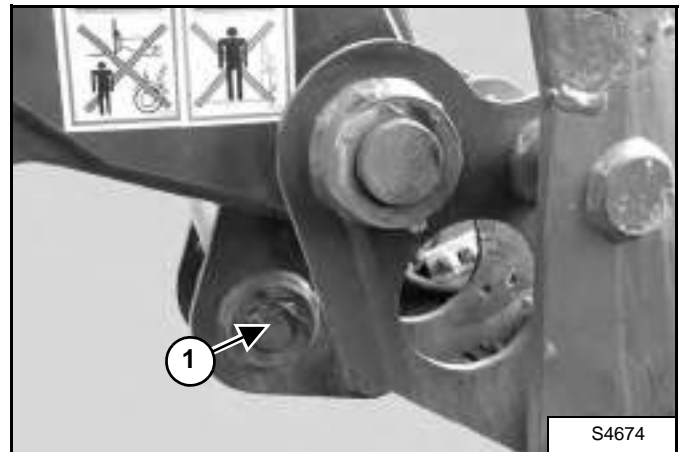

Remove the pivot pin (Item 1) [Figure 50-90-4] to release the quick tach from the tilt cylinder.

## QUICK TACH (CONT'D)

### Removal And Installation (Cont'd)

Figure 50-90-5

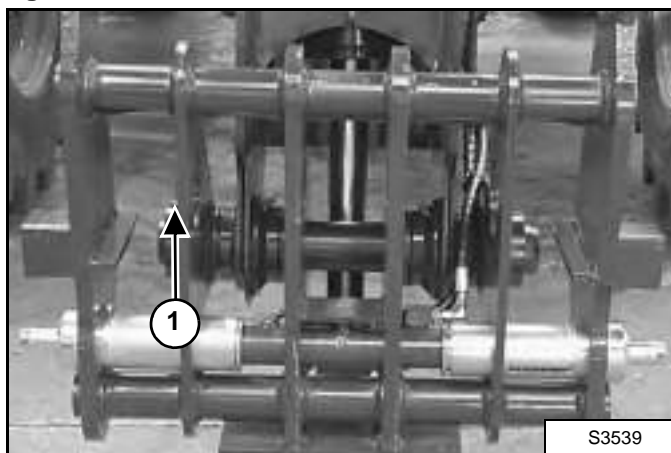

Remove the pivot pin retainer bolt (Item 1) [Figure 50-90-5].

Figure 50-90-6

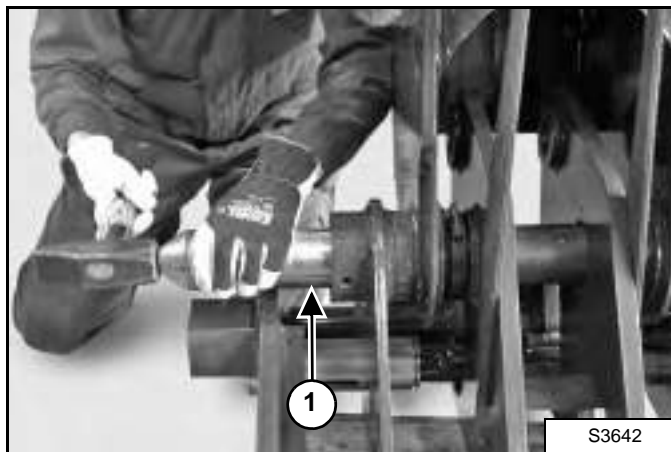

Remove the pivot pin (Item 1) [Figure 50-90-6].

Remove the quick tach.

**Installation:** Apply grease using a grease pump.



## REAR WEIGHTS

### Removal And Installation

Figure 50-100-1

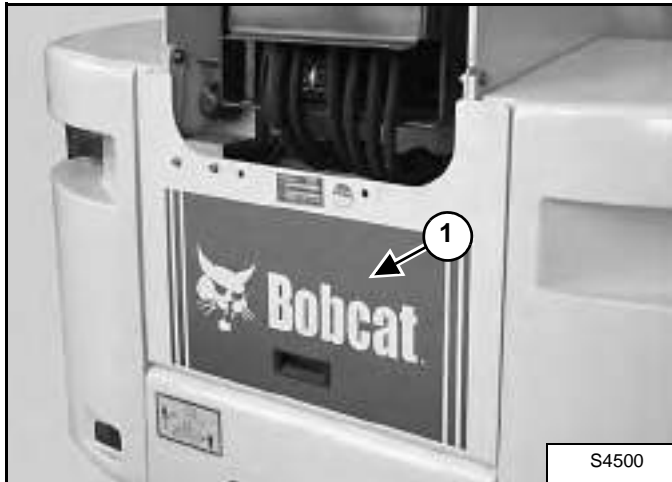

Remove the rear cover (Item 1) [Figure 50-100-1].

Figure 50-100-2

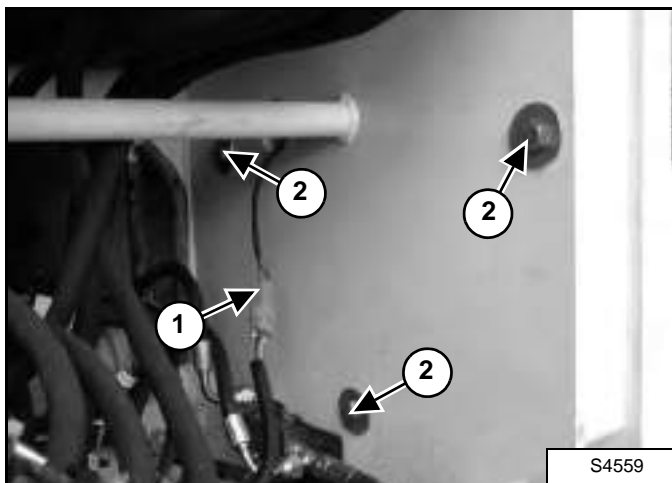

Unplug the tail light connector (Item 1) [Figure 50-100-2] from the main harness.

Remove the three weight mounting bolts (Item 2) [Figure 50-100-3].

Figure 50-100-3



Position a hoist as shown to lift and support the rear weight [Figure 50-100-3].

Figure 50-100-4



Remove the weight [Figure 50-100-4].



**Bobcat®**

## FENDER

### Removal And Installation

Figure 50-110-1

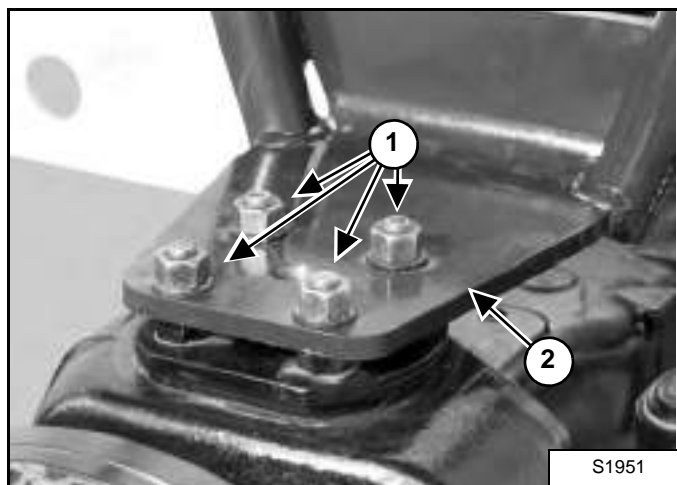

Remove the four bolts (Item 1) from the fender mount brackets (Item 2) [Figure 50-110-1].

Remove the fender.

**Installation:** Tighten the bolts to 90-100 ft.-lb. (125-140 N•m) torque.



**Bobcat®**

## FRONT WEIGHT

### Removal And Installation

Figure 50-120-1

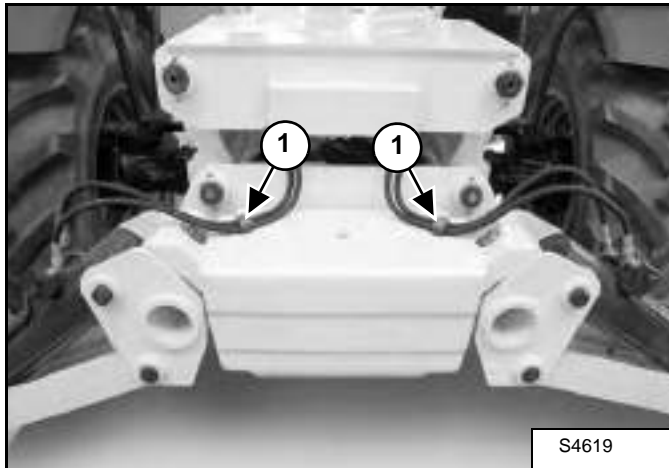

Remove the two hydraulic tubeline support blocks (Item 1) [Figure 50-120-1] by removing the screws.

Figure 50-120-2

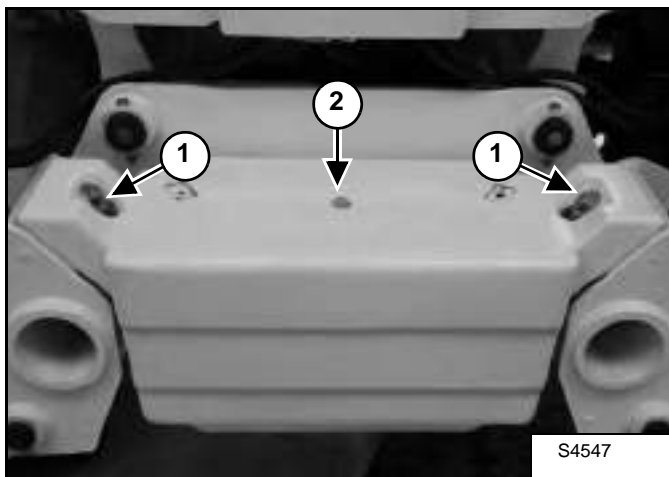

Release the front weight from the machine by removing the bolts and nuts (Item 1) [Figure 50-120-2].

Remove the plug (Item 2) [Figure 50-120-2] from the front weight.

Figure 50-120-3

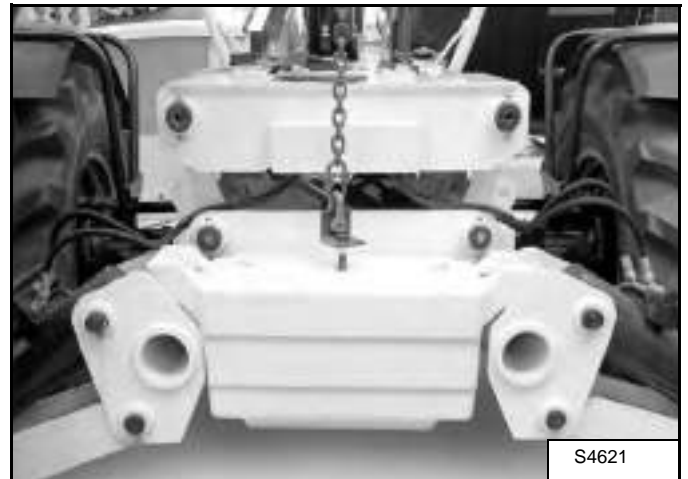

Screw a hoisting bolt in the hole of the front weight as shown in [Figure 50-120-3].

Remove the front weight from the machine by lifting it up and pulling it back.



**Bobcat®**

## DASH COVER / STEERING COLUMN COVER

### Removal And Installation

Remove the instrument panel (See "Removal And Installation" on page 60-80-1).

Remove the switch panel (See "Removal And Installation" on page 60-90-1).

**Figure 50-130-1**

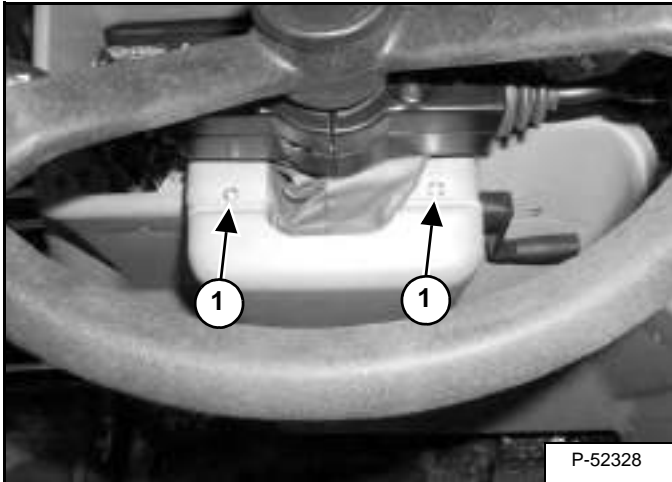

Remove the two screws (Item 1) [Figure 50-130-1] from the center of the dash cover.

**Figure 50-130-2**

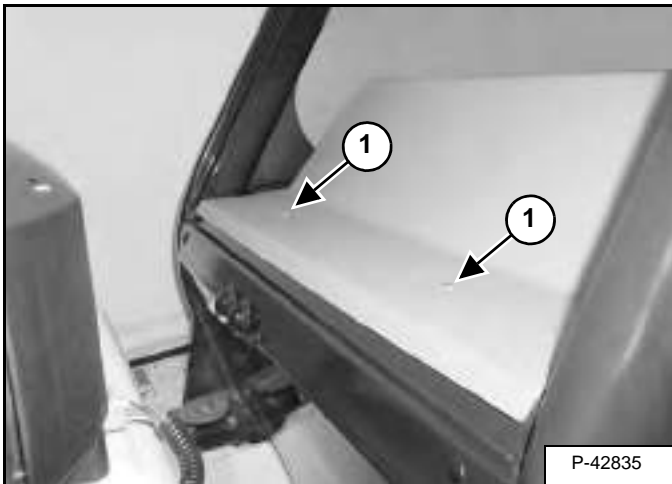

Remove the two dash cover mounting screws (Item 1) [Figure 50-130-2].

**Figure 50-130-3**

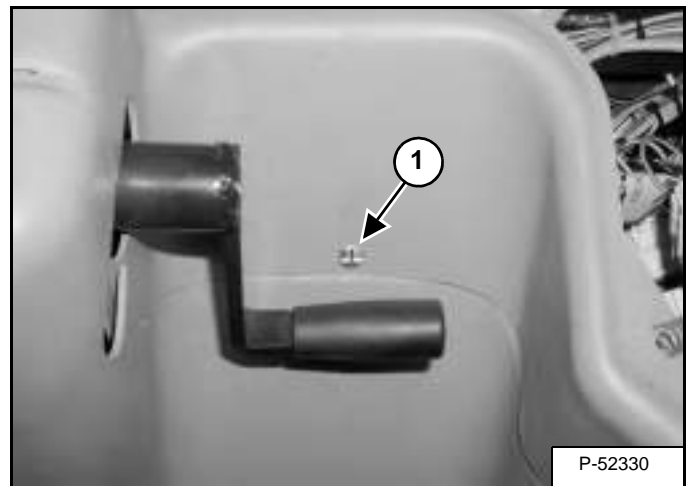

Remove the screw (Item 1) [Figure 50-130-3] from the right side of the dash.

**Figure 50-130-4**

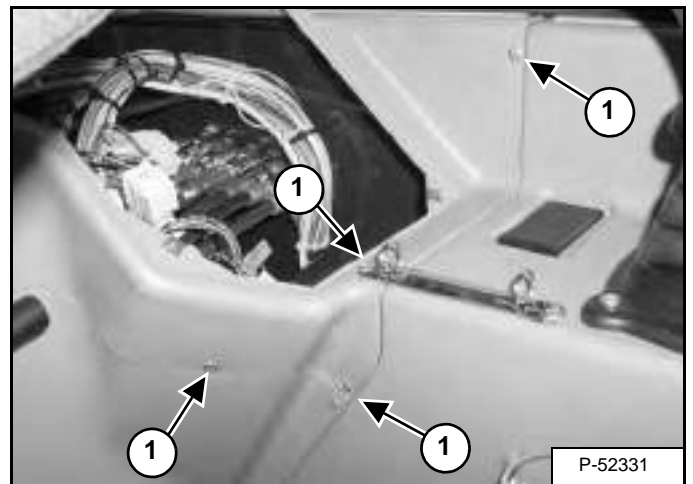

Remove the four screws (Item 1) [Figure 50-130-4] from the right side of the dash cover.

## DASH COVER / STEERING COLUMN COVER (CONT'D)

### Removal And Installation (Cont'd)

Figure 50-130-5

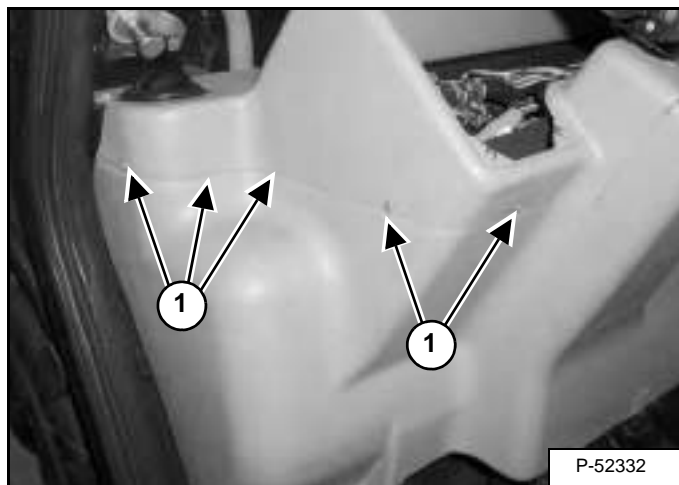

Remove the five screws (Item 1) [Figure 50-130-5] from the left side of the dash cover.

Figure 50-130-6



Lift and remove the dash cover [Figure 50-130-6].

Figure 50-130-7

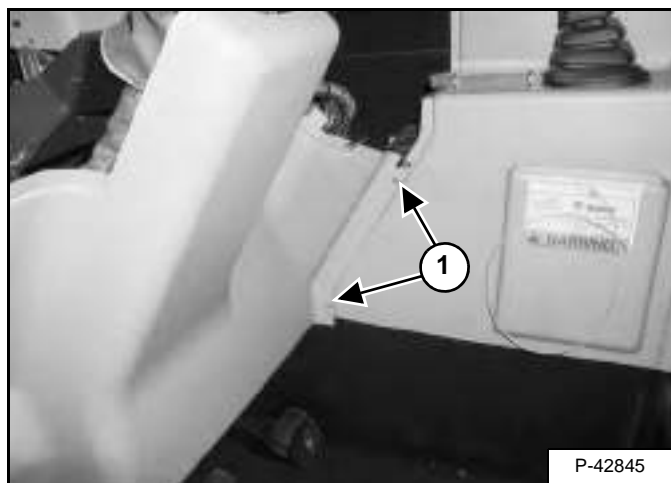

Remove the two screws (Item 1) [Figure 50-130-7] from the right side of the column cover.

Figure 50-130-8

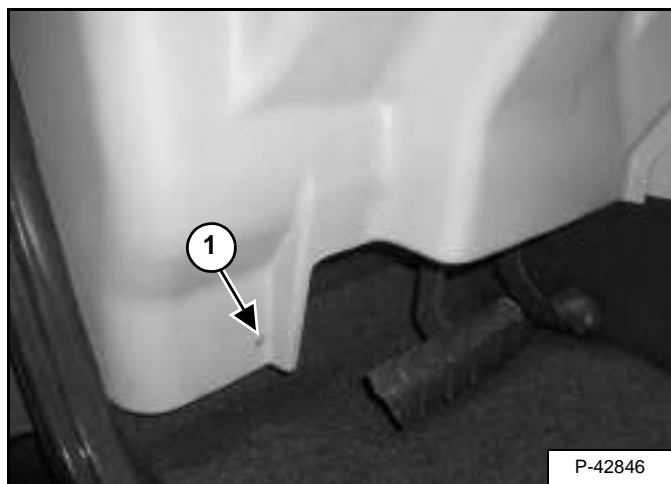

Remove the screw (Item 1) [Figure 50-130-8] from the left side of the column cover.



---

**DASH COVER / STEERING COLUMN COVER  
(CONT'D)**

**Removal And Installation (Cont'd)**

**Figure 50-130-9**



Remove the steering column cover [Figure 50-130-9].



**Bobcat®**

## JOYSTICK PANEL

### Removal And Installation

Remove the instrument panel (See "Removal And Installation" on page 60-80-1).

Remove the switch panel (See "Removal And Installation" on page 60-90-1).

Remove the dash cover / steering column cover. (See "Removal And Installation" on page 50-130-1)

**Figure 50-140-1**

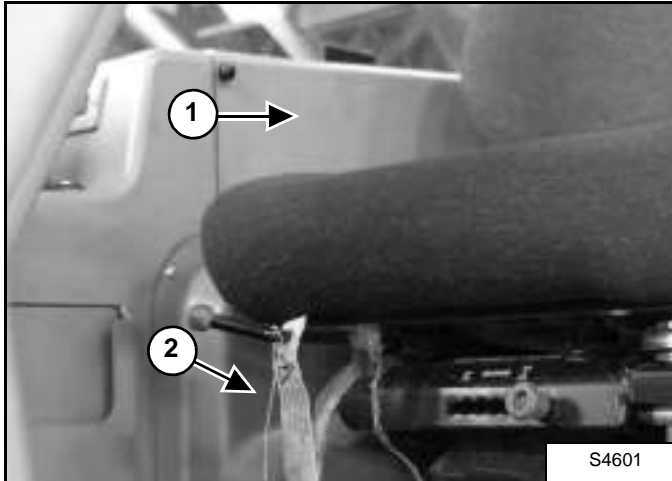

Remove the fuse box cover (Item 1) and side cover (Item 2) [Figure 50-140-1].

**Figure 50-140-2**

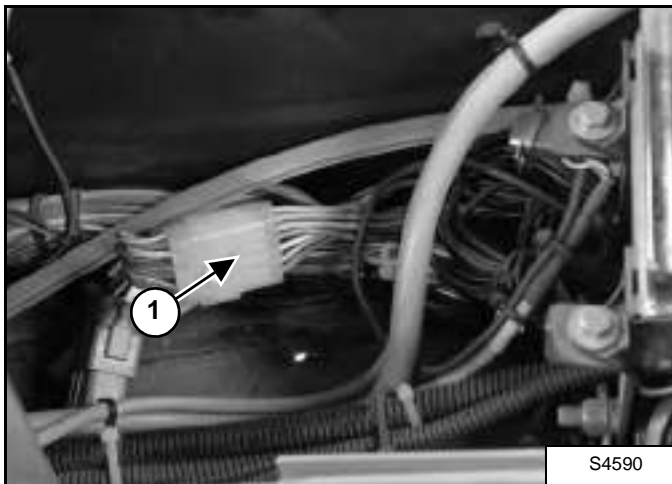

Disconnect the frame leveling connector (Item 1) [Figure 50-140-2].

**Figure 50-140-3**

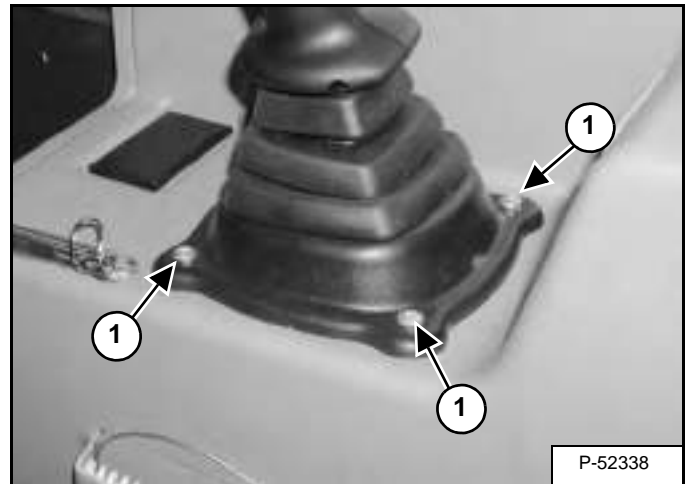

Remove the four bolts (Item 1) [Figure 50-140-3].

**Figure 50-140-4**

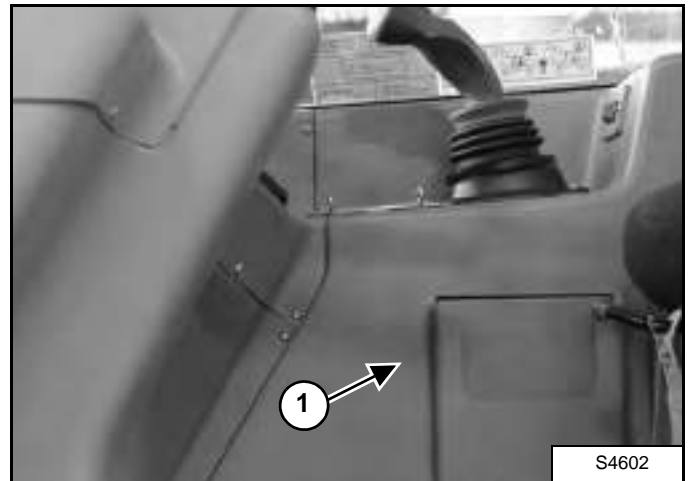

Remove the joystick panel (Item 1) [Figure 50-140-4].



**Bobcat®**

## INTERMEDIATE BOOM

### Removal of the First Intermediate Boom (T40170 & T40140)

Remove the boom tray (See "Removal And Installation" on page 50-160-1).

Remove the extension cylinder (See "Cylinder Group Removal And Installation" on page 20-40-1).

Remove the end boom (See "Removal" on page 50-40-1).

**Figure 50-150-1**

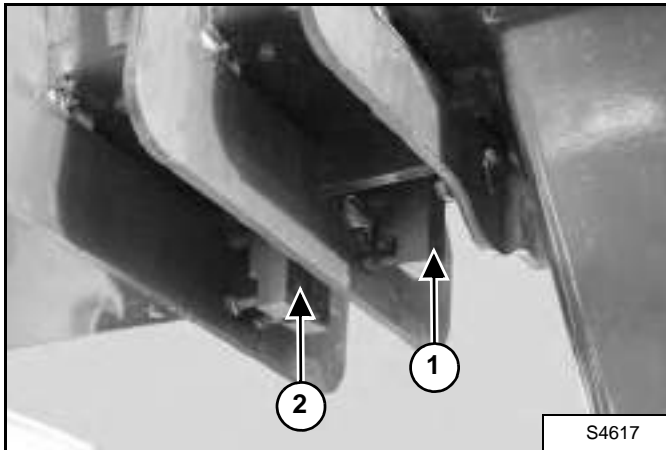

Disconnect the retraction chain at the front of the second intermediate boom (Item 1) / fixed boom (Item 2) [Figure 50-150-1].

**Figure 50-150-2**

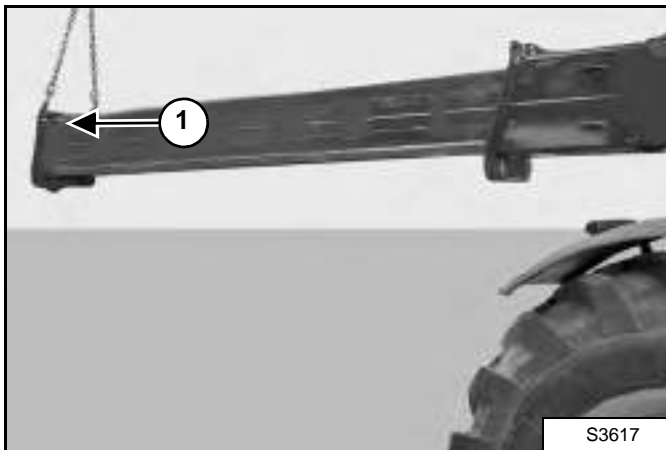

Begin sliding the first intermediate boom from the second intermediate boom / fixed boom. Before the intermediate boom is completely removed, position a hoist and a lifting strap (Item 1) [Figure 50-150-2] on the front of the boom.

Remove the front wear pads of the second intermediate boom / fixed boom (See "Removal" on page 50-50-1).

Carefully remove the intermediate boom completely.

**Figure 50-150-3**

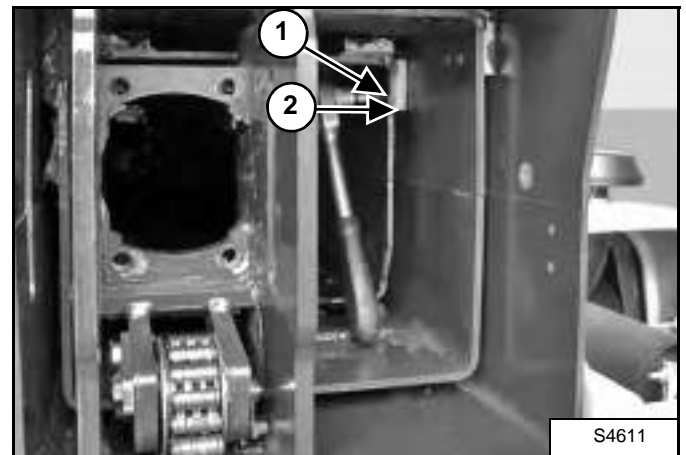

Disconnect the two screws (Item 1) and the plate (Item 2) [Figure 50-150-3] at the rear of the intermediate boom.

**Figure 50-150-4**

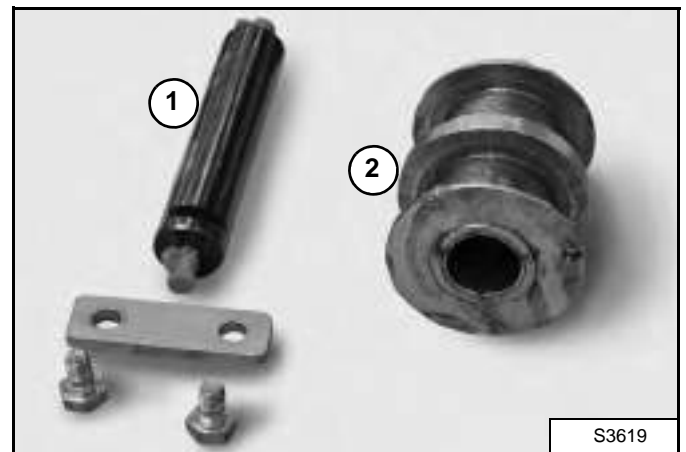

Disconnect the spindle (Item 1) and the pulley (Item 2) [Figure 50-150-4] at the rear of the intermediate boom.

Remove the rear wear pads of the first intermediate boom (See "Removal" on page 50-60-1).

## INTERMEDIATE BOOM (CONT'D)

### Installation of the First Intermediate Boom (T40170 & T40140)

Figure 50-150-5



Apply grease to the inside top and bottom corners of the second intermediate boom / fixed boom.

Install the rear wear pads on the first intermediate boom

See "Removal" on page 50-60-1

Figure 50-150-6

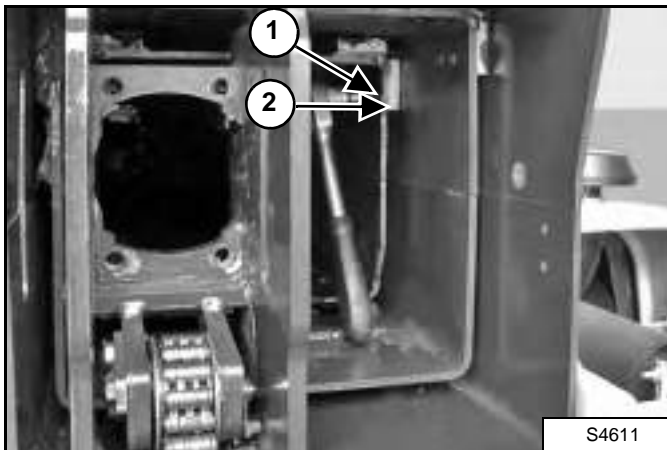

Connect the two screws (Item 1) and the plate (Item 2) [Figure 50-150-6] at the rear of the intermediate boom.

Figure 50-150-7

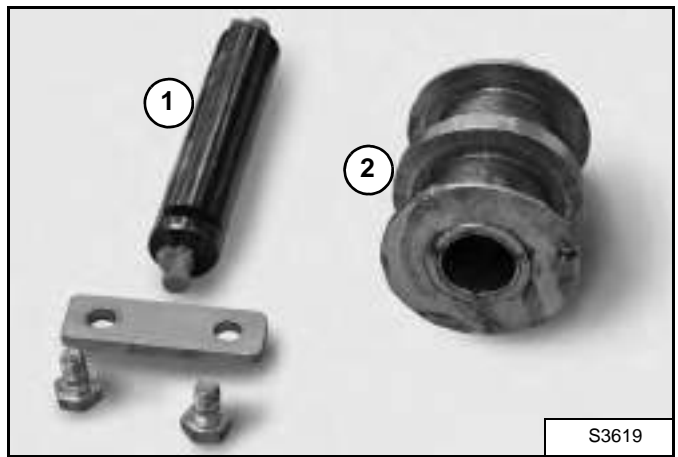

Connect the spindle (Item 1) and the pulley (Item 2) [Figure 50-150-7] at the rear of the intermediate boom.

Figure 50-150-8

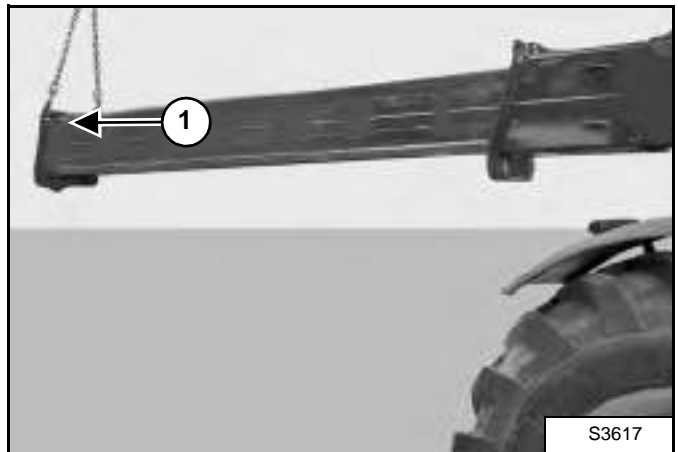

Install the first intermediate boom (Item 1) into the second intermediate boom / fixed boom (Item 2) [Figure 50-150-8] approximately 10 Inch.

Install the front wear pads on the second intermediate boom / fixed boom (See "Installation" on page 50-50-2).

Remove the hoist and lifting strap and slide the first intermediate boom fully into the second intermediate boom / fixed boom.

## INTERMEDIATE BOOM (CONT'D)

### Installation of the First Intermediate Boom (T40170 & T40140) (Cont'd)

Figure 50-150-9

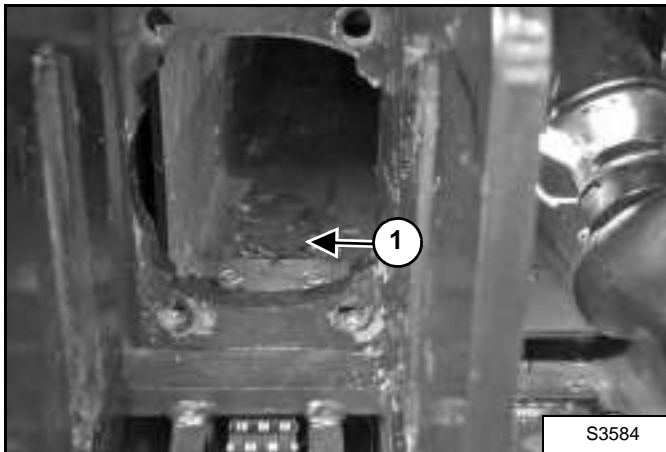

Connect the retraction chain at the front of the second intermediate boom / fixed boom (Item 1) [Figure 50-150-9].

Install the end boom (See "Installation" on page 50-40-3).

Install the extension cylinder (See "Cylinder Group Removal And Installation" on page 20-40-1).

Install the boom tray (See "Removal And Installation" on page 50-160-1).

Adjust the extension and retraction chains (See "Checking The Tension Of The Telescoping Chains Of The T40140 / T40170" on page 50-170-1).

### Removal of the Second Intermediate Boom (T40170)

Remove the first intermediate boom See "Removal of the First Intermediate Boom (T40170 & T40140)" on page 50-150-1

Figure 50-150-10

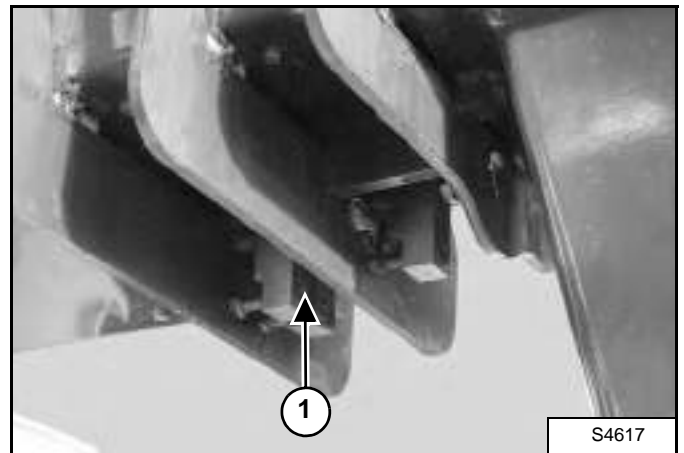

Disconnect the retraction chain at the front of the fixed boom (Item 1) [Figure 50-150-10].

Figure 50-150-11

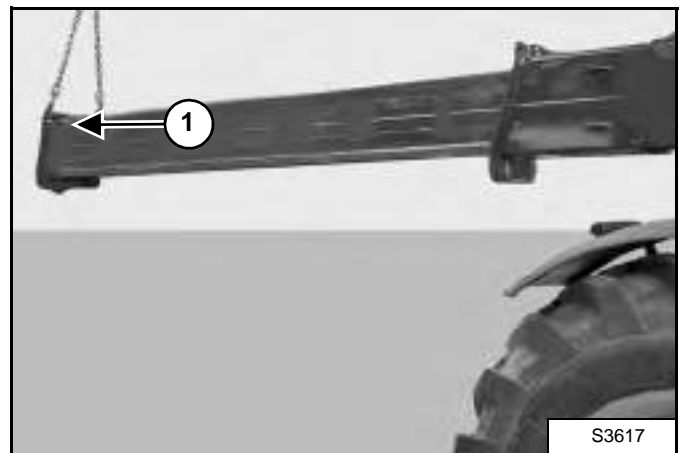

Begin sliding the intermediate boom from the fixed boom. Before the intermediate boom is completely removed, position a hoist and a lifting strap (Item 1) [Figure 50-150-11] on the front of the boom.

Remove the front wear pads of the fixed boom (See "Removal" on page 50-50-1).

Carefully remove the intermediate boom completely.

## INTERMEDIATE BOOM (CONT'D)

### Removal of the Second Intermediate Boom (T40170) (Cont'd)

Figure 50-150-12

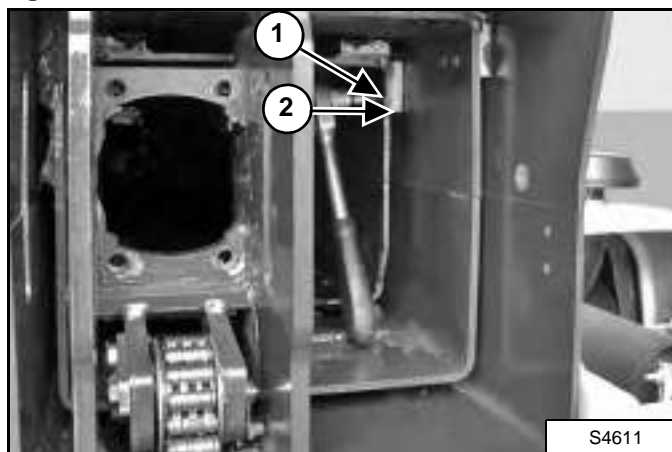

Disconnect the two screws (Item 1) and the plate (Item 2) [Figure 50-150-12] at the rear of the intermediate boom.

Figure 50-150-13

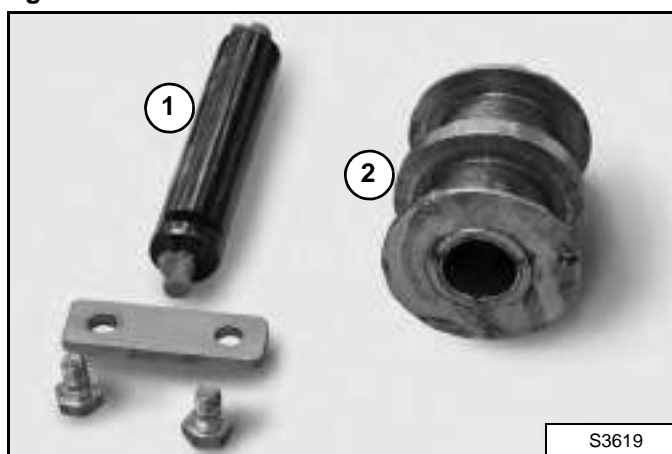

Disconnect the spindle (Item 1) and the pulley (Item 2) [Figure 50-150-13] at the rear of the intermediate boom.

Remove the rear wear pads of the intermediate boom (See "Removal" on page 50-60-1).

### Installation of the Second Intermediate Boom (T40170)

Figure 50-150-14



Apply grease to the inside top and bottom corners of the fixed boom.

Install the rear wear pads on the intermediate boom (See "Installation" on page 50-60-1).

Figure 50-150-15

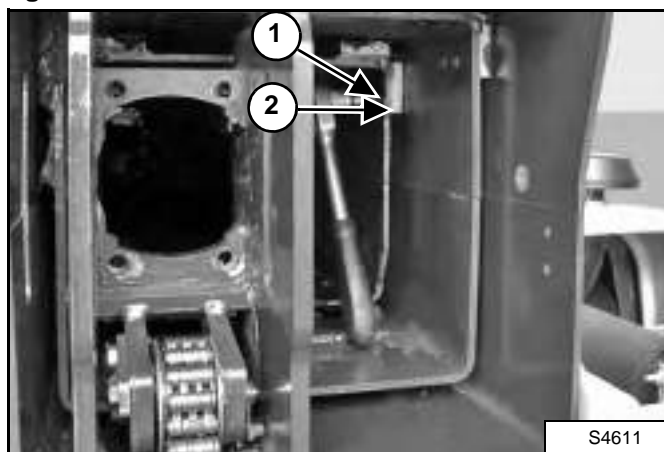

Connect the two screws (Item 1) and the plate (Item 2) [Figure 50-150-15] at the rear of the intermediate boom.



## INTERMEDIATE BOOM (CONT'D)

### Installation of the Second Intermediate Boom (T40170) (Cont'd)

Figure 50-150-16

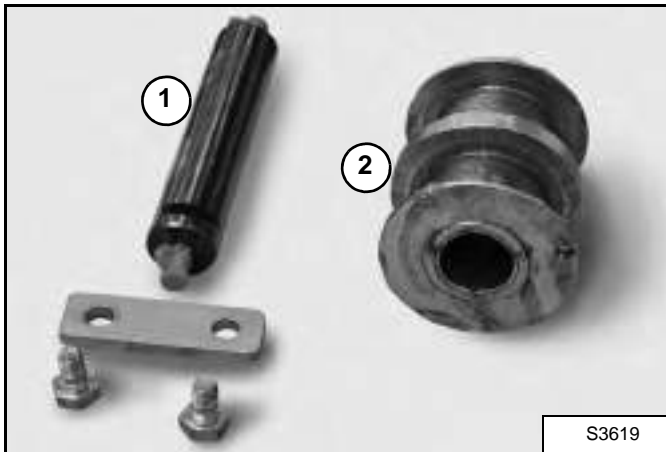

Connect the spindle (Item 1) and the pulley (Item 2) [Figure 50-150-16] at the rear of the intermediate boom.

Figure 50-150-17

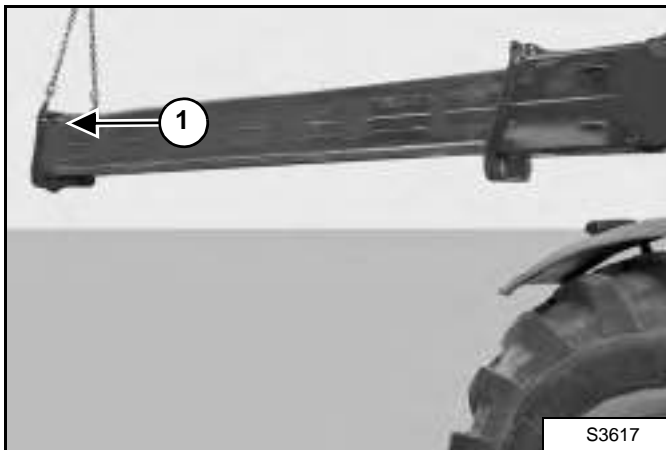

Install the intermediate boom (Item 1) into the fixed boom (Item 2) [Figure 50-150-17] approximately 10 Inch.

Install the front wear pads on the fixed boom (See "Installation" on page 50-50-2).

Remove the hoist and lifting strap and slide the first intermediate boom fully into the fixed boom.

Figure 50-150-18

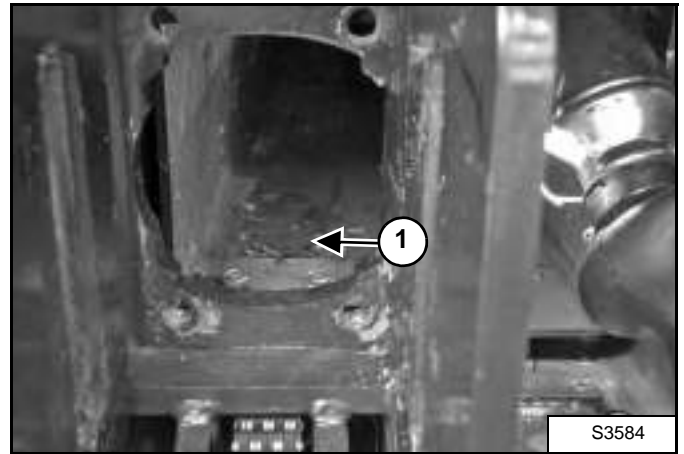

Connect the retraction chain at the front of the fixed boom (Item 1) [Figure 50-150-18].

Install the first intermediate boom (See "Installation of the First Intermediate Boom (T40170 & T40140)" on page 50-150-2).

Adjust the extension and retraction chains

See "Checking The Tension Of The Telescoping Chains Of The T40140 / T40170" on page 50-170-1



**Bobcat®**

## BOOM TRAY

### Removal And Installation

Figure 50-160-1

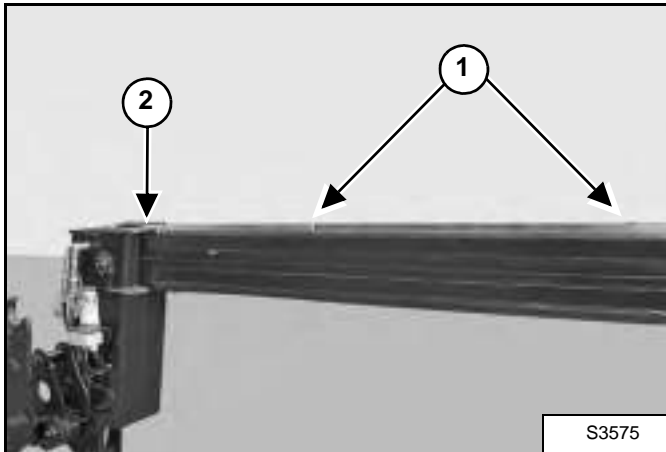

Fully extend the boom and remove the two attachment screws (Item 1) located on top of the last element, except for the screw (Item 2) [Figure 50-160-1] located at the head of the boom.

Figure 50-160-2

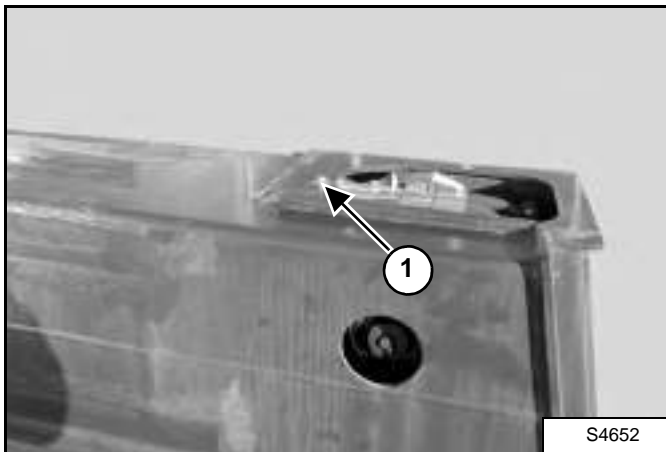

Retract the boom gently and remove the remaining screw (Item 1) [Figure 50-160-2].

Figure 50-160-3

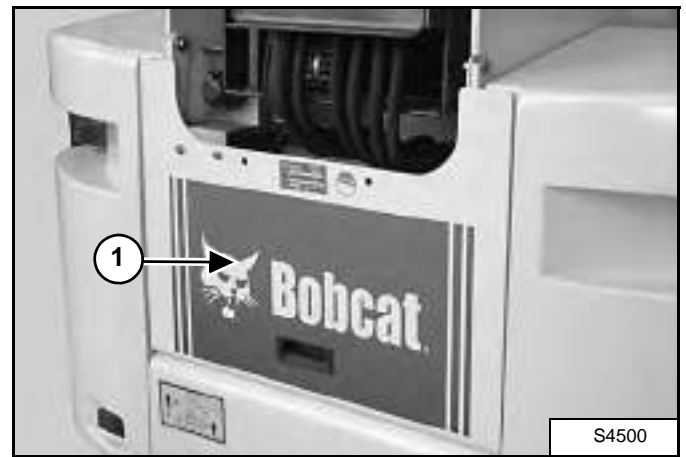

Remove the rear cover (Item 1) [Figure 50-160-3] from the machine.

Figure 50-160-4

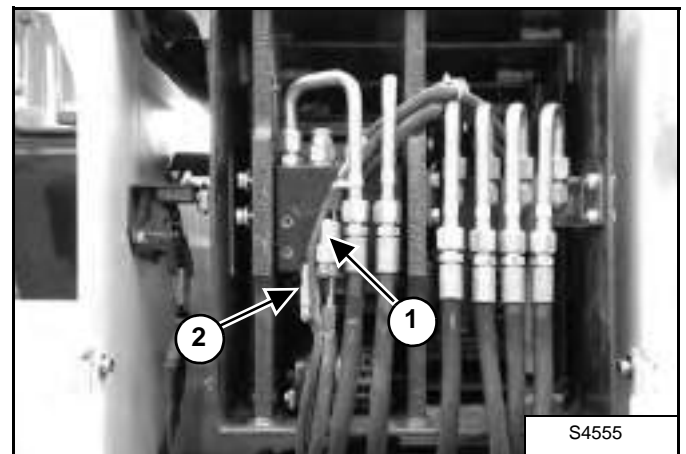

Disconnect the light harness connector (Item 1) (If equipped) and the secondary auxiliary harness connector (Item 2) [Figure 50-160-4] (If Equipped) at the rear of the boom.

## BOOM TRAY (CONT'D)

### Removal And Installation (Cont'd)

Figure 50-160-5

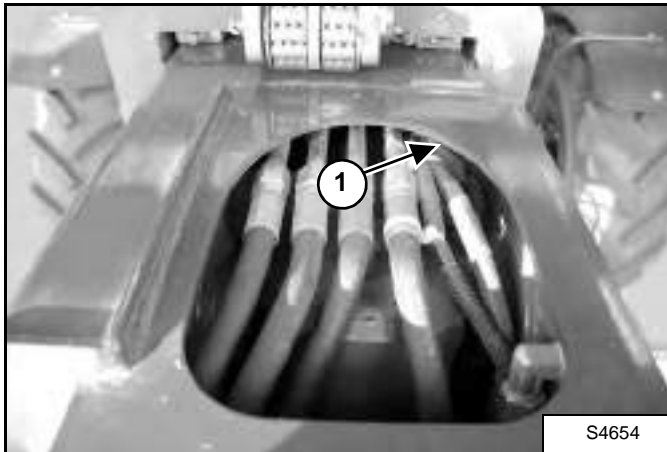

Disconnect the two connectors (Item 1) [Figure 50-160-5] at the front of the boom (If Equipped).

**NOTE:** Mark all hoses for correct installation.

# IMPORTANT

When repairing hydrostatic and hydraulic systems, clean the work area before disassembly and keep all parts clean. Always use caps and plugs on hoses, tubelines and ports to keep dirt out. Dirt can quickly damage the system.

I-2003-0888

Figure 50-160-6

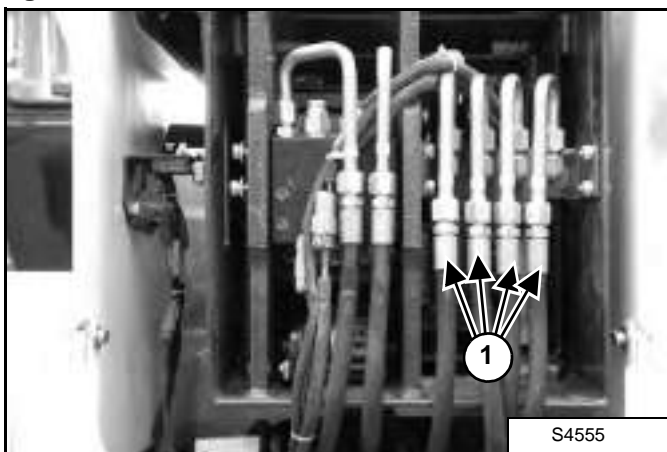

Disconnect the four hydraulic hoses (Item 1) [Figure 50-160-6] from the tubelines at the rear of the boom.

Figure 50-160-7

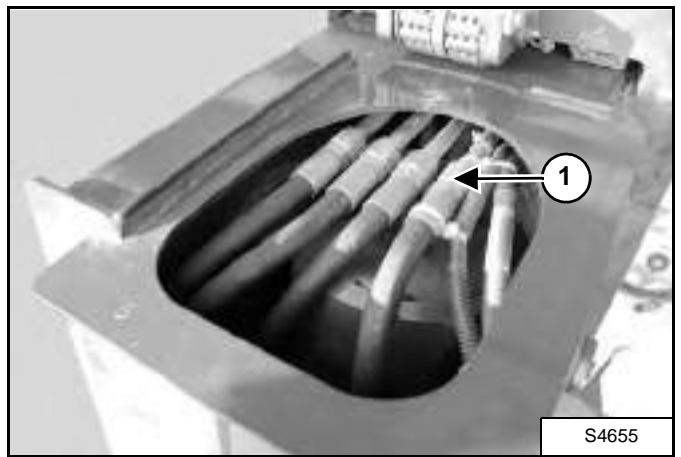

Disconnect the four hydraulic hoses (Item 1) [Figure 50-160-7] at the front of the boom.

Figure 50-160-8

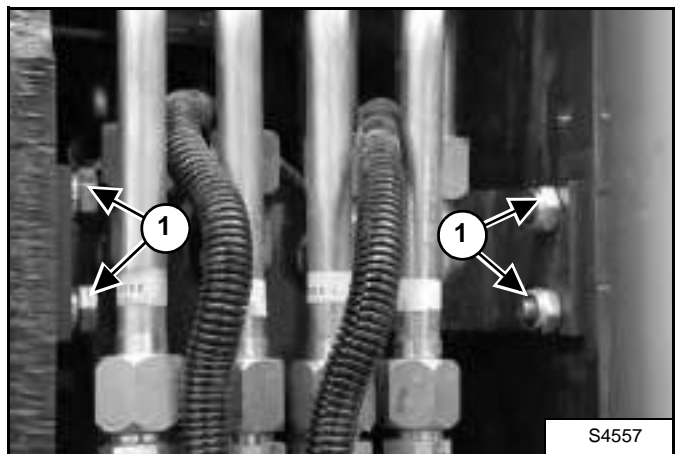

Remove the four attachment screws (Item 1) [Figure 50-160-8] at the rear of the boom.

## BOOM TRAY (CONT'D)

### Removal And Installation (Cont'd)

Figure 50-160-9

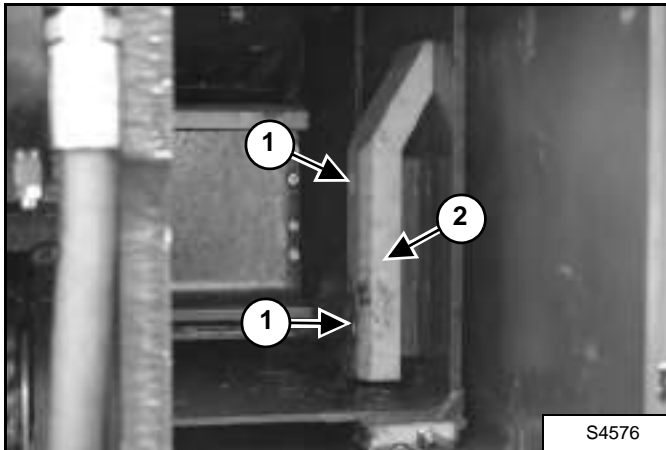

Remove the two attachment screws (Item 1) and remove the block (Item 2) [Figure 50-160-9].

Figure 50-160-10

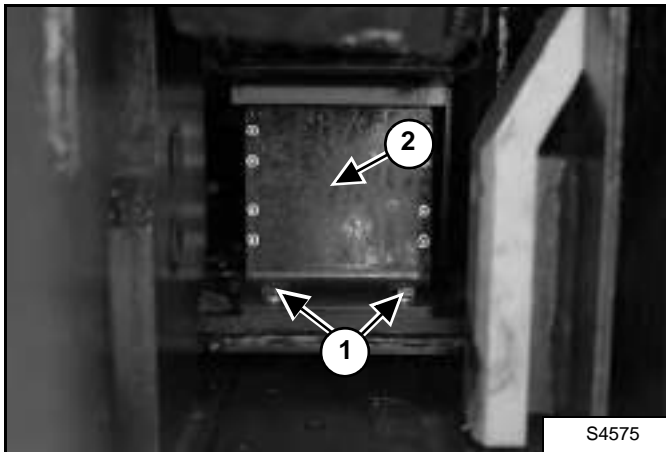

Remove the two attachment screws (Item 1) and skid (Item 2) [Figure 50-160-10].

Figure 50-160-11

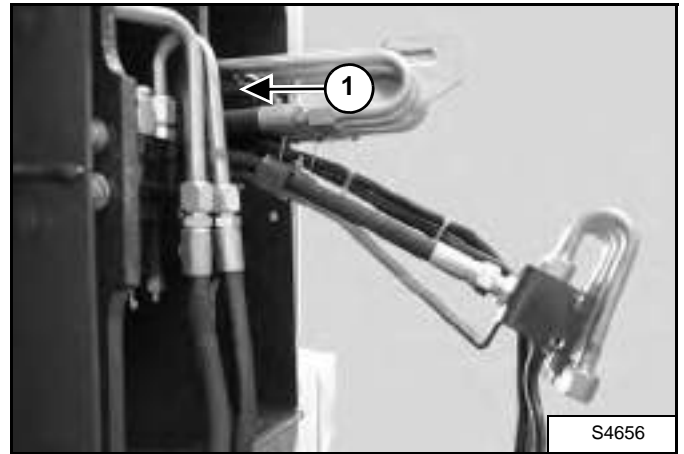

Extract the boom tray (Item 1) [Figure 50-160-11] through the rear of the boom.

Figure 50-160-12

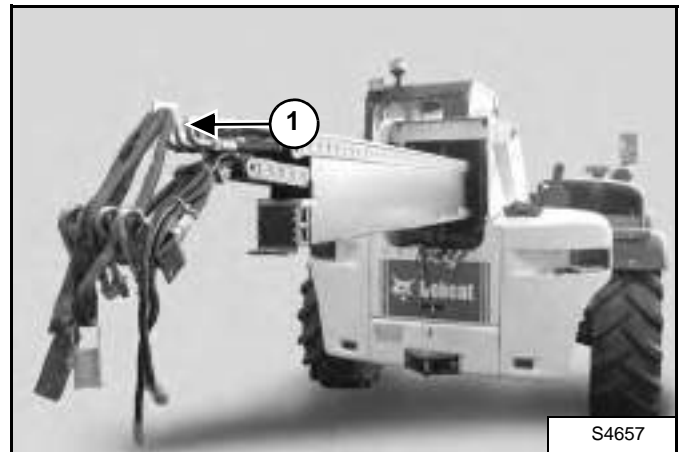

Extend the boom tray by pulling at the end of the tubelines (Item 1) [Figure 50-160-12].

---

## BOOM TRAY (CONT'D)

### Removal And Installation (Cont'd)

Figure 50-160-13

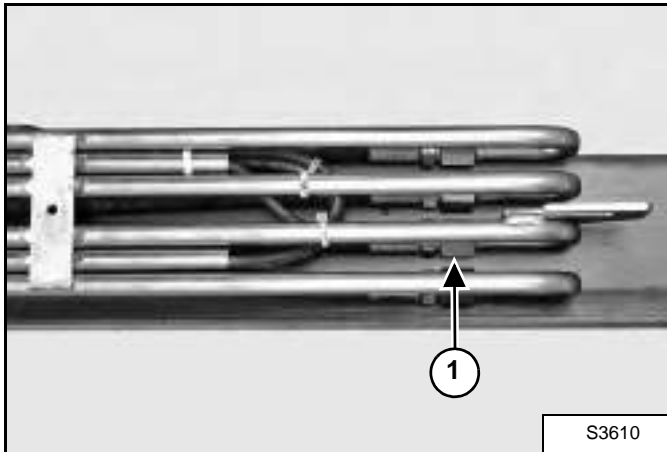

Disconnect the tubelines (Item 1) [Figure 50-160-13].

## CHAIN CHECKING AND ADJUSTING PROCEDURE

### Checking The Tension Of The Telescoping Chains Of The T40140 / T40170

Position the booms against the stops.

Return chains:

**Figure 50-170-1**

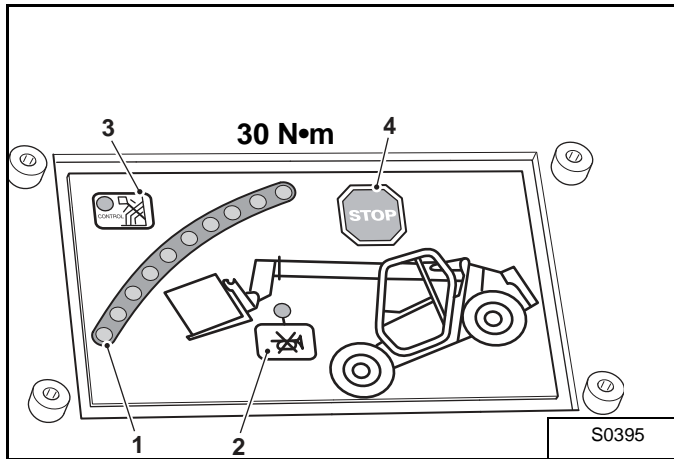

Unscrew the locknuts (Items 1 & 2) [Figure 50-170-1].

Check the tightness of the tension screw at the bottom of the boom (Item 3) [Figure 50-170-1]. The correct torque is 18 ft.-lb. (30 N•m).

Progressively tighten each screw (Items 3 & 4) [Figure 50-170-1] making sure to keep the tensioner perfectly parallel to the belt of the element.

Re-tighten the lock-nuts.

Extension chains:

**Figure 50-170-2**

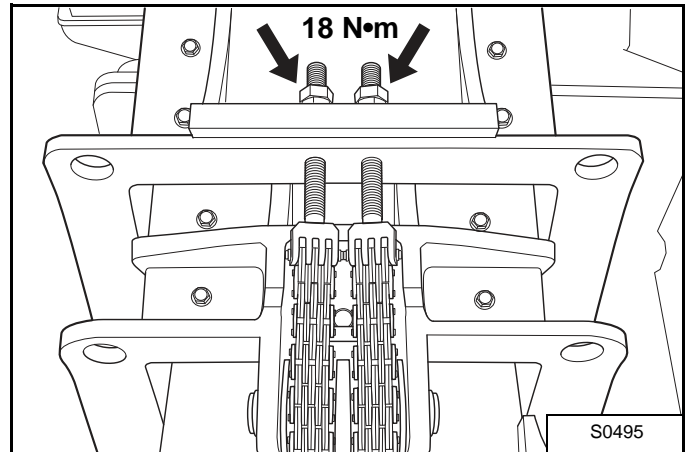

Unscrew the locknuts [Figure 50-170-2].

Check the tightness of the two tension screws on top of the boom [Figure 50-170-2]. The correct torque is 5 ft.-lb. (18 N•m).

Each bolt is gradually tightened.

Re-tighten the lock-nuts.

Extend and retract the telescope equipment three times after each adjustment.

The nuts should screw freely onto the tensioners.

Screws and nuts must be lubricated. Lubricate as needed.

We recommend you contact your Bobcat dealer when adjusting or removing chain links.

**Figure 50-170-3**

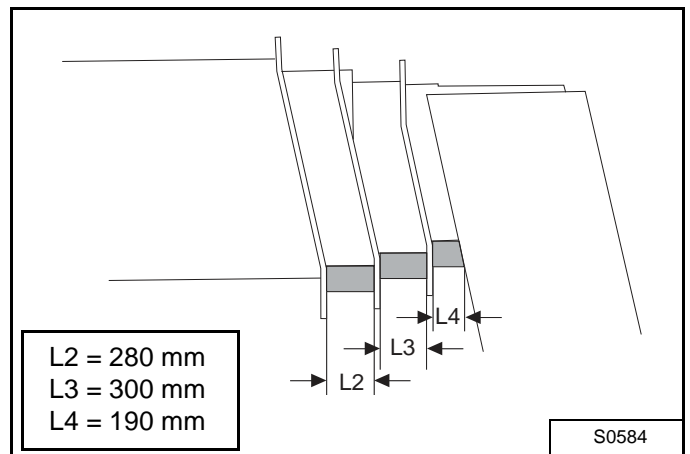

Position the booms of the T40170 against three blocks with the lengths L2, L3 and L4 (as shown in [Figure 50-170-3]).

## CHAIN CHECKING AND ADJUSTING PROCEDURE (CONT'D)

### Checking The Tension Of The Telescoping Chains Of The T40140 / T40170 (Cont'd)

Figure 50-170-4

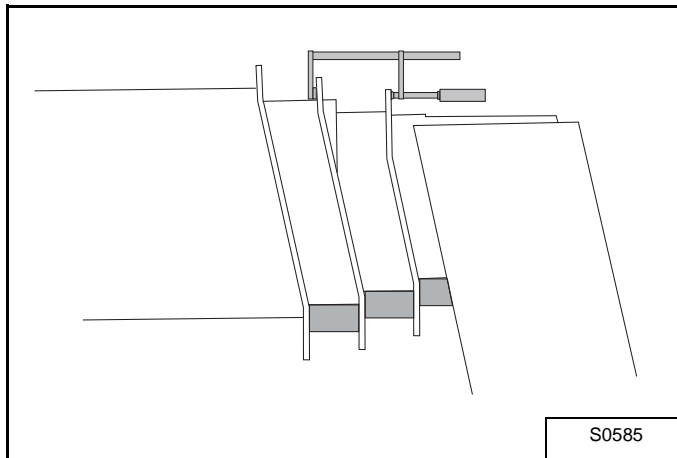

Install two clamps in order to prevent extending of the telescopic boom during tightening of the chain tension screws [Figure 50-170-4].

Return chains:

Figure 50-170-5

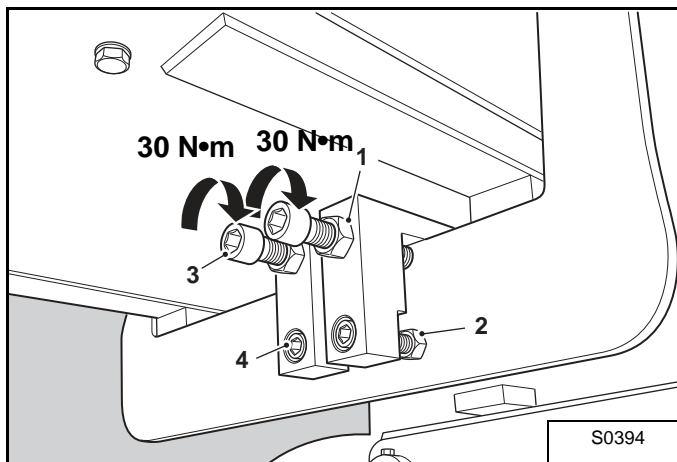

Boom 01:  
Unscrew the locknuts (Items 1 & 2) and check the tightness of the two tension screws (Item 3) [Figure 50-170-5]. The correct torque is 18 ft.-lb. (30 N•m).

Progressively tighten each screw (Items 3 & 4) [Figure 50-170-5] making sure to keep the tensioner perfectly parallel to the belt of the element.

Re-tighten the lock-nuts.

Figure 50-170-6

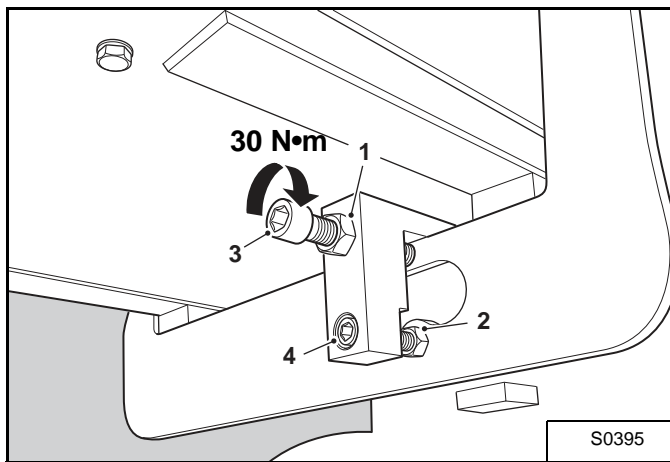

Boom 02:  
Unscrew the locknuts (Items 1 & 2) and check the tightness of the tension screw (Item 3) [Figure 50-170-6]. The correct torque is 30 N•m.

Progressively tighten each screw (Items 3 & 4) [Figure 50-170-6] making sure to keep the tensioner perfectly parallel to the belt of the element.

Re-tighten the lock-nuts.

Extension chains:

Unscrew the locknuts [Figure 50-170-7].

Figure 50-170-7

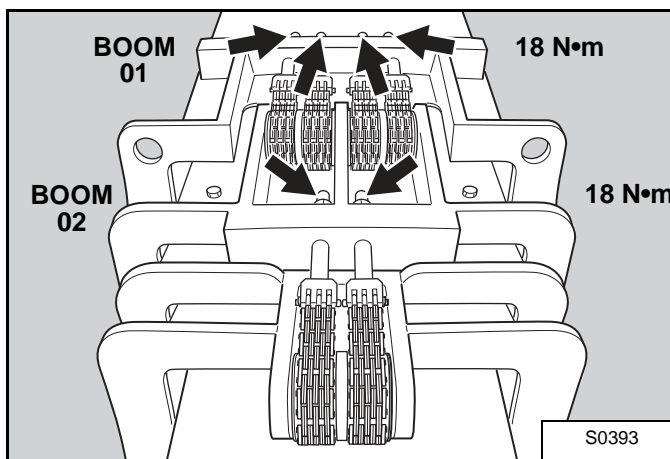

Boom 01:  
Check the tightness of the four tension screws on top of the boom [Figure 50-170-7]. The correct torque is 5 ft.-lb. (18 N•m). Each bolt is gradually tightened.

Boom 02:  
Check the tightness of the two tension screws on top of the boom [Figure 50-170-7]. The correct torque is 5 ft.-lb. (18 N•m). Each bolt is gradually tightened.

Re-tighten the lock-nuts.



## CHAIN CHECKING AND ADJUSTING PROCEDURE (CONT'D)

### Checking The Tension Of The Telescoping Chains Of The T40140 / T40170 (Cont'd)

Extend and retract the telescope equipment three times after each adjustment.

The nuts should screw freely onto the tensioners.

Screws and nuts must be lubricated. Lubricate as needed.

We recommend you contact your Bobcat dealer when adjusting or removing chain links.

Checking the wear of telescoping chains

Measure the extender chains (external).

Take the measurement when the boom is completely deployed (telescoped) in the horizontal position.

Using a vernier caliper measure the length  $L$  of 11 axes at the outside of the link pin

**Figure 50-170-8**

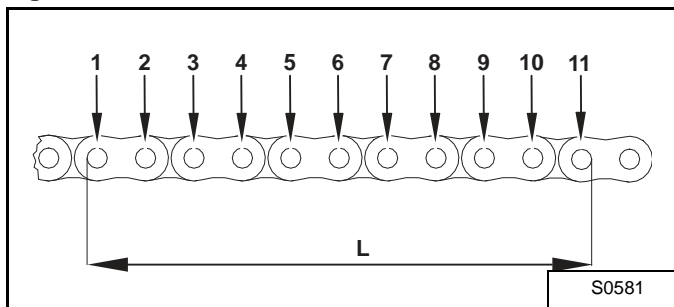

The measurement must be taken as shown in the diagram, at the outside of the pins of the chain.

The wear is considered normal as long as  $L$  is less than 6.7 in. (169,50 mm).

If  $L$  is equal to or more than that value, the chains, pins, rollers, tension rods and attachment screws **MUST** be replaced.

We recommend you contact your Bobcat dealer when replacing chains, rollers and axes.

Each time you measure  $L$ , write down the date it is checked and the number of hours on the machine.



**Bobcat®**

---

## **STABILIZER FRAME**

### **Removal**

For the removal of the stabilizer frame, perform all steps  
(See "Removal" on page 40-30-1).



**Bobcat®**

---

## ELECTRICAL SYSTEM AND ANALYSIS

ALTERNATOR. . . . .	60-30-1
Adjusting The Alternator Belt . . . . .	60-30-2
Removal And Installation. . . . .	60-30-1
BATTERY . . . . .	60-20-1
Removal And Installation. . . . .	60-20-1
Servicing . . . . .	60-20-2
Using A Booster Battery (Jump Starting) . . . . .	60-20-3
BRAKE LIGHT SWITCH. . . . .	60-100-1
Adjustment . . . . .	60-100-1
Removal And Installation. . . . .	60-100-1
ELECTRICAL SYSTEM INFORMATION . . . . .	60-10-1
Checking The Battery Fluid Level . . . . .	60-10-1
Checking The State of Electric Connections . . . . .	60-10-2
Checking The State of Fuses, Diodes And Relays . . . . .	60-10-1
Checking The Working Order of Controls, Lighting And Signalling. . . . .	60-10-2
Description . . . . .	60-10-1
Fuses And Diodes. . . . .	60-10-4
Fuses, Diodes & Relays . . . . .	60-10-3
Relays . . . . .	60-10-4
FRAME LEVEL SPEED SWITCH. . . . .	60-170-1
Description . . . . .	60-170-1
Disassembly And Assembly . . . . .	60-170-3
Installation. . . . .	60-170-2
Removal . . . . .	60-170-1
FRONT WIPER MOTOR. . . . .	60-110-1
Removal And Installation. . . . .	60-110-1
INCHING SWITCH . . . . .	60-150-1
Adjustment . . . . .	60-150-1
Removal And Installation. . . . .	60-150-1
INSTRUMENT PANEL . . . . .	60-80-1
Removal And Installation. . . . .	60-80-1
LIGHTS. . . . .	60-60-1
Front Light Removal And Installation. . . . .	60-60-2
Rear Light Removal And Installation. . . . .	60-60-1
JOYSTICK . . . . .	60-180-1
Removal And Installation. . . . .	60-180-1

**ELECTRICAL  
SYSTEM AND  
ANALYSIS**

**Continued On Next Page**

---

## ELECTRICAL SYSTEM AND ANALYSIS (CONT'D)

PEDAL ASSEMBLY .....	60-140-1
Disassembly And Assembly .....	60-140-2
Removal And Installation .....	60-140-1
REAR WIPER MOTOR .....	60-130-1
Removal And Installation .....	60-130-1
SERVICE SOFTWARE .....	60-160-1
Calibrate Creep Potentiometer .....	60-160-7
Calibrate Inch Pedal .....	60-160-5
Connecting The Laptop Computer .....	60-160-1
Entering The Service Software .....	60-160-2
Monitor Screen .....	60-160-3
Program / Update Susmic Controller .....	60-160-8
Warnings Screen .....	60-160-4
STARTER .....	60-40-1
Assembly / disassembly .....	60-40-2
Removal And Installation .....	60-40-1
SWITCH PANEL .....	60-90-1
Removal And Installation .....	60-90-1
TOP WIPER MOTOR .....	60-120-1
Removal And Installation .....	60-120-1
TRAVEL / SIGNAL LEVER .....	60-70-1
Removal And Installation .....	60-70-1

## ELECTRICAL SYSTEM INFORMATION

### Description

The telescopic handler has a 12 volt, negative ground alternator charging system.

The electrical system is protected by fuses located in the cab on the right hand side console and those located in the engine compartment. The fuses will protect the electrical system when there is an electrical overload. The reason for the overload must be found before starting the engine again.

### Checking The Battery Fluid Level

Figure 60-10-1

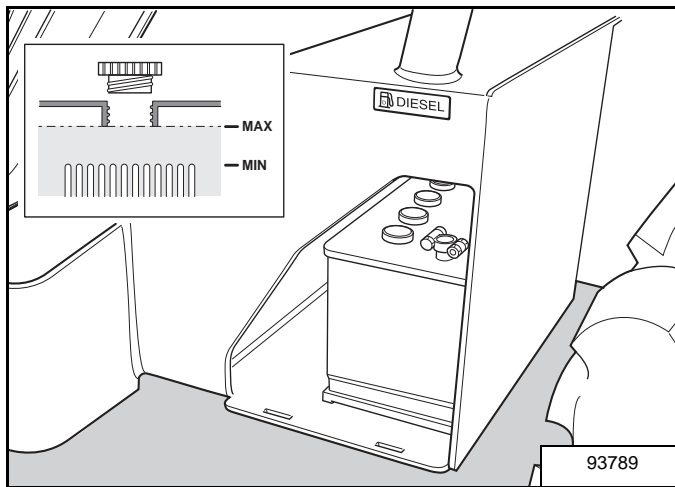

1. Use the cab key to open the battery compartment.
2. Unscrew and remove the caps from the battery cells.
3. Use a small mirror and an electric torch, or remove the battery from the compartment to check the level of the liquid.
4. Top up if necessary by adding distilled water up to the lower edge of the inner tube (See detail on [Figure 60-10-1]).

**NOTE:** Use only distilled water to top up the fluid level. The level of liquid should not exceed the top of the internal elements.

**! WARNING**

**Batteries contain acid which burns eyes and skin on contact. Wear goggles, protective clothing and rubber gloves to keep acid off body.**

**In case of acid contact, wash immediately with water. In case of eye contact get prompt medical attention and wash eye with clean, cool water for at least 15 minutes.**

**If electrolyte is taken internally drink large quantities of water or milk! DO NOT induce vomiting. Get prompt medical attention.**

W-2065-1296

### Checking The State of Fuses, Diodes And Relays

The purpose of this operation is to keep the machine properly maintained and to prevent possible damage or accidents.

**NOTE:** Replace any faulty fuse, diode or relay immediately even if the function that it protects does not seem important. This applies even over and above the recommended frequency.

## ELECTRICAL SYSTEM INFORMATION (CONT'D)

### Checking The Working Order of Controls, Lighting And Signalling

The fuse box is located beside the seat, under the cover indicated in [Figure 60-10-2].

Figure 60-10-2

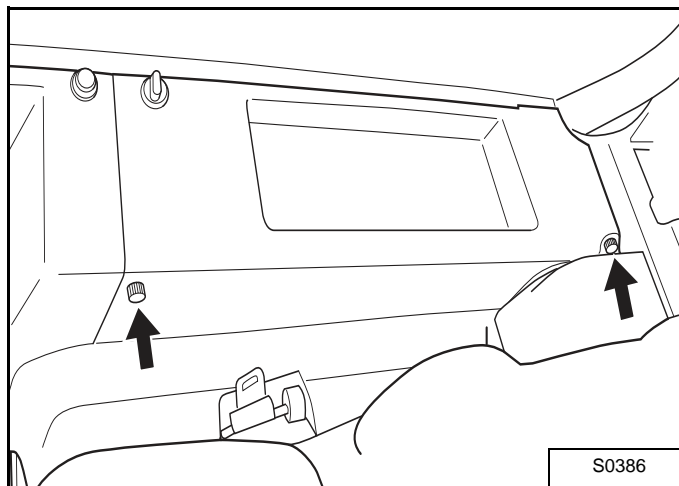

The two fuses and relay for preheating and starting the engine are located in the engine compartment, as indicated in the lower part of [Figure 60-10-2].

The purpose of this operation is to keep the machine properly maintained and to prevent possible damage or accidents.

**NOTE: Replace or repair immediately any faulty component even if its function does not seem “important”. This applies even over and above the recommended frequency.**

### Checking The State of Electric Connections

The purpose of this operation is to keep the machine properly maintained and to prevent possible damage or accidents.



# ELECTRICAL SYSTEM INFORMATION (CONT'D)

## Fuses, Diodes & Relays

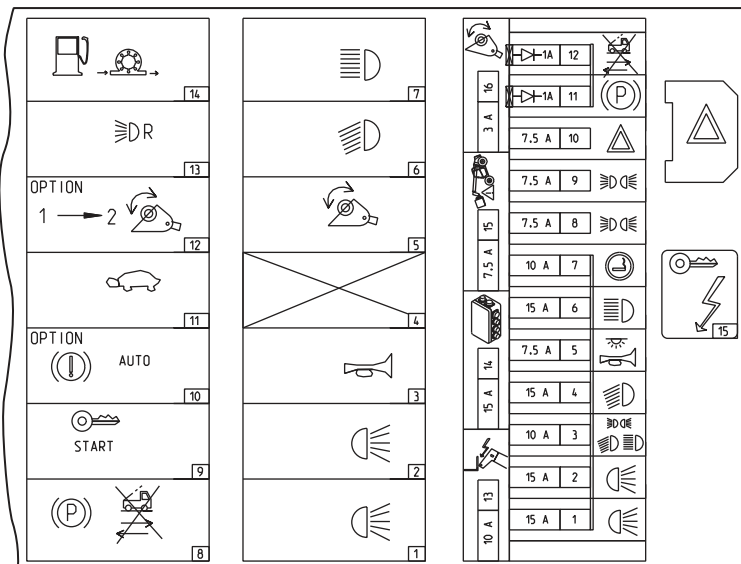
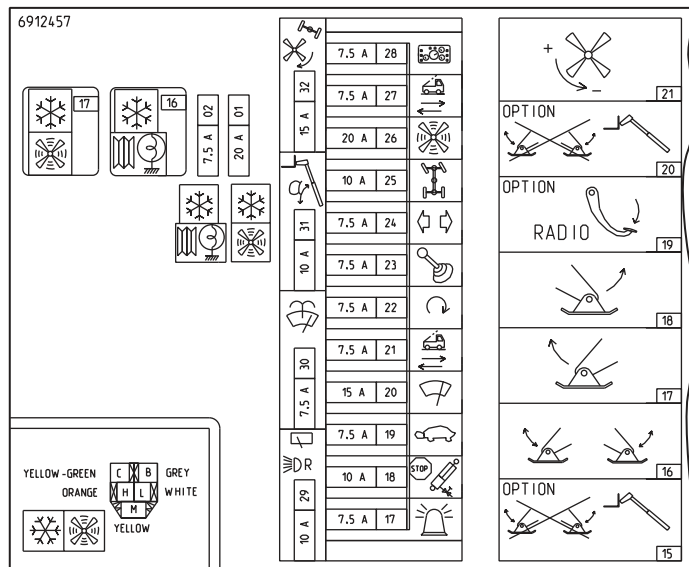

**E18**

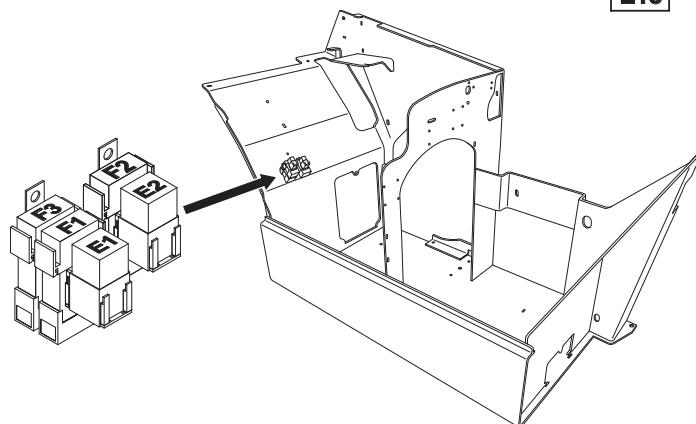

S0526

## ELECTRICAL SYSTEM INFORMATION (CONT'D)

### Fuses And Diodes

REFERENCE	GAUGE	FUNCTION PROTECTED
1	15 A	Front work lights
2	15 A	Rear work lights
3	10 A	Lighting and full-beam control
4	15 A	Headlamps
5	7.5 A	Road alarm and ceiling light
6	15 A	Full-beam
7	10 A	Cigarette lighter
8	7.5 A	Left side-lights
9	7.5 A	Right side-lights
10	7.5 A	Hazard warning lights
11	DIODE 1 A	Parking brake
12	DIODE 1 A	Advance safety if parking brake tight
13	10 A	Second hydraulic function on boom (option)
14	15 A	Joystick control box
15	7.5 A	Stability indicator and fuel pump
16	3 A	Hydraulic function on boom
17	7.5 A	Rotating beacon (option)
18	10 A	Brake lights, rear hydraulic options, stop lights
19	7.5 A	Slow travel speed
20	15 A	Front wiper
21	7.5 A	Transmission control box supply
22	7.5 A	Engine cutoff
23	7.5 A	Joystick supply
24	7.5 A	Direction indicators
25	10 A	Steering mode control
26	20 A	Heating fan
27	7.5 A	Direction of travel
28	7.5 A	Instrument panel supply
29	10 A	Reversing light and roof windscreen wiper (option)
30	7.5 A	Rear windscreen wiper: Rear windscreen and roof washer
31	10 A	Boom angle measurement
32	7.5 A	Fan direction reversing (option) and side offset correction
01	20 A	Air conditioning fan (option)

REFERENCE	GAUGE	FUNCTION PROTECTED
02	7.5 A	Air conditioning compressor (option)
F01	50 A	Permanent line (+)
F02	40 A	Permanent line (+) by contact key
F03	70 A	Glow plugs

### Relays

REFERENCE	FUNCTION PERFORMED
1	Front work lights
2	Rear work lights
3	Road horn
4	Not used
5	Hydraulic function on boom
6	Headlamps
7	Full-beam
8	Advance safety if parking brake tight
9	Starting safety if transmission is in gear
10	Not used
11	Slow travel speed
12	Second hydraulic function on boom
13	Backup lights / backup alarm
14	Not used
15	Prevent raising of the stabilisers
16	Stabilisers
17	Raise left stabiliser
18	Raise right stabiliser
19	Radio control for acceleration of the engine
20	Not used
21	Not used
E01	Glowplugs
E02	Starter control
E15	12V power relay after contact
E16	Air conditioning compressor (option)
E17	Air conditioning fan (option)
E18	Center for the directional signals (located beneath the fuse box)

## BATTERY

### Removal And Installation

# WARNING

Batteries contain acid which burns eyes and skin on contact. Wear goggles, protective clothing and rubber gloves to keep acid off body.

In case of acid contact, wash immediately with water. In case of eye contact get prompt medical attention and wash eye with clean, cool water for at least 15 minutes.

If electrolyte is taken internally drink large quantities of water or milk! DO NOT induce vomiting. Get prompt medical attention.

W-2065-1296

Figure 60-20-1

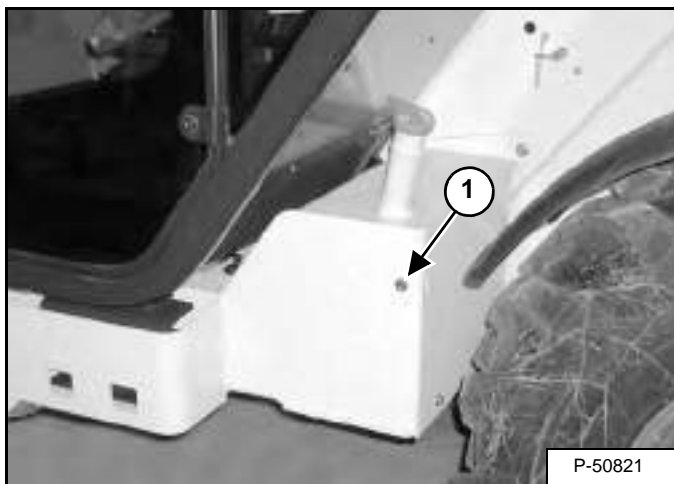

Remove the battery access door (Item 1) [Figure 60-20-1].

Figure 60-20-2

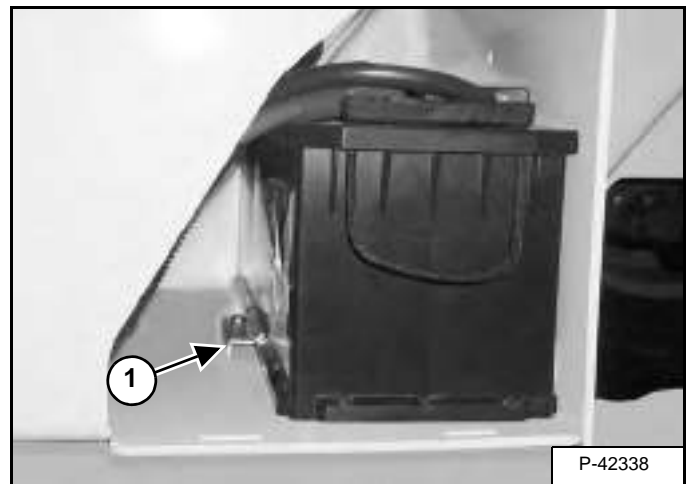

Remove the battery hold down clamp (Item 1) [Figure 60-20-2].

Figure 60-20-3

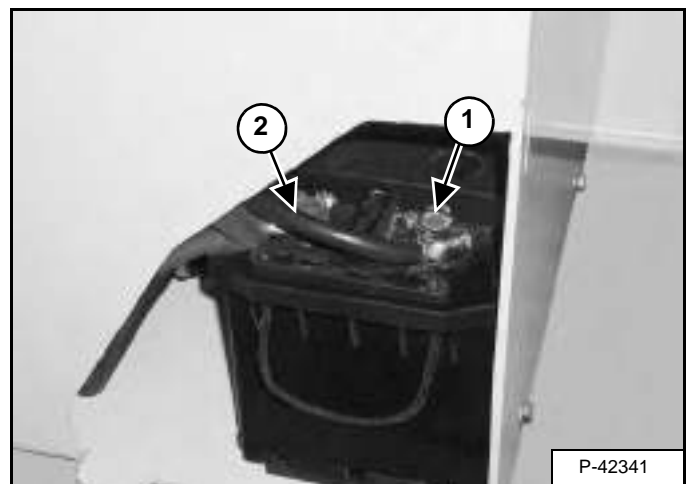

Always disconnect the negative cable (Item 1) [Figure 60-20-3] first to prevent sparks.

Remove the positive battery cable (Item 2) [Figure 60-20-3].

Remove the battery.

## BATTERY (CONT'D)

### Servicing

Figure 60-20-4

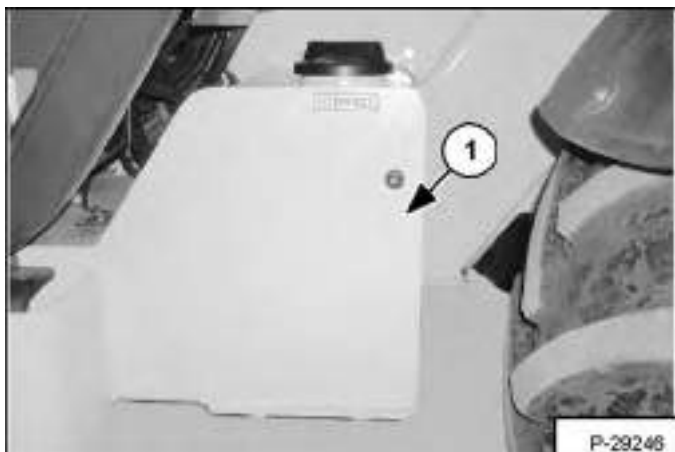

Figure 60-20-5



Always clean the terminals and cable ends when installing a new battery [Figure 60-20-4] & [Figure 60-20-5].

When installing the battery in the machine, do not touch any metal parts with the battery terminal posts.

Connect and tighten the battery cables. Connect the negative (-) cable last to prevent sparks.

## **WARNING**

Batteries contain acid which burns eyes and skin on contact. Wear goggles, protective clothing and rubber gloves to keep acid off body.

In case of acid contact, wash immediately with water. In case of eye contact get prompt medical attention and wash eye with clean, cool water for at least 15 minutes.

If electrolyte is taken internally drink large quantities of water or milk! DO NOT induce vomiting. Get prompt medical attention.

W-2065-1296

Figure 60-20-6



The battery cables must be clean and the connections tight. Remove acid or corrosion from the battery and cables with a sodium bicarbonate (baking soda) and water solution [Figure 60-20-6].

Check the electrolyte level in the battery. Add distilled water as needed.

Put Battery Saver (P/N 6664458) or grease on the battery terminals and cable ends to prevent corrosion.

## BATTERY (CONT'D)

### Using A Booster Battery (Jump Starting)

If it is necessary to use a booster battery to start the engine, BE CAREFUL! There must be one person in the operator's seat and one person to connect and disconnect the battery cables. (Booster Cables)

The key switch must be OFF. The booster battery must be 12 volt.

Figure 60-20-7

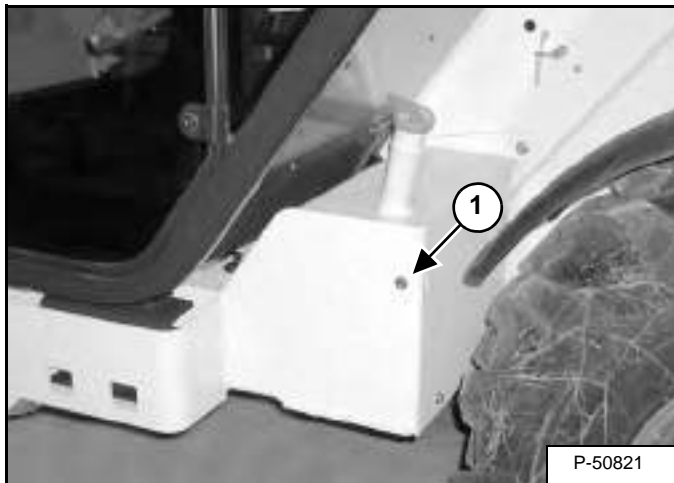

Remove the battery access door (Item 1) [Figure 60-20-7].

**NOTE:** The battery compartment is located in front of the left rear tire, on the back side of the cab.

## WARNING

Keep arcs, sparks flames and lighted tobacco away from batteries. When *jumping* from booster battery make final connection (negative) at machine frame.

Do not jump start or charge a frozen or damaged battery. Warm battery to 60°F (16°C) before connecting to a charger. Unplug charger before connecting or disconnecting cables to battery. Never lean over battery while boosting, testing or charging.

Battery gas can explode and cause serious injury.

W-2066-0705

## WARNING

When the steering frame lock is in locked position, the machine cannot be steered. Disengage the lock before operating, or you will not be able to steer the machine.

W-2023-0388

Figure 60-20-8

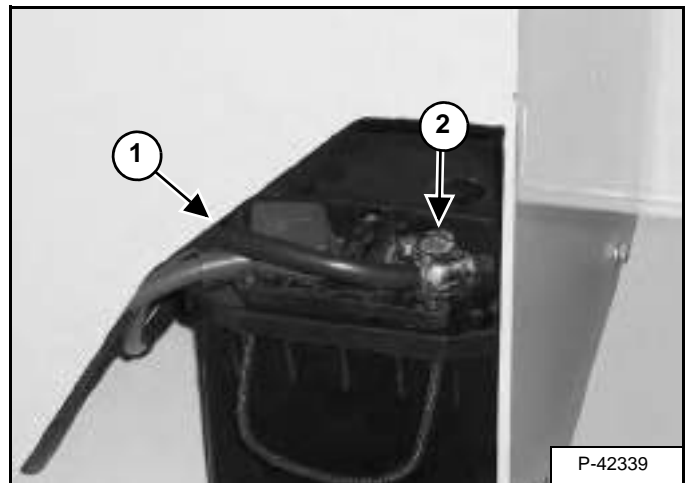

Connect the end of the first cable to the positive (+) terminal of the booster battery. Connect the other end of the same cable to the positive terminal (Item 1) [Figure 60-20-8] on the Telescopic Handler battery.

Connect the end of the second cable to the negative (-) terminal of the booster battery. Connect the other end of the same cable to the negative terminal (Item 2) [Figure 60-20-8] on the Telescopic Handler battery.

Keep cables away from moving parts. Start the engine.

After the engine has started, remove the ground (-) cable (Item 2) [Figure 60-20-8] first.

Remove the cable from the positive terminal (Item 1) [Figure 60-20-8].



**Bobcat®**

## ALTERNATOR

### Removal And Installation

Figure 60-30-1

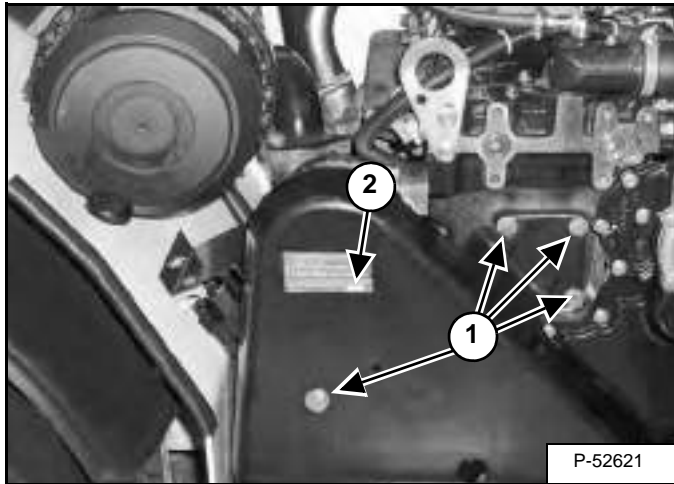

Open the engine cover.

Remove the four bolts (Item 1) and belt shield (Item 2) [Figure 60-30-1].

Figure 60-30-2

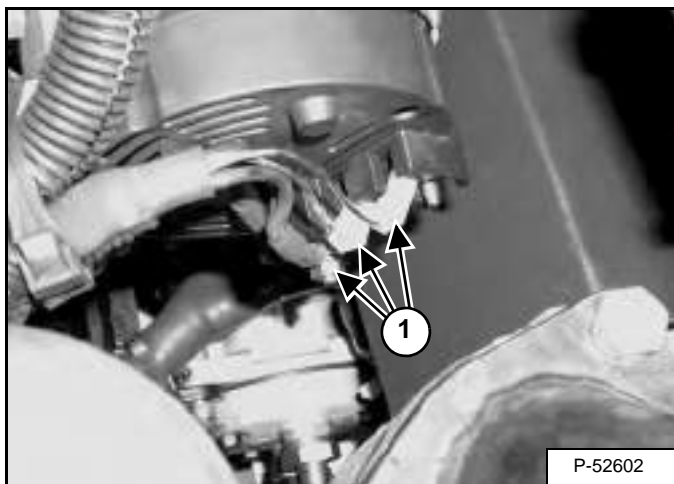

Remove the three connectors (Item 1) [Figure 60-30-2] from the back of the alternator.

Figure 60-30-3

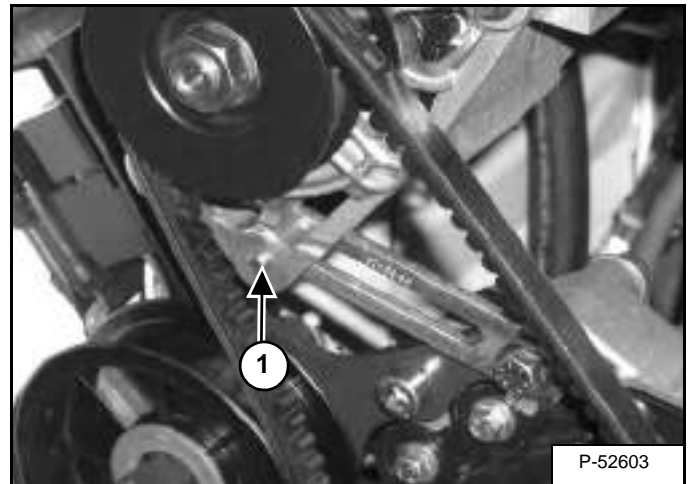

Loosen and remove the alternator adjusting bolt (Item 1) [Figure 60-30-3].

Figure 60-30-4

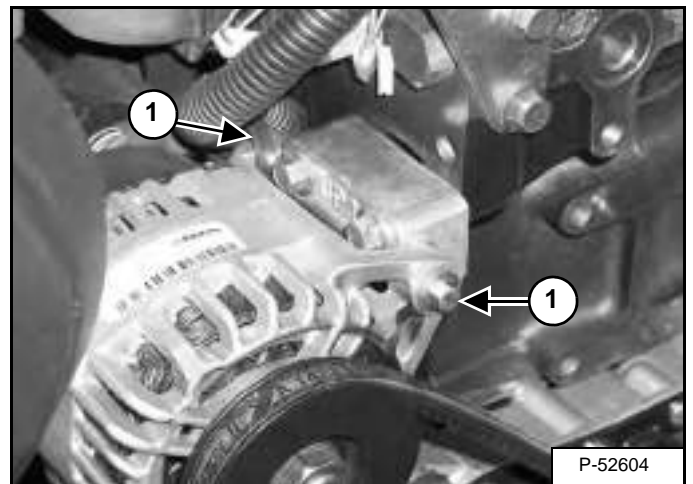

Loosen and remove both mounting bolts (Item 1) [Figure 60-30-4].

Remove the alternator.

## ALTERNATOR (CONT'D)

### Adjusting The Alternator Belt

Stop the engine.

Open the engine cover.

**Figure 60-30-5**

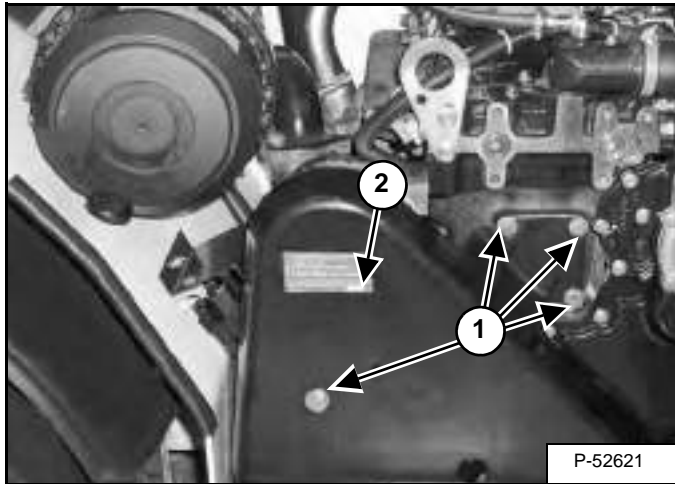

Remove the two bolts (Item 1) and the belt shield (Item 2) [Figure 60-30-5].

**Figure 60-30-6**

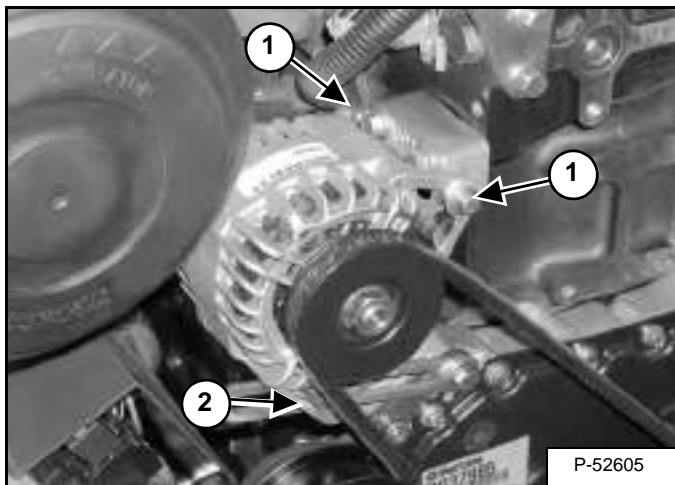

Loosen the two alternator mounting bolts (Item 1) [Figure 60-30-6].

Loosen the adjustment bolt (Item 2) [Figure 60-30-6].

**Figure 60-30-7**

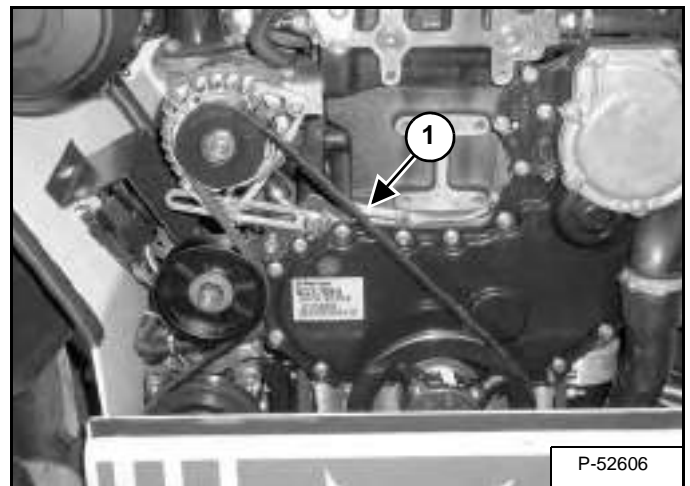

Move the alternator until the belt has 5/16 inch (8,0 mm) movement at the middle of the belt span (Item 1) [Figure 60-30-7] with 15 lb. (20 N•m) of force.

Tighten the adjustment and mounting bolts.

Install the belt shield.

Close the engine cover



## STARTER

### Removal And Installation

Figure 60-40-1

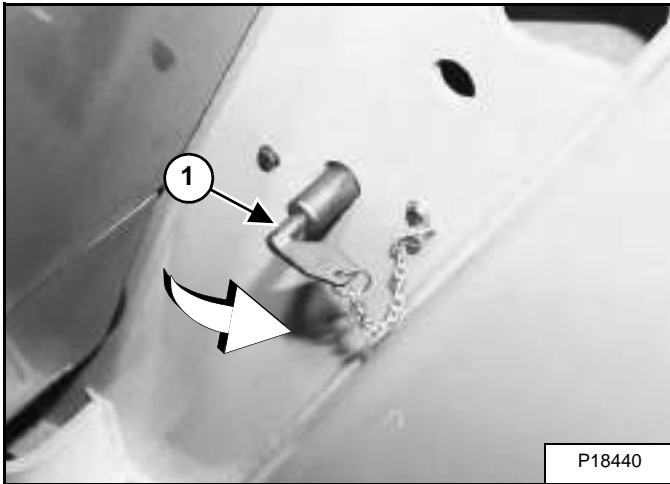

Rotate the battery disconnect switch (Item 1) [Figure 60-40-1] to the right, to disconnect the power supply from the battery.

Figure 60-40-2

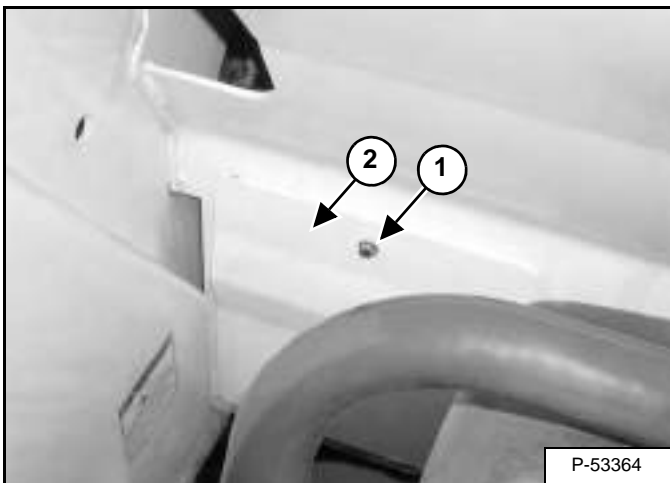

Remove the access cover mounting bolt (Item 1) and remove the access cover (Item 2) [Figure 60-40-2].

Figure 60-40-3

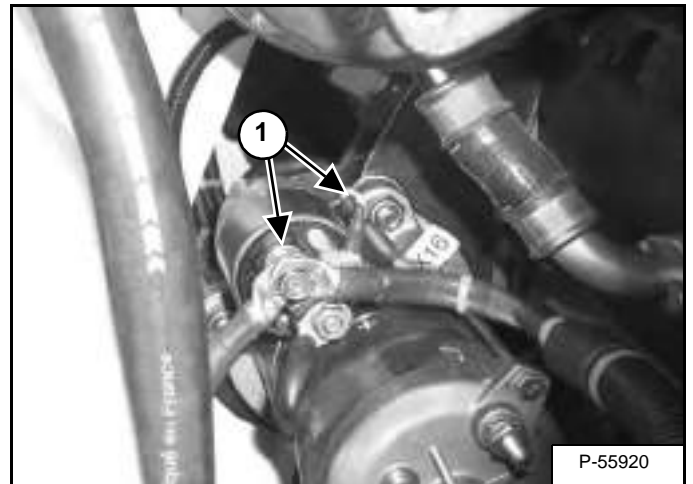

Remove the three wires (Item 1) [Figure 60-40-3] from the starter.

Figure 60-40-4

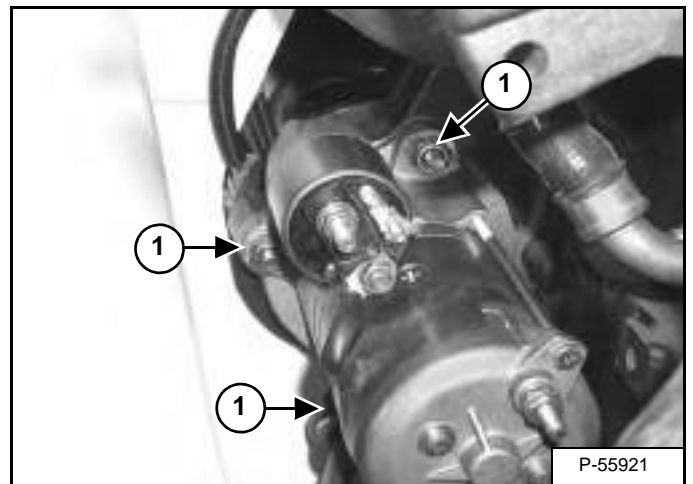

Remove the three nuts and bolts (Item 1) [Figure 60-40-4] and remove the starter.

Installation: Tighten to 40-45 ft.-lb. (54-61 N•m) torque.

---

## **STARTER (CONT'D)**

### **Assembly / disassembly**

The starter is not serviceable. If the starter is defective please contact your dealer to order a complete starter.

## LIGHTS

### Rear Light Removal And Installation

Figure 60-60-1



Remove the rear cover (Item 1) [Figure 60-60-1].

Figure 60-60-2

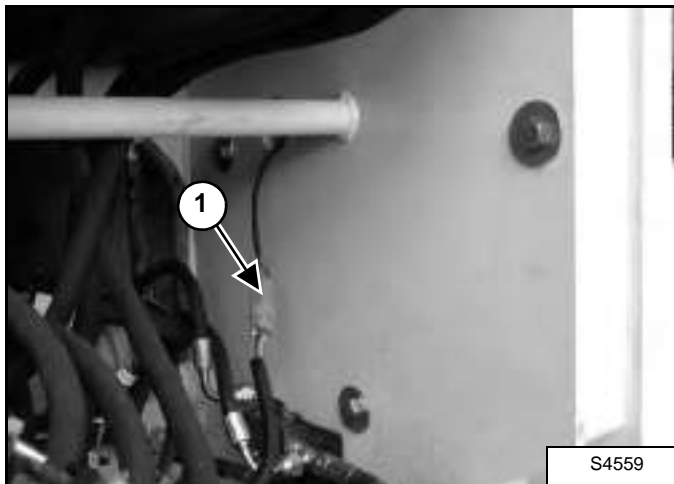

Unplug the light harness connector (Item 1) [Figure 60-60-2] from the main harness.

Figure 60-60-3

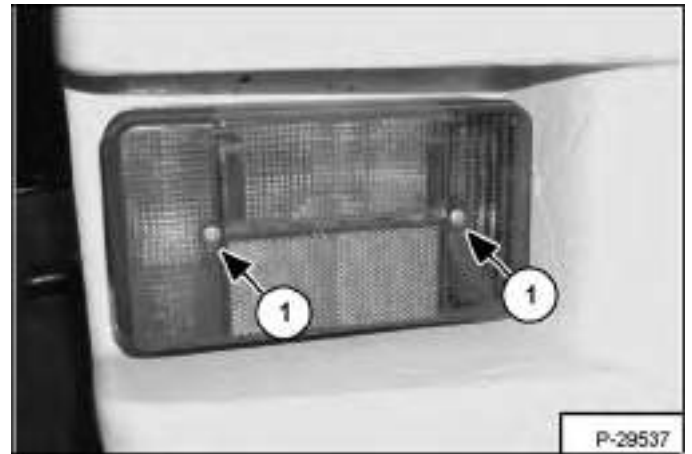

Remove the two lens retainer screws (Item 1) [Figure 60-60-3].

Figure 60-60-4

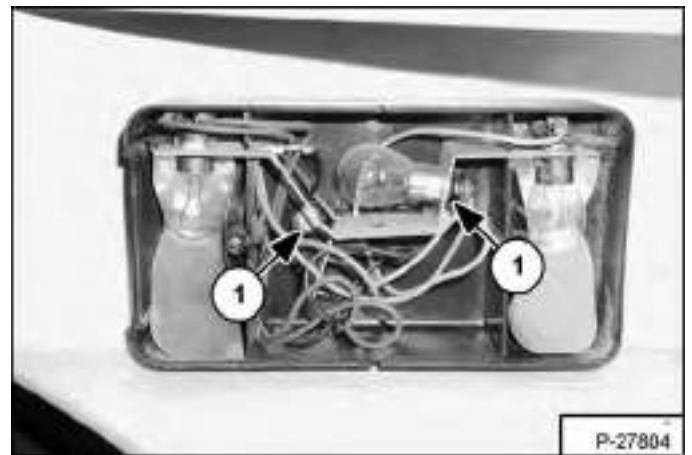

Remove the two light mounting bolts (Item 1) [Figure 60-60-4].

Remove the light assembly.

## LIGHTS (CONT'D)

### Front Light Removal And Installation

Figure 60-60-5

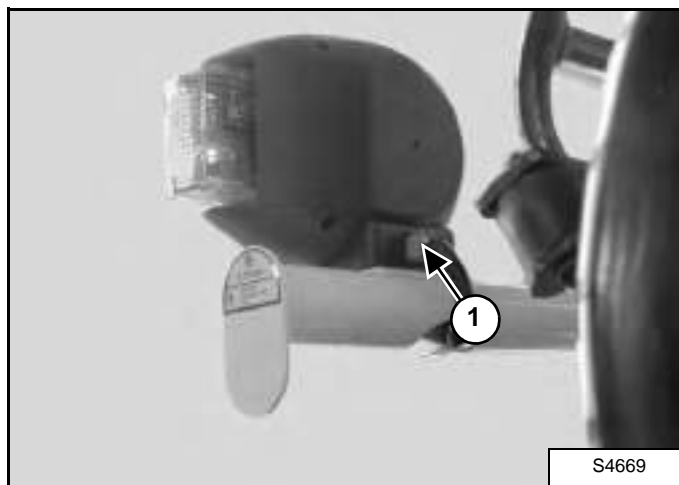

Unplug the harness (Item 1) [Figure 60-60-5] from the light.

Figure 60-60-6

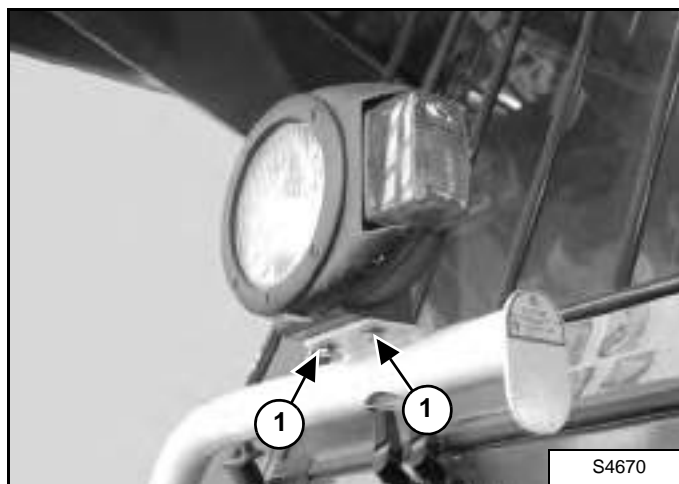

Remove the two bolts (Item 1) [Figure 60-60-6] and remove the light.

## TRAVEL / SIGNAL LEVER

### Removal And Installation

Remove the instrument panel (See "Removal And Installation" on page 60-80-1).

Figure 60-70-1

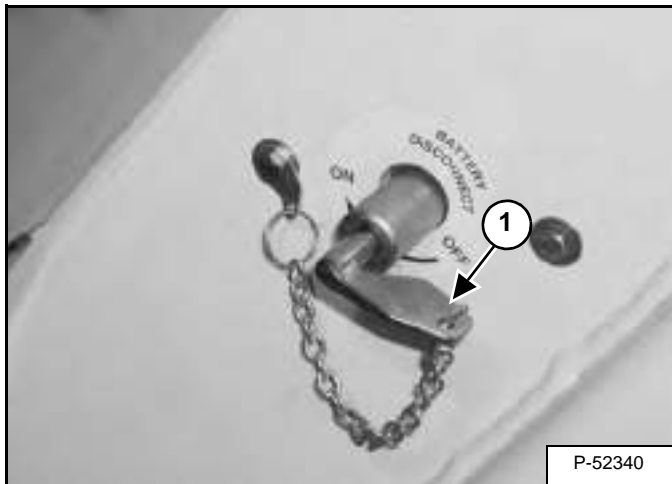

Rotate the battery disconnect switch (Item 1) [Figure 60-70-1] to the right, to disconnect the power supply from the battery.

Figure 60-70-2

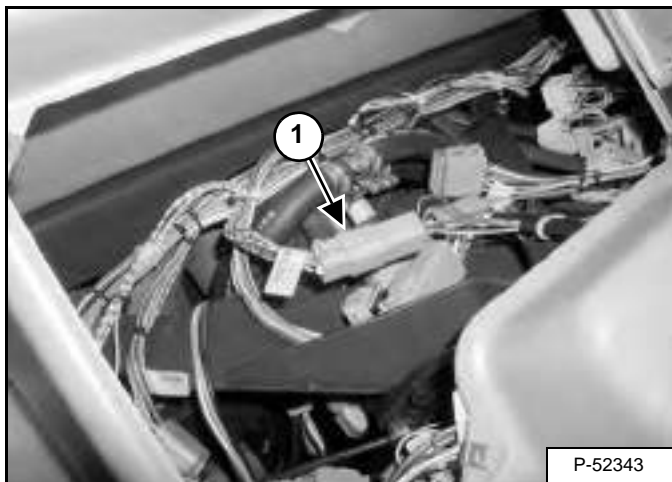

Disconnect the travel control wire harness connector (Item 1) [Figure 60-70-2].

Figure 60-70-3

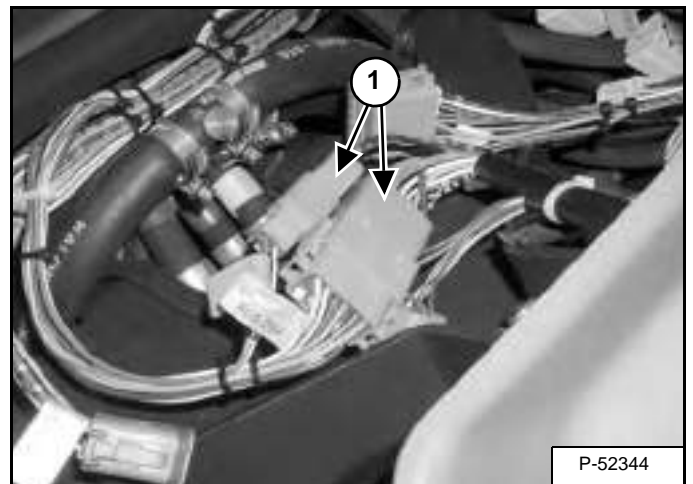

Disconnect the two signal control wire connectors (Item 1) [Figure 60-70-3].

Figure 60-70-4

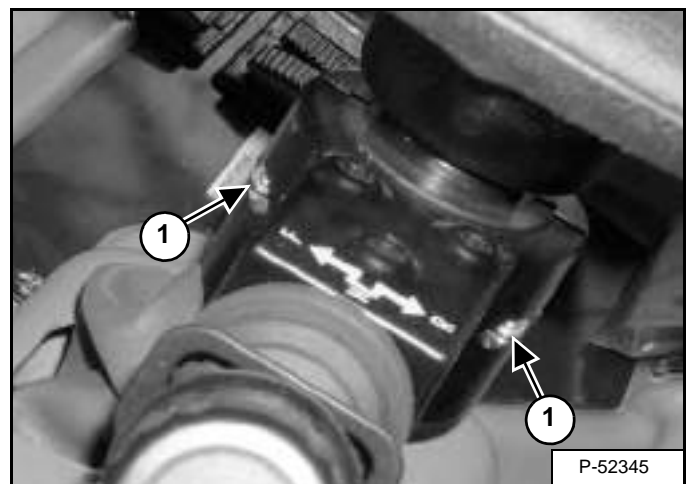

Remove the two screws (Item 1) [Figure 60-70-4] from the travel / signal levers.

## TRAVEL / SIGNAL LEVER (CONT'D)

### Removal And Installation (Cont'd)

Figure 60-70-5

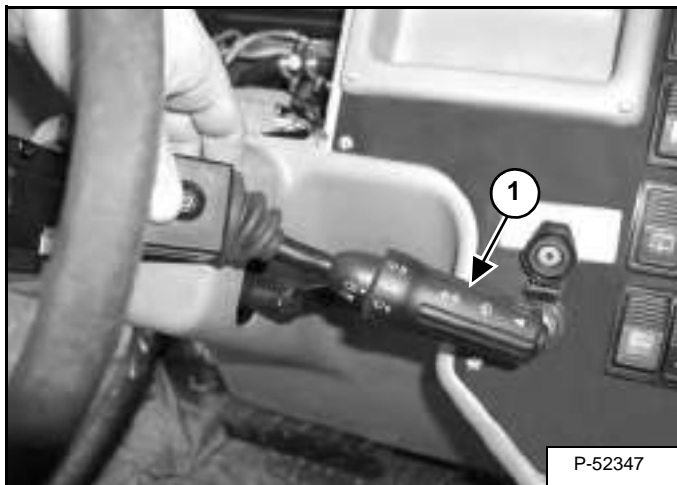

Remove the signal lever (Item 1) [Figure 60-70-5].

Figure 60-70-6

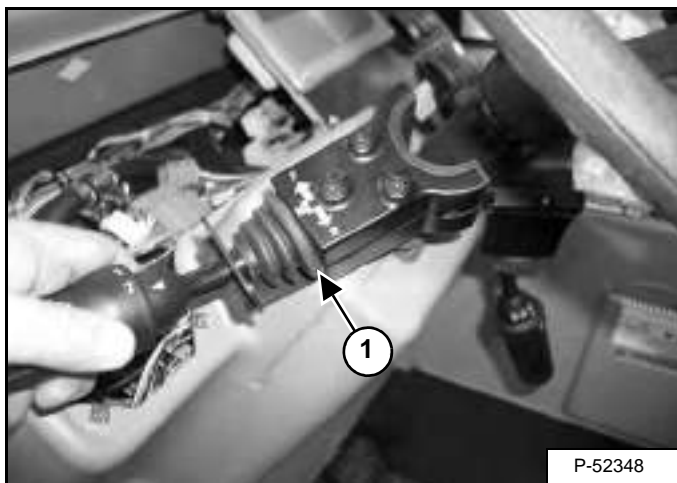

Remove the travel lever (Item 1) [Figure 60-70-6].

Figure 60-70-7

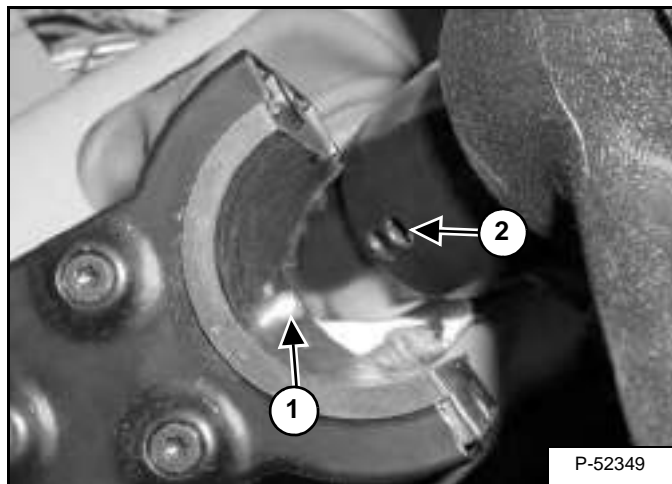

Installation: Align the pin (Item 1) in the travel lever with the top hole (Item 2) [Figure 60-70-7] in the steering column.

## INSTRUMENT PANEL

### Removal And Installation

Figure 60-80-1



Remove the temperature control knob (Item 1) [Figure 60-80-1]. (If Equipped)

Figure 60-80-2



Remove the nut (Item 1) [Figure 60-80-2] letting the temperature controller fall inward.

Figure 60-80-3

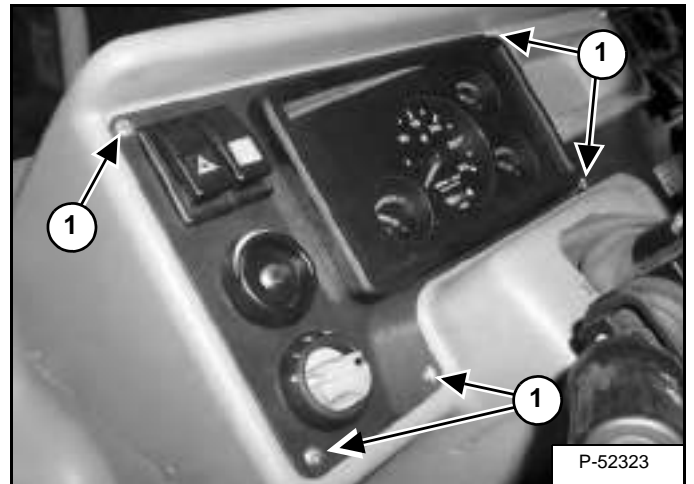

Remove the five instrument panel mounting bolts (Item 1) [Figure 60-80-3].

Figure 60-80-4

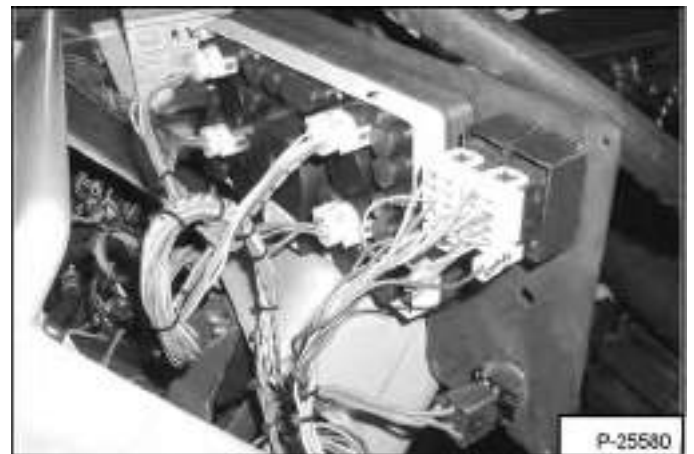

Tilt the instrument panel forward and unplug all connectors [Figure 60-80-4]. Remove the instrument panel.

**NOTE: Mark the connectors for correct installation.**



**Bobcat®**



## SWITCH PANEL

### Removal And Installation

Figure 60-90-1

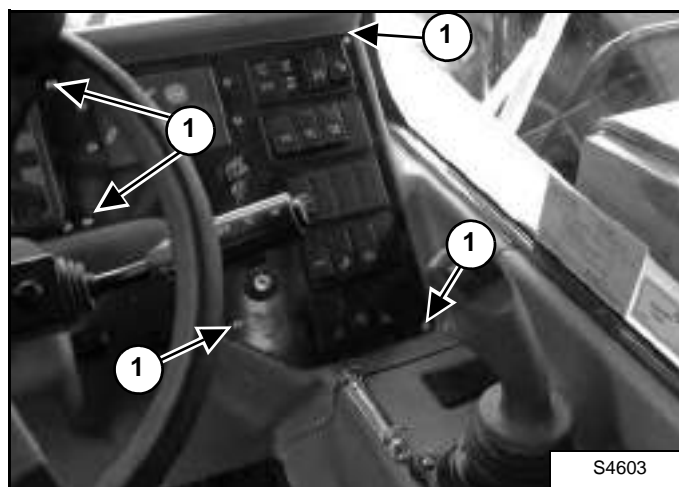

Remove the five screws (Item 1) [Figure 60-90-1].

Figure 60-90-2



Unplug the harness connectors from the back of the switch panel [Figure 60-90-2].

**NOTE:** Mark all connectors for ease of installation.

Remove the switch panel.



**Bobcat®**

## BRAKE LIGHT SWITCH

### Removal And Installation

Figure 60-100-1

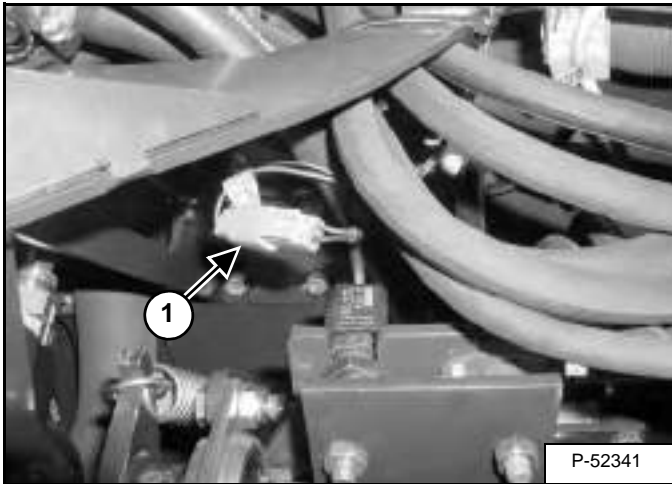

Remove the dash cover / column cover (See "Removal And Installation" on page 50-130-1).

Unplug the switch connector (Item 1) [Figure 60-100-1] from the wiring harness.

Figure 60-100-2

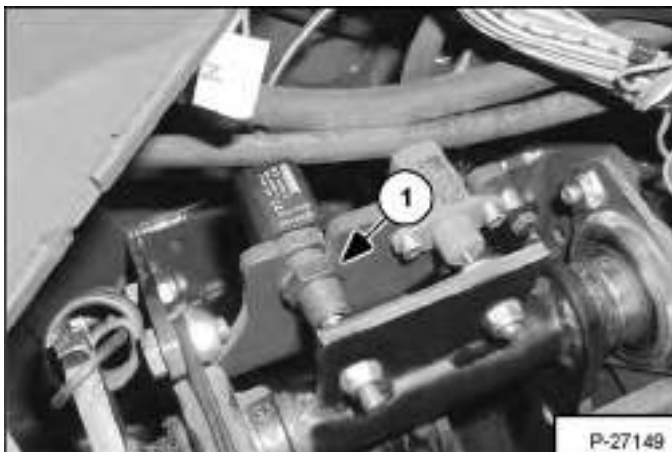

Loosen the nut (Item 1) [Figure 60-100-2].  
Remove the switch.

### Adjustment

Figure 60-100-3

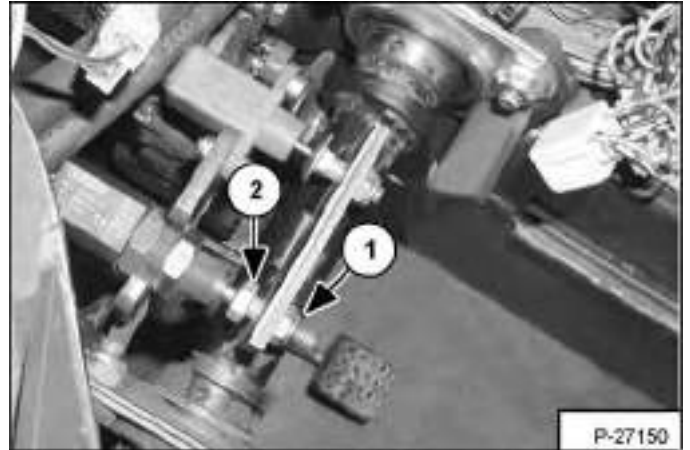

Remove the dash cover / column cover (See "Removal And Installation" on page 50-130-1).

Loosen the nut (Item 1) [Figure 60-100-3].

With the brake pedal at rest, turn the adjustment bolt (Item 2) [Figure 60-100-3] until it touches the brake light switch plug.

Tighten the nut (Item 1) [Figure 60-100-3].



**Bobcat®**

## FRONT WIPER MOTOR

### Removal And Installation

Figure 60-110-1

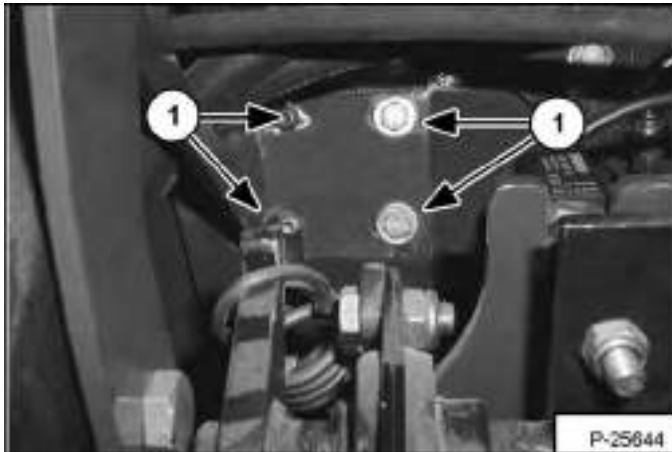

Remove the dash cover / steering column cover (See "Removal And Installation" on page 50-130-1).

Remove the four lower mounting bracket bolts (Item 1) [Figure 60-110-1].

Figure 60-110-2

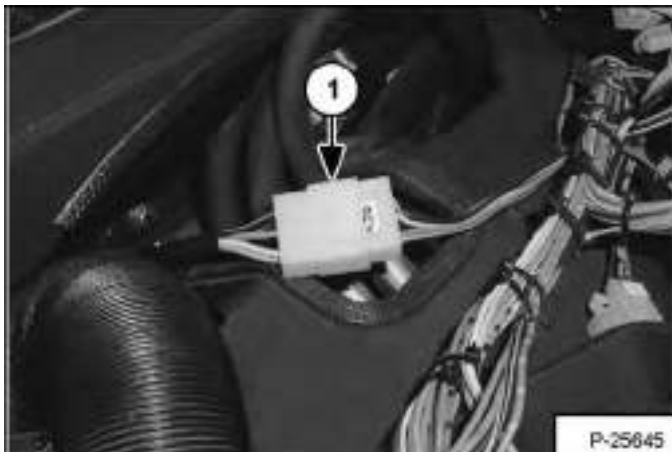

Disconnect the front wiper connector (Item 1) [Figure 60-110-2] from the main harness.

Reposition the main wire harness to the right side of the cab.

Figure 60-110-3



Remove the two mounting bracket bolts (Item 1) [Figure 60-110-3].

Figure 60-110-4



Reposition the steering column assembly (as shown) [Figure 60-110-4].

## FRONT WIPER MOTOR (CONT'D)

### Removal and Installation (Cont'd)

Figure 60-110-5

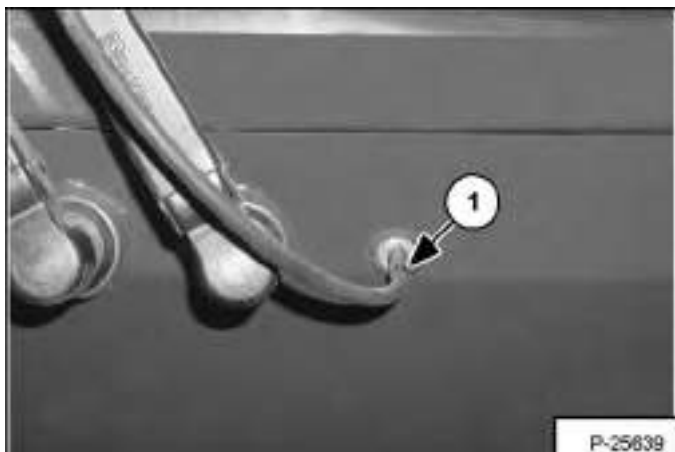

Remove the spray tube (Item 1) [Figure 60-110-5].

Figure 60-110-6

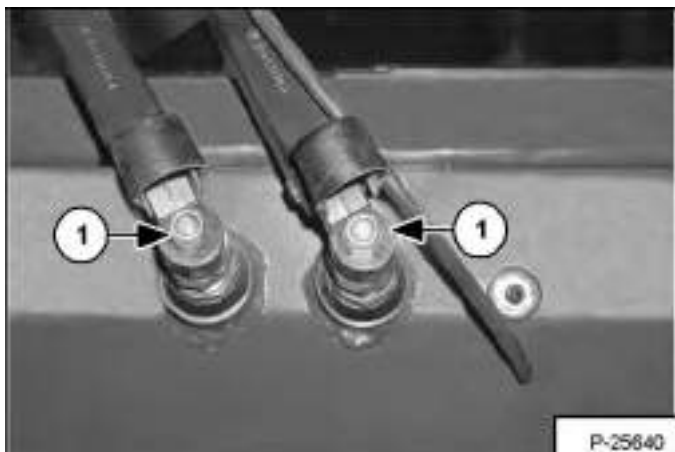

Flip the wiper covers and remove the two nuts (Item 1) [Figure 60-110-6].

Figure 60-110-7



Remove the wiper arms from the wiper motor shafts [Figure 60-110-7].

Figure 60-110-8

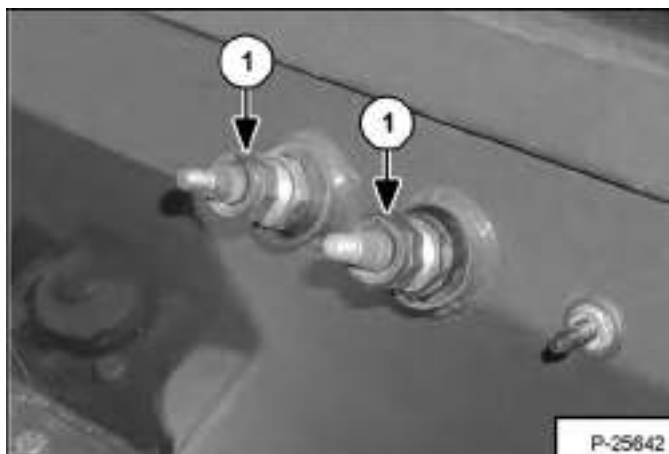

Remove both outer nuts (Item 1) [Figure 60-110-8].

## FRONT WIPER MOTOR (CONT'D)

### Removal And Installation (Cont'd)

Figure 60-110-9

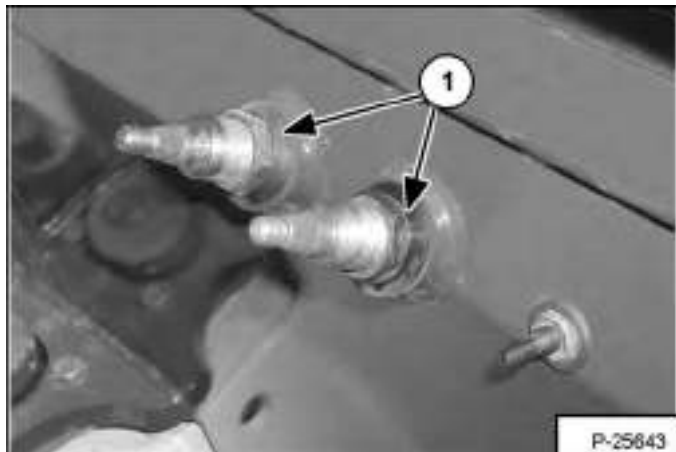

Remove both inner nuts and washers (Item 1) [Figure 60-110-9].

Figure 60-110-10



Remove the wiper motor from inside the cab [Figure 60-110-10].



**Bobcat®**



## TOP WIPER MOTOR

### Removal And Installation

Figure 60-120-1

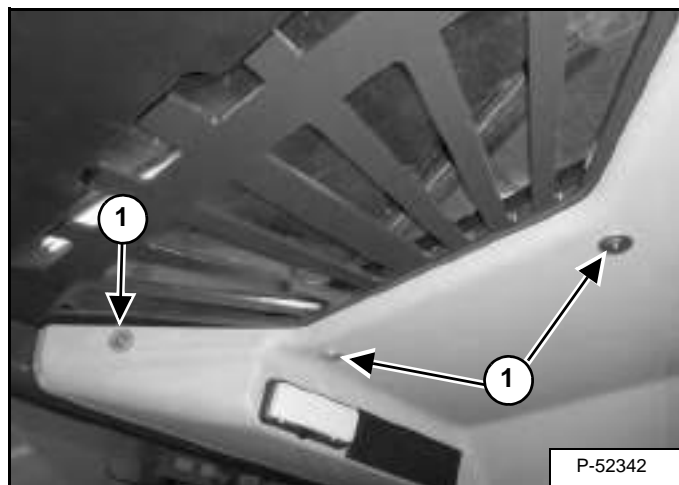

Remove the three screws (Item 1) [Figure 60-120-1] from the upper panel.

Figure 60-120-2



Slide the upper panel forward on the support rails [Figure 60-120-2].

Lower the panel.

Figure 60-120-3

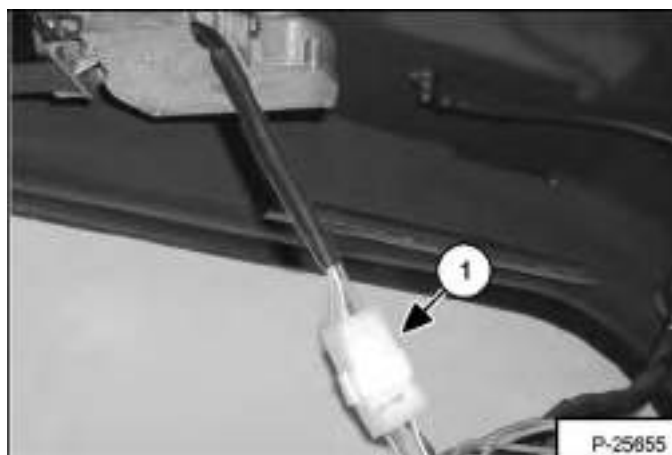

Unplug the wiper motor connector (Item 1) [Figure 60-120-3] from the harness.

Figure 60-120-4



Remove the squirter tube (Item 1) [Figure 60-120-4].

## TOP WIPER MOTOR (CONT'D)

### Removal And Installation (Cont'd)

Figure 60-120-5

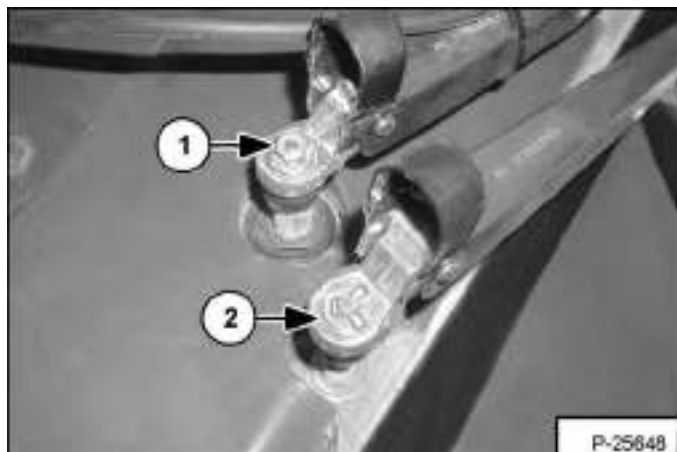

Flip open the wiper covers and remove the nut (Item 1) and clip (Item 2) [Figure 60-120-5].

Figure 60-120-6



Remove the wiper arms from the wiper shafts [Figure 60-120-6].

Figure 60-120-7



Remove the plastic nut (Item 1) and extension post (Item 2) [Figure 60-120-7].

Figure 60-120-8

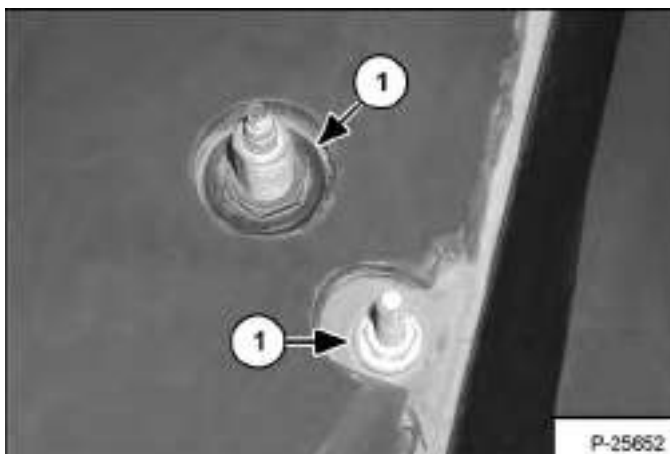

While supporting the wiper motor inside the cab, have an assistant remove the two nuts (Item 1) [Figure 60-120-8].

Remove the wiper motor.

## REAR WIPER MOTOR

### Removal And Installation

Figure 60-130-1

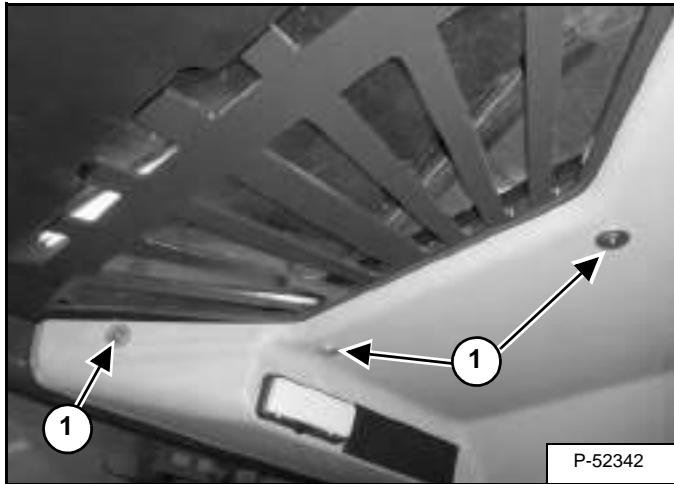

Remove the three screws (Item 1) [Figure 60-130-1] from the upper panel and slide the upper panel forward.

Figure 60-130-2

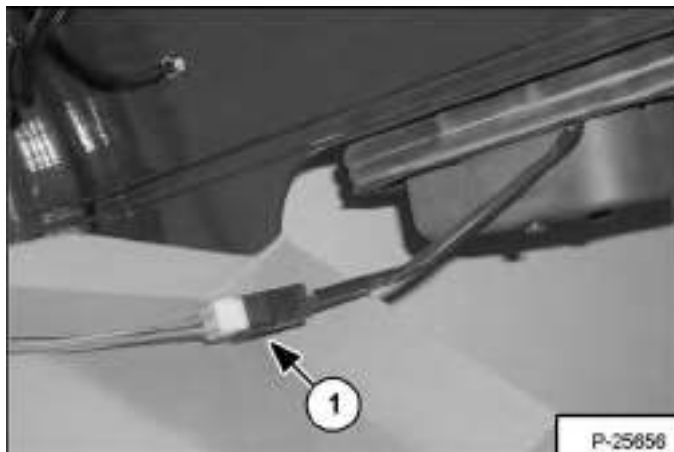

Unplug the rear wiper motor connector (Item 1) [Figure 60-130-2] from the harness.

Figure 60-130-3

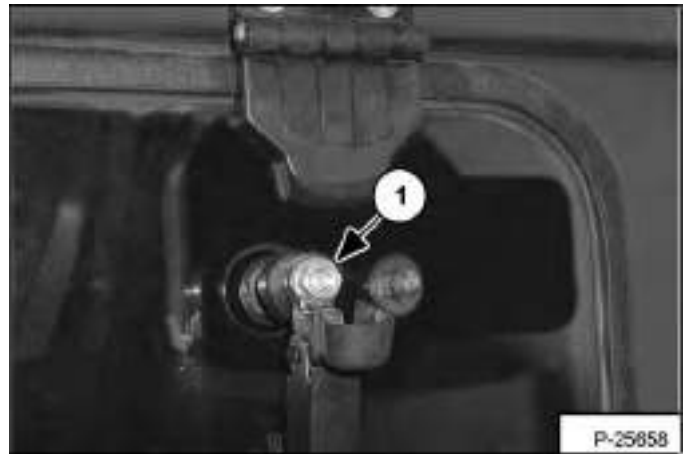

Flip open the wiper cover and remove the nut (Item 1) [Figure 60-130-3].

Figure 60-130-4



Remove the wiper arm [Figure 60-130-4].

## REAR WIPER MOTOR (CONT'D)

### Removal And Installation (Cont'd)

Figure 60-130-5



Have an assistant support the wiper motor [Figure 60-130-5].

Figure 60-130-6

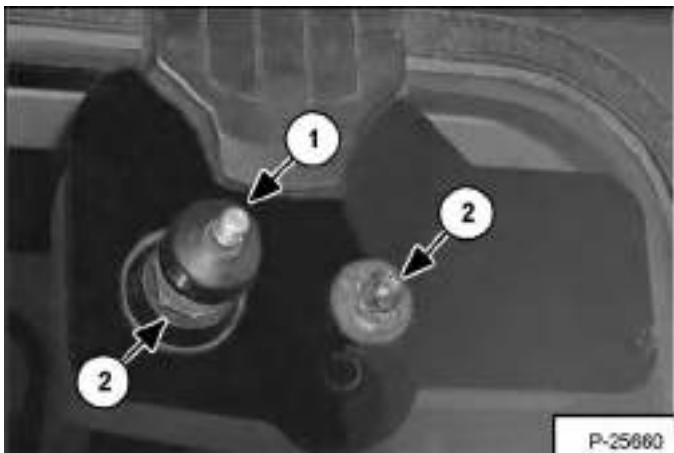

Remove the plastic cover (Item 1) and two nuts (Item 2) [Figure 60-130-6].

Remove the wiper motor.

## PEDAL ASSEMBLY

### Removal And Installation

Figure 60-140-1

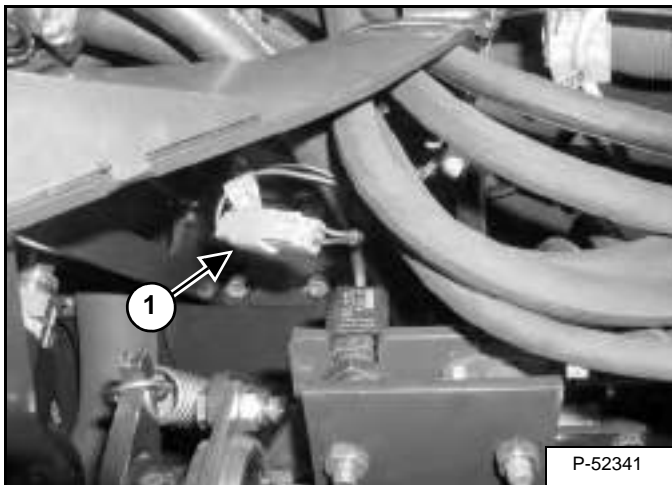

Remove the dash cover / column cover (See "Removal And Installation" on page 50-130-1).

Unplug the connector (Item 1) [Figure 60-140-1] from the brake light switch.

Figure 60-140-2

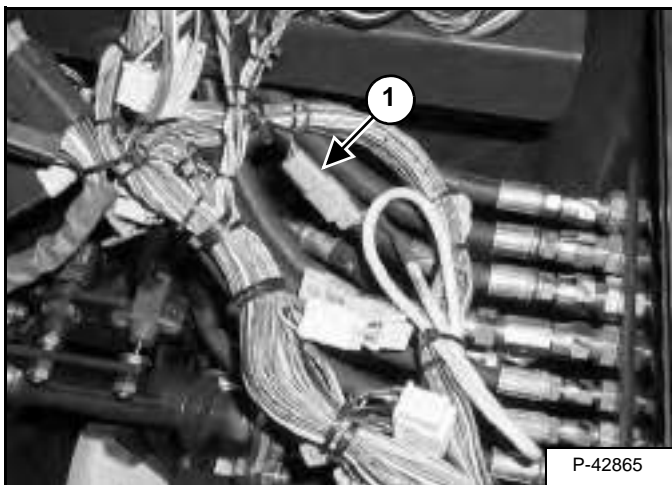

Unplug the connector (Item 1) [Figure 60-140-2] from the inching switch.

Figure 60-140-3

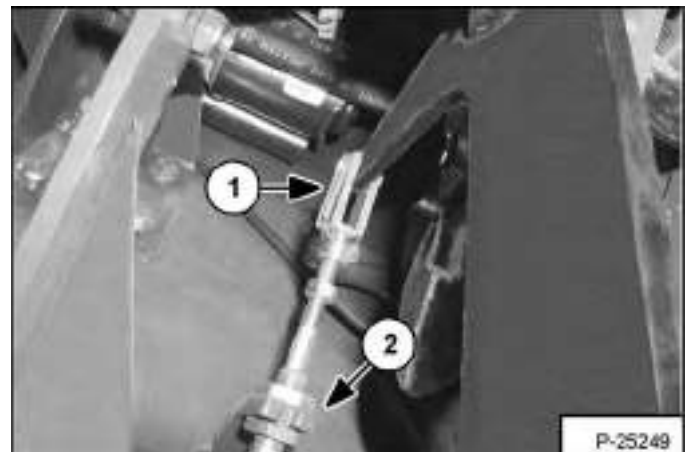

Remove the accelerator cable (Item 1) from the pedal and mounting bracket (Item 2) [Figure 60-140-3].

Figure 60-140-4

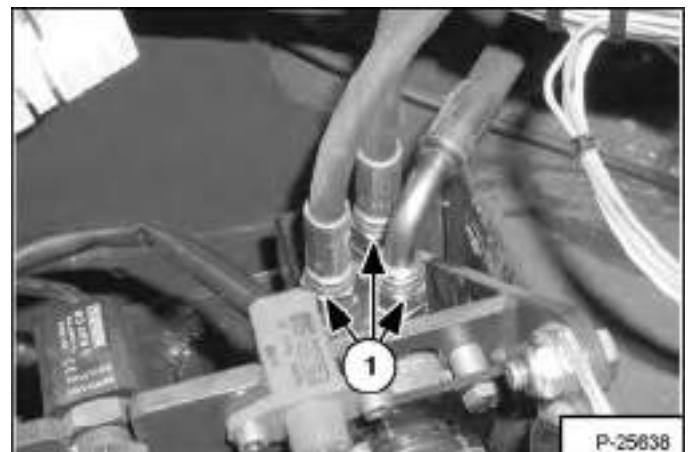

Remove the three hoses (Item 1) [Figure 60-140-4] from the brake valve.

**NOTE:** Mark hoses for correct installation.

## IMPORTANT

When repairing hydrostatic and hydraulic systems, clean the work area before disassembly and keep all parts clean. Always use caps and plugs on hoses, tubelines and ports to keep dirt out. Dirt can quickly damage the system.

I-2003-0888

## PEDAL ASSEMBLY (CONT'D)

### Removal and Installation (Cont'd)

Figure 60-140-5

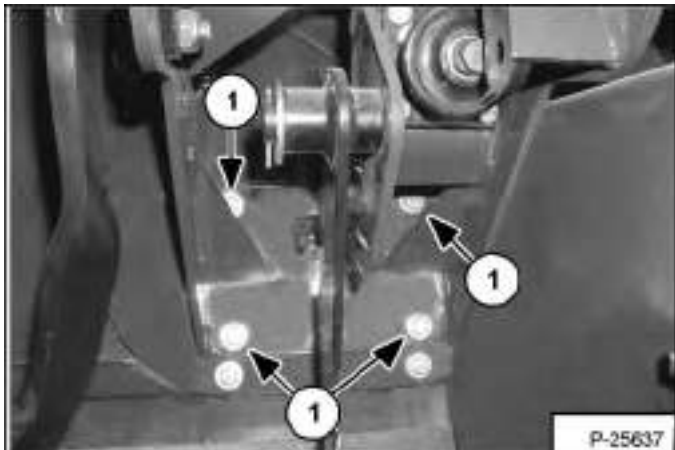

Remove the mounting bolts (Item 1) [Figure 60-140-5].

Remove the pedal assembly.

### Disassembly And Assembly

Figure 60-140-6

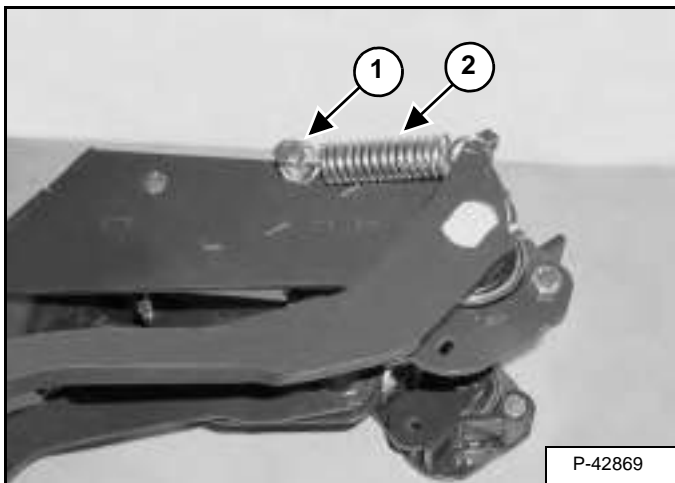

Remove the bolt (Item 1) and spring (Item 2) [Figure 60-140-6].

Figure 60-140-7

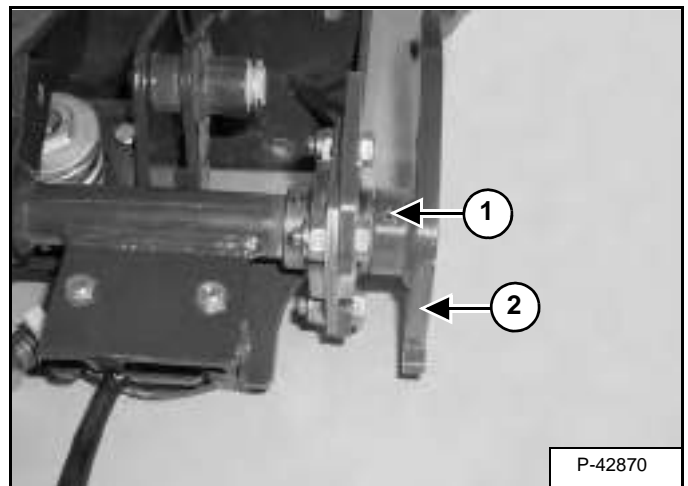

Remove the roll pin (Item 1) and pedal (Item 2) [Figure 60-140-7].

Figure 60-140-8

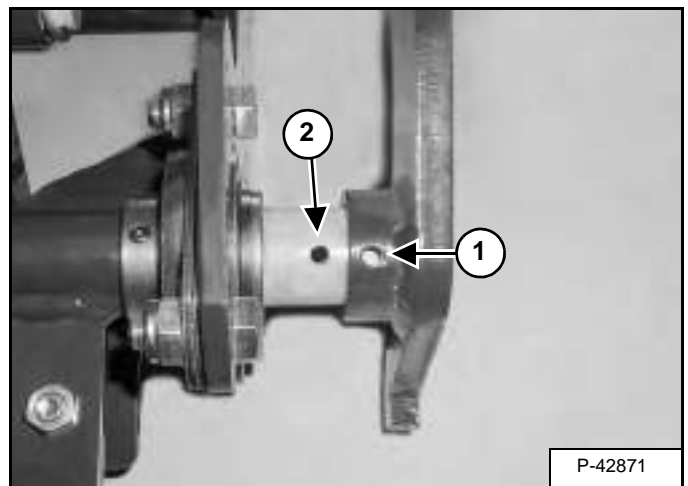

**Installation:** Align the hole (Item 1) in the pedal with the hole (Item 2) [Figure 60-140-8] in the shaft.

## PEDAL ASSEMBLY (CONT'D)

### Disassembly And Assembly (Cont'd)

Figure 60-140-9

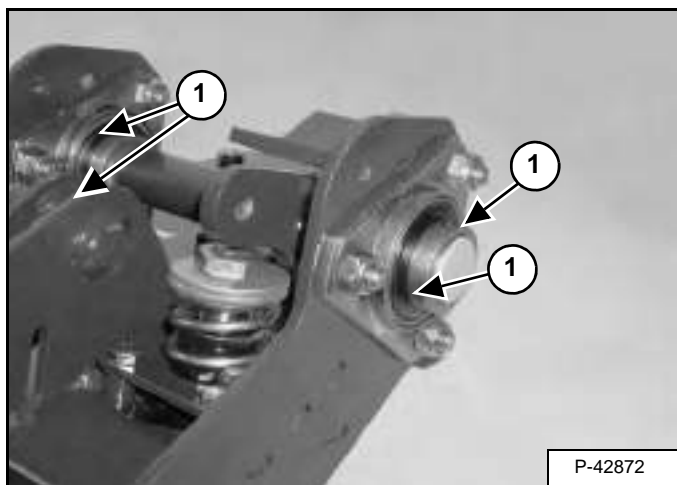

Loosen the two set screws (Item 1) [Figure 60-140-9] on the two bearings.

Figure 60-140-10

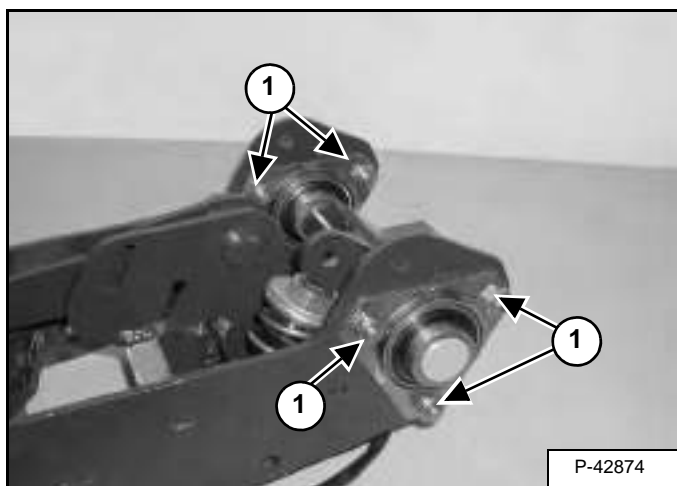

Remove the three bolts (Item 1) [Figure 60-140-10] from both bearing flanges.

Figure 60-140-11



Remove the shaft and bearing assembly [Figure 60-140-11].

Figure 60-140-12

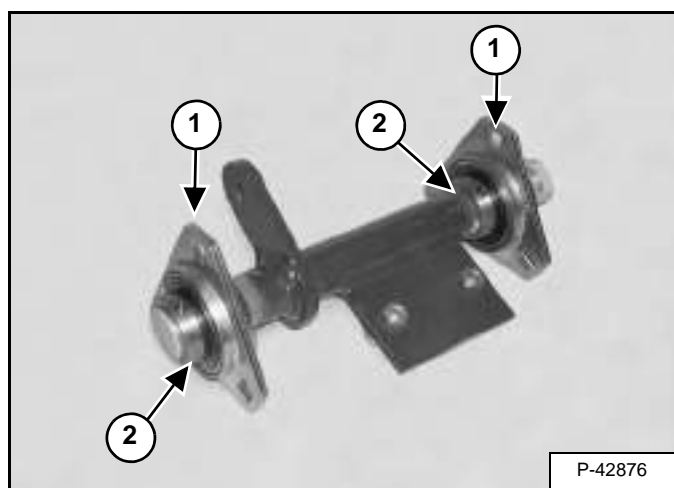

Remove the flanges (Item 1) and bearings (Item 2) [Figure 60-140-12].

## PEDAL ASSEMBLY (CONT'D)

### Disassembly And Assembly (Cont'd)

Figure 60-140-13

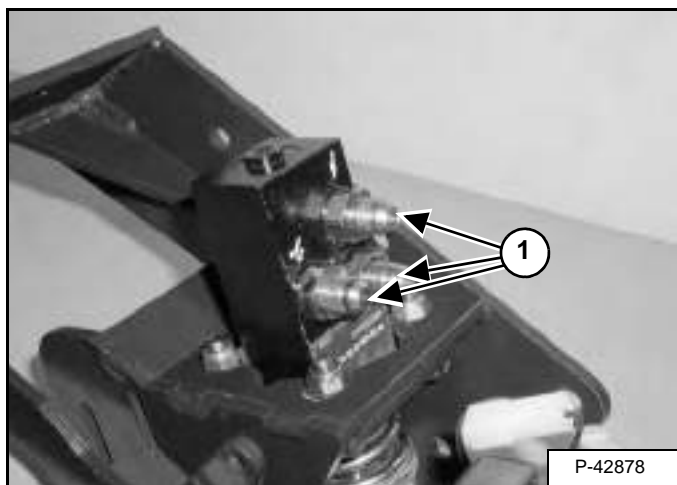

Remove the three fittings (Item 1) [Figure 60-140-13] from the brake valve.

Figure 60-140-14

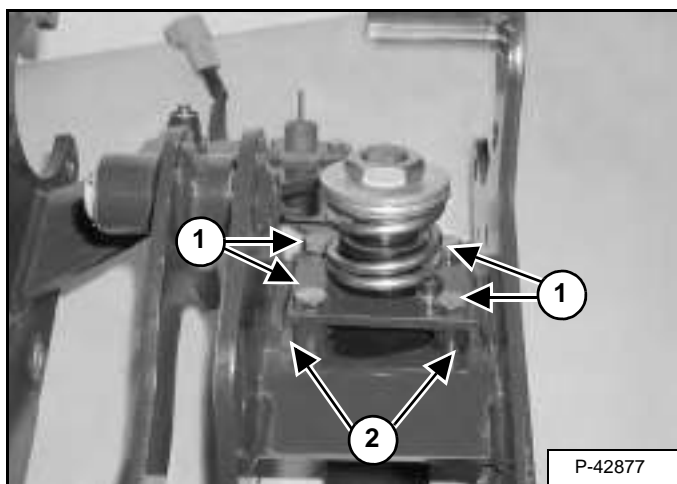

Remove the four bolts (Item 1) spacers (Item 2) [Figure 60-140-14] and nuts from the brake valve.

Figure 60-140-15

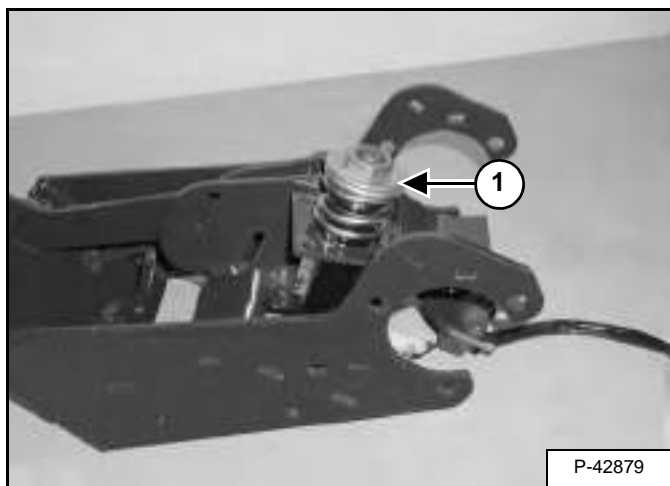

Remove the brake valve (Item 1) [Figure 60-140-15].

Figure 60-140-16

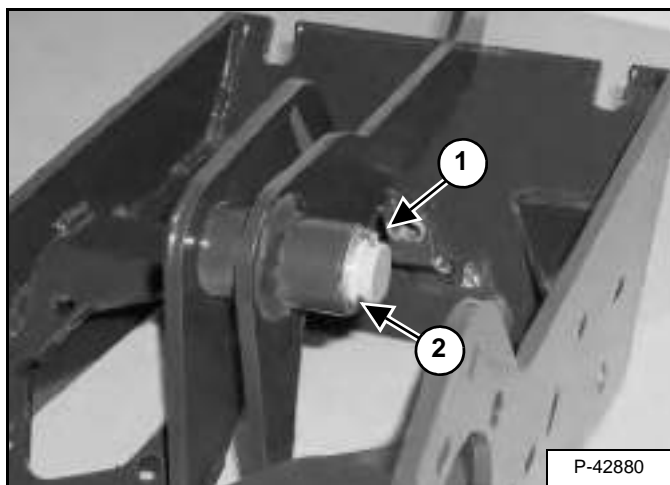

Remove the retainer pin (Item 1) and washer (Item 2) [Figure 60-140-16].



---

## PEDAL ASSEMBLY (CONT'D)

### Disassembly And Assembly (Cont'd)

Figure 60-140-17

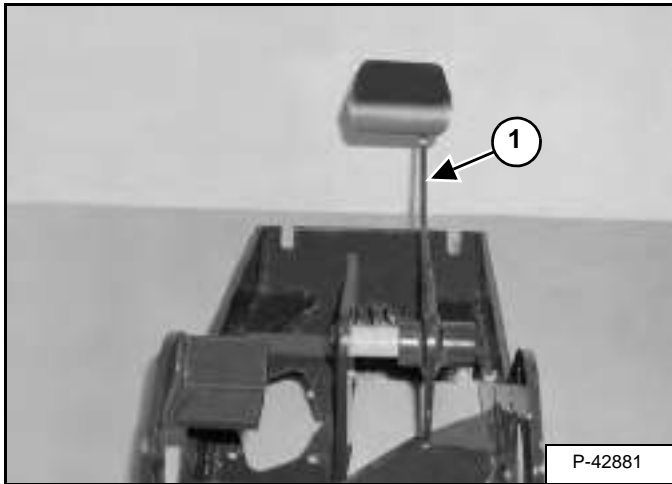

Remove the pedal (Item 1) [Figure 60-140-17].



## INCHING SWITCH

### Removal And Installation

Figure 60-150-1

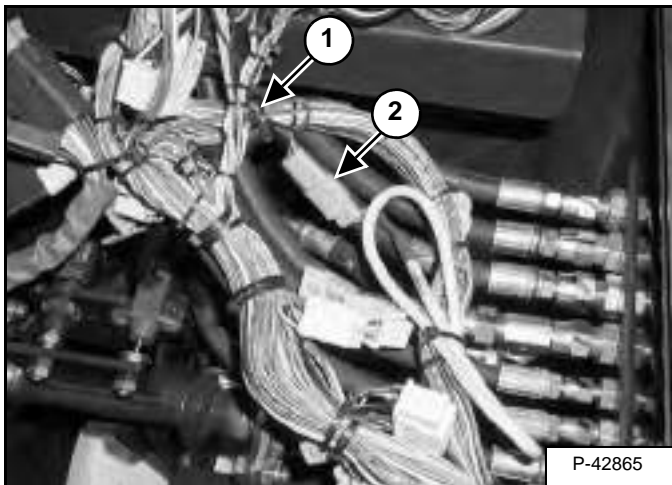

Remove the dash cover / column cover (See "Removal And Installation" on page 50-130-1).

Remove the tie strap (Item 1) and unplug the switch connector (Item 2) [Figure 60-150-1] from the harness.

Figure 60-150-2

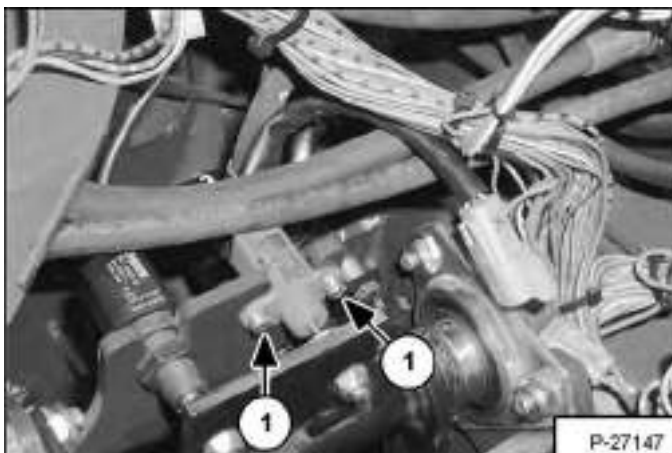

Remove the two mounting bolts and nuts (Item 1) [Figure 60-150-2].

**Installation:** Be sure the switch is on the front side of the mounting bracket.

Remove the switch.

## Adjustment

Figure 60-150-3

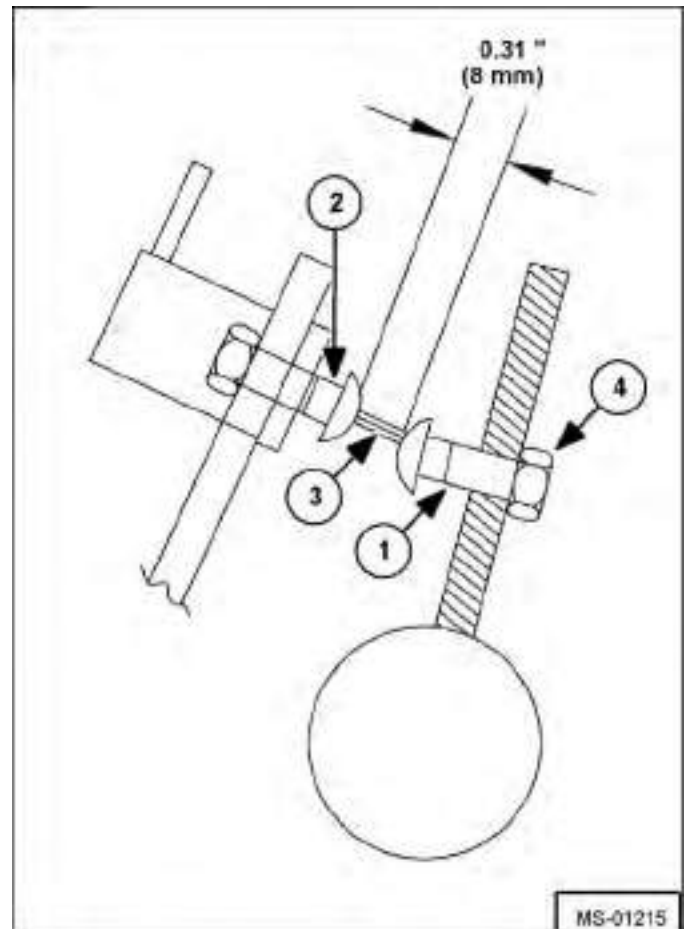

Remove the dash cover / column cover (See "Removal And Installation" on page 50-130-1).

With the brake pedal in the rest position, turn the adjustment bolt (Item 1) so that it is 0.31 in. (8 mm) away from the switch body (Item 2) [Figure 60-150-3].

Check that the potentiometer rod (Item 3) [Figure 60-150-3] is in contact with the center of the adjusting bolt.

When adjustment is complete, tighten the nut (Item 4) [Figure 60-150-3] without turning the adjusting bolt.



**Bobcat®**

## SERVICE SOFTWARE

### Connecting The Laptop Computer

Figure 60-160-1

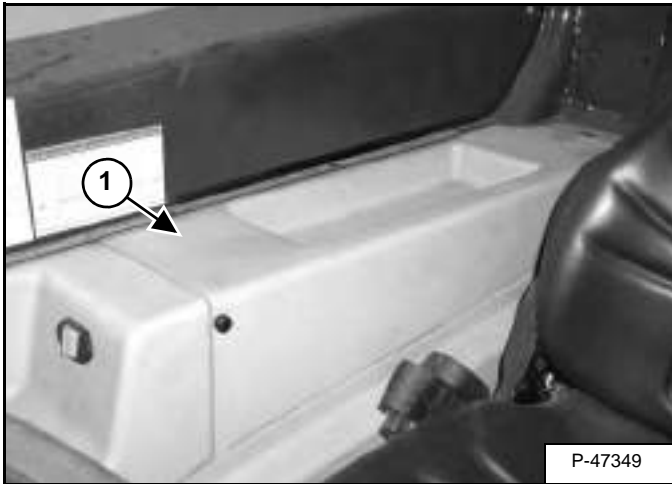

Remove the console cover (Item 1) [Figure 60-160-1].

Figure 60-160-2

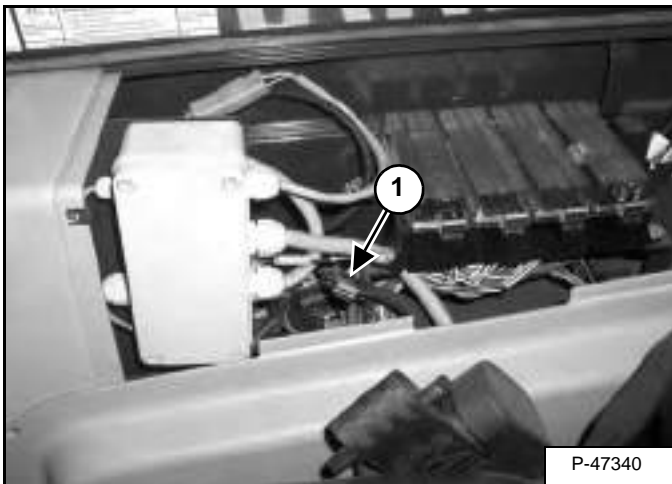

Locate the nine pin connector (Item 1) [Figure 60-160-2].

Figure 60-160-3

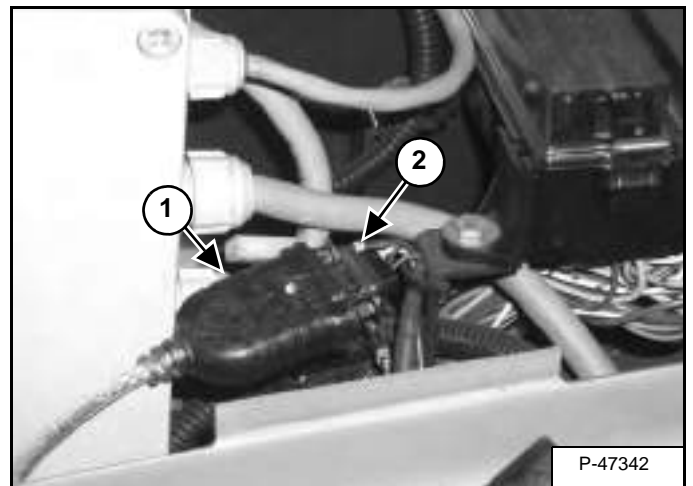

Plug the connector (Item 1) from the laptop computer into the nine pin connector (Item 2) [Figure 60-160-3].

Figure 60-160-4



Open the laptop and begin [Figure 60-160-4].

## SERVICE SOFTWARE (CONT'D)

### Entering The Service Software

Figure 60-160-5

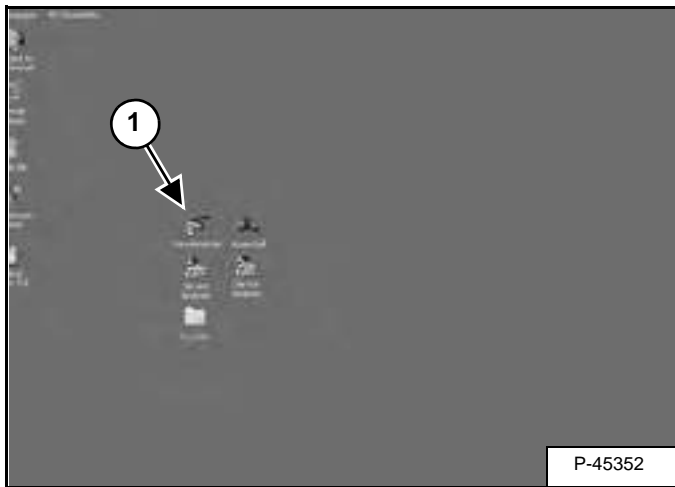

Click the Telescopic Handler icon (Item 1) [Figure 60-160-5] to enter the program.

Figure 60-160-6



The option screen will appear when entering the Telescopic Handler service analyzer [Figure 60-160-6]. The com port can be changed, if com port 1 is already being used.

Figure 60-160-7



This is the Main Screen of the Telescopic Handler analyzer program [Figure 60-160-7].

Figure 60-160-8

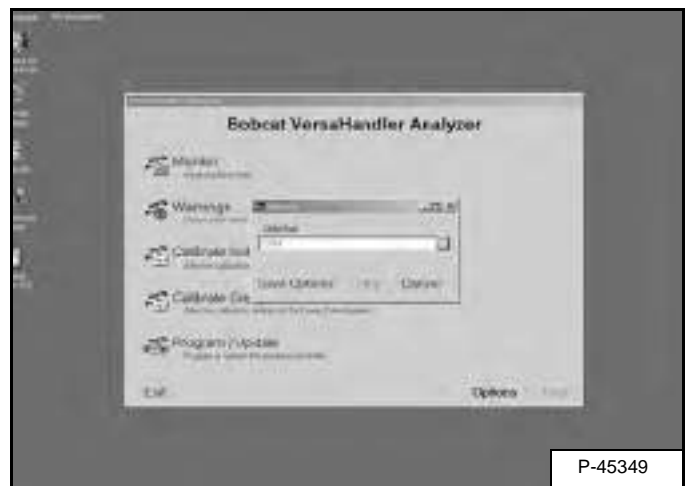

The options icon will take you to the options screen [Figure 60-160-8]. The com port can be changed, if com port 1 is already being used.

## SERVICE SOFTWARE (CONT'D)

### Monitor Screen

Figure 60-160-9

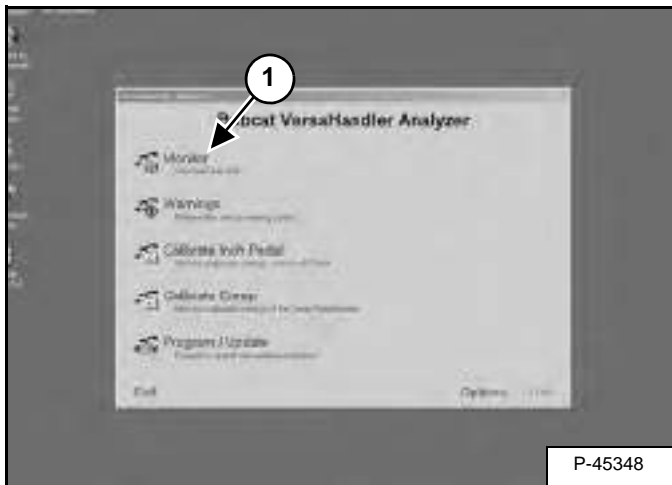

Select the Monitor icon (Item 1) [Figure 60-160-9].

Figure 60-160-10



The Monitor screen displays the engine RPM, travel control position, battery voltage, propel curve, sensor voltage, brake release switch, inch / brake pedal, creep potentiometer (is so equipped), transmission mode, drive switch and creep switch [Figure 60-160-10].

If one of the icons does not change when the function is operated, the circuit is not operating properly or the susmic controller has a malfunction.

Figure 60-160-11

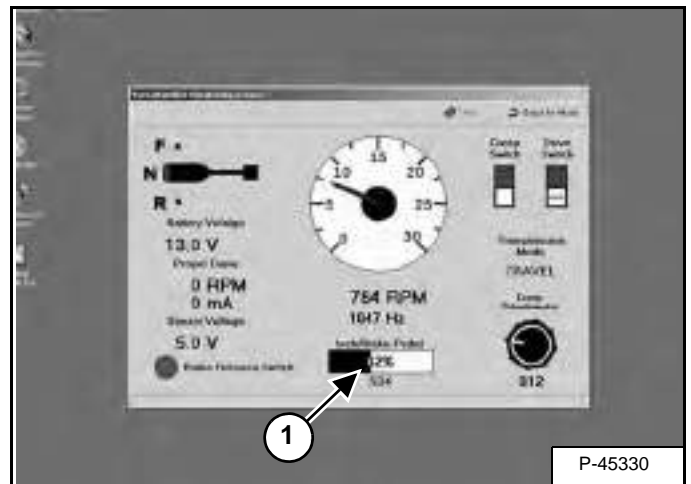

The Inch / Brake pedal graph (Item 1) [Figure 60-160-11] should move as the pedal is pressed down.

Figure 60-160-12

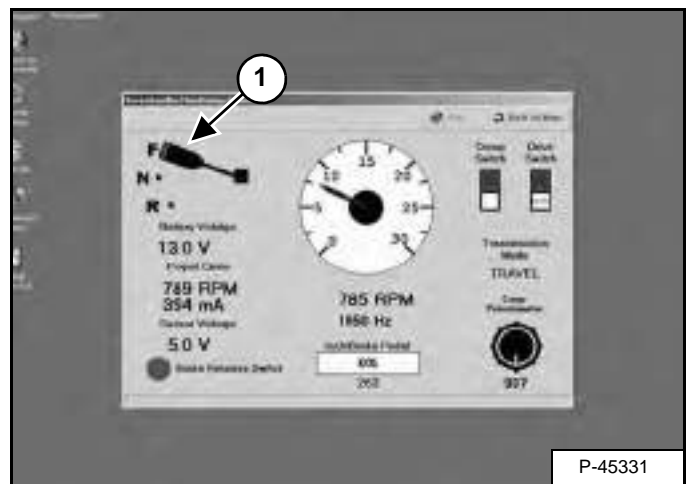

The travel control position lever (Item 1) [Figure 60-160-12] should move as the lever in the Telescopic Handler is moved.

## SERVICE SOFTWARE (CONT'D)

### Monitor Screen (Cont'd)

Figure 60-160-13

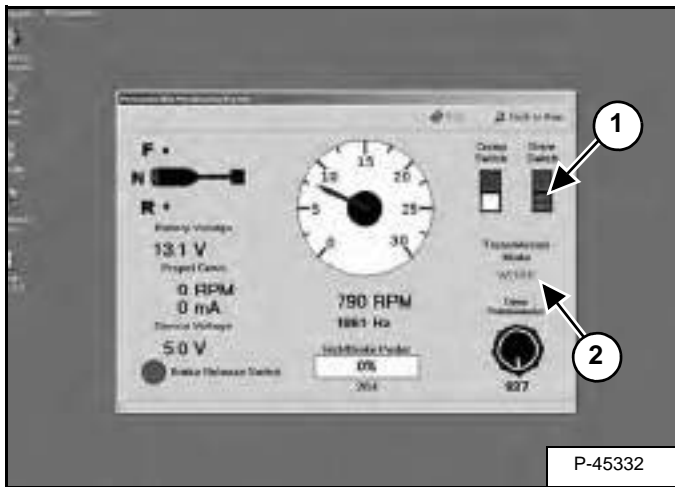

The Work Switch is turned on, the icon (Item 1) will turn on and the Transmission mode will change to work (Item 2) [Figure 60-160-13].

Figure 60-160-14

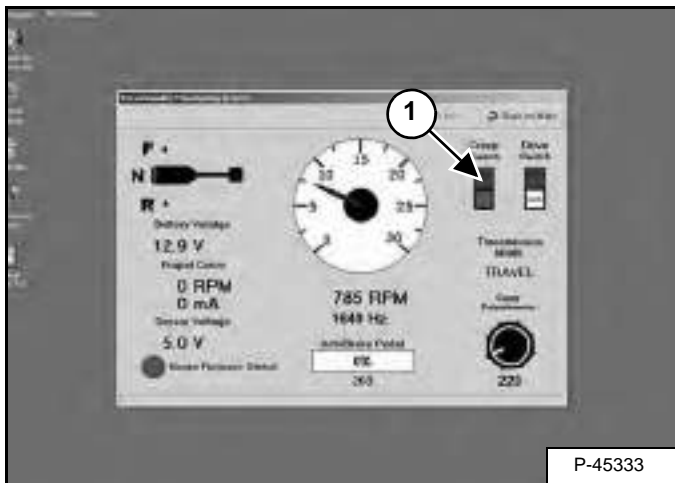

With the Creep Switch turned on, the icon (Item 1) [Figure 60-160-14] will turn on. The creep potentiometer icon will change as the creep adjustment is turned.

### Warnings Screen

Figure 60-160-15

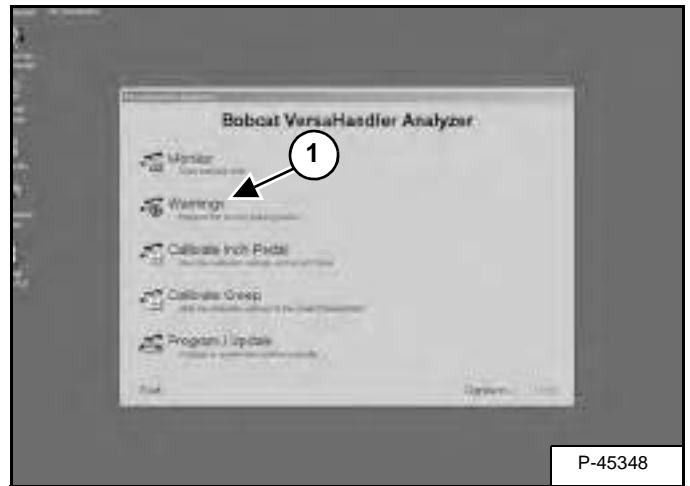

Select on the warning icon (Item 1) [Figure 60-160-15].

Figure 60-160-16

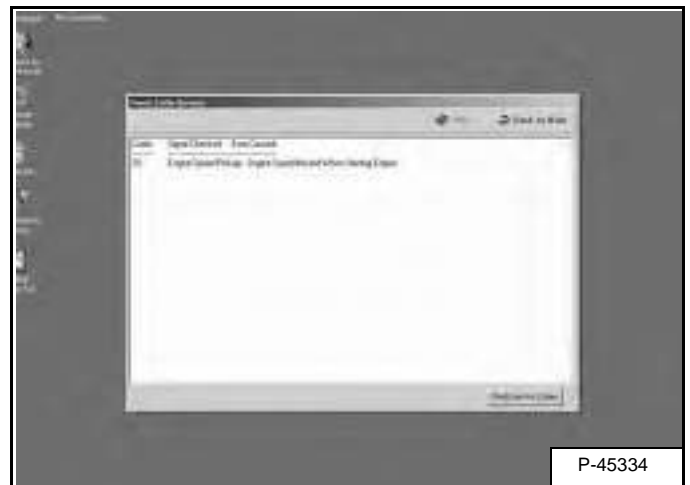

The warning screen will show codes and problem with the controller [Figure 60-160-16].



## SERVICE SOFTWARE (CONT'D)

### Warnings Screen (Cont'd)

Error #	Description
01	Sensor supply voltage-sensor voltage out of range
17	Software did not load properly-Restart program and reload software
18	Inch pedal calibration failed-recalibrate the inch pedal
19	Inch / brake potentiometer-no pedal setup done, value too low, value too high
20	Engine speed pickup-engine speed missed when starting engine
21	Propel current-short cut, open circuit
22	F-N-R switch-short cut between forward and reverse
23	Engine speed pickup-engine speed interrupted
24	Hydro motor propel current-short cut, open circuit
25	Creep drive calibration failed-recalibrate the creep drive potentiometer
26	Creep drive potentiometer-value too low, value too high
27	Motor speed pickup-motor speed interrupted

### Calibrate Inch Pedal

Figure 60-160-17

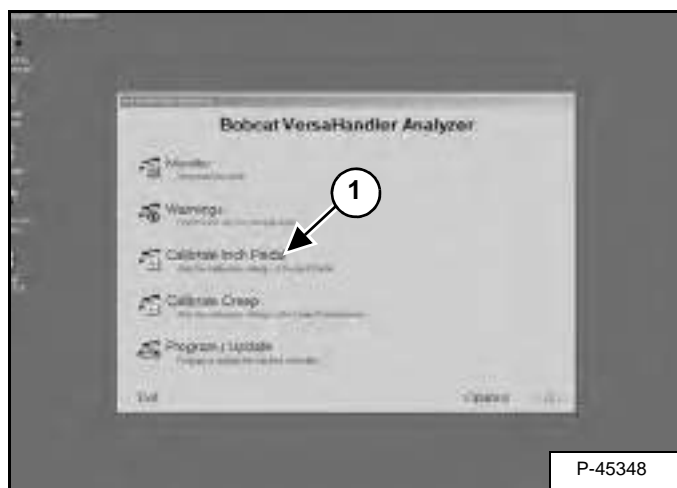

Select the calibrate inch pedal icon (Item 1)  
[Figure 60-160-17].

Figure 60-160-18

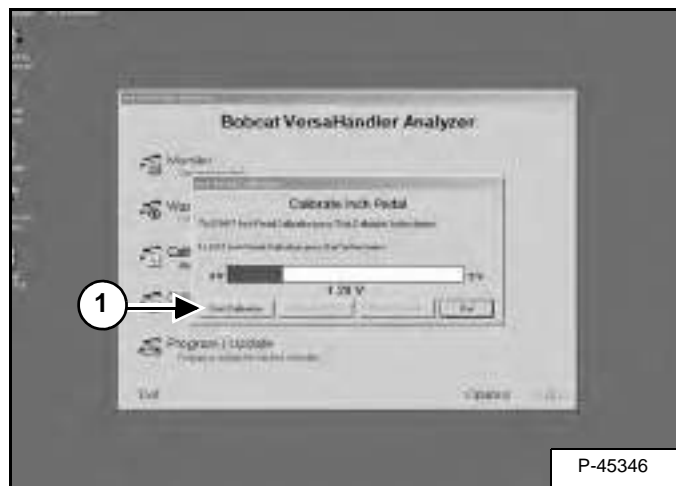

Click on the Start Calibration (Item 1)  
[Figure 60-160-18].

## SERVICE SOFTWARE (CONT'D)

### Calibrate Inch Pedal (Cont'd)

Figure 60-160-19

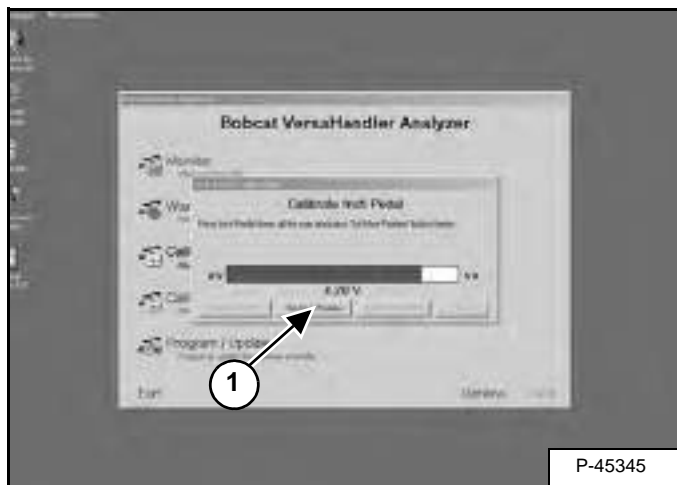

Press the brake pedal down approximately 1/2 the stroke and click on the set max position icon (Item 1) [Figure 60-160-19].

Figure 60-160-20

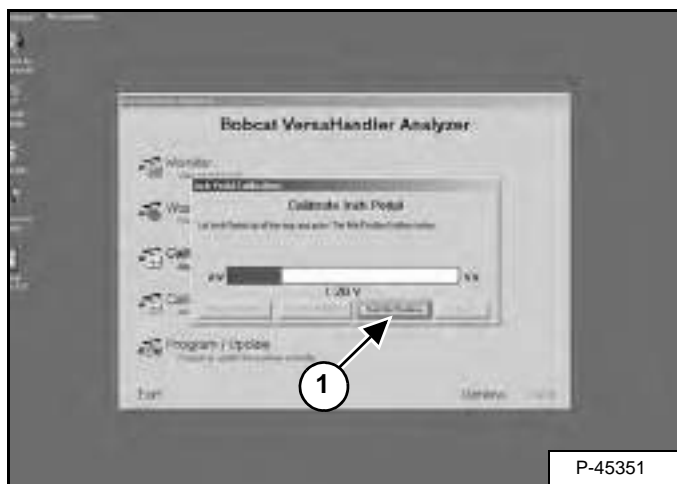

Release the brake pedal and click on the set min position icon (Item 1) [Figure 60-160-20].

Figure 60-160-21

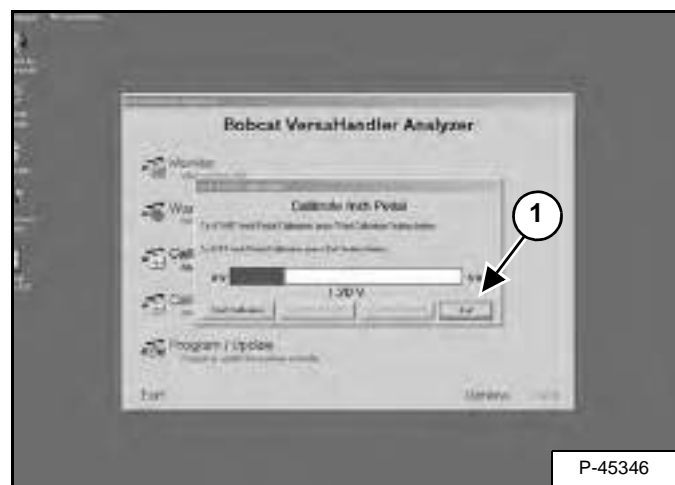

Click the exit (Item 1) [Figure 60-160-21] to get out of the calibrate inch pedal.

## SERVICE SOFTWARE (CONT'D)

### Calibrate Creep Potentiometer

Figure 60-160-22

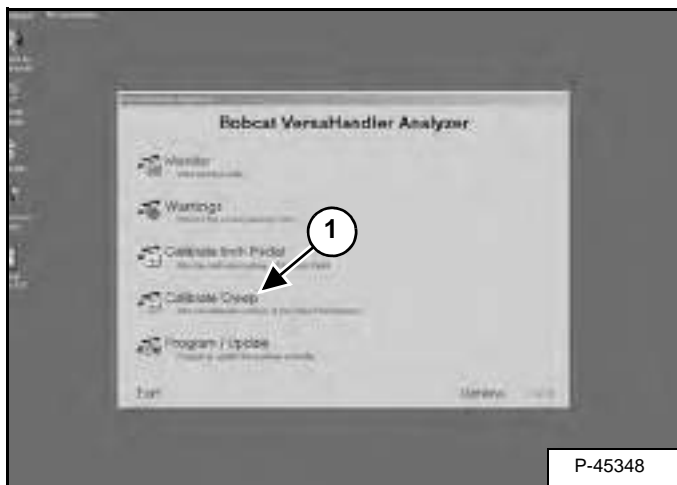

Select the calibrate creep icon (Item 1) [Figure 60-160-22].

Figure 60-160-23

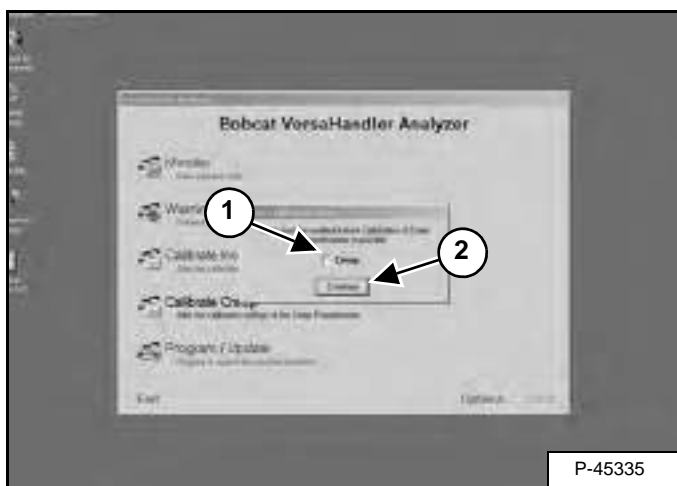

Select the creep box (Item 1) and then click the continue icon (Item 2) [Figure 60-160-23].

Figure 60-160-24

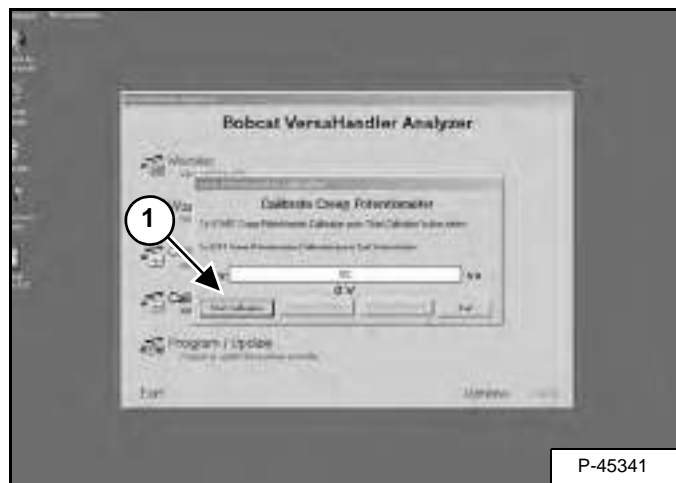

Click the start calibration icon (Item 1) [Figure 60-160-24].

Figure 60-160-25

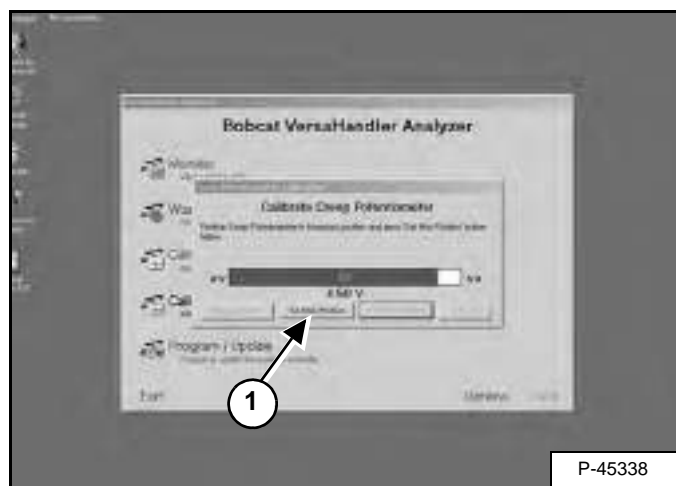

Turn the creep knob clockwise and click the set max position icon (Item 1) [Figure 60-160-25].

## SERVICE SOFTWARE (CONT'D)

### Calibrate Creep Potentiometer (Cont'd)

Figure 60-160-26

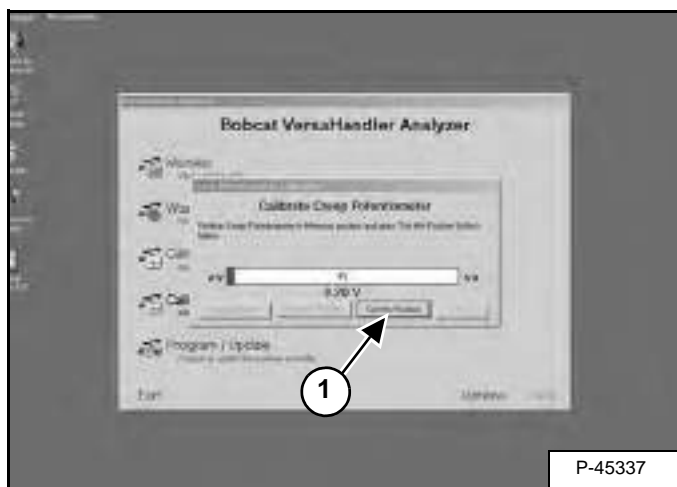

Turn the creep potentiometer counter-clockwise and click on the set min position icon (Item 1) [Figure 60-160-26].

Figure 60-160-27

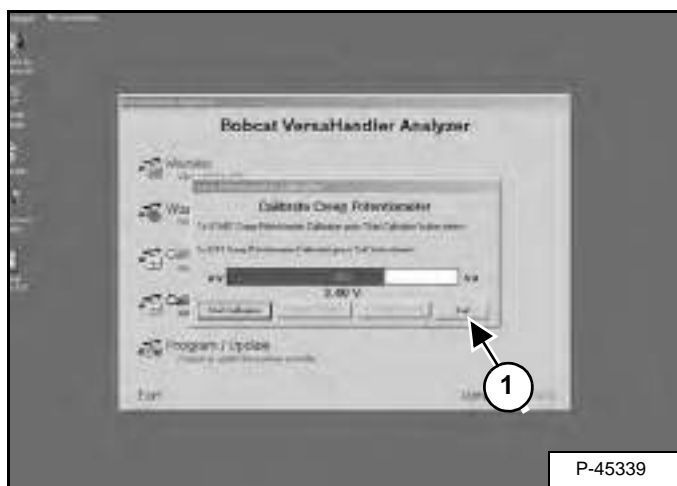

Click the exit icon (Item 1) [Figure 60-160-27] to leave the creep calibration screen.

### Program / Update Susmic Controller

Figure 60-160-28

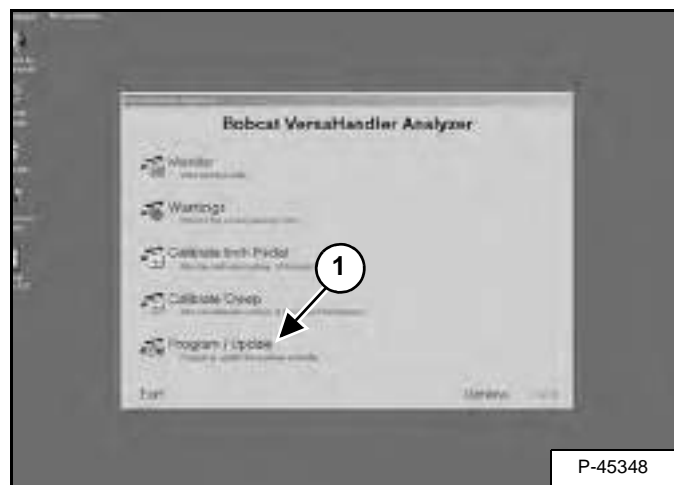

Select the Program / Update icon (Item 1) [Figure 60-160-28].

Figure 60-160-29

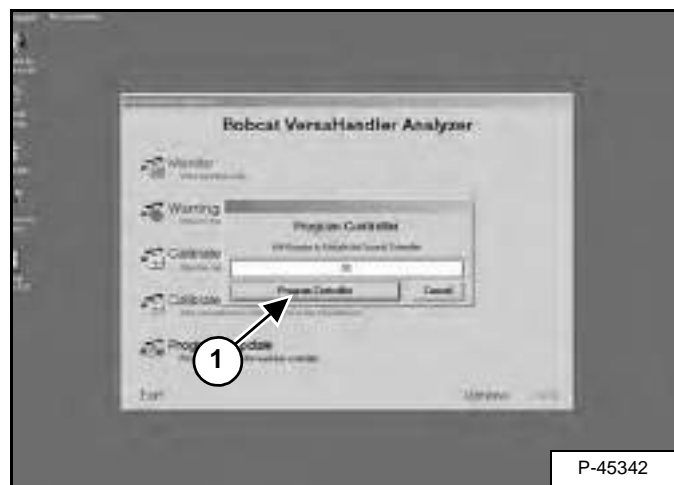

Click the program controller icon (Item 1) [Figure 60-160-29].

---

## SERVICE SOFTWARE (CONT'D)

### Program / Update Susmic Controller (Cont'd)

Figure 60-160-30

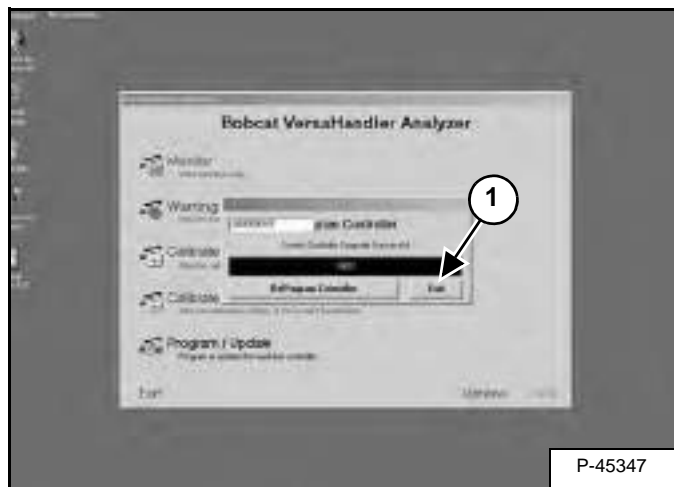

Click the exit icon (Item 1) [Figure 60-160-30] after the controller has been programmed.



**Bobcat®**

## FRAME LEVEL SPEED SWITCH

### Description

Figure 60-170-1

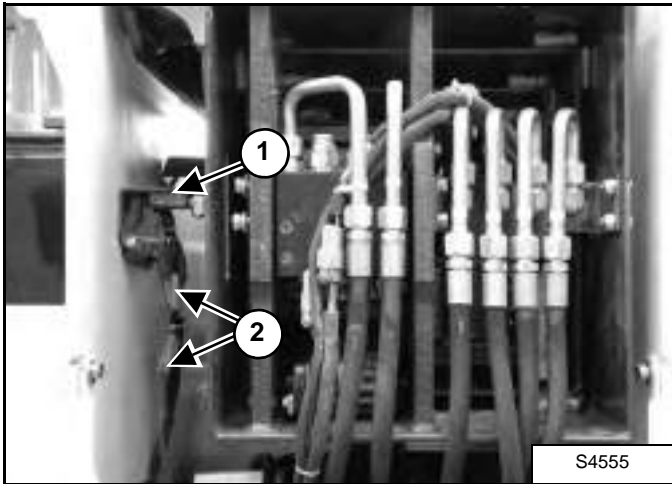

The T40170 is equipped with three frame level speed switches (Item 1) [Figure 60-170-1] located on the left rear side of the boom. This switches reduces the speed of the frame leveling after the boom is raised over 25 degrees.

### Removal

Lower the boom completely and turn off the engine.

Figure 60-170-2



Remove the rear cover (Item 1) [Figure 60-170-2].

Unplug the three harness connectors (Item 2) [Figure 60-170-1].

Figure 60-170-3

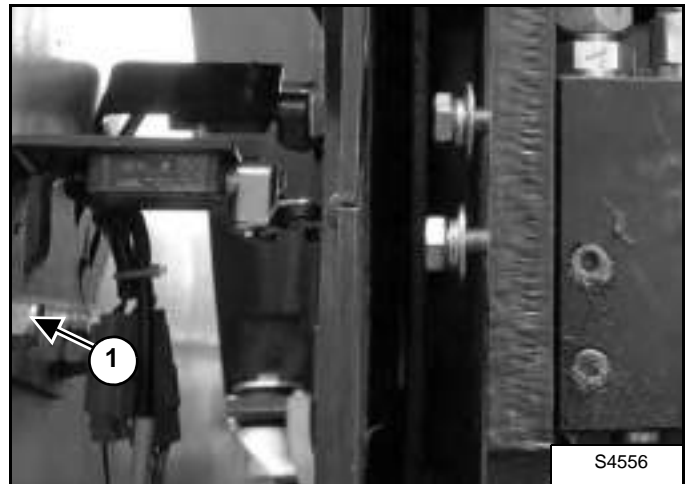

Remove the two bolts (Item 1) [Figure 60-170-3] and remove the switch / bracket assembly.

## FRAME LEVEL SPEED SWITCH (CONT'D)

### Installation

Figure 60-170-4

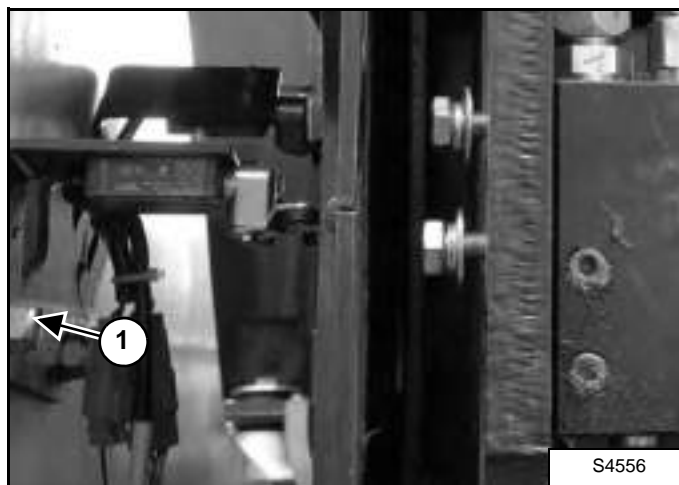

Install the switch / bracket assembly using the two bolts (Item 1) [Figure 60-170-4]. Do not tighten bolts at this time.

Figure 60-170-5

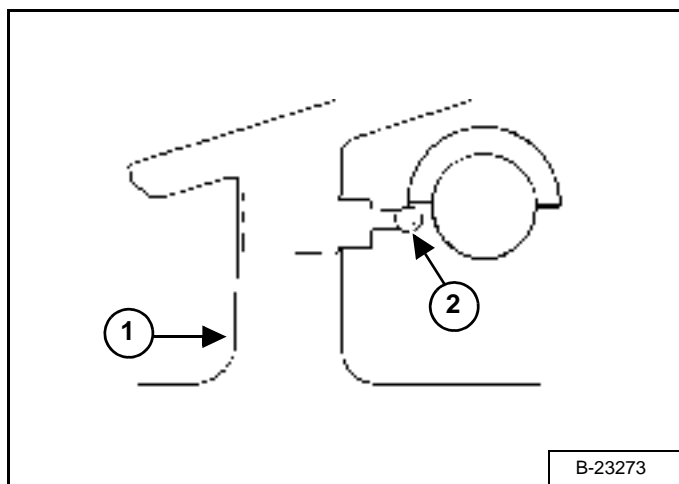

Slide the switch / bracket assembly (Item 1) until the switch roller (Item 2) [Figure 60-170-5] is in the position shown.

Tighten the bolts (Item 1) [Figure 60-170-4].

Figure 60-170-6

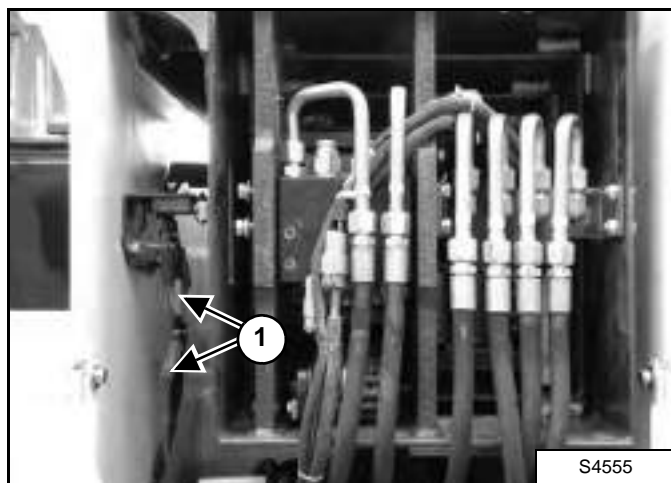

Plug the connectors (Item 1) [Figure 60-170-6] into the harness.

Figure 60-170-7

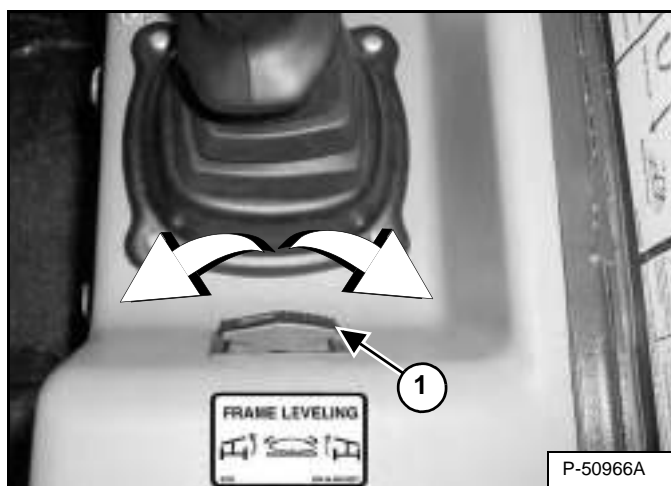

Start the engine.

While holding the frame leveling switch (Item 1) [Figure 60-170-7] raise the boom. When the boom reaches 25 degrees the speed of the frame leveling should decrease.



---

## FRAME LEVEL SPEED SWITCH (CONT'D)

### Disassembly And Assembly

Remove the frame level speed switch (See "Removal" on page 60-170-1).

**Figure 60-170-8**

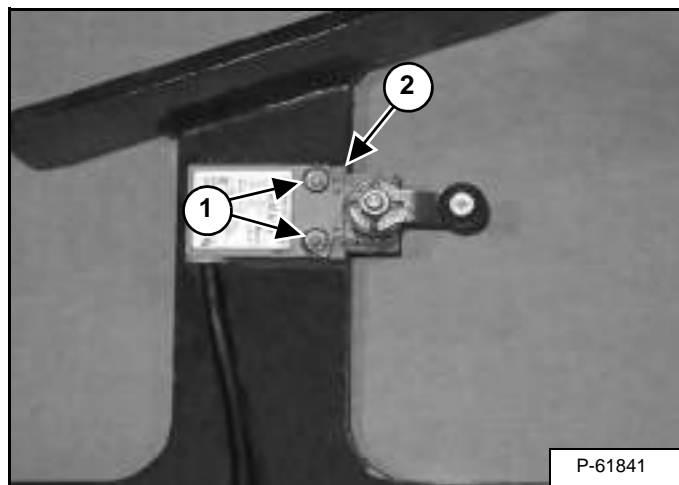

Remove the two bolts and nuts (Item 1) and remove the switch (Item 2) **[Figure 60-170-8]**.



**Bobcat®**

## JOYSTICK

### Removal And Installation

Figure 60-180-1

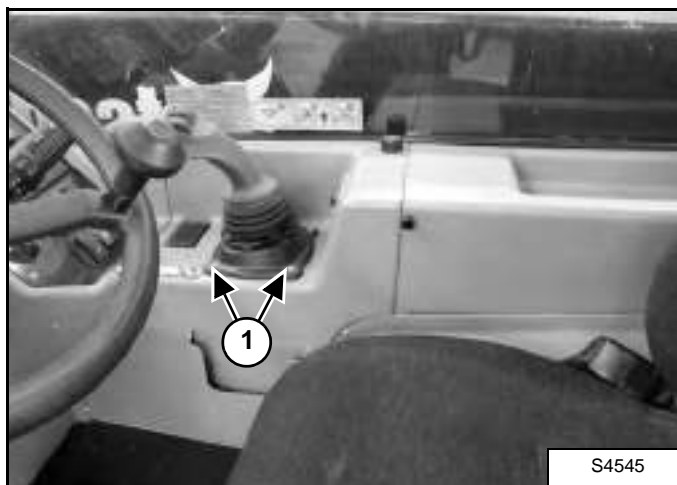

Remove the four joystick mounting screws (Item 1) [Figure 60-180-1] and pull the joystick upwards.

**NOTE:** The joystick is not serviceable and must be replaced as a complete unit.

Figure 60-180-2

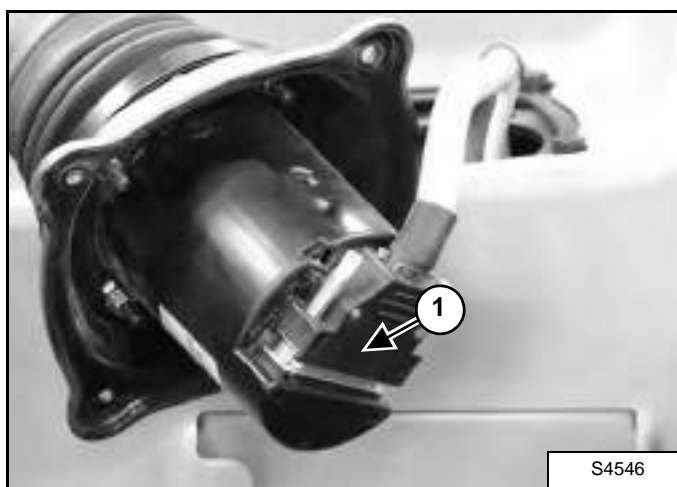

Disconnect the electrical connector by loosening the screws (Item 1) [Figure 60-180-2] and pulling it back.



**Bobcat®**

---

## ENGINE SERVICE

AIR CLEANER . . . . .	70-40-1
Housing Removal And Installation. . . . .	70-40-1
ENGINE AND ENGINE MOUNTS . . . . .	70-60-1
Removal And Installation. . . . .	70-60-1
ENGINE COMPONENTS AND TESTING . . . . .	70-70-1
Checking The Fuel Lift Pump . . . . .	70-70-9
Compression Checking . . . . .	70-70-10
Glow Plugs Checking . . . . .	70-70-11
Glow Plugs Removal And Installation . . . . .	70-70-12
Fuel Injection Pump Installation . . . . .	70-70-4
Fuel Injection Pump Removal . . . . .	70-70-1
Fuel Injectors Removal And Installation . . . . .	70-70-7
Fuel Lift Pump Removal And Installation. . . . .	70-70-10
ENGINE / HYDROSTAT ASSEMBLY . . . . .	70-80-1
Removal And Installation. . . . .	70-80-1
ENGINE SPEED CONTROL . . . . .	70-20-1
Removal And Installation. . . . .	70-20-1
ENGINE TIMING . . . . .	70-71-1
Procedure . . . . .	70-71-1
FLYWHEEL AND HOUSING . . . . .	70-90-1
Removal And Installation. . . . .	70-90-1
Ring Gear Installation . . . . .	70-90-4
Ring Gear Removal. . . . .	70-90-4
MUFFLER. . . . .	70-30-1
Removal And Installation. . . . .	70-30-1
OIL COOLER / RADIATOR. . . . .	70-50-1
Disassembly And Assembly . . . . .	70-50-3
Removal And Installation. . . . .	70-50-1

**ENGINE  
SERVICE**

**Continued On Next Page**

---

## ENGINE SERVICE (CONT'D)

RECONDITIONING THE ENGINE	70-100-1
Camshaft And Tappets Installation	70-100-24
Camshaft And Tappets Removal	70-100-23
Changing Valve Springs (With Cylinder Head Installed)	70-100-17
Checking Crankshaft End Play	70-100-36
Checking Piston Height	70-100-31
Connecting Rod Bushing Replacement	70-100-29
Connecting Rod Inspection	70-100-29
Cooling System Description	70-100-37
Crankshaft And Bearings Description	70-100-31
Crankshaft And Bearings Installation	70-100-34
Crankshaft And Bearings Removal	70-100-31
Crankshaft Pulley Removal And Installation	70-100-19
Cutting A Valve Seat	70-100-15
Cylinder Head Inspection	70-100-8
Cylinder Head Installation	70-100-8
Cylinder Head Removal	70-100-6
Cylinder Liner Inspection	70-100-47
Cylinder Liner Installation	70-100-49
Cylinder Liner Removal	70-100-48
Engine Block Description	70-100-45
Engine Block Disassembly And Assembly	70-100-45
Engine Lubrication System Description	70-100-40
Exhaust Manifold Removal And Installation	70-100-4
Fuel Injector Cover Removal And Installation	70-100-4
Front Oil Seal Removal And Installation	70-100-19
Inspection	70-100-46
Inspection Of Crankshaft And Bearings	70-100-33
Lubricating Oil Cooler Removal And Installation	70-100-39
Oil Filter Adapter Removal And Installation	70-100-41
Oil Pan Removal And Installation	70-100-41
Oil Pressure Relief Valve Disassembly And Assembly	70-100-44
Oil Pump Disassembly And Assembly	70-100-44
Oil Pump Installation	70-100-43
Oil Pump Removal	70-100-42
Oil Screen And Pick-up Tube	70-100-42
Piston And Connecting Rod Assembly	70-100-29
Piston And Connecting Rod Installation	70-100-29
Piston Cooling Jet Alignment	70-100-46
Piston Cooling Jet Installation	70-100-46
Piston Cooling Jet Removal	70-100-46
Piston Ring End Gap	70-100-27
Piston Ring Groove Clearance	70-100-28
Piston Ring Installation	70-100-27

Continued On Next Page

---

## ENGINE SERVICE (CONT'D)

RECONDITIONING THE ENGINE . . . . .	70-100-1
Pistons And Connecting Rods Description . . . . .	70-100-25
Pistons And Connecting Rods Disassembly . . . . .	70-100-27
Pistons And Connecting Rods Removal . . . . .	70-100-25
Rear Oil Seal Housing Positioning . . . . .	70-100-35
Rear Oil Seal Installation . . . . .	70-100-36
Rear Oil Seal Removal . . . . .	70-100-35
Rocker Cover Removal And Installation . . . . .	70-100-5
Rocker Shaft Disassembly And Assembly . . . . .	70-100-11
Thermostat Removal and Installation . . . . .	70-100-38
Thermostat Testing . . . . .	70-100-39
Timing Case And Drive Assembly Description . . . . .	70-100-19
Timing Case And Gear Installation . . . . .	70-100-21
Timing Case And Gear Removal . . . . .	70-100-20
Timing Cover Installation . . . . .	70-100-19
Timing Cover Removal . . . . .	70-100-19
Turbo Charger Description . . . . .	70-100-2
Turbo Charger Removal And Installation . . . . .	70-100-2
Turbo Charger Troubleshooting . . . . .	70-100-1
Valve Clearance Adjustment . . . . .	70-100-18
Valve Depth Checking . . . . .	70-100-12
Valve Guides Checking . . . . .	70-100-13
Valve Guide Installation . . . . .	70-100-14
Valve Guide Removal . . . . .	70-100-14
Valve Removal . . . . .	70-100-11
Valve Seat Assembly . . . . .	70-100-16
Valve Springs Checking . . . . .	70-100-12
Valves Checking . . . . .	70-100-15
Water Pump Installation . . . . .	70-100-39
Water Pump Removal . . . . .	70-100-39
TROUBLESHOOTING . . . . .	70-10-1
Chart . . . . .	70-10-1



**Bobcat®**



---

## TROUBLESHOOTING

### Chart

The following troubleshooting chart is provided for assistance in location and correcting problems which are most common. Many of the recommended procedures must be done by authorized Bobcat Service Personnel only.

<b>PROBLEM</b>	<b>CAUSE</b>
Slow cranking speed.	1, 2, 3, 4
Engine will not start (cold).	2, 5, 6, 7
Engine will not start.	1, 2, 3, 4, 5, 6, 7, 8, 9, 10
Difficult to start.	1, 2, 3, 4, 5, 6, 7, 8, 9, 10, 11, 12, 13, 14, 15, 16, 18, 19, 20, 21
No power for engine.	9, 11, 15, 16, 17, 18, 19, 21, 22, 25, 26, 27
Engine is mis-firing.	11, 15, 16, 17, 18, 19, 20, 21, 22, 23, 24
Too much fuel consumption.	7, 16, 17, 18, 20, 21, 22, 28, 29, 30
Black exhaust.	16, 17, 18, 19, 20, 22, 25, 27
Blue / white exhaust.	4, 7, 16, 18, 19, 22, 31, 32
Low oil pressure.	4, 31, 32, 33, 34, 35, 37, 38, 39, 48, 51
Engine knocking.	4, 5, 17, 18, 19, 20, 23, 34, 35, 36, 37, 38
Engine running rough.	7, 8, 9, 10, 11, 12, 13, 14, 20, 21, 22, 25, 26, 27, 28, 29, 40, 52
Vibration	16, 30, 50, 51, 52
High oil pressure warning.	4, 33, 36
Overheating.	18, 19, 20, 22, 25, 31, 33, 46, 47, 48, 49
Too much crankcase pressure.	25, 35, 36, 42
Poor compression.	17, 18, 22, 23, 30, 32, 34, 35, 36, 44
Start and stop.	9, 11, 13, 15, 17, 22, 23, 30
Excessive oil consumption	4, 22, 32, 36, 40, 41, 42, 43, 44, 45

## TROUBLESHOOTING (CONT'D)

### Chart (Cont'd)

KEY TO CORRECT THE CAUSE	
1. Battery capacity low.	27. Poor boost pressure.
2. Bad electrical connections	28. Fuel leak.
3. Faulty starter motor.	29. Lubrication oil diluted by fuel.
4. Incorrect grade of oil.	30. Sticking valves.
5. Incorrect grade of fuel.	31. Leaking head gasket.
6. Incorrect use of cold starting equipment.	32. Worn valve guides/stems.
7. Faulty cold starting equipment.	33. Faulty thermostat.
8. Insufficient fuel in tank.	34. Incorrect piston height.
9. Faulty stop control.	35. Broken / worn piston rings.
10. Broken fuel injection pump drive.	36. Worn cylinder liners.
11. Air in the fuel system	37. Worn wrist pins.
12. Restricted fuel feed.	38. Excessive camshaft end play.
13. Fuel tank vent blocked.	39. Excessive timing gear backlash.
14. Plugged fuel filters.	40. Oil leaks.
15. Faulty fuel pump.	41. New or rebuilt engine not broken in.
16. Low compression.	42. Plugged breather pipe.
17. Incorrect valve clearance.	43. Glazed cylinder liners.
18. Incorrect valve timing.	44. Worn pistons.
19. Incorrect fuel pump timing.	45. Worn valve stem seals.
20. Faulty injectors.	46. Coolant level low.
21. Faulty fuel injection pump.	47. Faulty water pump.
22. Plugged air filter.	48. Loose or broken blower fan belt.
23. Broken or weak valve springs.	49. Radiator cooling fins plugged.
24. Overheating.	50. Damaged blower fan.
25. Restricted exhaust system.	51. Loose flywheel.
26. Water in fuel.	52. Broken engine mounts.

## ENGINE SPEED CONTROL

### Removal And Installation

Figure 70-20-1

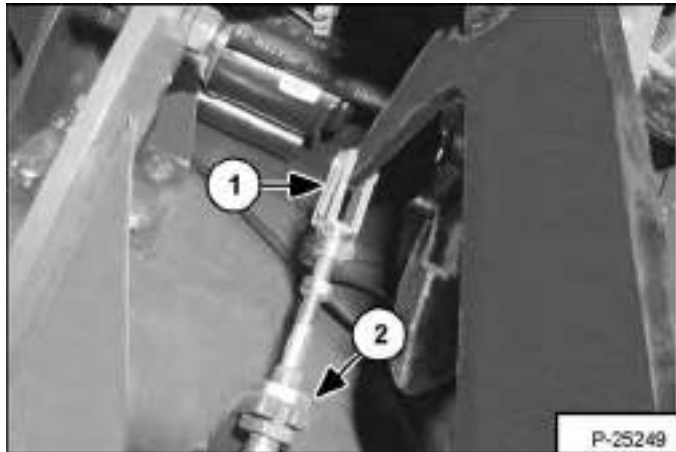

Remove the floor mat and insulation from the cab floor.

Remove the speed control cable (Item 1) from the pedal and mounting bracket (Item 2) [Figure 70-20-1].

Remove the battery box cover.

Figure 70-20-2.



Carefully pull the speed control cable (Item 1) [Figure 70-20-2] through the cab and into the battery box.

Figure 70-20-3

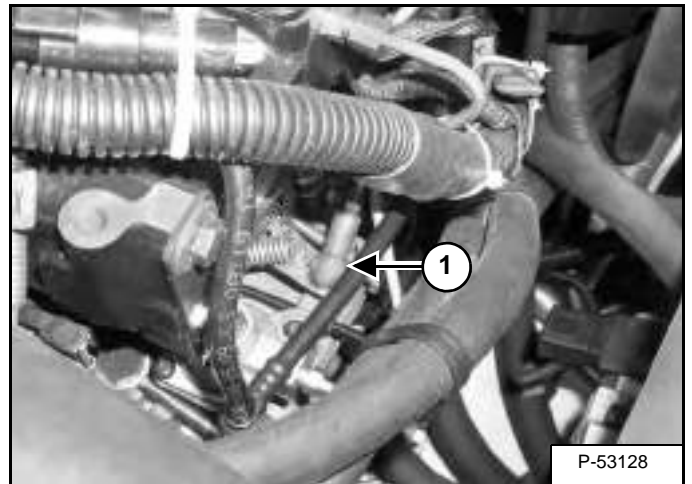

Open the engine cover.

Remove the engine speed control cable (Item 1) [Figure 70-20-3] from the linkage.

Figure 70-20-4

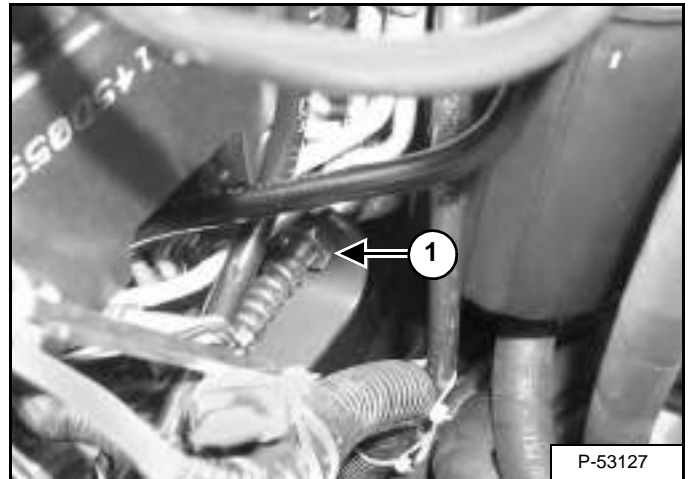

Remove the engine speed control cable from the mounting bracket (Item 2) [Figure 70-20-4].

Remove any necessary cable ties, carefully remove the speed control cable.



**Bobcat®**

## MUFFLER

### Removal And Installation

Figure 70-30-1

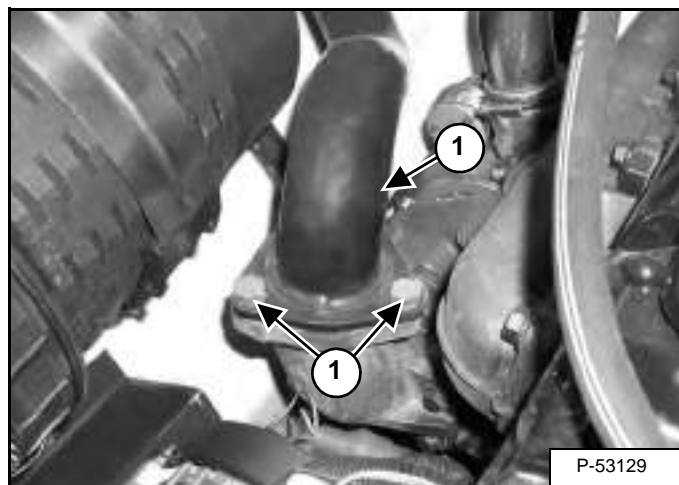

Open the engine cover.

Remove the three exhaust mounting bolts (Item 1) [Figure 70-30-1].

Figure 70-30-2

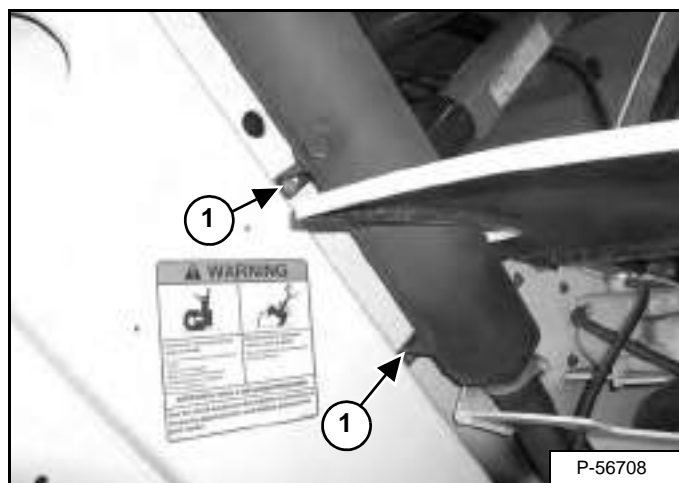

Remove the four muffer mounting bolts (Item 1) [Figure 70-30-2].

Remove the muffer.



**Bobcat®**

## AIR CLEANER

### Housing Removal And Installation

Figure 70-40-1

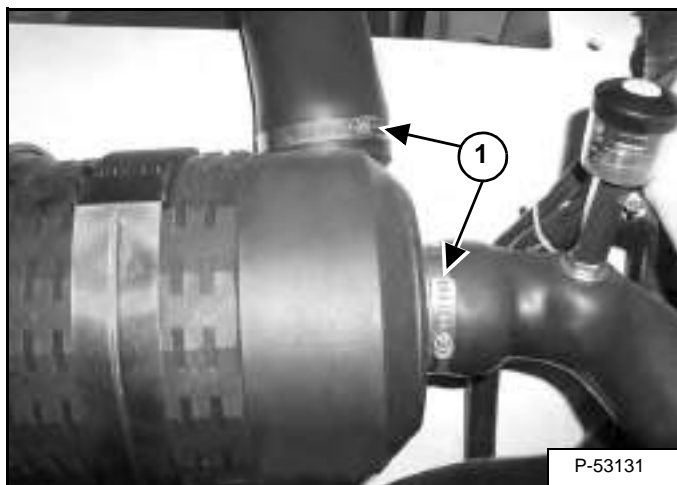

Open the engine cover.

Loosen the clamps (Item 1) [Figure 70-40-1] and remove the hoses from the air cleaner.

Figure 70-40-2

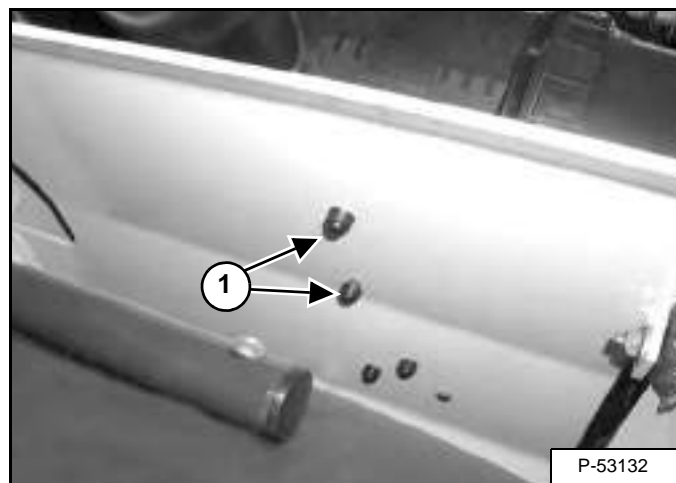

Remove both mounting bolts (Item 1) [Figure 70-40-2].

Remove the air cleaner housing assembly.



**Bobcat®**



## OIL COOLER / RADIATOR

### Removal And Installation

Remove the engine cover (See "Gas Cylinder Removal And Installation" on page 50-70-1).

Drain the hydraulic reservoir (See "Replacing Hydraulic Fluid" on page 10-100-2).

Drain the radiator (See "Removal And Installation" on page 70-50-1).

Remove the fan motor (See "Removal And Installation" on page 20-140-1).

**Figure 70-50-1**

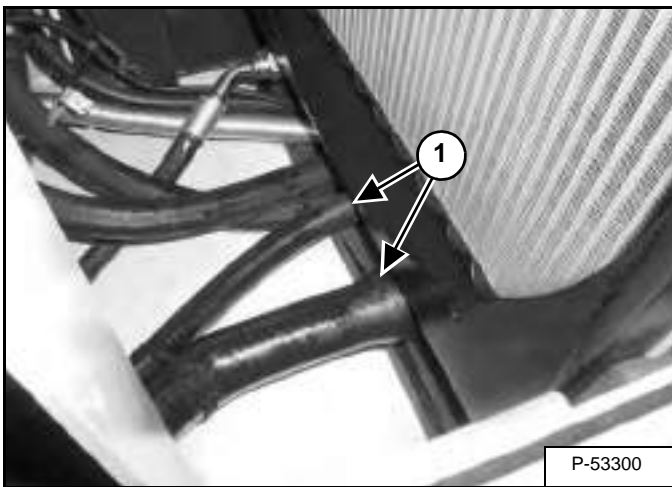

Remove the two lower radiator hoses (Item 1) [Figure 70-50-1].

**Figure 70-50-2**

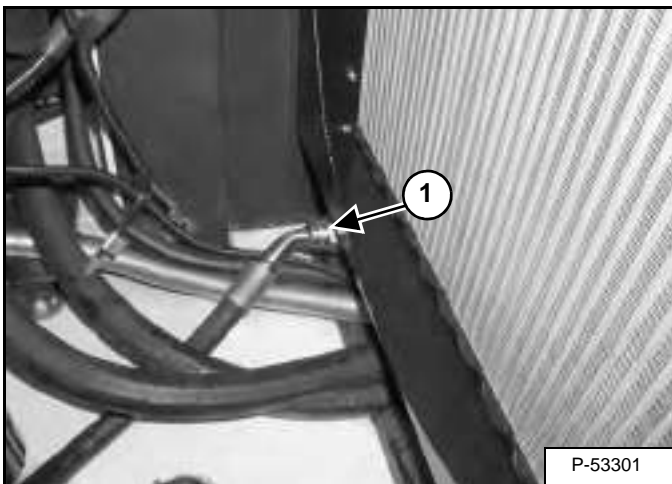

Remove the lower hydraulic hose (Item 1) [Figure 70-50-2].

**Figure 70-50-3**

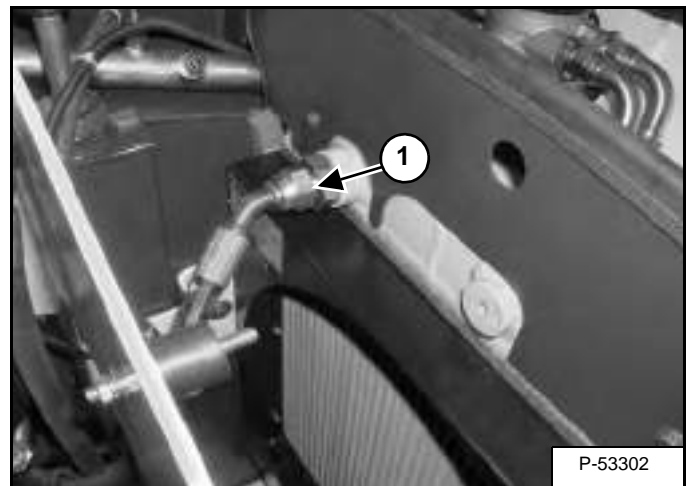

Remove the upper hydraulic hose (Item 1) [Figure 70-50-3].

**Figure 70-50-4**

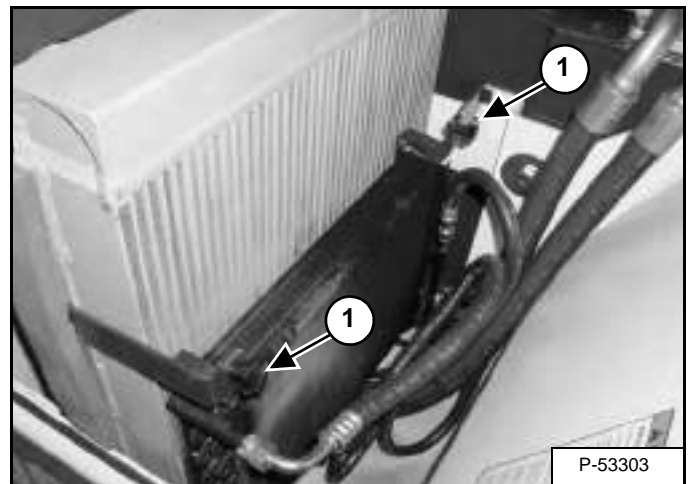

Remove the two nuts (Item 1) [Figure 70-50-4] from the condenser.

## OIL COOLER / RADIATOR (CONT'D)

### Removal And Installation (Cont'd)

Figure 70-50-5

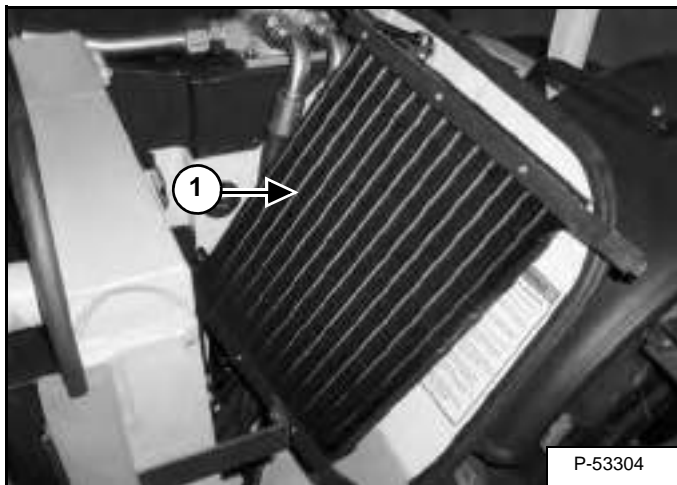

Position the condenser (Item 1) [Figure 70-50-5] (as shown).

Figure 70-50-6



Install a hoist and chain to the oil cooler / radiator [Figure 70-50-6].

Figure 70-50-7

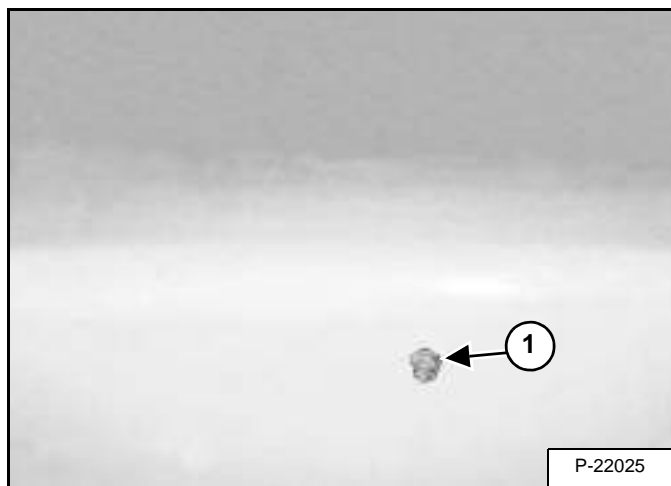

Remove both oil cooler / radiator mounting bolts (Item 1) [Figure 70-50-7] from the bottom of the engine pan.

Figure 70-50-8

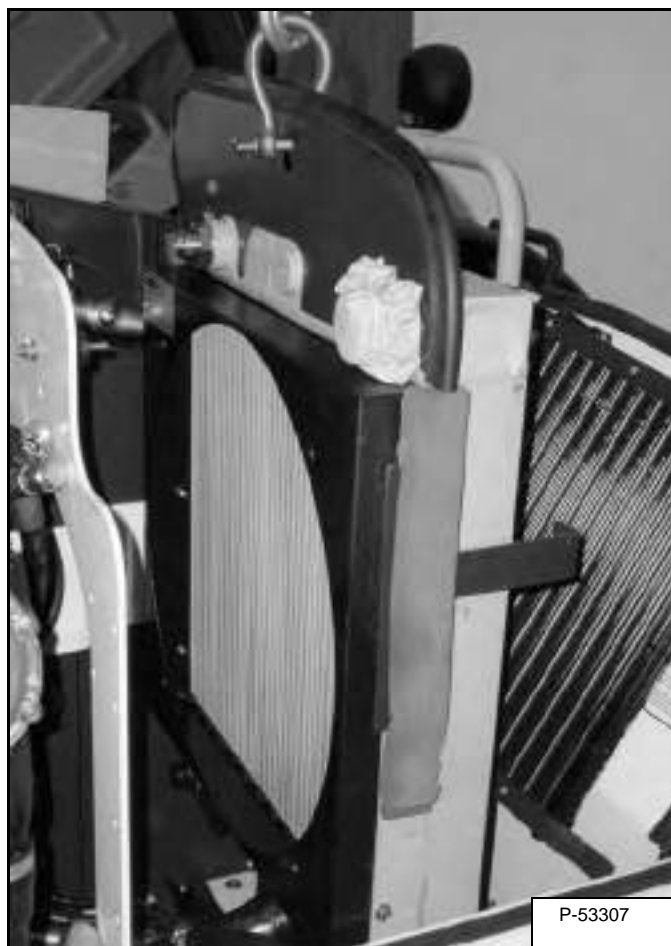

Lift and remove the oil cooler / radiator assembly [Figure 70-50-8].

## OIL COOLER / RADIATOR (CONT'D)

### Disassembly And Assembly

Figure 70-50-9

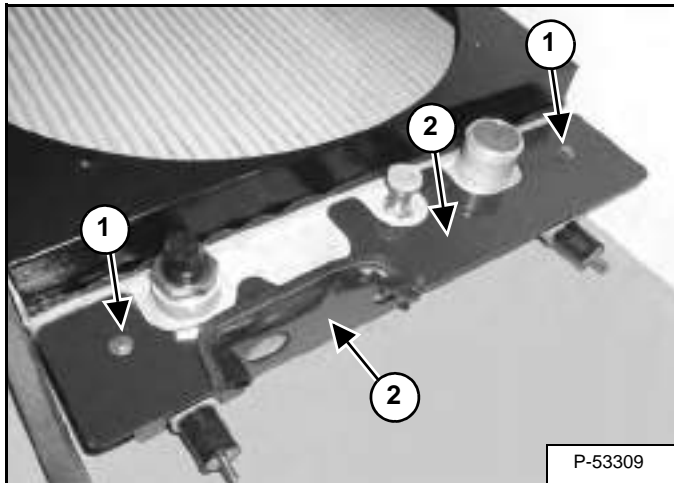

Remove the two bolts (Item 1) and remove the two brackets (Item 2) [Figure 70-50-9].

Figure 70-50-10

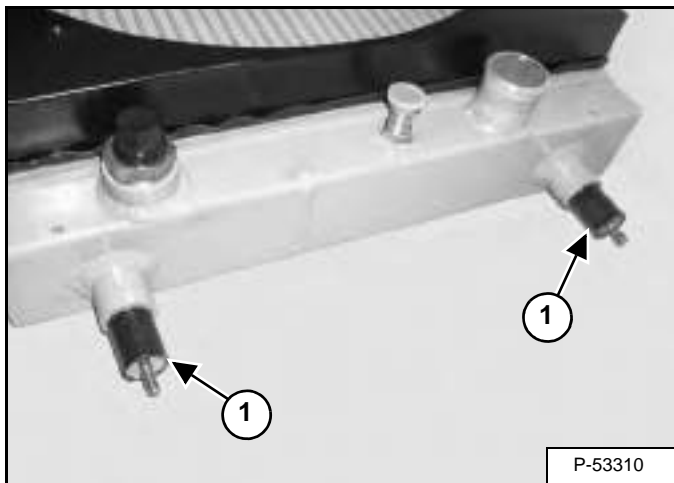

Remove both rubber mounts (Item 1) [Figure 70-50-10] by turning counterclockwise.

Figure 70-50-11

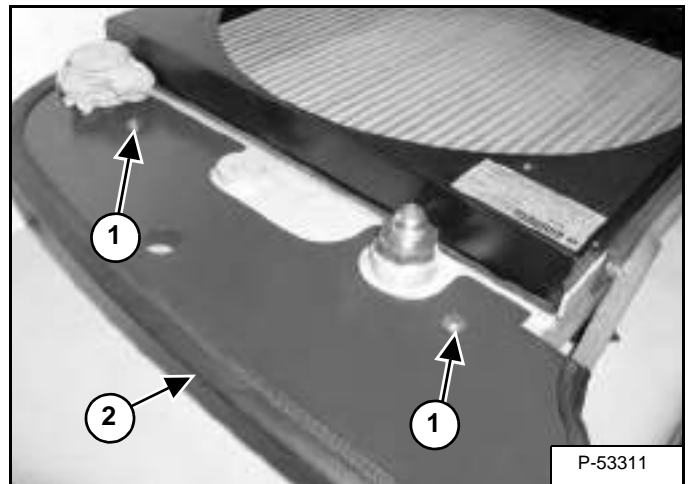

Remove the bolts (Item 1) and remove the upper bracket (Item 2) [Figure 70-50-11].

Figure 70-50-12

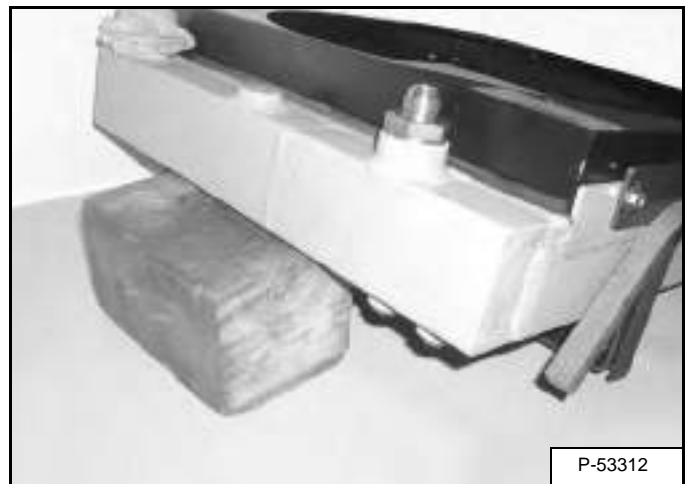

Support the oil cooler/radiator assembly as shown [Figure 70-50-12].

---

## OIL COOLER / RADIATOR (CONT'D)

### Disassembly And Assembly (Cont'd)

Figure 70-50-13

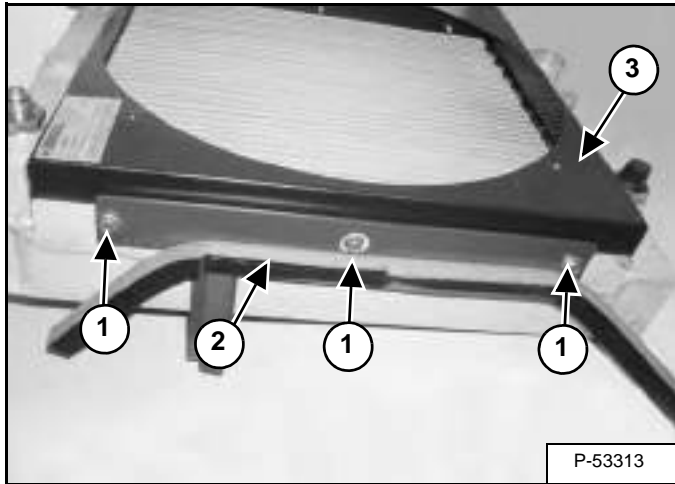

Remove the three bracket mounting bolts (Item 1) (both sides) and remove the condenser mounting bracket (Item 2) and shroud (Item 3) **[Figure 70-50-13]**.

## ENGINE AND ENGINE MOUNTS

### Removal And Installation

Remove the engine / hydrostatic assembly (See "Removal And Installation" on page 70-80-1).

**NOTE: Set the engine / hydrostatic assembly on blocks, to allow access to remove the motor mount bolts.**

Remove the hydrostatic pump (See "Removal And Installation" on page 30-40-1).

Remove the flywheel and housing (See "Removal And Installation" on page 70-90-1.)

If equipped with air conditioning, remove the hoses from the compressor (See "Removal And Installation" on page 80-110-1).

**Figure 70-60-1**

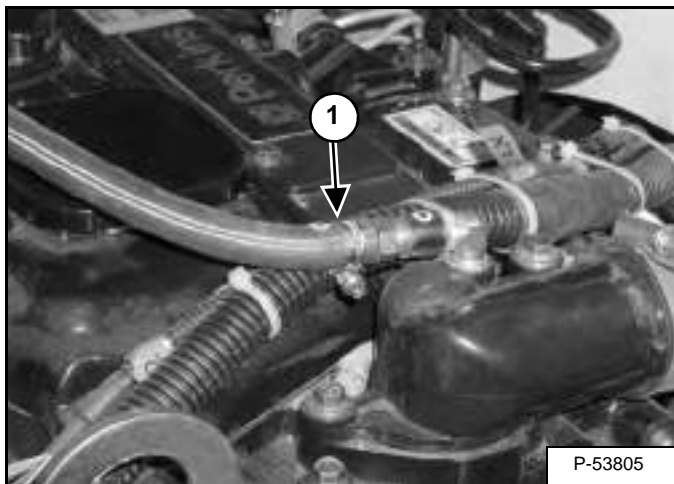

Remove the hose (Item 1) [Figure 70-60-1] from the thermostat housing.

**Figure 70-60-2**

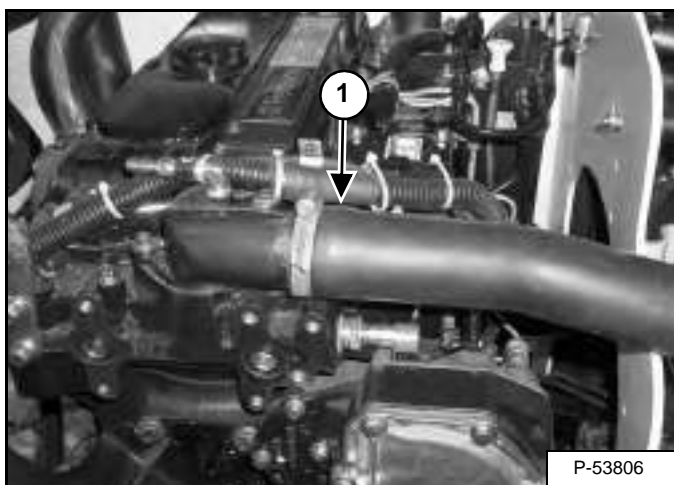

Remove the hose (Item 1) [Figure 70-60-2] and reposition.

**Figure 70-60-3**

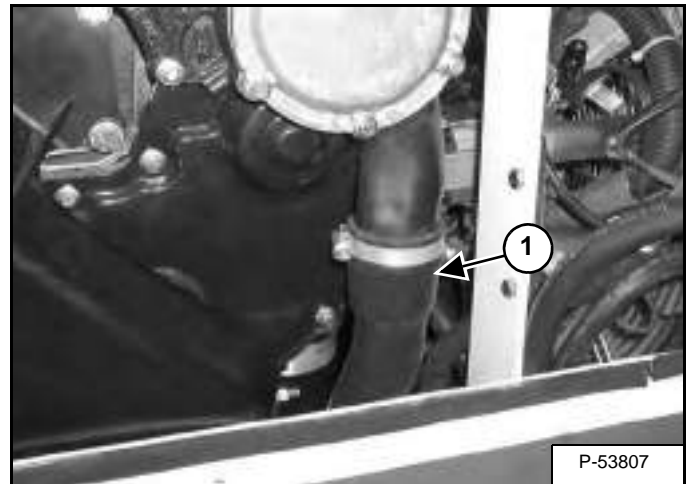

Remove the lower radiator hose (Item 1) [Figure 70-60-3] from the water pump.

## ENGINE AND ENGINE MOUNTS (CONT'D)

### Removal And Installation (Cont'd)

Figure 70-60-4

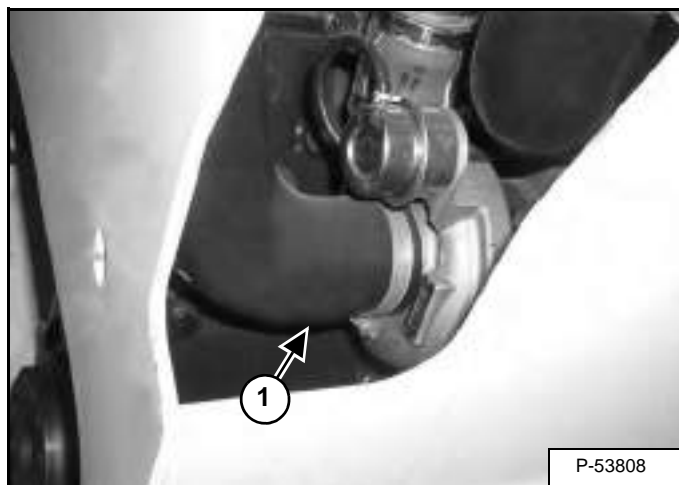

Remove the intake hose (Item 1) [Figure 70-60-4] from the turbo.

Figure 70-60-5

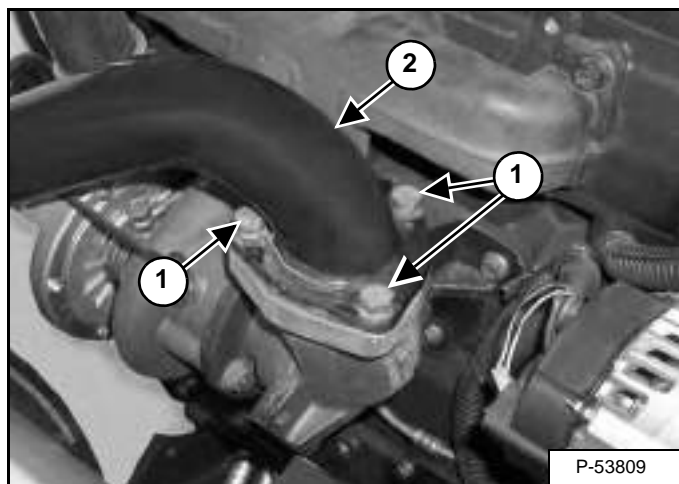

Remove the three bolts (Item 1) and exhaust tube (Item 2) [Figure 70-60-5].

Figure 70-60-6

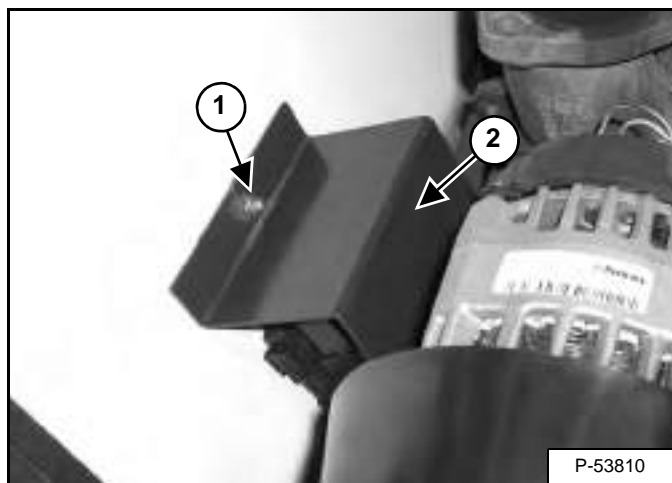

Remove the bolt and nut (Item 1) at the rear of the engine compartment and remove the access panel (Item 2) [Figure 70-60-6].

Figure 70-60-7

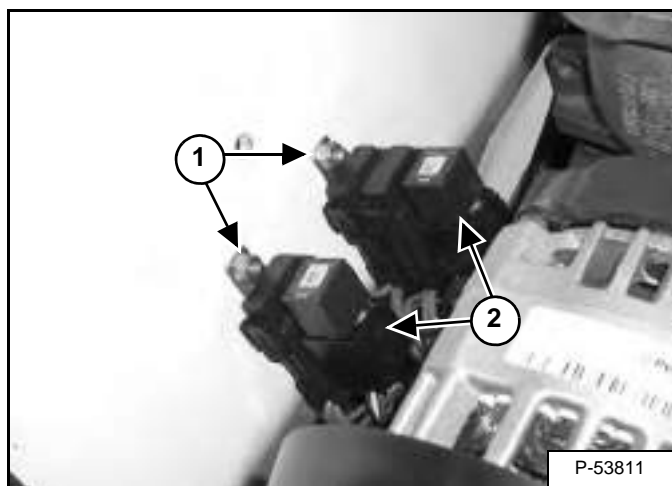

Remove the two bolts (Item 1) and remove the two fuse assemblies (Item 2) [Figure 70-60-7].

## ENGINE AND ENGINE MOUNTS (CONT'D)

### Removal And Installation (Cont'd)

Figure 70-60-8



Reposition the electrical harness [Figure 70-60-8] (as shown).

Figure 70-60-9

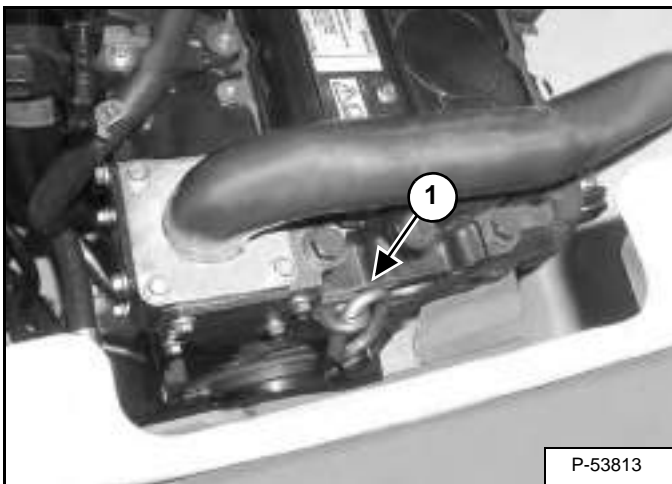

Install a lifting bracket (Item 1) [Figure 70-60-9] in the position shown.

Figure 70-60-10

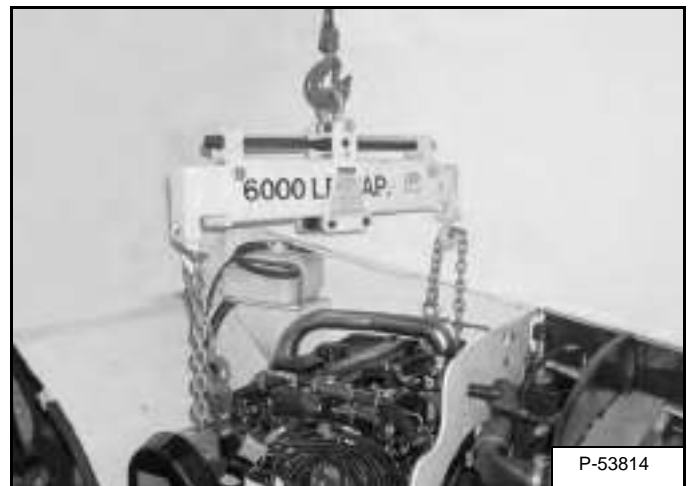

Install a hoist and chain to the lifting brackets [Figure 70-60-10] (as shown).

Figure 70-60-11

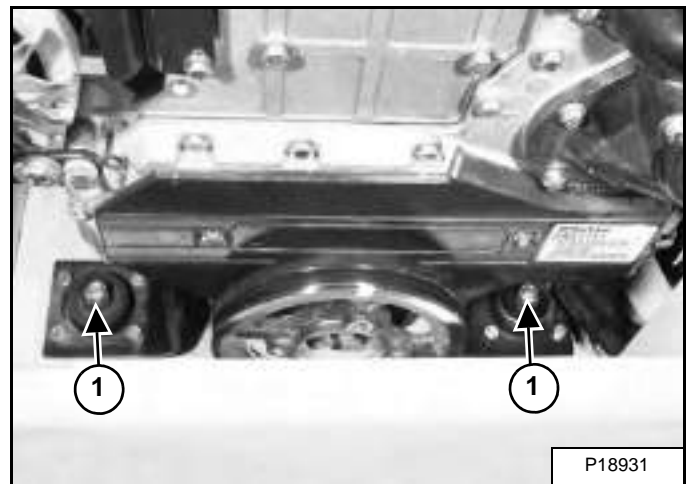

Remove both front engine mount bolts (Item 1) [Figure 70-60-11].

**Installation:** Tighten the engine mount bolts to 185-200 ft.-lb. (250-271 N•m) torque.

---

## ENGINE AND ENGINE MOUNTS (CONT'D)

### Removal And Installation (Cont'd)

Figure 70-60-12



Lift and remove the engine [Figure 70-60-12]



## ENGINE COMPONENTS AND TESTING

### Fuel Injection Pump Removal

**NOTE:** Read and fully understand the following procedure before removing the fuel injection pump. Failure to remove the pump correctly will result in incorrect pump timing and the pump will have to be sent to an authorized Delphi dealer to be retimed. The internal adjustment for pump timing is tamper proof. High and low idle adjustments of the fuel injection pump are factory set and adjustments can not be made to the fuel pump.

Set the engine to TDC number one cylinder compression stroke (See "ENGINE TIMING" on page 70-71-1).

**Figure 70-70-1**

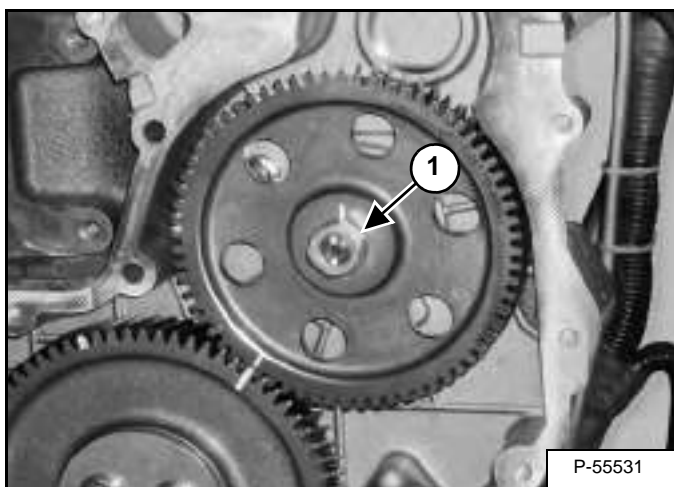

**NOTE:** If the fuel pump nut (Item 1) [Figure 70-70-1] is loosened before the fuel pump timing is set and the pump locked, the fuel pump timing will be lost and the fuel pump will have to be sent into the dealer to be reset.

Apply pressure counterclockwise by hand to the fuel pump gear to remove backlash from the gears.

**Figure 70-70-2**

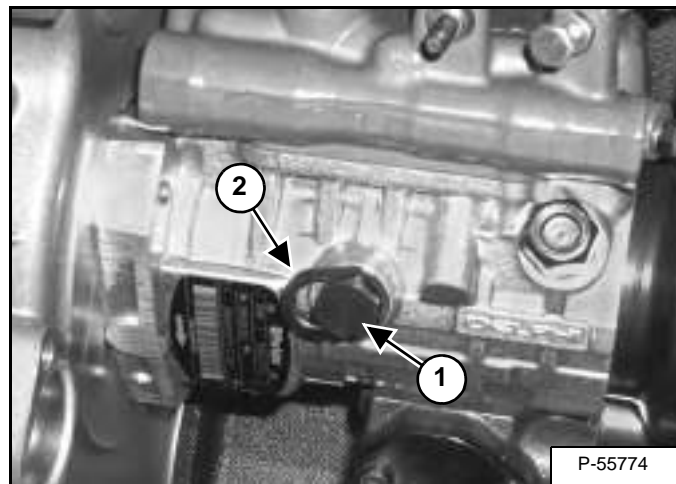

Loosen the lock bolt (Item 1) and move the washer (Item 2) [Figure 70-70-2] to the position shown. Retighten the locking screw to 12 ft.-lb. (17 N•m) torque.

Remove the nut and washer (Item 1) [Figure 70-70-1].

**Figure 70-70-3**

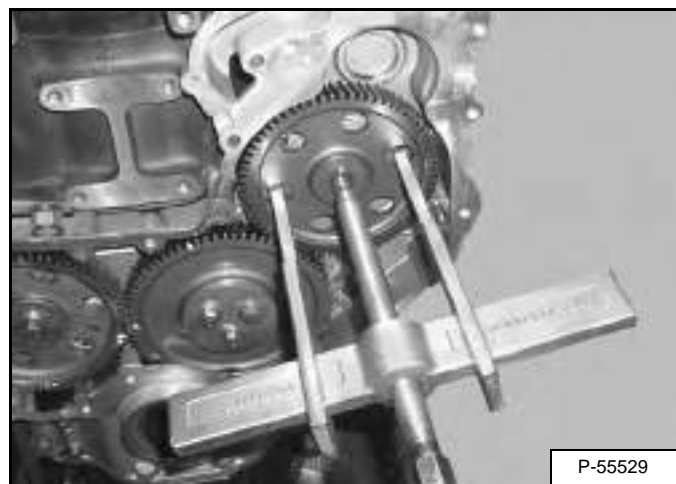

Using a gear puller, remove the fuel pump gear [Figure 70-70-3].

## ENGINE COMPONENTS AND TESTING (CONT'D)

### Fuel Injection Pump Removal (Cont'd)

Figure 70-70-4

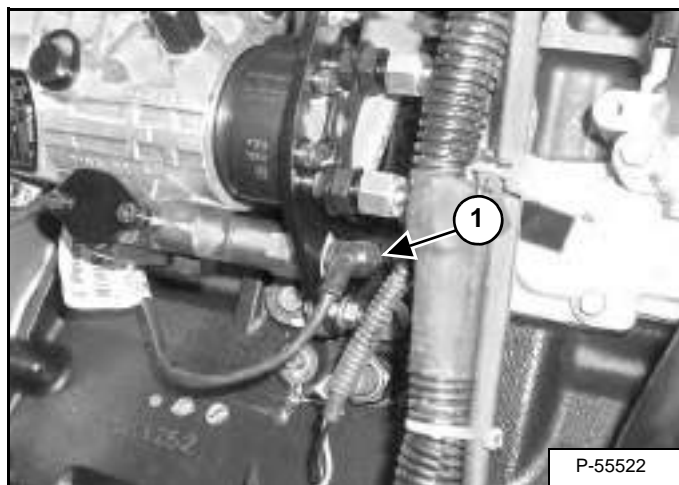

Remove the harness (Item 1) [Figure 70-70-4].

**NOTE:** Mark the connectors for correct installation.

Figure 70-70-5

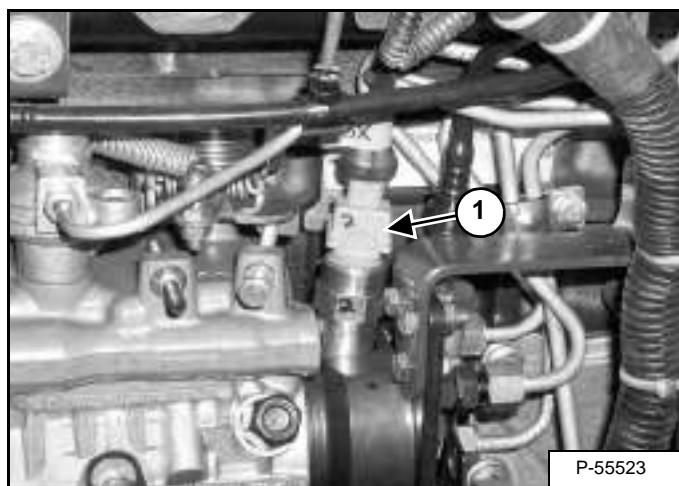

Remove the connector (Item 1) [Figure 70-70-5] from the top of the pump.

Figure 70-70-6

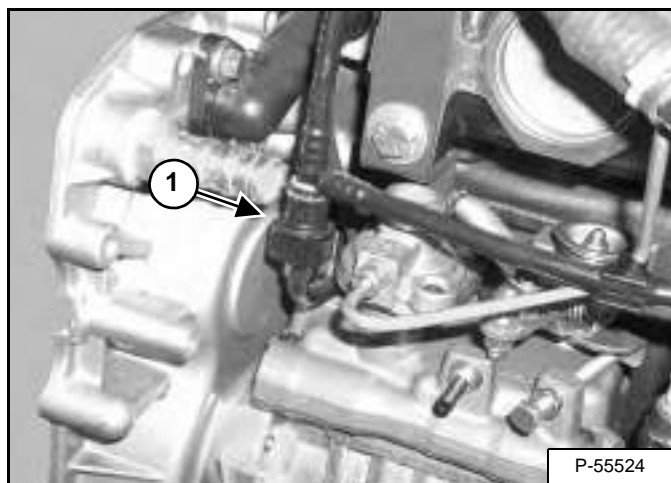

Remove the fuel line (Item 1) [Figure 70-70-6] from the front of the pump.

Figure 70-70-7

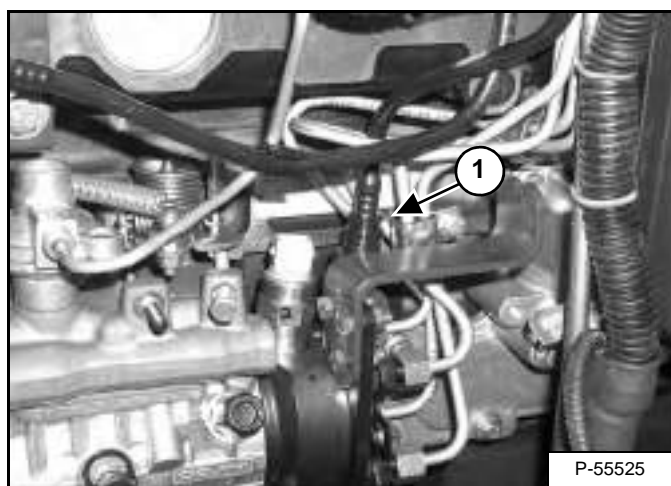

Remove the fuel line (Item 1) [Figure 70-70-7] from the rear of the pump.

## ENGINE COMPONENTS AND TESTING (CONT'D)

### Fuel Injection Pump Removal (Cont'd)

Figure 70-70-8

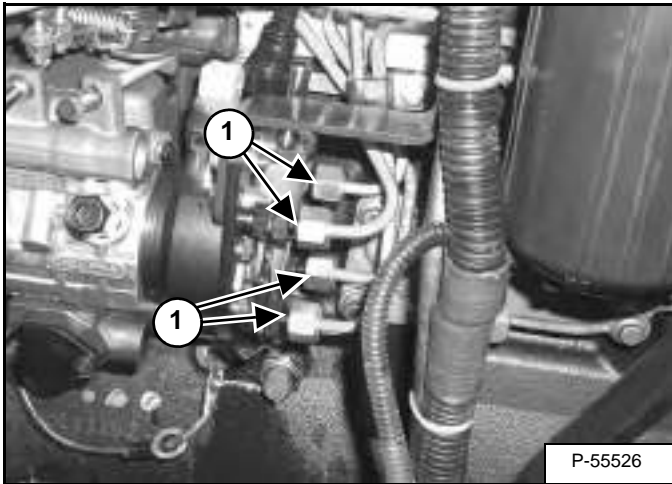

Remove the four fuel tubelines (Item 1) [Figure 70-70-8].

# IMPORTANT

Do not bend the high pressure fuel injection tubes when removing or installing them.

I-2029-0289

Figure 70-70-9

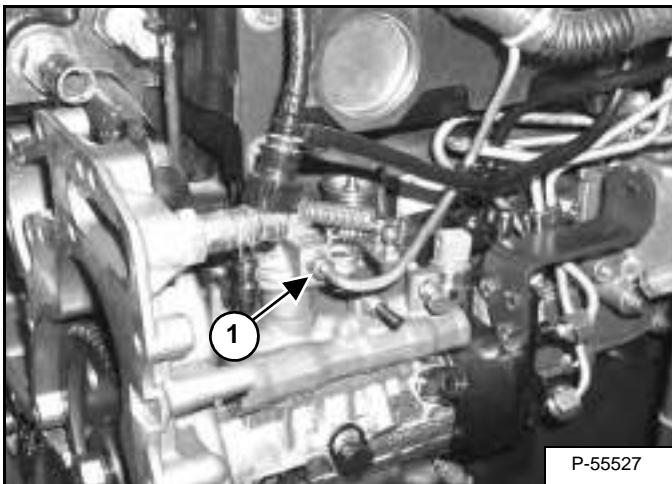

Remove the tubeline (Item 1) [Figure 70-70-9] from the top of the pump.

Figure 70-70-10

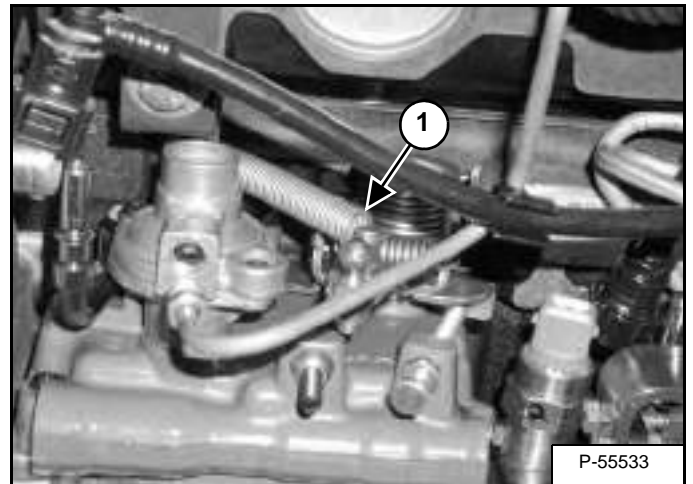

Disconnect the return spring (Item 1) [Figure 70-70-10] from the pump linkage.

Figure 70-70-11

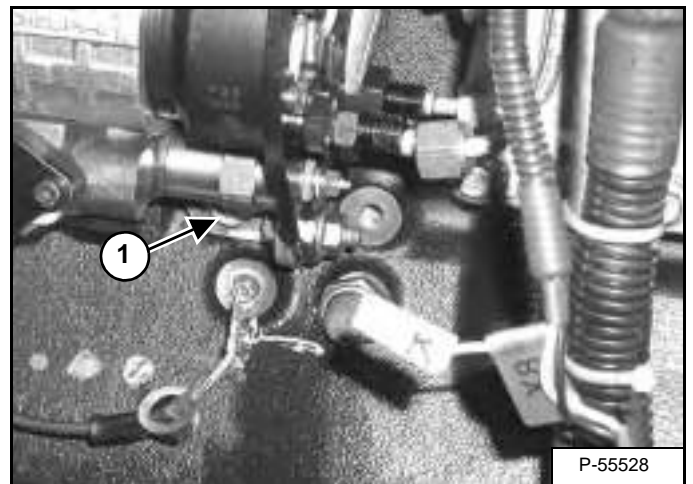

Remove the mount bolt (Item 1) [Figure 70-70-11] from the bracket.

## ENGINE COMPONENTS AND TESTING (CONT'D)

### Fuel Injection Pump Removal (Cont'd)

Figure 70-70-12

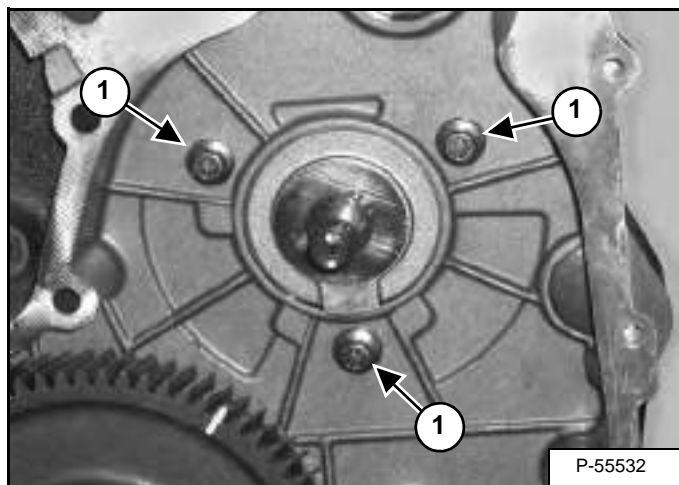

Remove the three mount bolts (Item 1) [Figure 70-70-12] and remove the pump.

### Fuel Injection Pump Installation

The engine must be set to TDC number one cylinder, compression stroke before the pump is fitted (See "ENGINE TIMING" on page 70-71-1).

**NOTE:** The new fuel pump will be supplied with the pump shaft in the locked position. Do not unlock the shaft of the fuel pump until the fuel pump gear is fitted.

Install a new O-ring onto the pump flange.

Figure 70-70-13

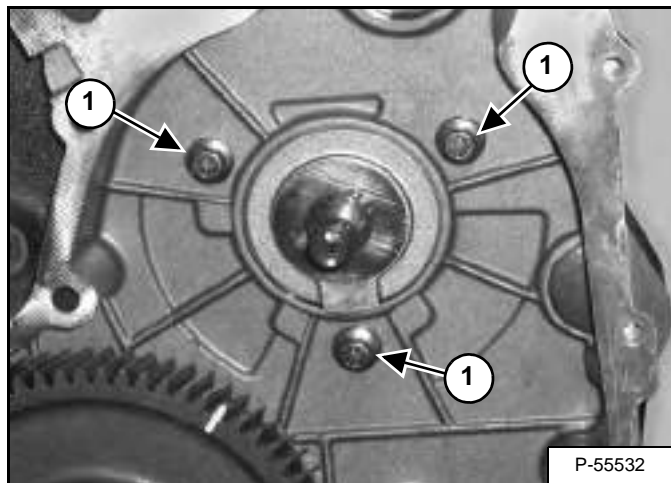

Install the fuel pump and tighten the three bolts (Item 1) [Figure 70-70-13] to 18 ft.-lb. (25 N•m) torque.

Figure 70-70-14

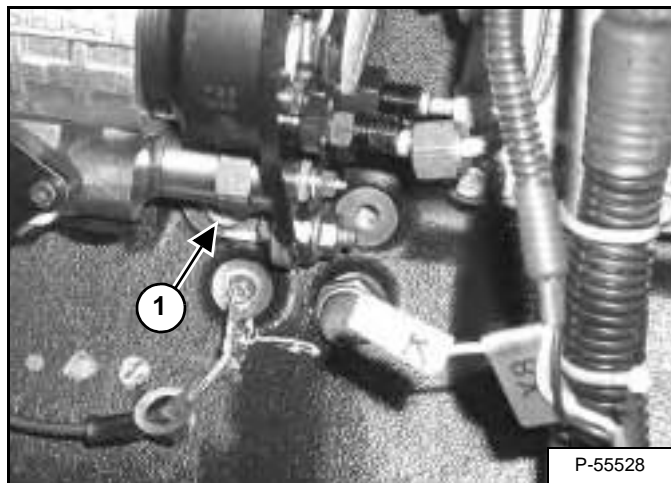

Install the mount bolt (Item 1) [Figure 70-70-14]. Do not tighten at this time.

## ENGINE COMPONENTS AND TESTING (CONT'D)

### Fuel Injection Pump Installation (Cont'd)

Figure 70-70-15

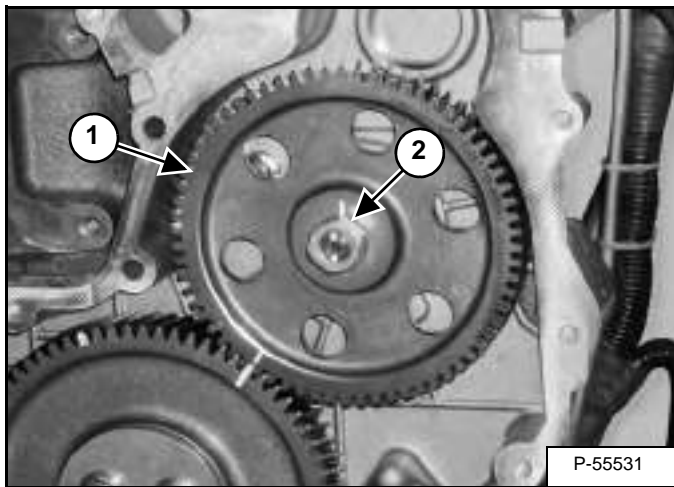

Fit the gear (Item 1) onto the tapered shaft. Make sure the fuel pump gear is correctly in mesh with the idler gear and install the washer and nut (Item 2) [Figure 70-70-15]. Do not tighten at this time.

**NOTE: The backlash must be removed before the fuel injection pump is released. Failure to do so will make the fuel pump timing incorrect.**

Figure 70-70-16

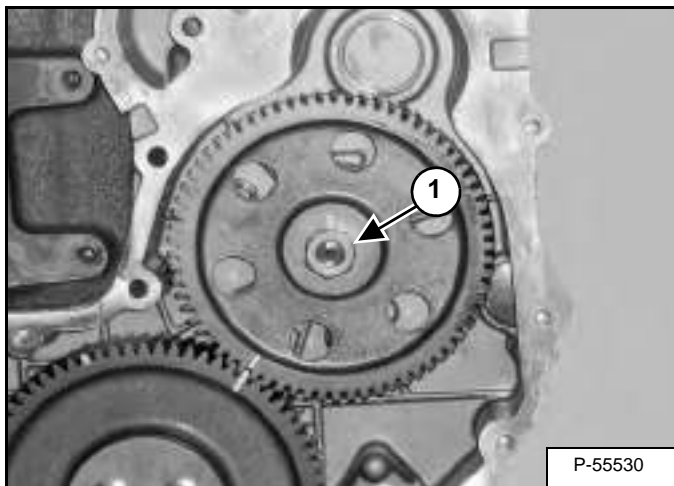

Apply pressure counterclockwise by hand to the fuel pump gear to remove the backlash from all the gears. Tighten the nut (Item 1) [Figure 70-70-16] to 18 ft.-lb. (24 N•m) torque.

Figure 70-70-17

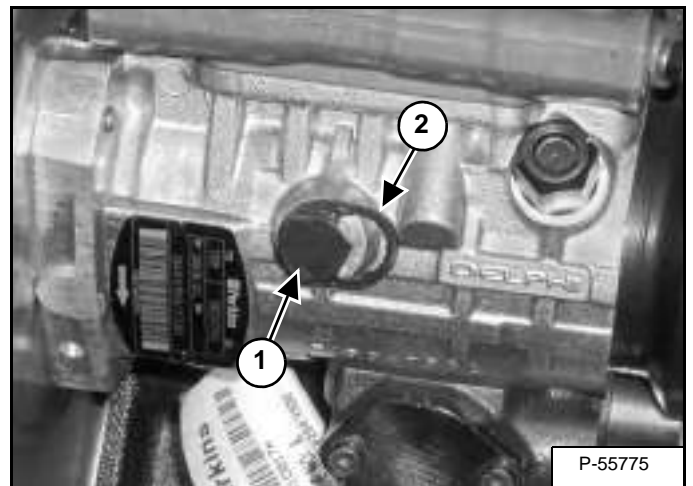

Loosen the locking bolt (Item 1) and move the washer (Item 2) [Figure 70-70-17] to the position shown and tighten the bolt to 9 ft.-lb. (12 N•m) torque.

Retighten the nut (Item 1) [Figure 70-70-16] to 65 ft.-lb. (88 N•m) torque.

Figure 70-70-18

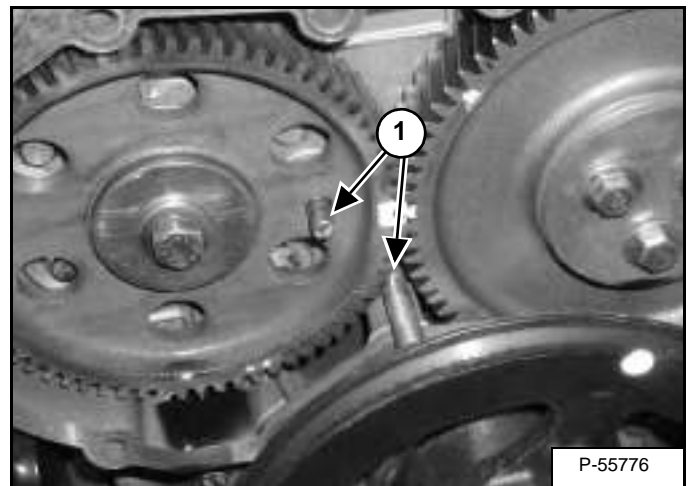

Remove the two timing pins (Item 1) [Figure 70-70-18].

Lightly lubricate each gear with clean engine oil.

Install the timing case cover (See "Timing Cover Installation" on page 70-100-19).

Install the glow plugs (See "Glow Plugs Removal And Installation" on page 70-70-12).

Install the rocker cover (See "Rocker Cover Removal And Installation" on page 70-100-5).

## ENGINE COMPONENTS AND TESTING (CONT'D)

### Fuel Injection Pump Installation (Cont'd)

Figure 70-70-19

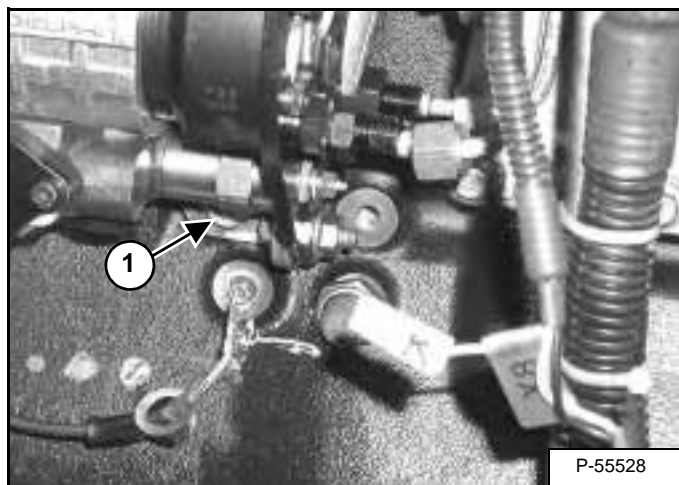

Tighten the mount bolt (Item 1) [Figure 70-70-19] to 32 ft.-lb. (44 N•m) torque.

Figure 70-70-20

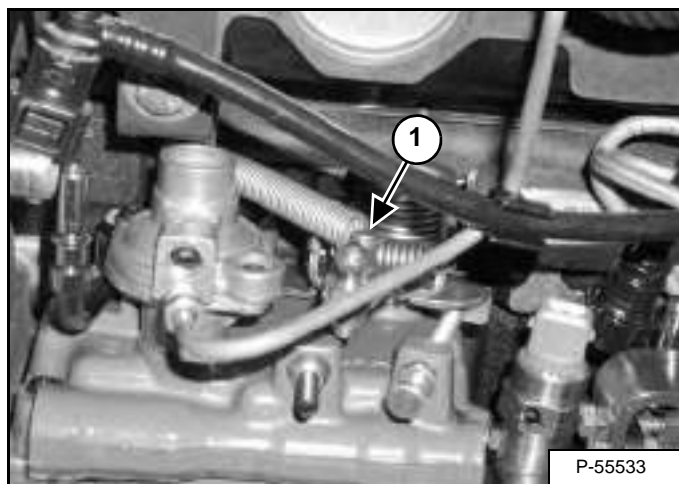

Connect the return spring (Item 1) [Figure 70-70-20] to the pump linkage.

Figure 70-70-21

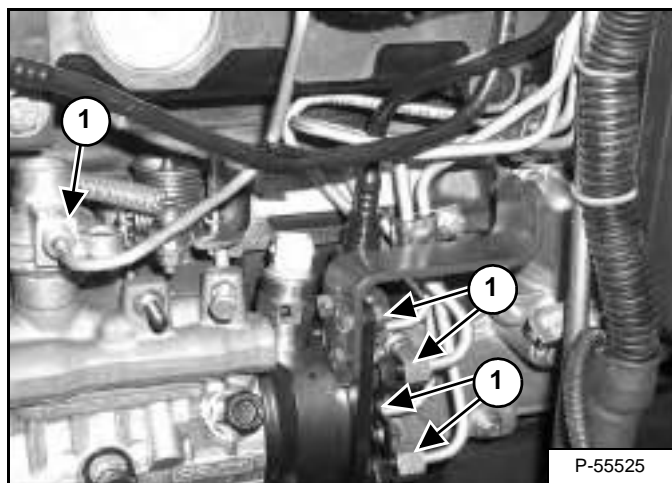

Install the tubelines (Item 1) [Figure 70-70-21] to the pump and tighten to 21 ft.-lb. (27 N•m) torque.

Do not overtighten.

Figure 70-70-22

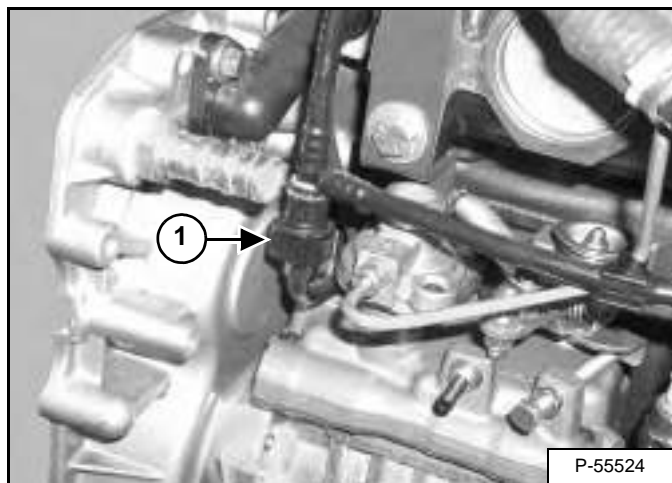



## ENGINE COMPONENTS AND TESTING (CONT'D)

### Fuel Injection Pump Installation (Cont'd)

Figure 70-70-23

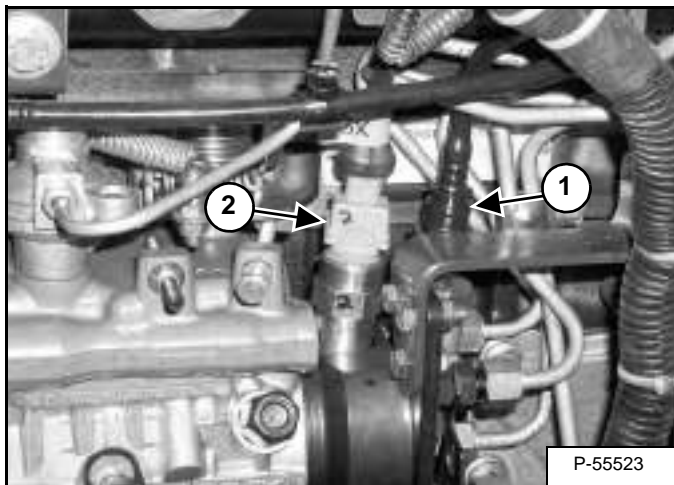

Install the two fuel lines (Item 1) [Figure 70-70-22] & [Figure 70-70-23].

Install the electrical connector (Item 2) [Figure 70-70-23].

Figure 70-70-24

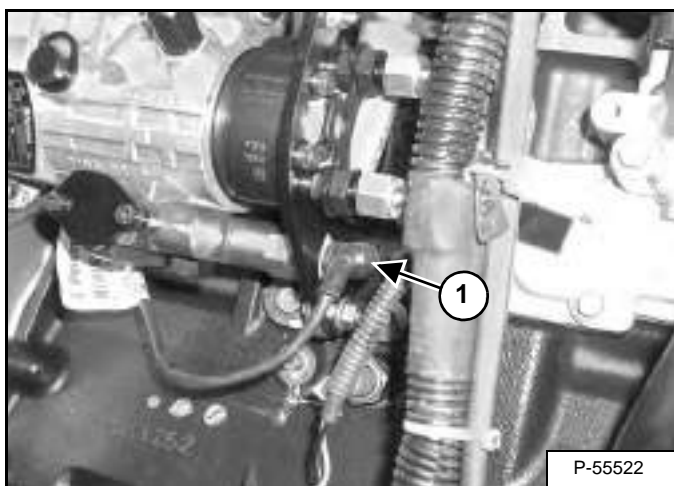

Install the harness (Item 1) [Figure 70-70-24].

Remove air from the system.

## Fuel Injectors Removal And Installation

### **WARNING**

Diesel fuel or hydraulic fluid under pressure can penetrate skin or eyes, causing serious injury or death. Fluid leaks under pressure may not be visible. Use a piece of cardboard or wood to find leaks. Do not use your bare hand. Wear safety goggles. If fluid enters skin or eyes, get immediate medical attention from a physician familiar with this injury.

W-2072-0496

Figure 70-70-25

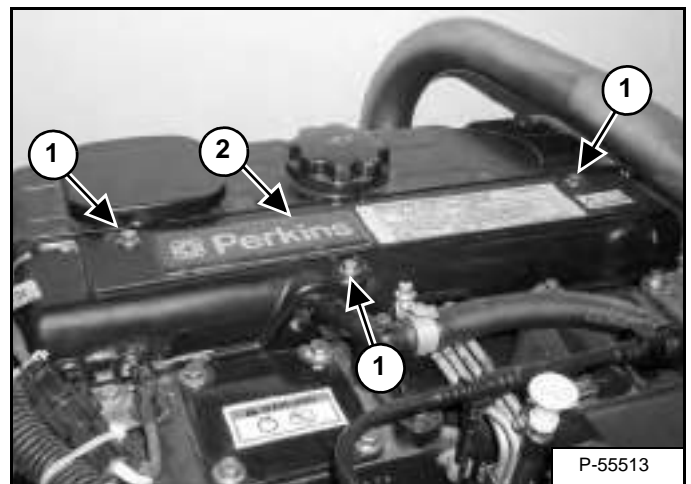

Remove the three bolts (Item 1) and remove the fuel injector cover (Item 2) [Figure 70-70-25].

Figure 70-70-26

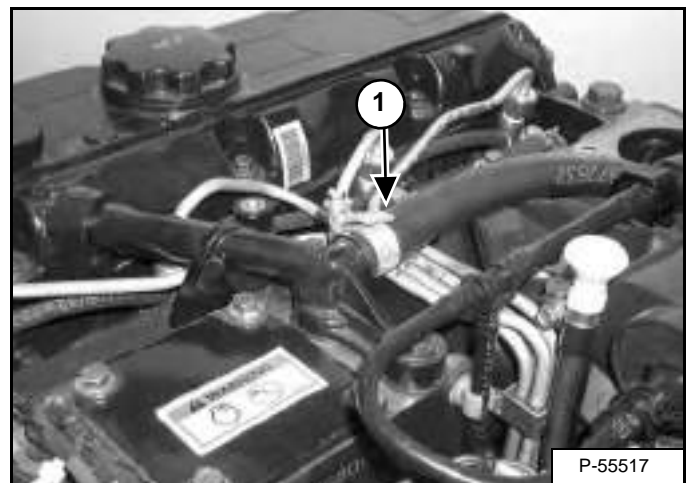

Remove the breather hose (Item 1) [Figure 70-70-26].

## ENGINE COMPONENTS AND TESTING (CONT'D)

### Fuel Injector Removal And Installation (Cont'd)

Figure 70-70-27

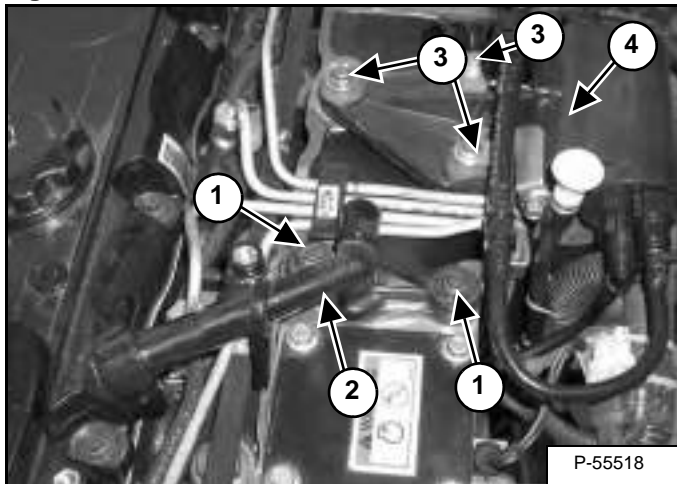

Remove the two bolts (Item 1) and remove the breather fitting (Item 2) [Figure 70-70-27].

Remove the two bolts (Item 3) and remove the fuel filter assembly (Item 4) [Figure 70-70-27].

Figure 70-70-28

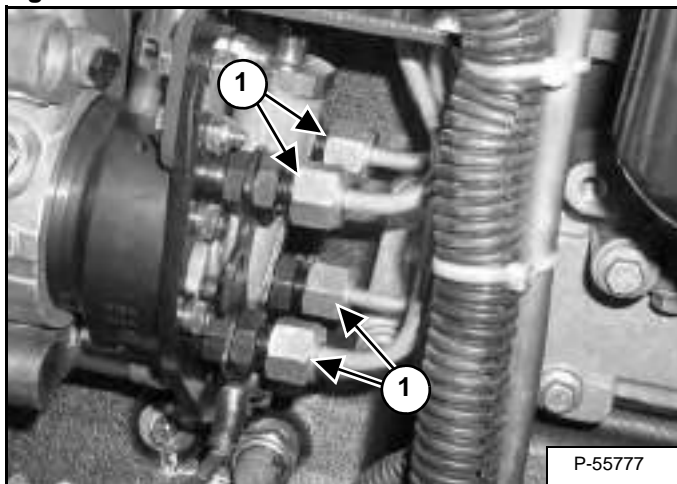

Disconnect the four injector tubelines (Item 1) [Figure 70-70-28] from the injector pump.

**Installation:** Tighten the tubelines to 20 ft.-lb. (27 N•m) torque.

Figure 70-70-29

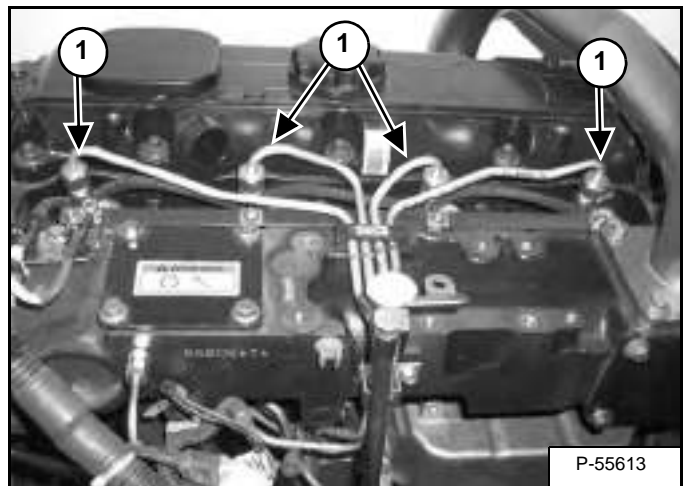

Disconnect the injector tubelines (Item 1) [Figure 70-70-29] from the injectors.

**Installation:** Tighten the tubelines to 20 ft.-lbs. (27 N•m) torque.

Remove the tubelines.

Figure 70-70-30

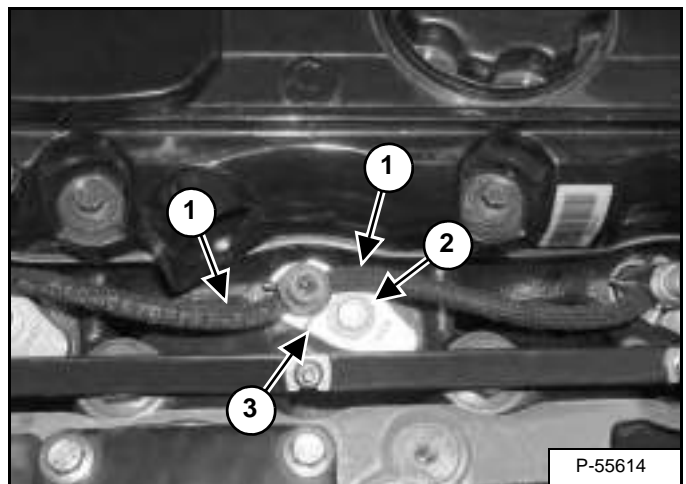

Remove the fuel return hoses (Item 1) and remove the bolt (Item 2) and clamp (Item 3) [Figure 70-70-30].

**Installation:** Tighten bolt to 20 ft.-lb. (27 N•m) torque.

## IMPORTANT

Do not bend the high pressure fuel injection tubes when removing or installing them.

I-2029-0289



## ENGINE COMPONENTS AND TESTING (CONT'D)

### Fuel Injector Removal And Installation (Cont'd)

Figure 70-70-31

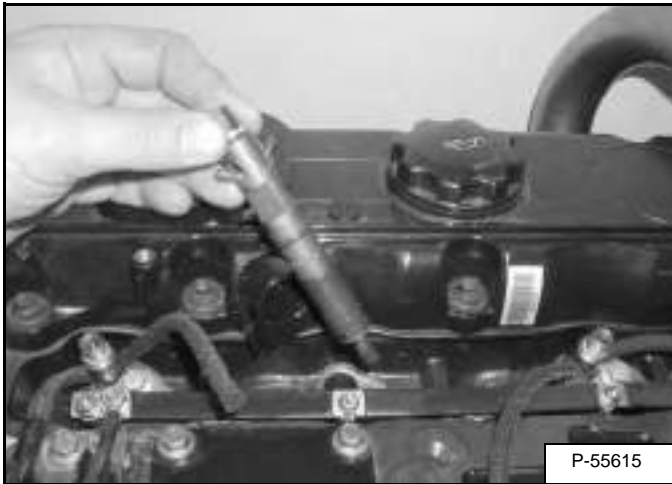

Remove the injector from the cylinder head [Figure 70-70-31].

Figure 70-70-32

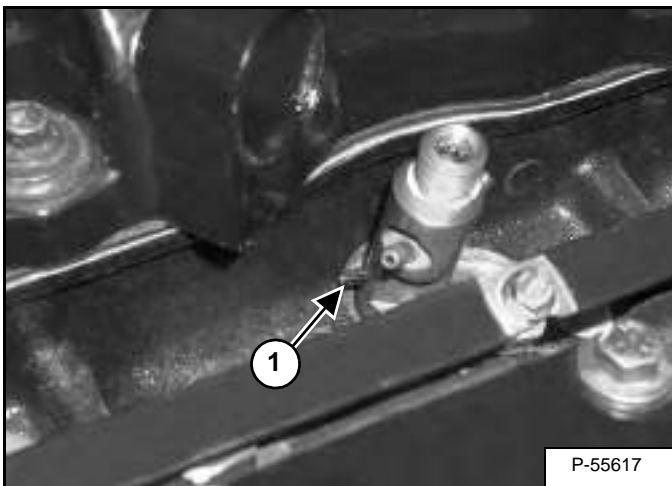

**Installation:** The roll pin must be in the position shown [Figure 70-70-32].

Figure 70-70-33

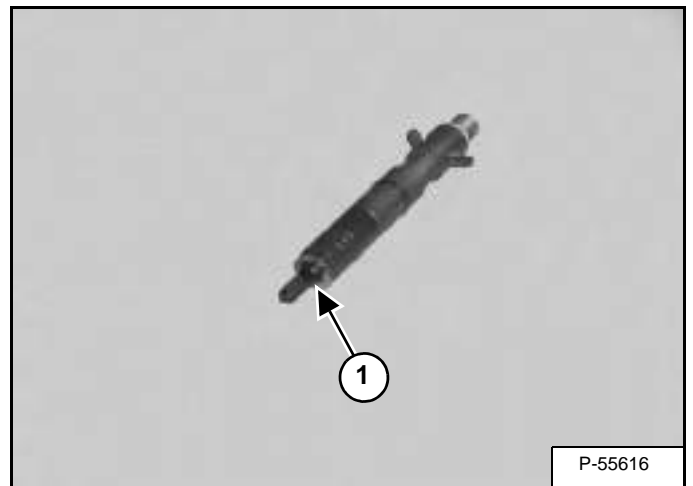

**Installation:** Always replace the copper washer (Item 1) [Figure 70-70-33] at the nozzle. If the washer remains in the cylinder head, it must be removed.

### Checking The Fuel Lift Pump

Figure 70-70-34

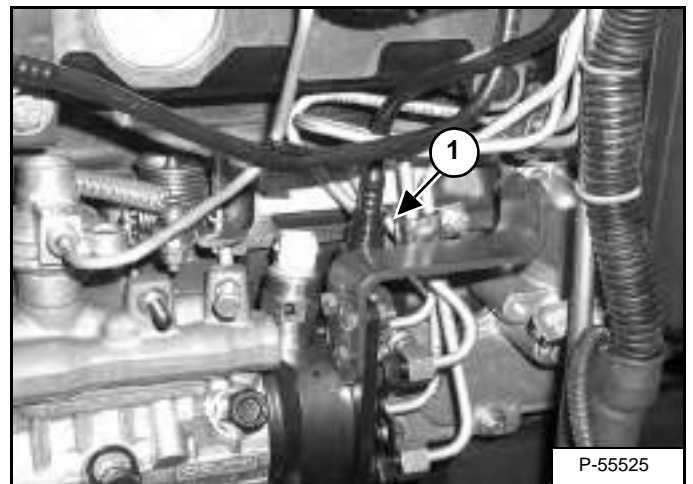

Remove the fuel lift pipe (Item 1) [Figure 70-70-34] from the injector pump, fit a suitable pipe with a pressure test point and connect a pressure gauge.

Operate the engine at idler for two minutes to allow any trapped air to be removed.

Standard pressure should be 4 PSI (.3 Bar).

## ENGINE COMPONENTS AND TESTING (CONT'D)

### Fuel Lift Pump Removal And Installation

Figure 70-70-35

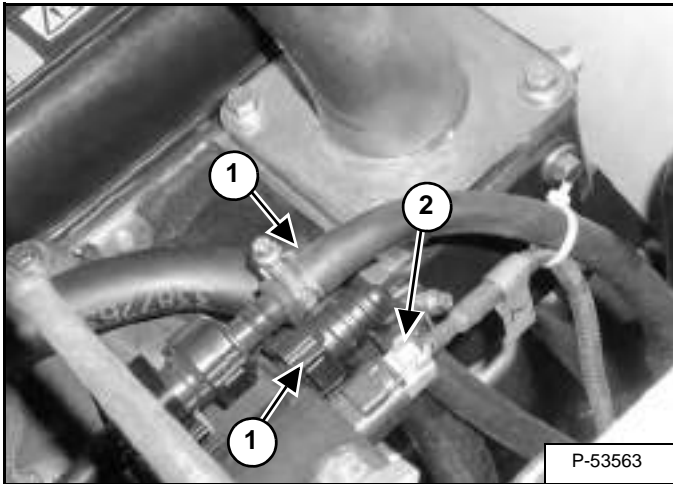

Remove the two fuel lines (Item 1) and electrical harness (Item 2) [Figure 70-70-35] from the fuel lift pump/filter assembly.

Figure 70-70-36

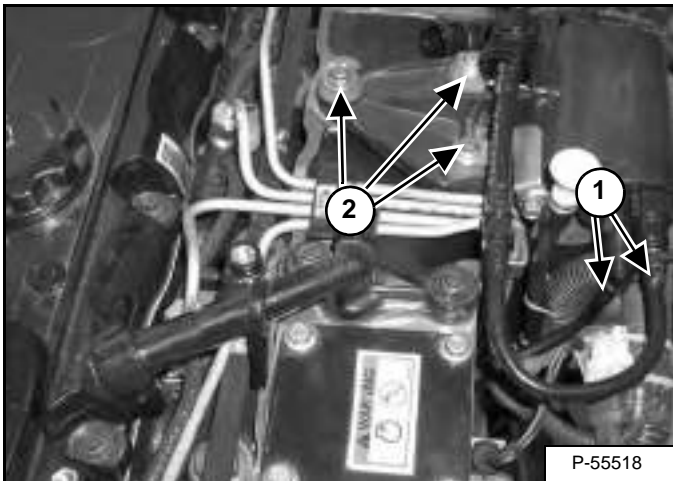

Remove the two fuel lines (Item 1) and three bolts (Item 2) [Figure 70-70-36] and remove the fuel lift pump / filter assembly.

### Compression Checking

The tools listed will be needed to do the following procedure:

MEL10630 - Engine Compression Kit  
MEL1352 - Compression Adapter

The engine must be at operating temperature.

Remove the glow plugs (See "Glow Plugs Removal And Installation" on page 70-70-12).

Figure 70-70-37

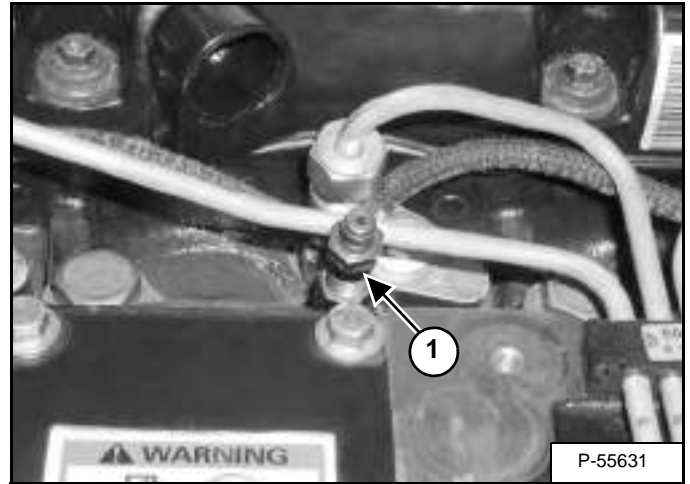

Install the correct compression adapter (Item 1) [Figure 70-70-37] into the cylinder head.

Figure 70-70-38



Connect the compression gauge to the adapter [Figure 70-70-38].

Make sure the engine speed control is fully backward (engine idle).

Disconnect the fuel stop solenoid.

Crank the engine with the starter at 200-300 RPM.

## ENGINE COMPONENTS AND TESTING (CONT'D)

### Compression Checking (Cont'd)

If the measurement is below the allowable limit, check the cylinder, piston ring, top clearance, valve and cylinder head.

Compression Pressure should be 290-570 PSI (20-35 Bar).

Compression tests should only be used to compare between the cylinders of an engine. (If one or more cylinders vary by more than 50 PSI (3.5 Bar) then those cylinders may be faulty.

**Figure 70-70-39**

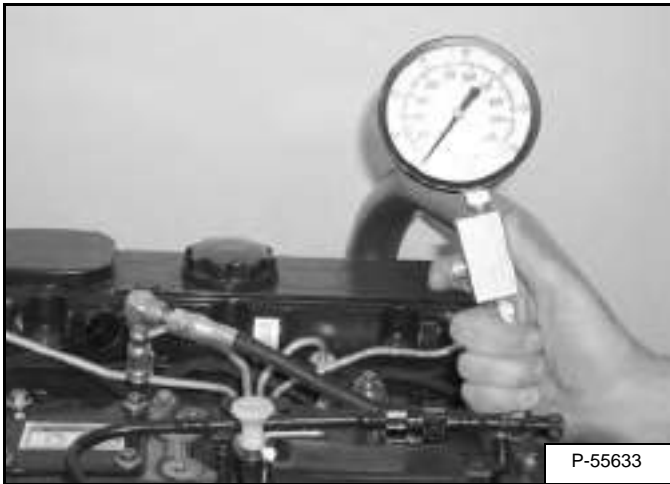

Push the button on the compression gauge to release pressure [Figure 70-70-39].

Connect the fuel stop solenoid.

### Glow Plugs Checking

Disconnect the glow plug cables and leads.

**Figure 70-70-40**

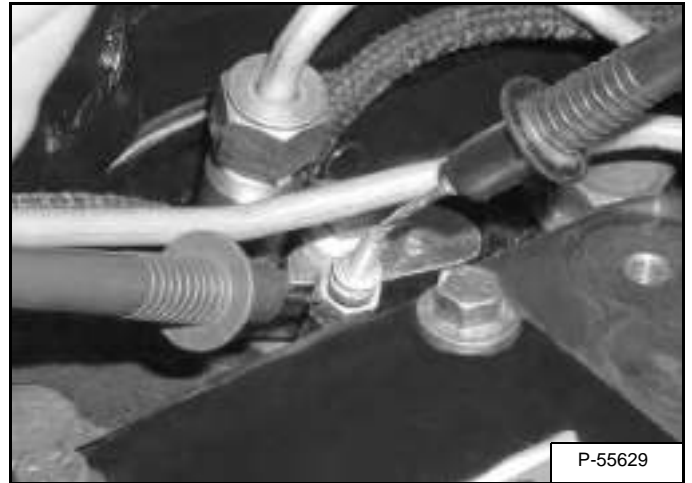

Use an ohmmeter to check the glow plugs [Figure 70-70-40].

**Figure 70-70-41**



Touch one probe to the end of the glow plug and the other probe to the body of glow plug [Figure 70-70-41].

The reading must be between 1 and 2 ohms [Figure 70-70-41]. If the resistance is infinite, the coil of the glow plug is broken.

Repeat the procedure for each glow plug.

## ENGINE COMPONENTS AND TESTING (CONT'D)

### Glow Plugs Removal And Installation

Disconnect the negative (-) cable from the battery.

Figure 70-70-42

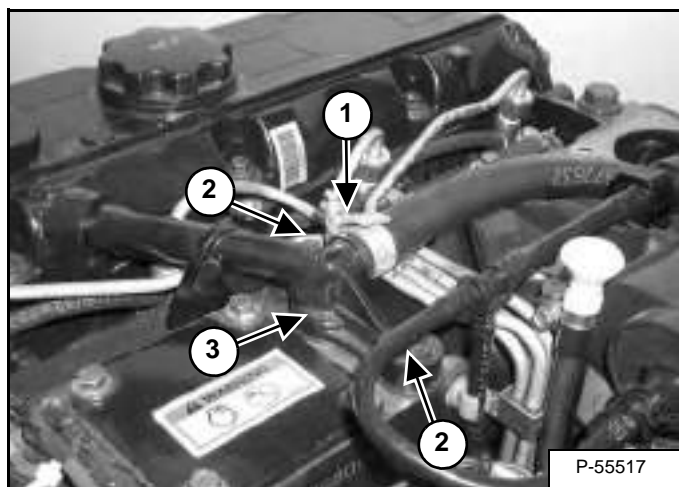

Remove the hose clamp (Item 1), the two bolts (Item 2) and remove the breather (Item 3) [Figure 70-70-42].

Figure 70-70-43

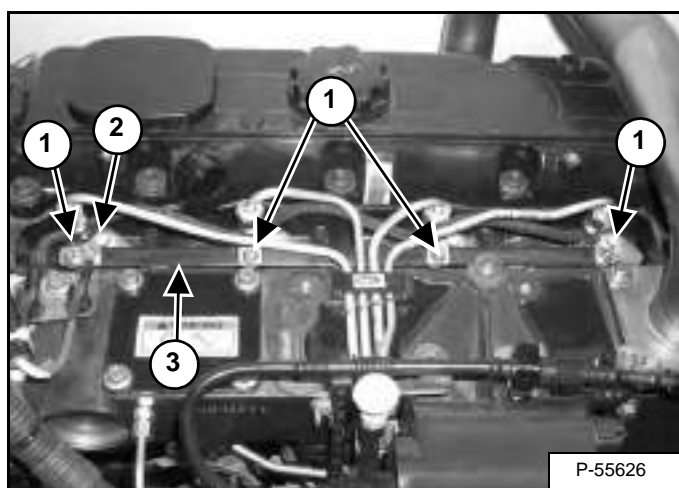

Remove the nut (Item 1) [Figure 70-70-43] from the top of each glow plug.

**Installation:** Tighten to 1.5 ft.-lb. (2 N•m) torque.

Disconnect the engine harness wire (Item 2) [Figure 70-70-43] from the glow plug.

Remove the glow plug connecting strap (Item 3) [Figure 70-70-43].

Figure 70-70-44

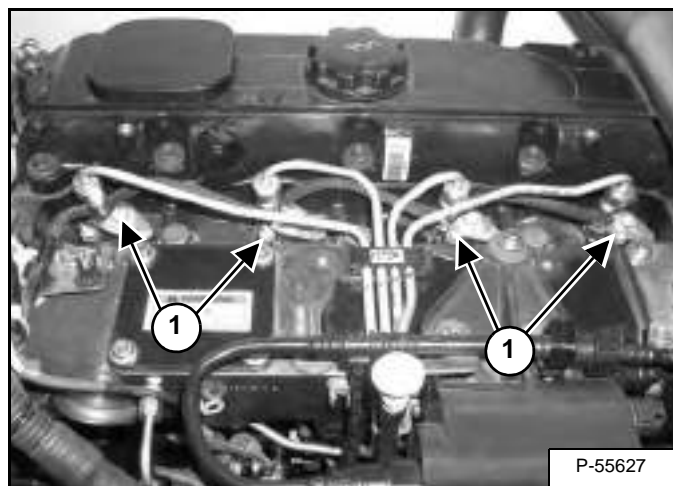

Loosen and remove the glow plugs (Item 1) [Figure 70-70-44].

**Installation:** Tighten the glow plug to 13 ft.-lb. (18 N•m) torque.

## ENGINE TIMING

### Procedure

The tool listed will be needed to do the following procedure:

MEL-1638 Camshaft Timing Pin

MEL-1639 Crankshaft Timing Pin

Remove the rocker cover (See "Rocker Cover Removal And Installation" on page 70-100-5).

Remove the glow plugs (See "Glow Plugs Removal And Installation" on page 70-70-12).

Remove the timing case cover (See "Timing Cover Removal" on page 70-100-19).

**NOTE: The marks on the timing gears are not to be used as timing marks. The marks indicate the front of the gear only.**

Figure 70-71-1

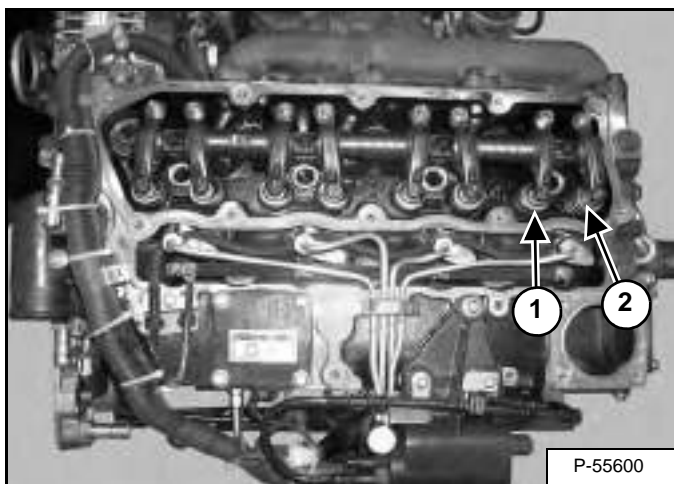

To set the number one piston to TDC on the correct stroke, rotate the crankshaft in the normal direction of rotation until the intake valve (Item 1) of the number four cylinder has just opened and the exhaust valve (Item 2) of the same cylinder has not closed completely.

Figure 70-71-2

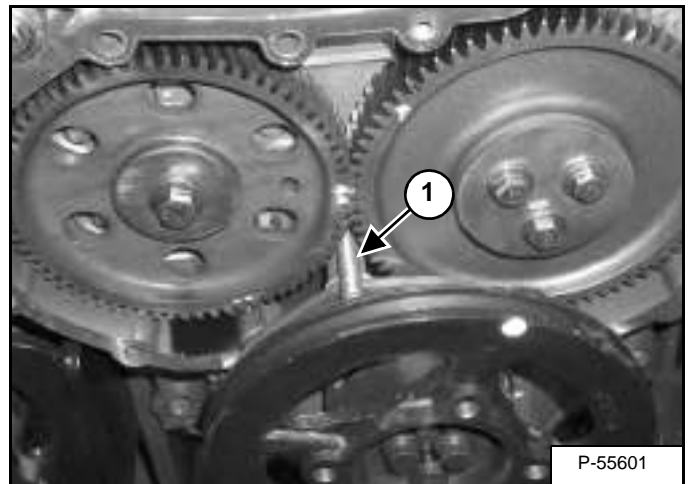

Carefully rotate the crankshaft in the normal direction of rotation. Align the hole in the crankshaft with the hole in the cylinder block and timing case and install the crankshaft timing pin (MEL-1639) (Item 1) [Figure 70-71-2]. Push the pin fully into the hole.

Figure 70-71-3

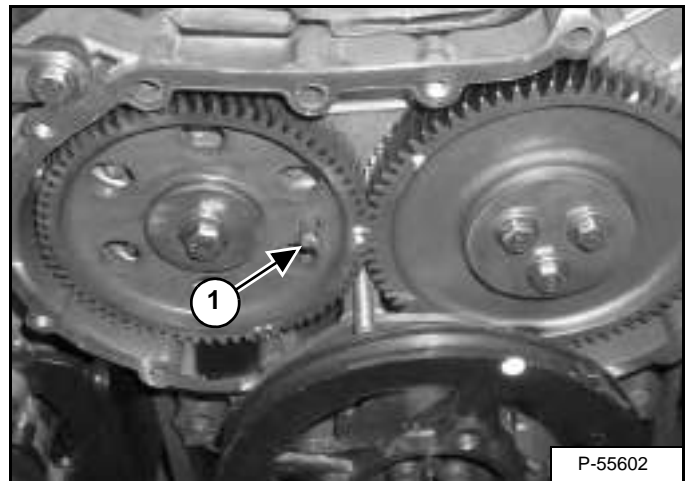

Insert the camshaft timing pin (MEL-1638) (Item 1) [Figure 70-71-3] through the hole in the camshaft gear and into the body of the timing case. With the two pins fitted the engine is set at TDC number one on the compression stroke.

**NOTE: The camshaft timing pin is a push fit into the timing case. The camshaft gear can rotate a small amount when the pin is fitted. This allows the assembly of the gears and removal of the backlash from the gears, with the timing pins fitted.**

Remove the timing pin from each gear.

Install the timing case cover (See "Timing Cover Installation" on page 70-100-19).

Install the glow plugs (See "Glow Plugs Removal And Installation" on page 70-70-12).

Install the rocker cover (See "Rocker Cover Removal And Installation" on page 70-100-5).



**Bobcat®**

## ENGINE / HYDROSTAT ASSEMBLY

### Removal And Installation

Raise the boom and install the boom stop (See "Installing The Approved Boom Stop" on page 10-150-1).

Remove the engine cover (See "Removal And Installation" on page 50-70-1).

Remove the air intake cowling (See "Removal And Installation" on page 50-71-1).

Drain the hydraulic reservoir (See "Replacing Hydraulic Fluid" on page 10-100-2).

Drain the radiator (See "Removal And Installation" on page 70-50-1).

Remove the battery (See "Removal And Installation" on page 60-20-1).

Remove the muffler (See "Removal And Installation" on page 70-30-1).

Remove the drive shaft (See "Removal And Installation" on page 40-70-1).

If equipped with air conditioning, remove the refrigerant from the A/C system (See "Reclamation Procedure" on page 80-100-1).

**Figure 70-80-1**

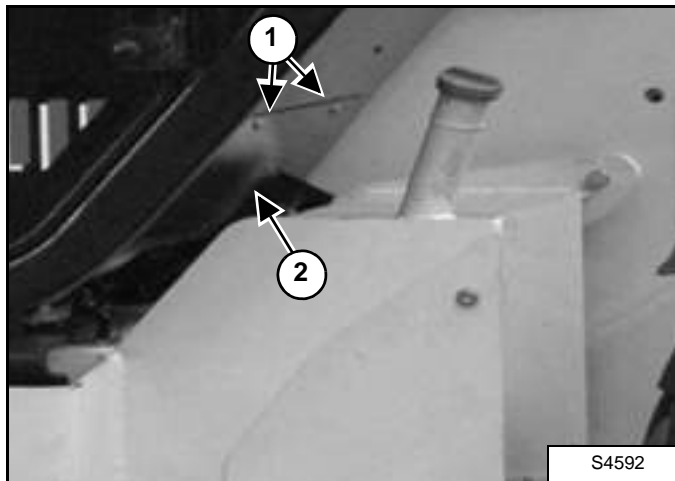

Remove the three screws (Item 1) from the access cover (Item 2) [Figure 70-80-1] located on the back of the canopy.

Remove the access cover.

**NOTE: Mark all hoses and electrical connectors, for correct installation.**

**Figure 70-80-2**

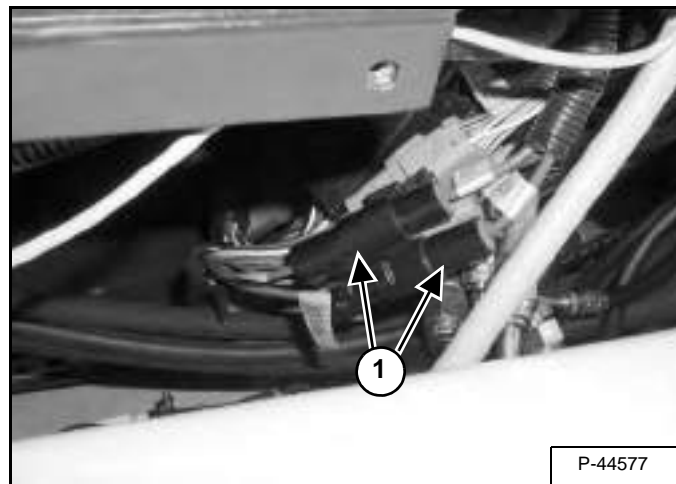

Unplug the two electrical connectors (Item 1) [Figure 70-80-2].

**Figure 70-80-3**

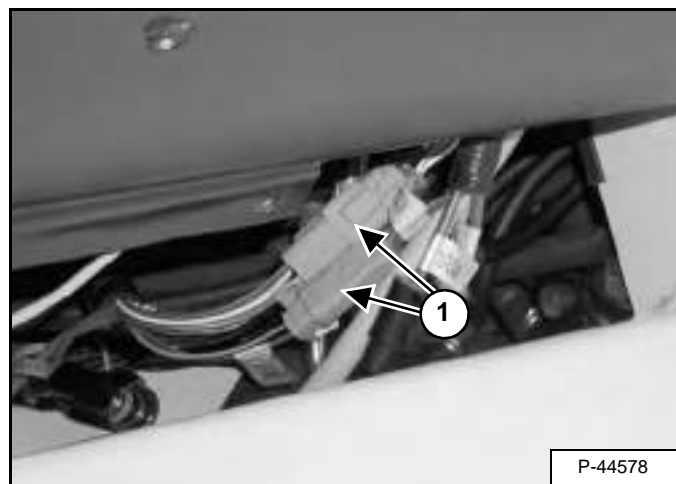

Unplug the two electrical connectors (Item 1) [Figure 70-80-3].

## ENGINE / HYDROSTAT ASSEMBLY (CONT'D)

### Removal And Installation (Cont'd)

Figure 70-80-4

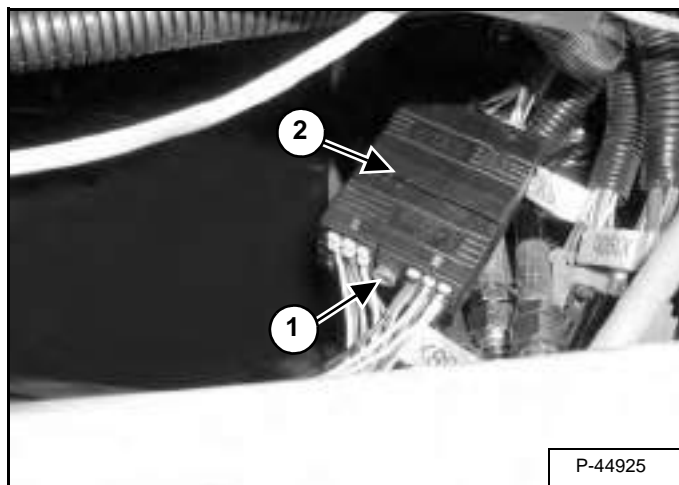

Loosen the screw (Item 1) and unplug the electrical connector (Item 2) [Figure 70-80-4].

Figure 70-80-5

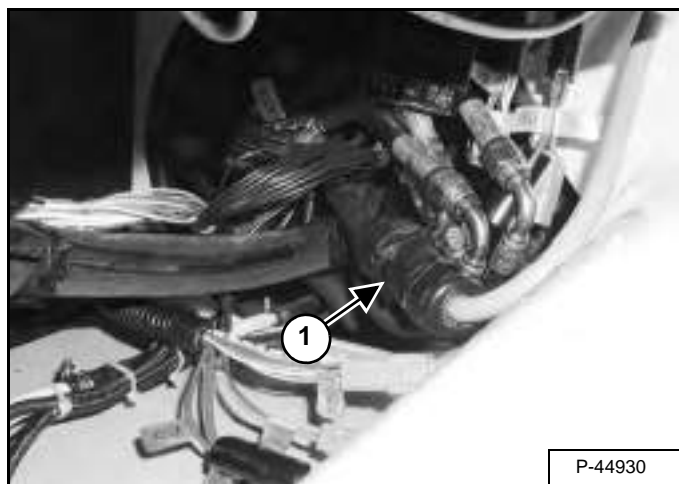

Unplug the electrical connector (Item 1) [Figure 70-80-5].

Figure 70-80-6

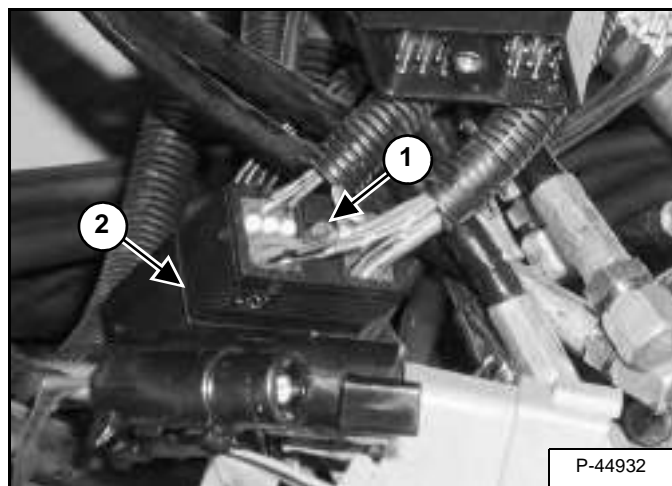

Loosen the screw (Item 1) and unplug the electrical connector (Item 2) [Figure 70-80-6].

Figure 70-80-7

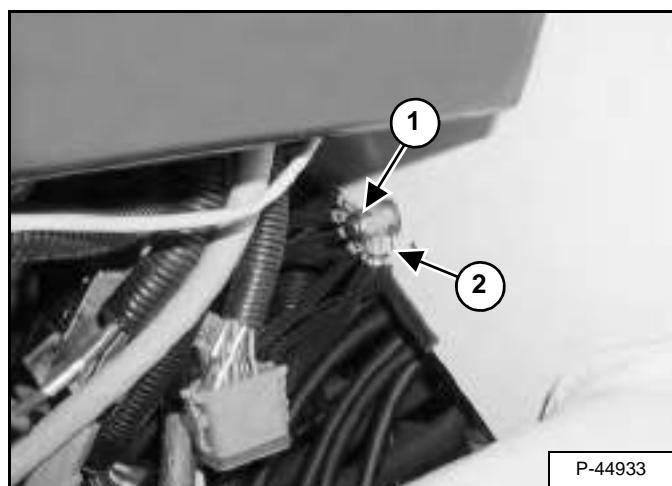

Remove the nut (Item 1) and ground wires (Item 2) [Figure 70-80-7].



## ENGINE / HYDROSTAT ASSEMBLY (CONT'D)

### Removal And Installation (Cont'd)

Figure 70-80-8

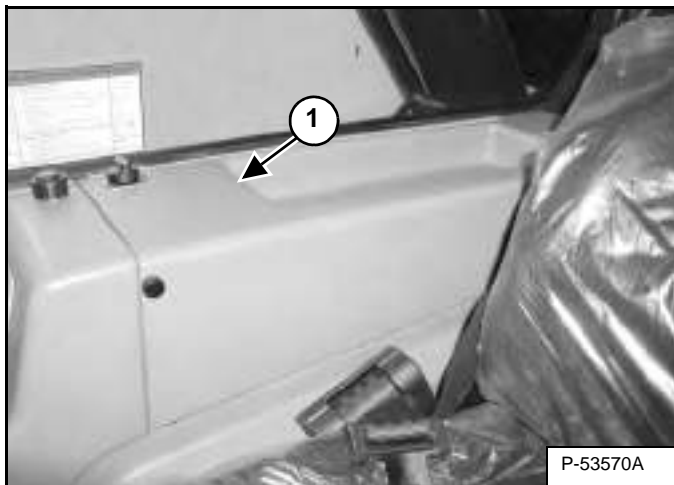

Remove the fuse box cover (Item 1) [Figure 70-80-8].

Figure 70-80-9

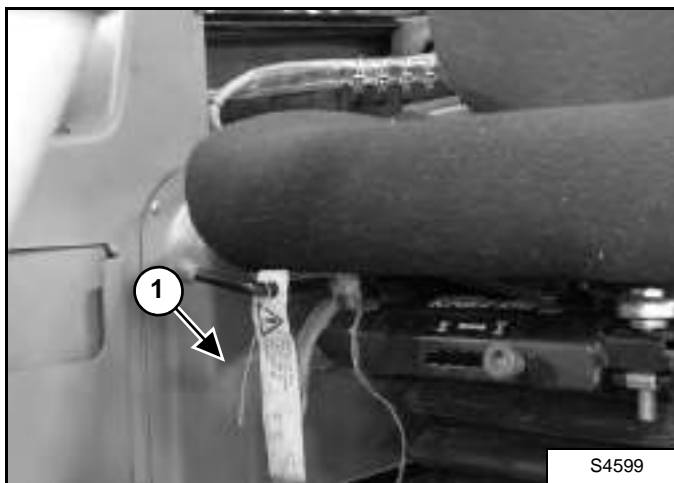

Remove the side cover (Item 1) [Figure 70-80-9].

Figure 70-80-10

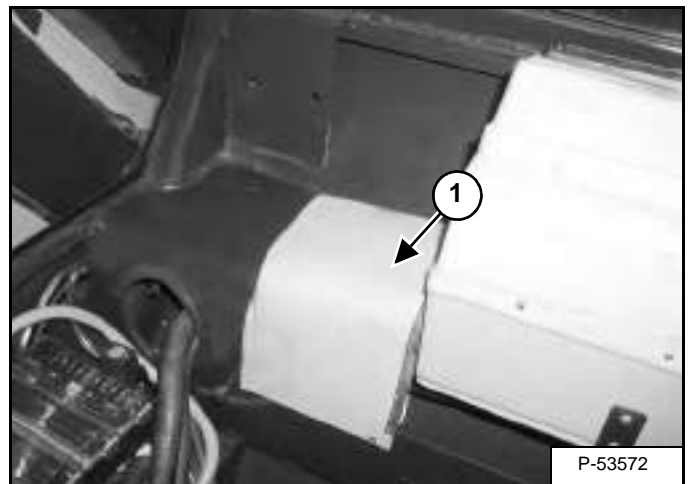

Remove the cover (Item 1) [Figure 70-80-10].

Figure 70-80-11

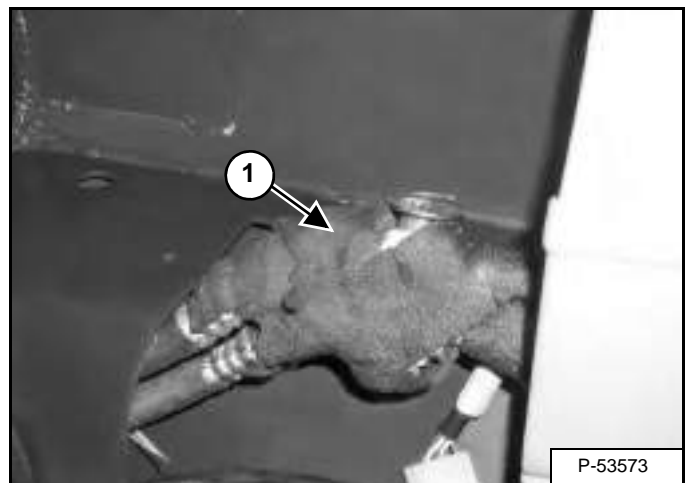

Temporarily remove the protective covering (Item 1) [Figure 70-80-11] from the A/C hoses and expansion valve.

## ENGINE / HYDROSTAT ASSEMBLY (CONT'D)

### Removal And Installation (Cont'd)

Figure 70-80-12

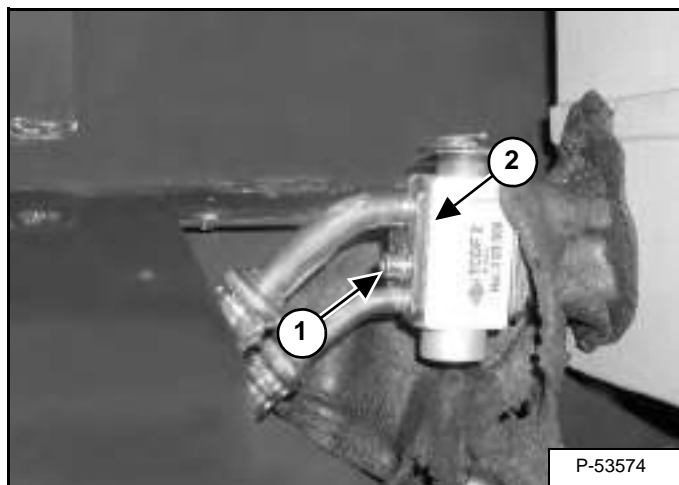

Remove the bolt (Item 1) and plate (Item 2) [Figure 70-80-12]. Remove the A/C hoses.

**NOTE: Plug the A/C hoses to prevent contamination.**

Figure 70-80-13

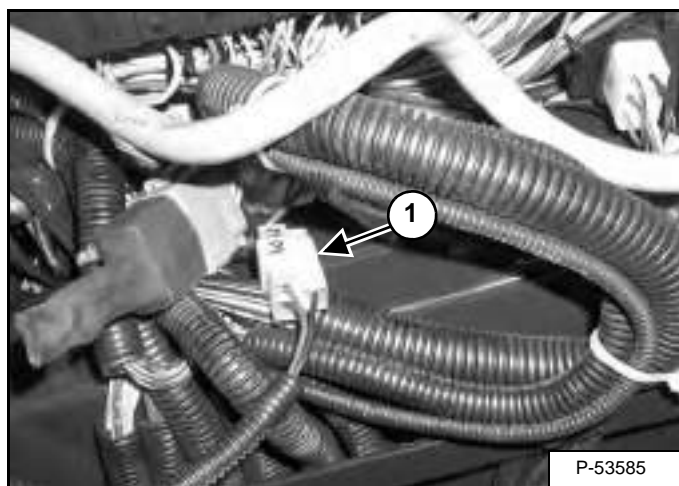

Unplug the connector (Item 1) [Figure 70-80-13] located under the fuse box.

Figure 70-80-14

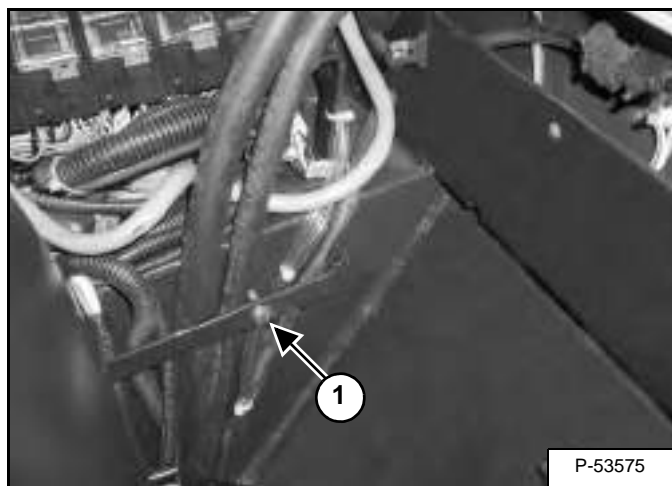

Loosen the mounting bracket bolt (Item 1) [Figure 70-80-14].

Figure 70-80-15

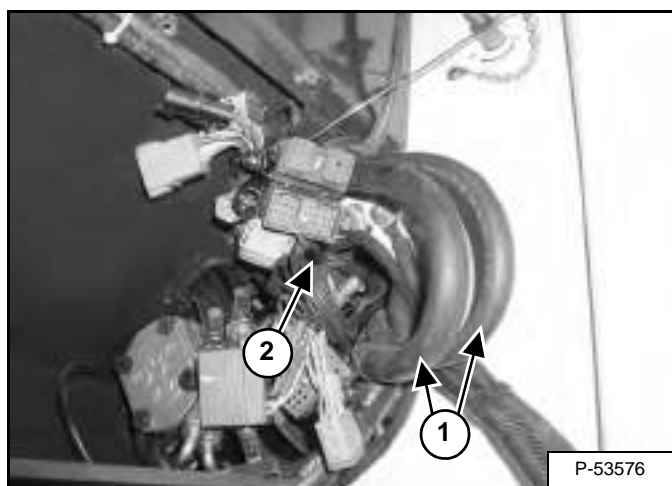

Remove the two A/C hoses (Item 1) and harness (Item 2) [Figure 70-80-15] completely from the rear corner of the cab.

## ENGINE / HYDROSTAT ASSEMBLY (CONT'D)

### Removal And Installation (Cont'd)

Figure 70-80-16

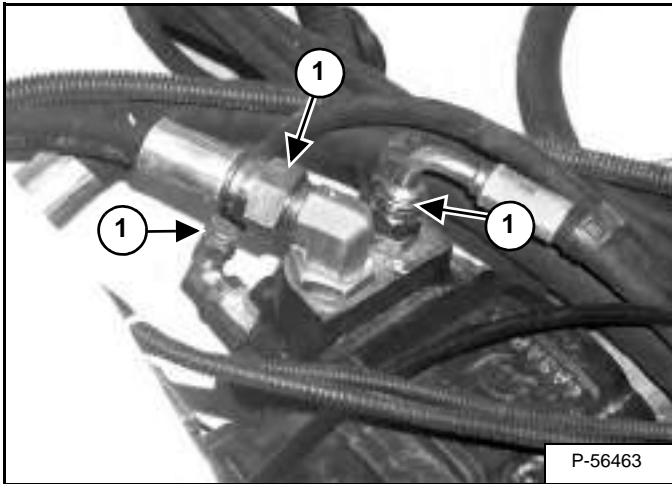

Remove the three hoses (Item 1) [Figure 70-80-16] from the backside of the pump.

Figure 70-80-17

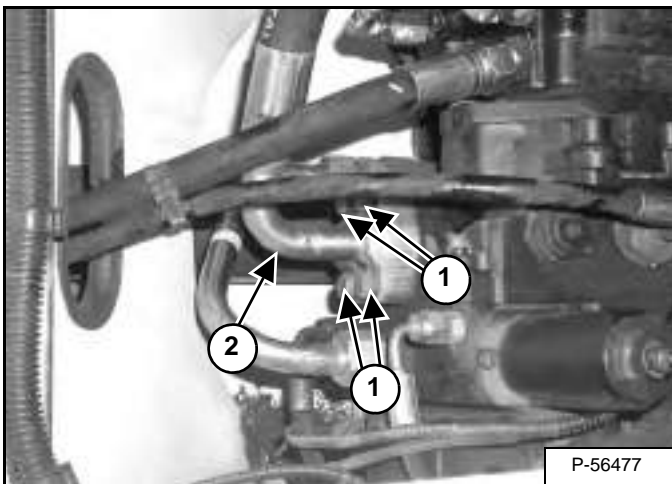

Remove the four bolts (Item 1) and remove the hose (Item 2) [Figure 70-80-17] from the hydrostatic pump.

## WARNING

Hydraulic fluid escaping under pressure can have sufficient force to enter a person's body by penetrating the skin. This can cause serious injury and possible death if proper medical treatment by a physician familiar with this injury is not received immediately.

W-2145-0290

Figure 70-80-18

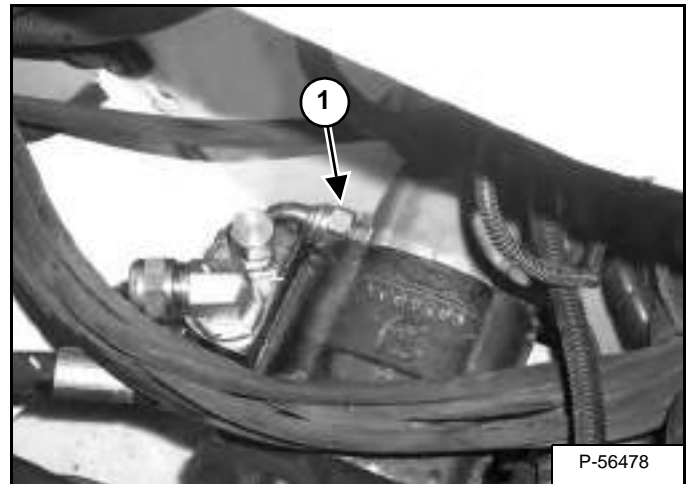

Remove the hose (Item 1) [Figure 70-80-18] from the backside of the pump.

Figure 70-80-19

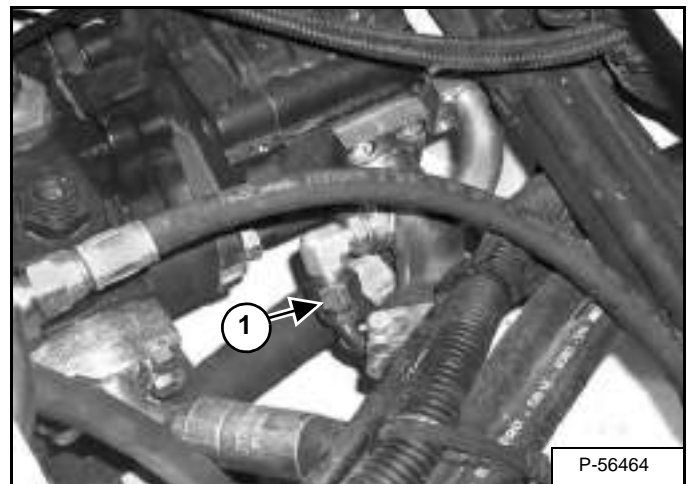

Remove the hose (Item 1) [Figure 70-80-19].

## IMPORTANT

When repairing hydrostatic and hydraulic systems, clean the work area before disassembly and keep all parts clean. Always use caps and plugs on hoses, tubelines and ports to keep dirt out. Dirt can quickly damage the system.

I-2003-0888

## ENGINE / HYDROSTAT ASSEMBLY (CONT'D)

### Removal And Installation (Cont'd)

Figure 70-80-20

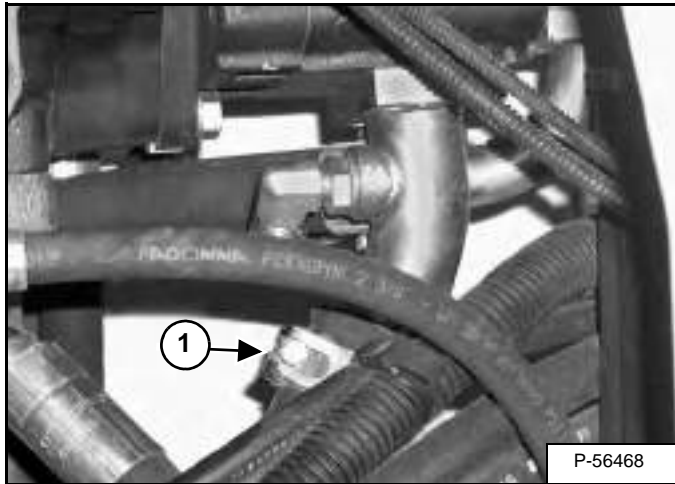

Loosen the hose clamp (Item 1) [Figure 70-80-20] and remove the hose.

Figure 70-80-21

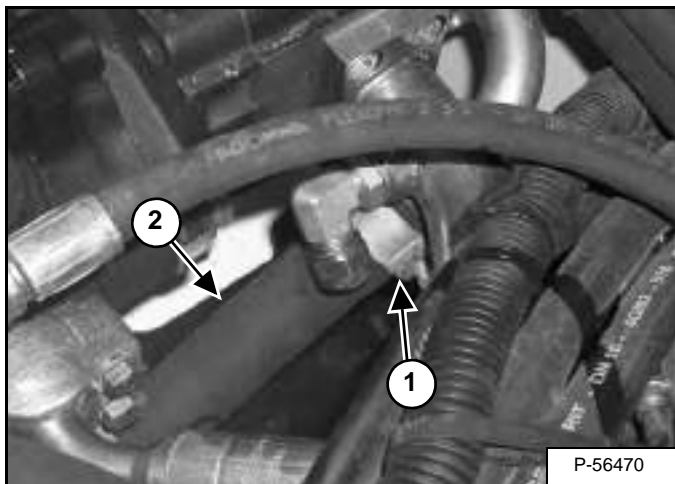

Loosen the hose clamp (Item 1) and remove the hose (Item 2) [Figure 70-80-21].

# IMPORTANT

When repairing hydrostatic and hydraulic systems, clean the work area before disassembly and keep all parts clean. Always use caps and plugs on hoses, tubelines and ports to keep dirt out. Dirt can quickly damage the system.

I-2003-0888

Figure 70-80-22

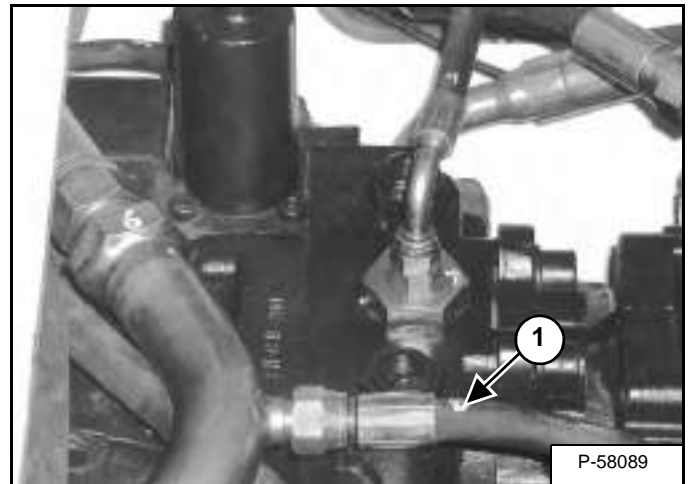

Remove the hose (Item 1) [Figure 70-80-22] from the hydrostatic pump.

Figure 70-80-23

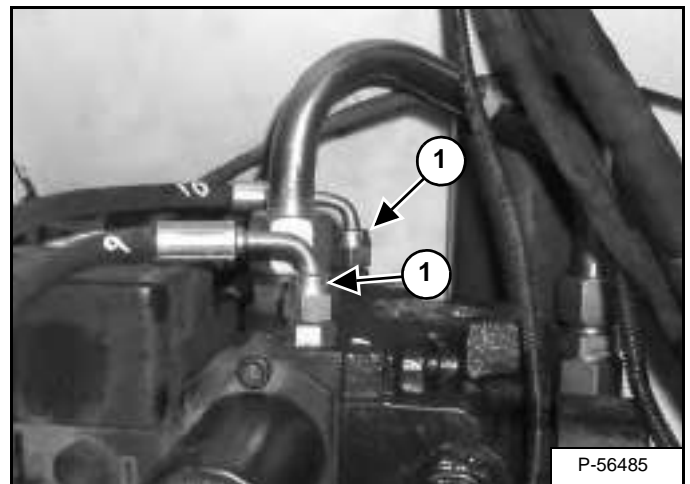

Remove the two hoses (Item 1) [Figure 70-80-23].

## ENGINE / HYDROSTAT ASSEMBLY (CONT'D)

### Removal And Installation (Cont'd)

Figure 70-80-24

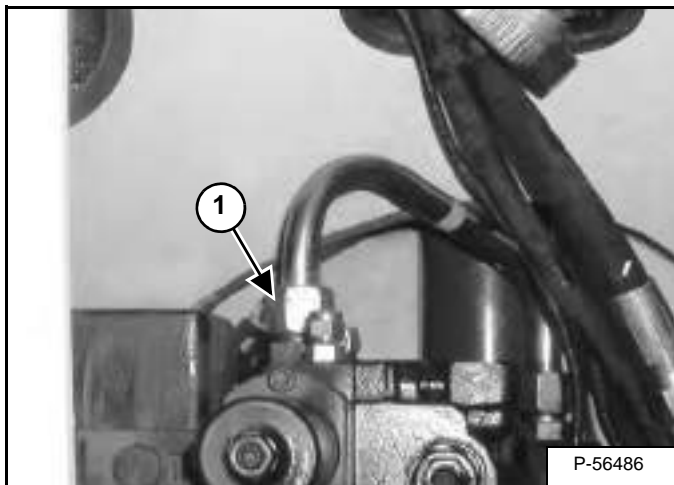

Remove the tubeline (Item 1) [Figure 70-80-24].

Figure 70-80-25

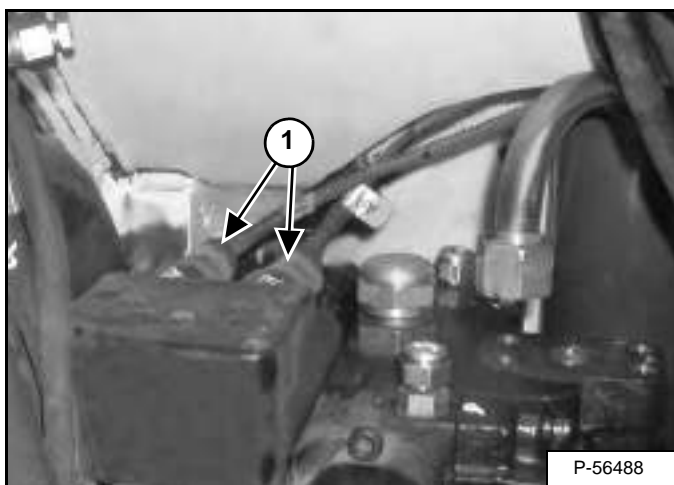

Remove the two wires (Item 1) [Figure 70-80-25] from the solenoids.

Figure 70-80-26

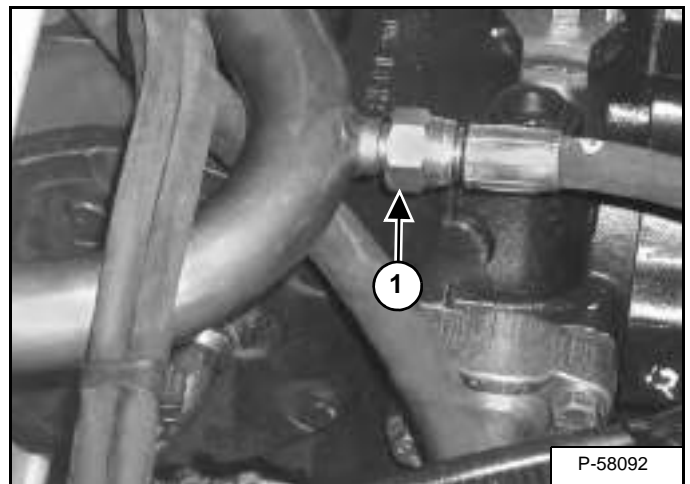

Remove the hose (Item 1) [Figure 70-80-26] from the tubeline.

Figure 70-80-27

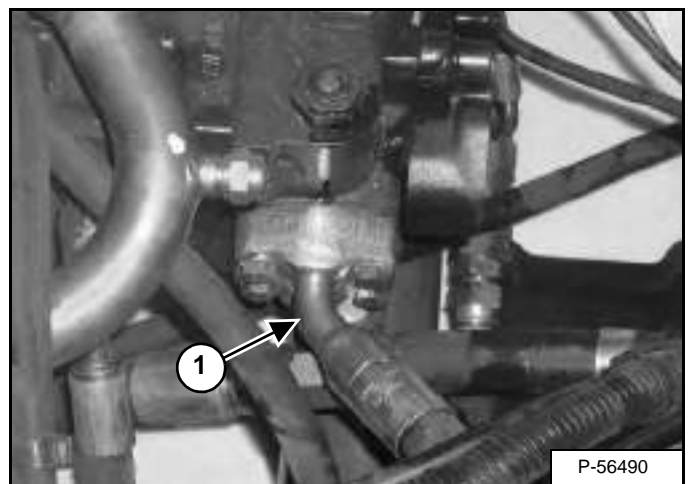

Remove the four bolt flange hose (Item 1) [Figure 70-80-27] from the front of the pump.

## ENGINE / HYDROSTAT ASSEMBLY (CONT'D)

### Removal And Installation (Cont'd)

Figure 70-80-28

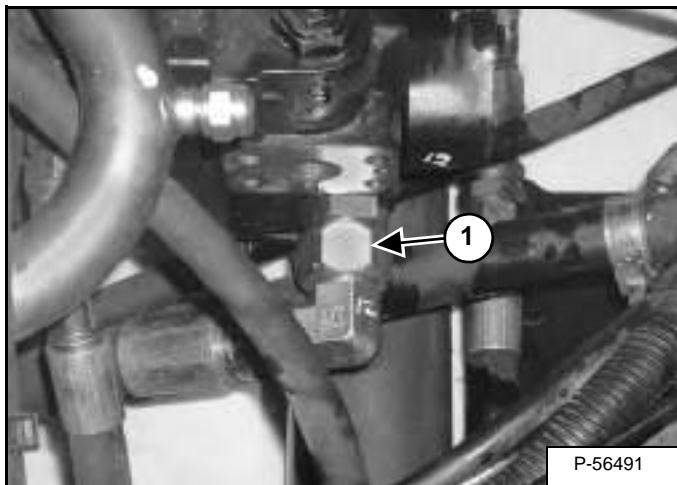

Remove the hose (Item 1) [Figure 70-80-28].

Figure 70-80-29

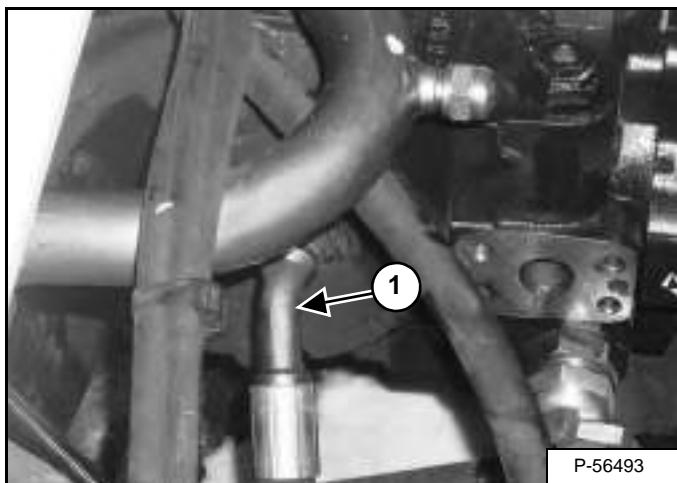

Remove the hose (Item 1) [Figure 70-80-29].

Figure 70-80-30

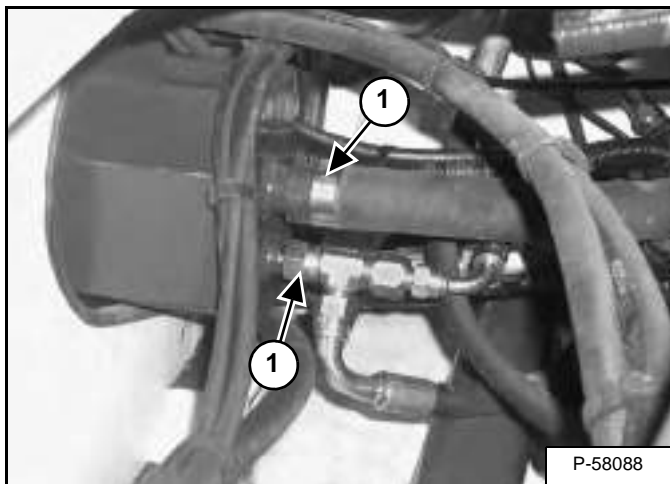

Remove the two hoses (Item 1) [Figure 70-80-30] from the hydraulic reservoir.

Figure 70-80-31

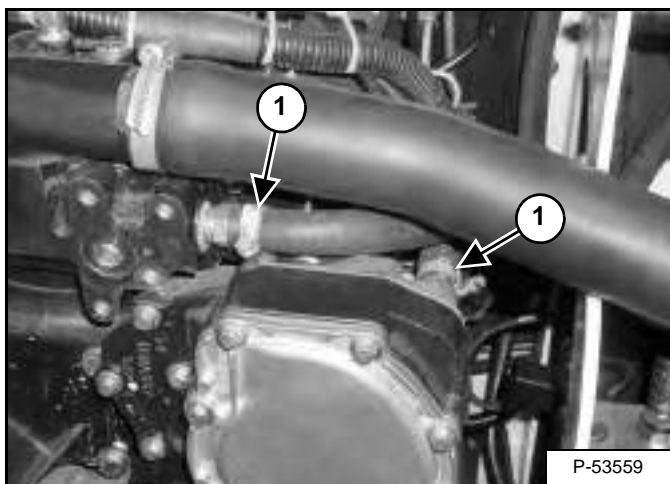

Remove the two heater hoses (Item 1) [Figure 70-80-31] from the engine.

## ENGINE / HYDROSTAT ASSEMBLY (CONT'D)

### Removal And Installation (Cont'd)

Figure 70-80-32

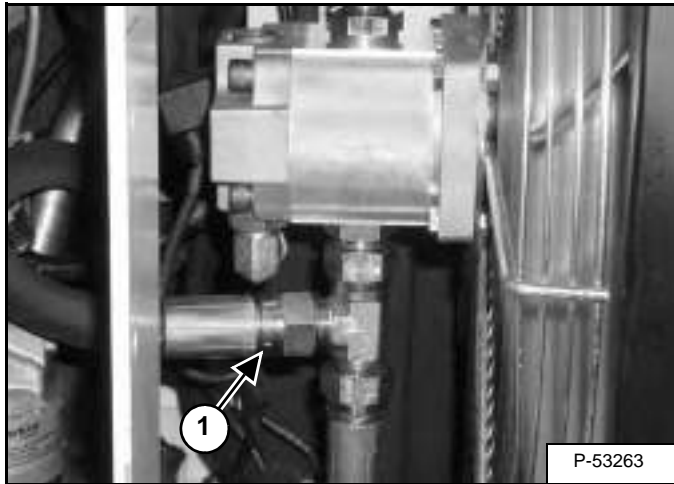

Remove the hose (Item 1) [Figure 70-80-32] from the fan motor.

Figure 70-80-33

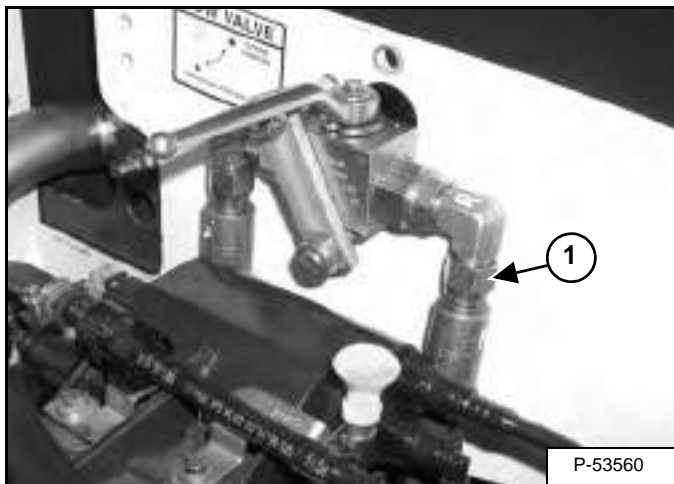

Remove the two hoses (Item 1) [Figure 70-80-33] from the tow valve.

Figure 70-80-34

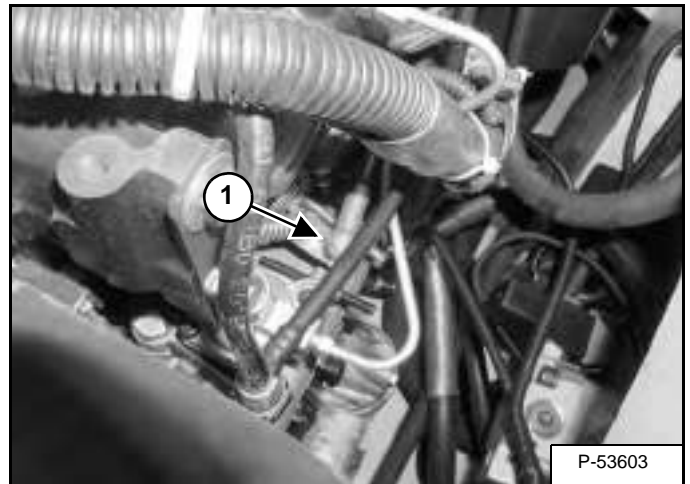

Remove the engine speed control cable (Item 1) [Figure 70-80-34].

Figure 70-80-35

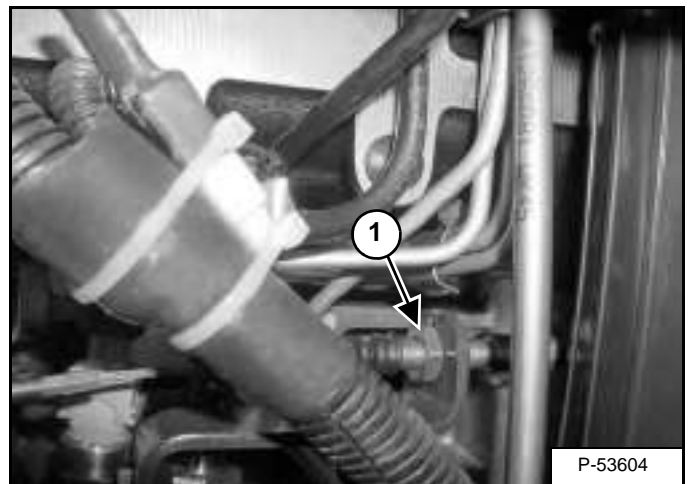

Remove the engine speed control cable (Item 1) [Figure 70-80-35] from the bracket.



## ENGINE / HYDROSTAT ASSEMBLY (CONT'D)

### Removal And Installation (Cont'd)

Figure 70-80-36

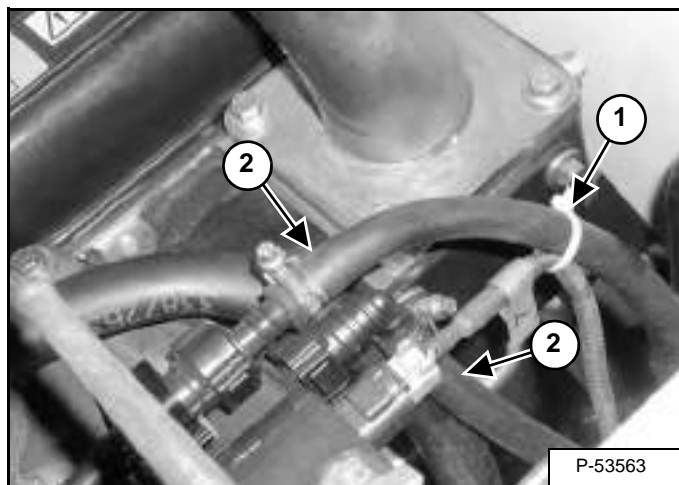

Cut the tie strap (Item 1) and remove the two fuel lines (Item 2) [Figure 70-80-36].

Figure 70-80-37



Remove the heater hoses, fuel lines and speed control cable from the engine compartment and route through the access hole [Figure 70-80-37].

Figure 70-80-38

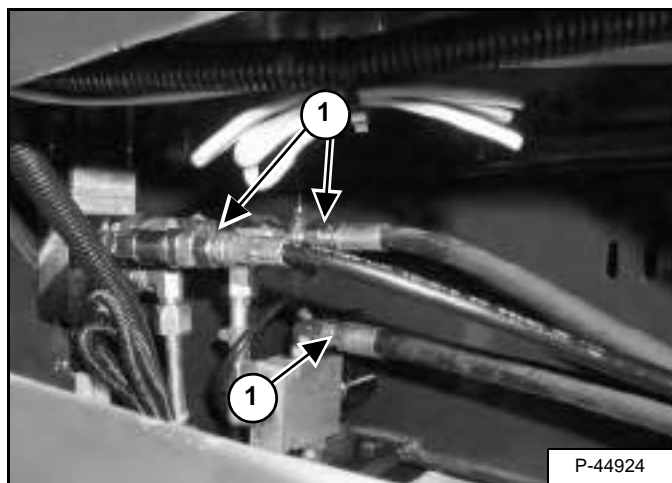

Remove the three hoses (Item 1) [Figure 70-80-38].

Remove any necessary nylon ties.

Figure 70-80-39

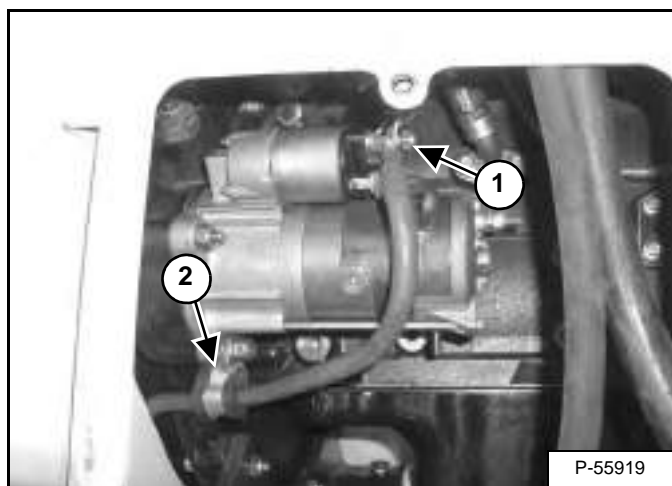

Remove nut (Item 1) and cable clamp (Item 2) [Figure 70-80-39].



## ENGINE / HYDROSTAT ASSEMBLY (CONT'D)

### Removal And Installation (Cont'd)

Figure 70-80-40

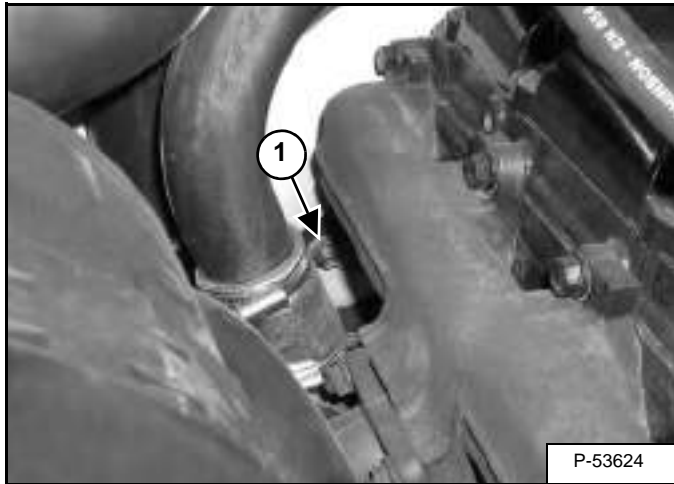

Route the ground strap mounting bolt (Item 1) [Figure 70-80-40].

Figure 70-80-41



Install a chain hoist to lift and secure the engine assembly [Figure 70-80-41].

Figure 70-80-42

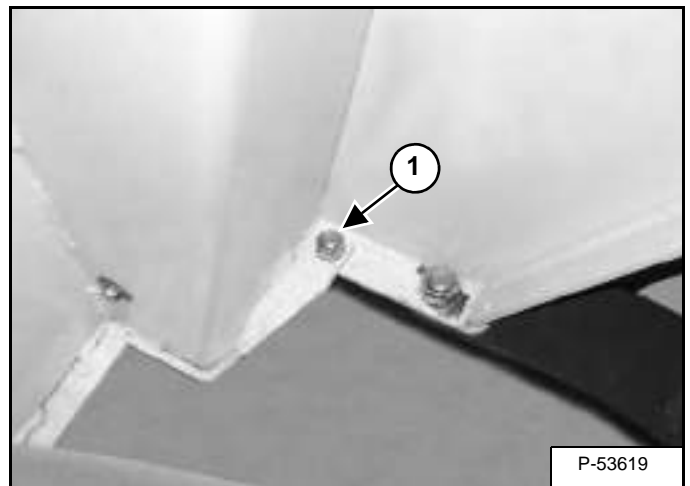

Remove the engine assembly mounting bolt (Item 1) [Figure 70-80-42] from the lower front.

## ENGINE / HYDROSTAT ASSEMBLY (CONT'D)

### Removal And Installation (Cont'd)

Figure 70-80-43

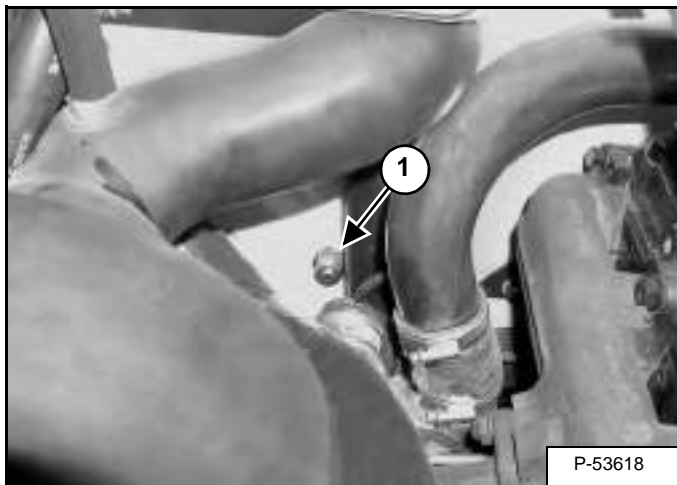

Figure 70-80-44

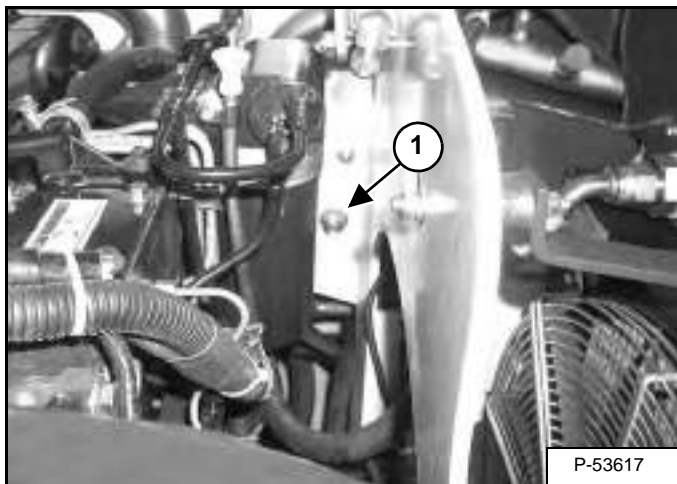
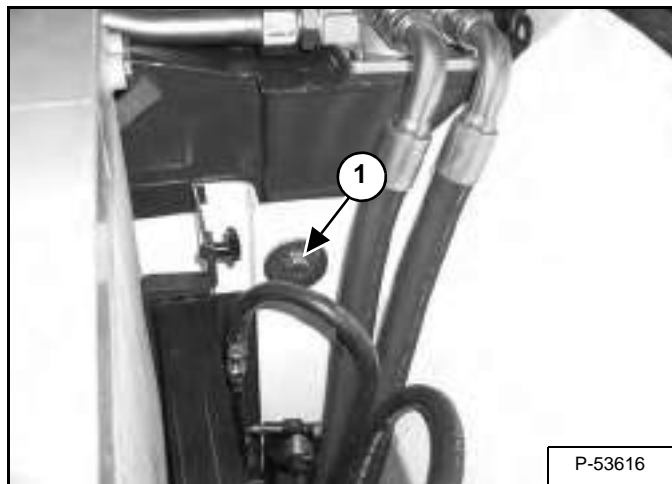

Figure 70-80-45



Remove the three engine assembly mounting bolts (Item 1) [Figure 70-80-43], [Figure 70-80-44], & [Figure 70-80-45].

Figure 70-80-46



Lift the engine assembly up approximately one inch (25 mm) and remove the engine assembly from the machine [Figure 70-80-46].

## FLYWHEEL AND HOUSING

### Removal And Installation

Remove the engine / hydrostatic assembly (See "Removal And Installation" on page 70-80-1).

**NOTE: Set the engine / hydrostatic assembly on blocks, to allow access to remove the motor mount bolts.**

Remove the hydrostatic pump (See "Removal And Installation" on page 30-40-1).

Remove the starter (See "Removal And Installation" on page 60-40-1).

Figure 70-90-1

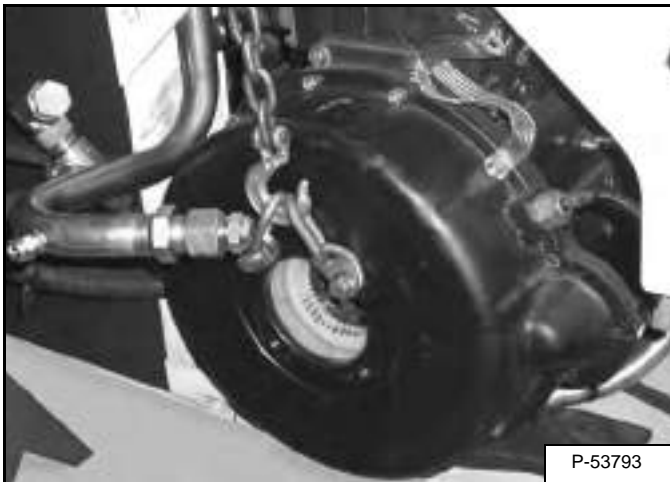

Install lifting brackets and hoist on the housing to lift and support [Figure 70-90-1].

Figure 70-90-2

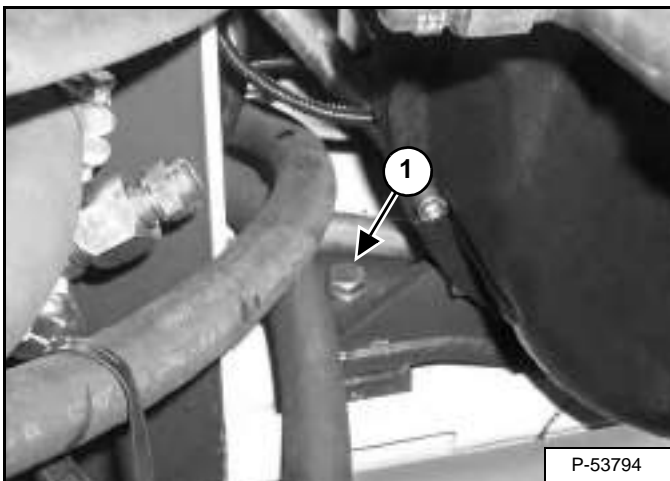
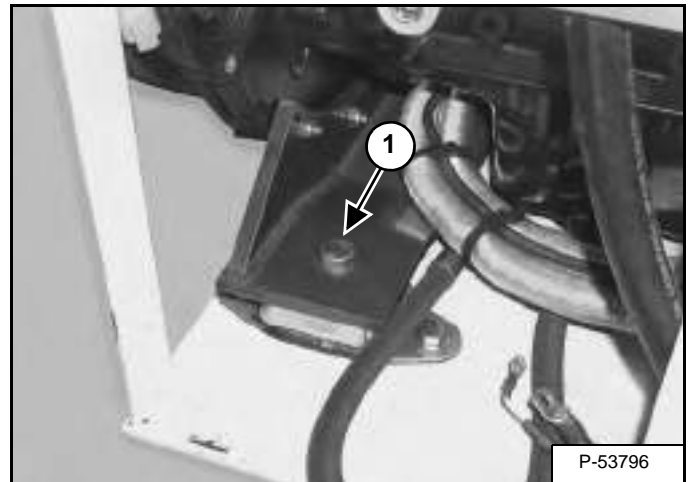

Figure 70-90-3



Remove both rear engine mounting bolts (Item 1) [Figure 70-90-2] & [Figure 70-90-3].

**Installation:** Tighten engine mounting bolts to 185-200 ft.-lb. (250-271 N•m) torque.

Figure 70-90-4



Lifting from the housing assembly, raise the engine slightly and place support blocks under the oil pan [Figure 70-90-4].

Lower the engine assembly on the support blocks.

## FLYWHEEL AND HOUSING (CONT'D)

### Removal And Installation (Cont'd)

Figure 70-90-5

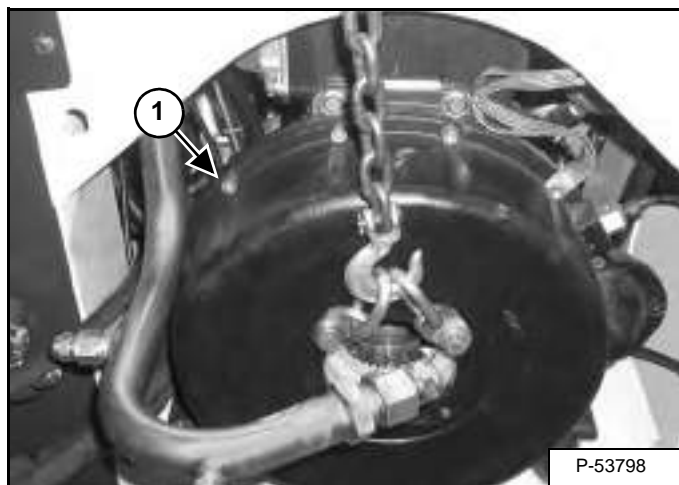

Loosen and remove the ten flywheel housing mount bolts (Item 1) [Figure 70-90-5].

**Installation:** Tighten to 40-45 ft.-lb. (54-61 N•m) torque.

Figure 70-90-6

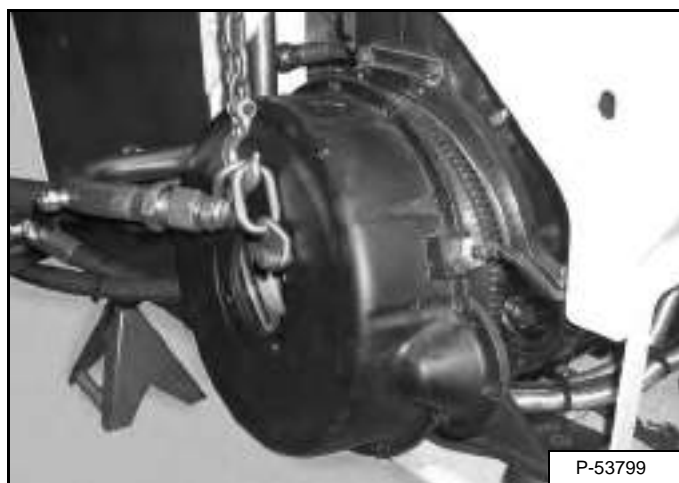

Remove the flywheel housing from the engine [Figure 70-90-6].

Figure 70-90-7

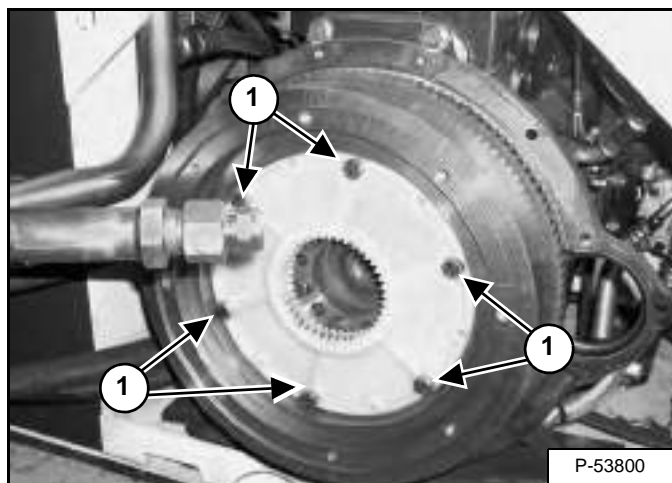

Remove the six coupler mounting bolts (Item 1) [Figure 70-90-7]. Remove the coupler.

**Installation:** Tighten the bolts to 40-45 ft.-lb. (54-61 N•m) torque.

Figure 70-90-8

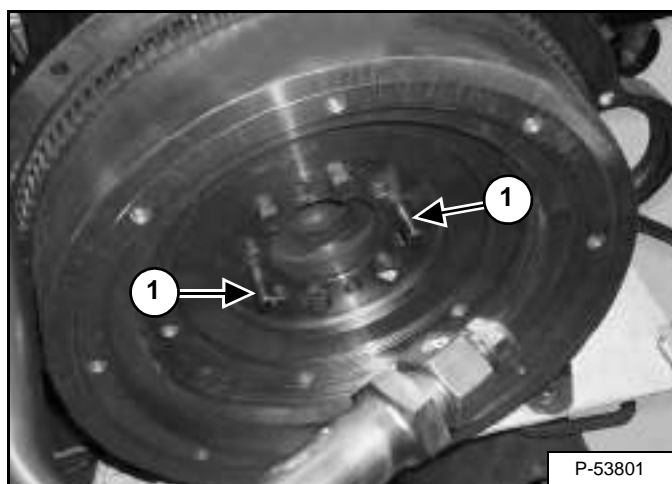

Remove two of the flywheel mount bolts and install two guide studs (Item 1) [Figure 70-90-8] in the flywheel to prevent the fly wheel from falling.

## FLYWHEEL AND HOUSING (CONT'D)

### Removal And Installation (Cont'd)

Figure 70-90-9

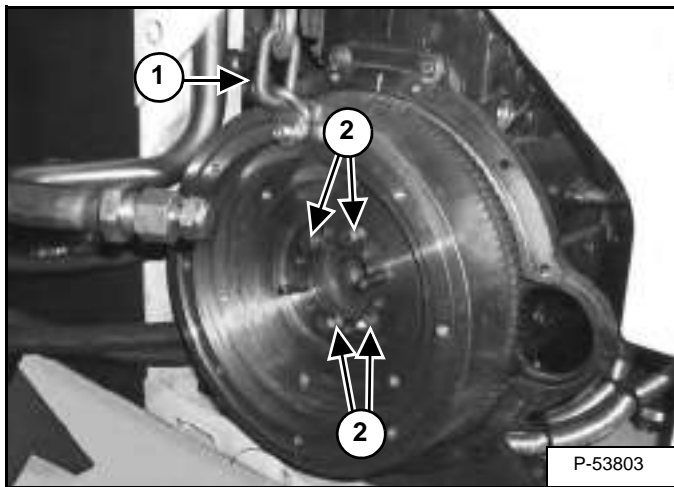

Install a chain hoist (Item 1) [Figure 70-90-9].

Remove the remainder of the bolts (Item 2) [Figure 70-90-9]. Remove the flywheel by sliding outward over the guide studs.

**Installation:** Tighten the flywheel bolts to 77 ft.-lb. (105 N•m) torque.

Figure 70-90-10

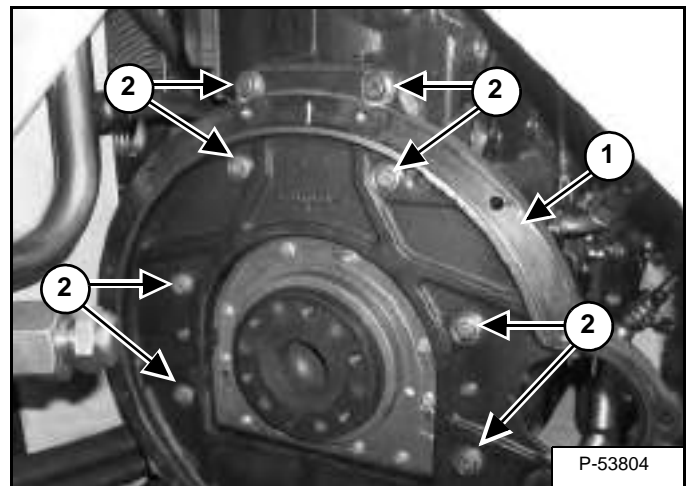

If removing the backing plate (Item 1) is required, loosen and remove the eight mounting bolts (Item 2) [Figure 70-90-10].

**Installation:** Tighten the bolts to 52 ft.-lb. (70 N•m) torque.

Check the flywheel and ring gear for wear or damage. Replace as needed.

## FLYWHEEL AND HOUSING (CONT'D)

### Removal And Installation (Cont'd)

Figure 70-90-11

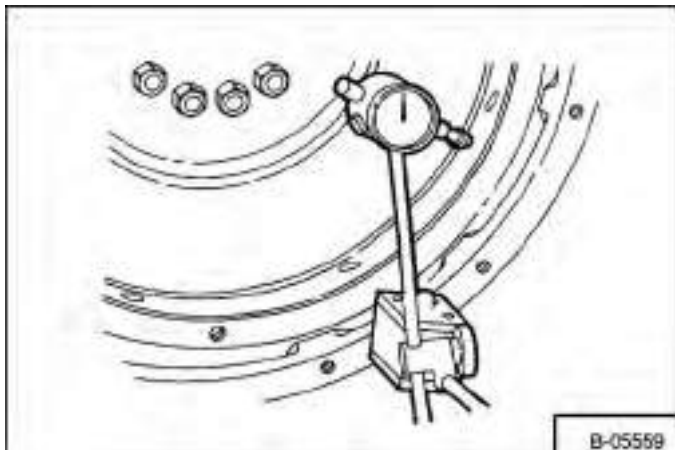

Install a dial indicator to check the flywheel run out [Figure 70-90-11].

Flywheel run out must be less than 0.012 inch (0,30 mm).

Figure 70-90-12

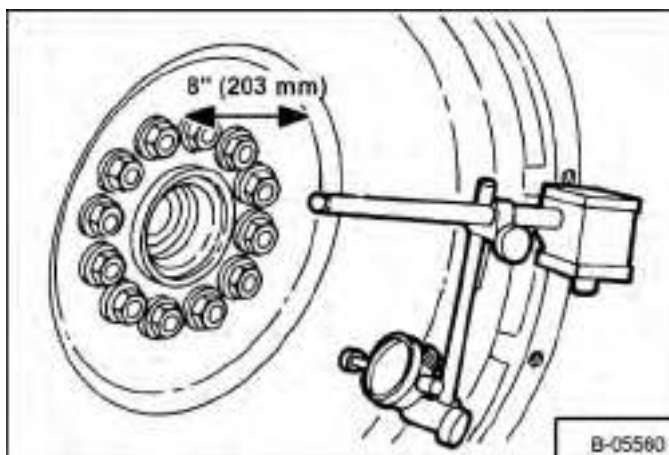

Check the alignment of the flywheel face [Figure 70-90-12].

The misalignment must not be more than 0.001 inch (0,03 mm) total indicator reading for every 1.0 inch (25 mm) of the flywheel radius from the crankshaft axis to the dial gauge plunger.

Example: The misalignment must not be greater than 0.008 inch (0,203 mm) at 8 inches. (203 mm) from the centerline of the crankshaft towards the outside of the flywheel.

During this check keep the crankshaft pressed toward the front so crankshaft end play will not affect the reading.

### Ring Gear Removal

Before the ring gear is removed note the position of the chamfer on the teeth.

Heat the ring gear enough to expand it and hit it with a hammer evenly to remove it.

Be careful not to damage the flywheel during this operation.

### Ring Gear Installation

The ring gear is a heat expansion fit on the flywheel.

Do not heat the ring gear to a temperature greater than 480° F (250° C) make sure the ring gear chamfer is in the correct position.

## RECONDITIONING THE ENGINE

### Turbo Charger Troubleshooting

The chart below is given to assist in the correct diagnosis of turbocharger faults.

If the inside of the intake manifold is wet, check that there is not a fuel leak from the starting aid.

PROBLEM	CAUSE
Not enough power	1, 4, 5, 6, 7, 8, 9, 10, 11, 18, 20, 21, 22, 25, 26, 27, 28
Black Smoke	1, 4, 5, 6, 7, 8, 9, 10, 11, 18, 20, 21, 22, 25, 26, 27, 28
Blue Smoke	1, 2, 4, 6, 8, 9, 17, 19, 20, 21, 22, 30, 31, 32
High Lubricating Oil Consumption	2, 8, 15, 17, 19, 20, 28, 29, 31, 32
Too Much Lubricating Oil At Turbine End	2, 7, 8, 17, 19, 20, 22, 28, 30, 31, 32
Too Much Lubricating Oil At Compressor End	1, 2, 4, 5, 6, 8, 19, 20, 21, 28, 31, 32
Not Enough Lubrication	8, 12, 14, 15, 16, 23, 24, 29, 32, 33, 34, 35
Lubricating Oil In The Exhaust Manifold	2, 7, 17, 18, 19, 20, 22, 28, 31, 32
Inside The Induction Manifold Wet	1, 2, 3, 4, 5, 6, 8, 10, 11, 17, 18, 19, 20, 21, 28, 32, 36, 37
Damaged Compressor Impeller	3, 4, 6, 8, 12, 15, 16, 20, 21, 23, 24, 29, 32, 33, 35, 36
Damaged Turbine Rotor	7, 8, 12, 13, 14, 15, 16, 18, 20, 22, 23, 24, 25, 27, 29, 29, 32, 33, 34, 35
Rotating Assembly Does Not Turn Freely	3, 6, 7, 8, 12, 13, 14, 15, 16, 18, 20, 21, 22, 23, 24, 29, 32, 33, 34, 35
Worn Bearings, Bearing Bores, Journals	6, 7, 8, 12, 13, 14, 15, 16, 23, 24, 29, 33, 34, 35
Noise From Turbocharger	1, 3, 4, 5, 6, 7, 8, 9, 10, 11, 12, 13, 14, 15, 16, 17, 18, 20, 21, 22, 23, 24, 29, 32, 33, 34, 35
Sludge or Carbon Deposit In Bearing Housing	2, 11, 13, 14, 15, 17, 18, 24, 29, 33, 34, 35

KEY TO CORRECT THE CAUSE	
1. Air filter element dirty.	17. Restricted lubricating oil drain pipe.
2. Restricted crankcase breather.	18. Turbine housing damage or restricted.
3. Air filter element missing, leaking or not sealing correctly. Loose connection to turbocharger.	19. Leakage from turbocharger seals.
4. Internal distortion or restriction in pipe from air filter to turbocharger.	20. Worn turbocharger bearings.
5. Damaged/restricted crossover pipe, turbocharger to induction manifold.	21. Excessive dirt in turbocharger housing.
6. Restriction between air filter and turbocharger.	22. Excessive carbon behind turbine rotor.
7. Restriction in exhaust system.	23. Engine speed raised too rapidly at initial start.
8. Turbocharger loose or clamps/setscrews loose.	24. Insufficient engine idle period.
9. Induction manifold cracked or loose, flanges distorted.	25. Faulty fuel injection pump.
10. Exhaust manifold cracked or loose.	26. Worn or damaged fuel injectors.
11. Restricted exhaust system.	27. Valves burned.
12. Delay of lubricating oil to turbocharger at engine start.	28. Worn piston rings. flanges distorted.
13. Insufficient lubrication.	29. Lubricating oil leakage from supply pipe.
14. Dirty lubricating oil.	30. Excessive starting fluid (on initial engine start).
15. Incorrect lubricating oil.	31. Excessive engine idle period.
16. Restricted lubricating oil supply pipe.	32. Restriction in turbocharger bearing housing.
	33. Restriction in lubricating oil filter.
	34. Engine stopped too soon from high load.
	35. Insufficient lubricating oil.
	36. Fuel leakage from fuelled starting aid.
	37. Crack in back plate of compressor.

## RECONDITIONING THE ENGINE (CONT'D)

### Turbo Charger Description

# ! WARNING

Turbochargers, operate at high speed and high temperatures. Keep fingers, tools and other objects away from the inlet and outlet ports. Avoid contact with hot surfaces.

W-2257-1196

Figure 70-100-1

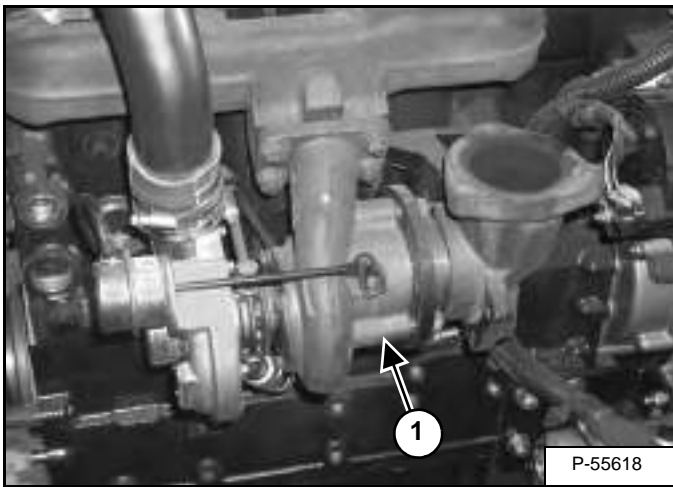

The turbocharger (Item 1) [Figure 70-100-1] is placed between the exhaust and intake manifolds. It is driven by hot exhaust gases and supplies air at more than atmospheric pressure to the intake. It is lubricated by oil from the main gallery.

The oil flows from the filter adapter through the bearing housing and returns to the engine block.

The turbocharger should only be serviced by an authorized dealer or repair shop.

## Turbo Charger Removal And Installation

Figure 70-100-2

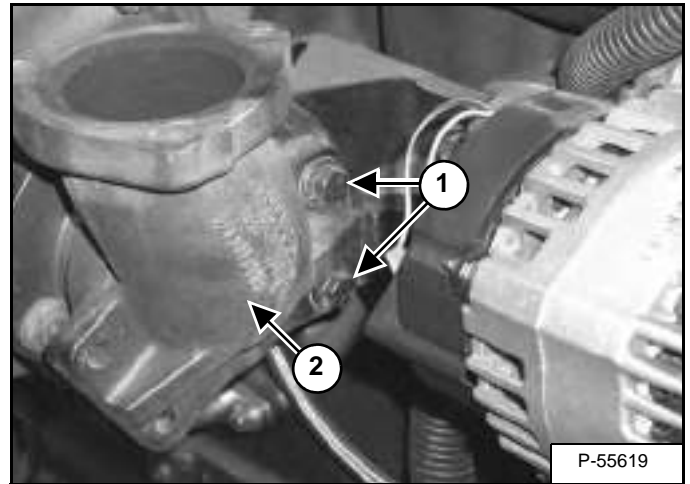

Remove the two bolts (Item 1) and remove the extension tube (Item 2) [Figure 70-100-2].

Figure 70-100-3

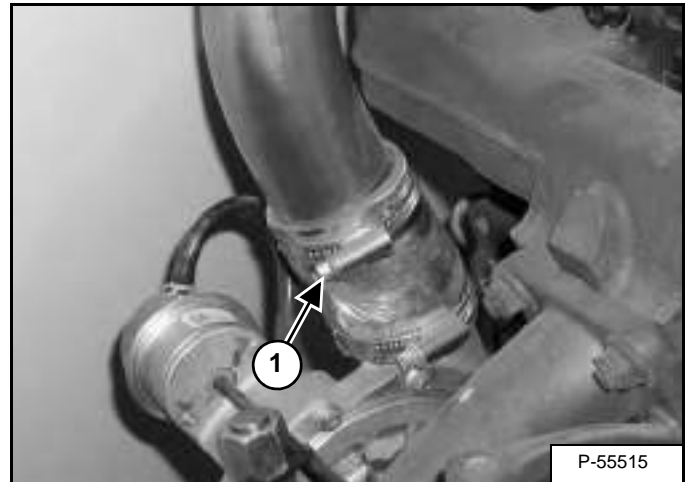

Loosen the intake tube clamp (Item 1) [Figure 70-100-3].



## RECONDITIONING THE ENGINE (CONT'D)

### Turbo Charger Removal And Installation (Cont'd)

Figure 70-100-4

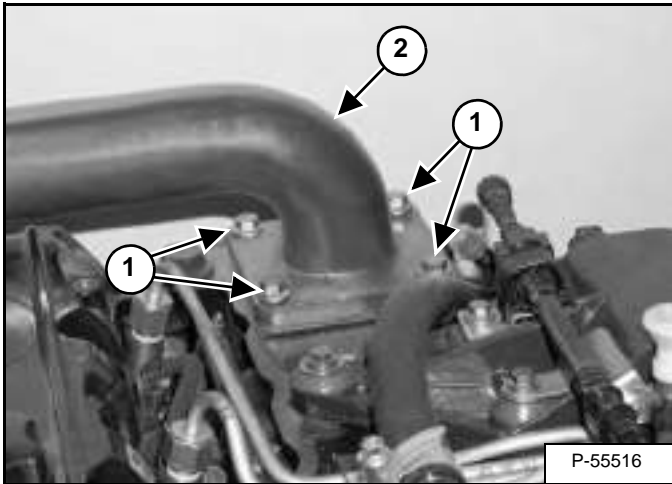

Remove the four bolts (Item 1) and remove the intake tube (Item 2) [Figure 70-100-4].

Figure 70-100-5

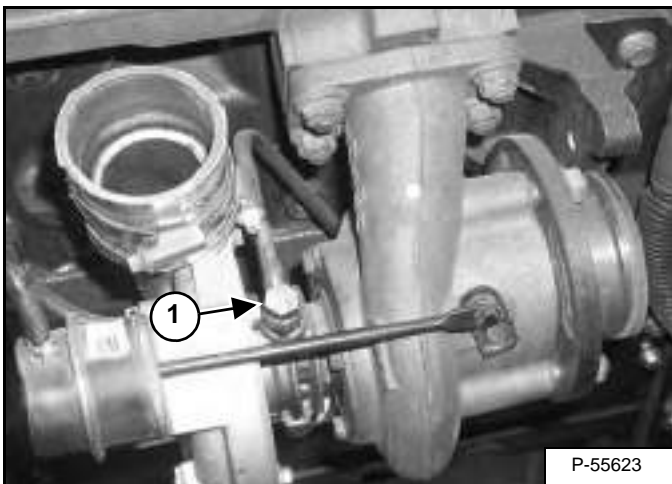

Disconnect the oil supply tubeline (Item 1) [Figure 70-100-5].

**Installation:** Fill the bearing housing with clean oil through the oil supply port. Tighten banjo fitting to 16 ft.-lb. (22 N•m) torque.

Figure 70-100-6

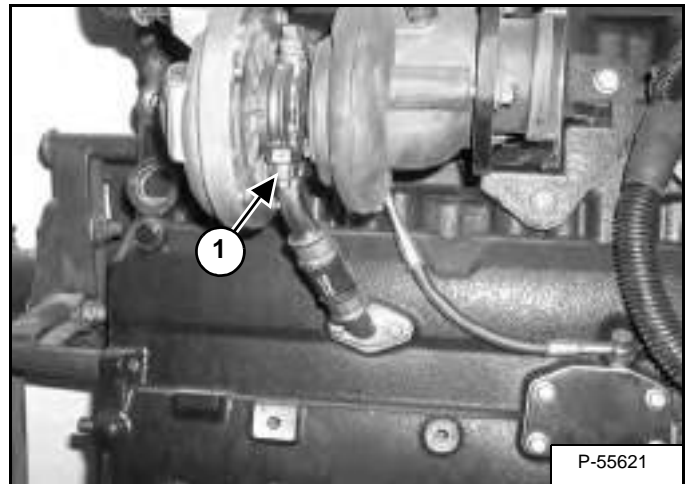

Remove the oil return line (Item 1) [Figure 70-100-6].

Figure 70-100-7

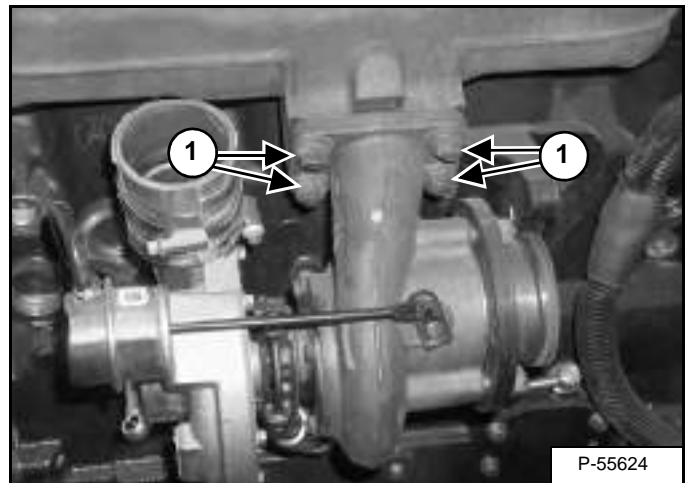

Remove the four nuts (Item 1) [Figure 70-100-7] for the turbocharger to exhaust manifold flange.

**Installation:** Apply anti-seize compound to the mounting studs. Tighten the nuts to 33 ft.-lb. (44 N•m) torque.

Remove the turbocharger and gasket from the exhaust manifold.

The turbocharger must only be serviced by an authorized repair shop.

Before starting the engine, disconnect the electrical stop control. Crank the engine until oil pressure is obtained. Stop cranking and reconnect the stop control.

## RECONDITIONING THE ENGINE (CONT'D)

### Exhaust Manifold Removal And Installation

Remove the turbocharger (See "Turbo Charger Removal And Installation" on page 70-100-2).

Figure 70-100-8

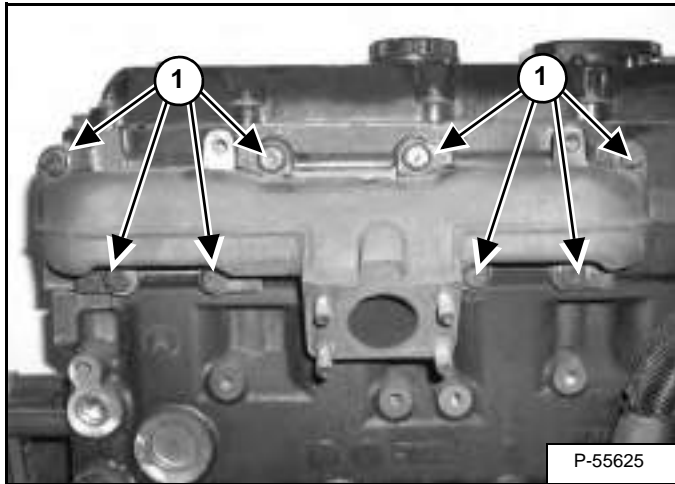

Remove the eight mount bolts (Item 1) [Figure 70-100-8].

Remove the exhaust manifold and gasket.

Figure 70-100-9

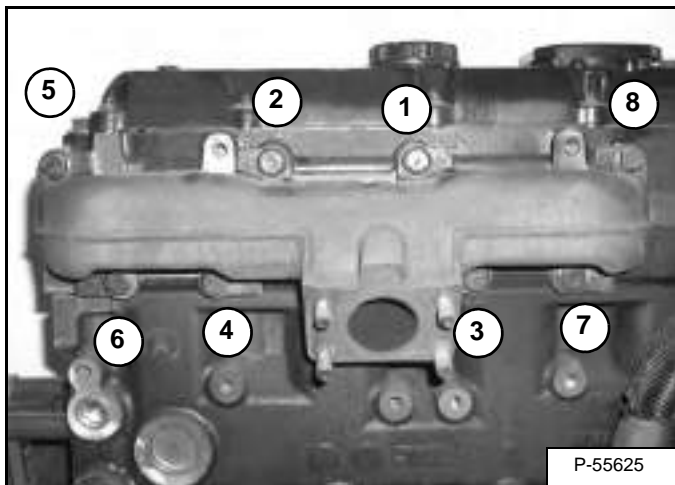

**Installation:** Tighten the bolts in the sequence shown [Figure 70-100-9] to 24 ft.-lb. (33 N•m) torque.

### Fuel Injector Cover Removal And Installation

Figure 70-100-10

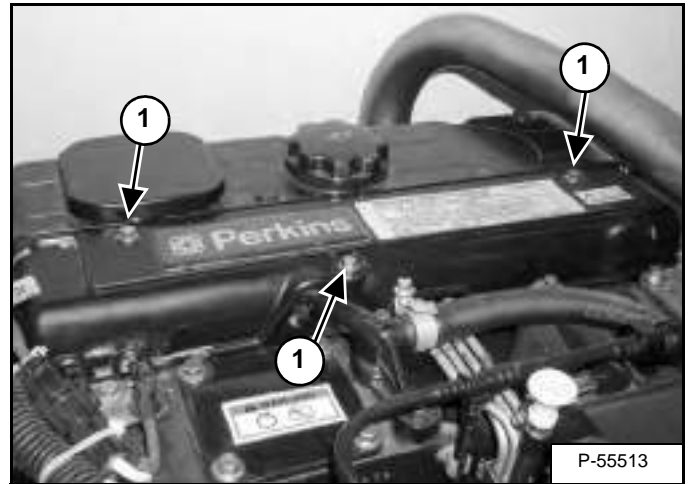

Remove the three bolts (Item 1) [Figure 70-100-10].

**Installation:** Tighten the bolts to 7 ft.-lb. (9 N•m) torque.

Figure 70-100-11

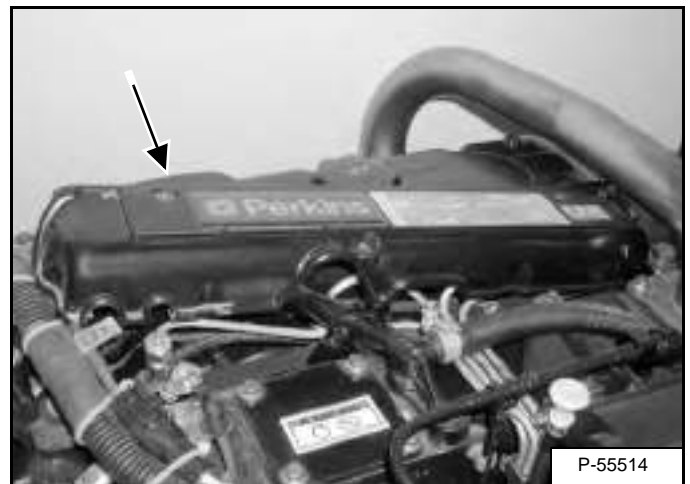

Remove the cover [Figure 70-100-11].

## RECONDITIONING THE ENGINE (CONT'D)

### Rocker Cover Removal And Installation

Remove the fuel injector cover (See "Fuel Injector Cover Removal And Installation" on page 70-100-4).

Figure 70-100-12

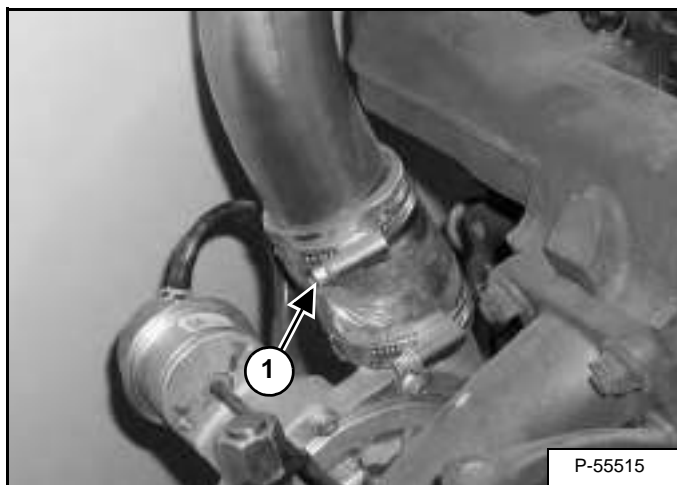

Loosen the intake tube clamp (Item 1) [Figure 70-100-12].

Figure 70-100-13

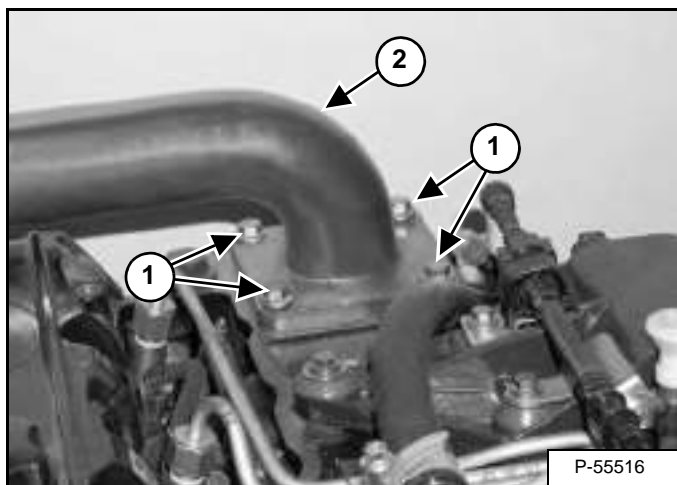

Remove the four bolts (Item 1) and remove the intake tube (Item 2) [Figure 70-100-13].

Figure 70-100-14

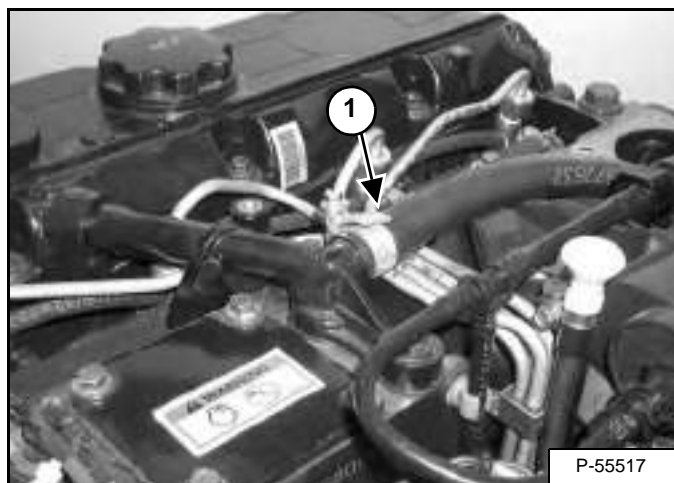

Remove the breather hose (Item 1) [Figure 70-100-14].

Figure 70-100-15

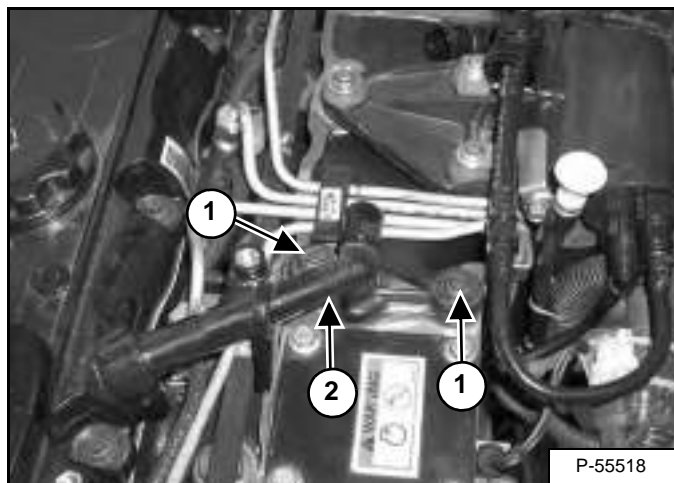

Remove the two bolts (Item 1) and remove the breather fitting (Item 2) [Figure 70-100-15].

## RECONDITIONING THE ENGINE (CONT'D)

### Rocker Cover Removal And Installation (Cont'd)

Figure 70-100-16

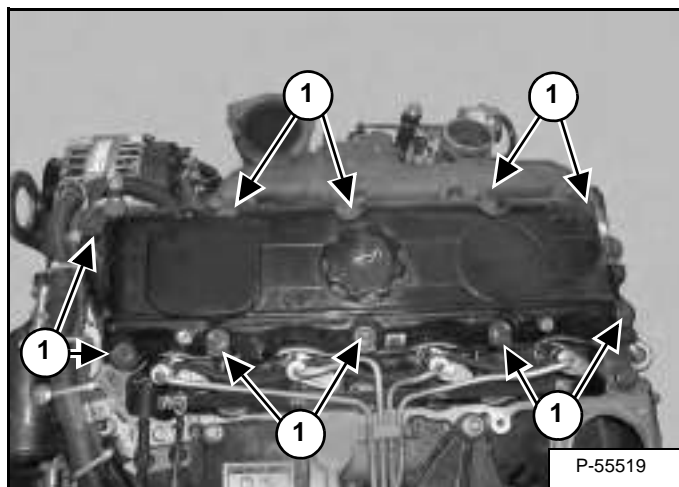

Remove the ten mount bolts (Item 1) [Figure 70-100-16].

Figure 70-100-17

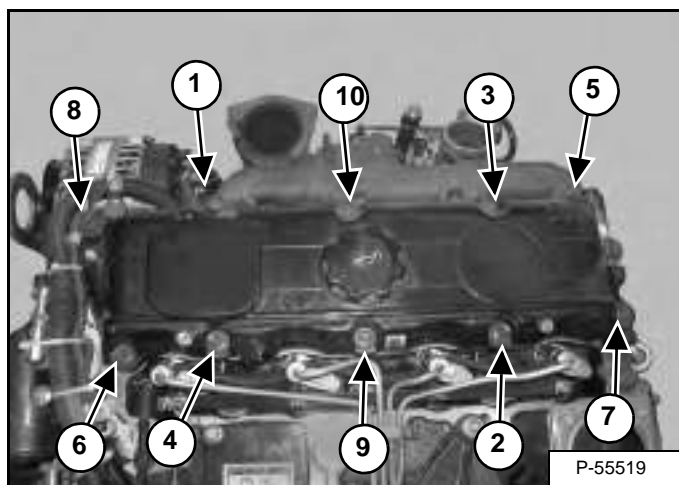

**Installation:** Tighten the bolts in the sequence shown [Figure 70-100-17] to 7 ft.-lb. (9 N•m) torque.

### Cylinder Head Removal

Remove the turbo charger (See "Turbo Charger Removal And Installation" on page 70-100-2).

Remove the exhaust manifold (See "Exhaust Manifold Removal And Installation" on page 70-100-4).

Remove the alternator (See "Removal And Installation" on page 60-30-1).

Remove the fuel lift pump (See "Fuel Lift Pump Removal And Installation" on page 70-70-10).

Remove the fuel injectors (See "Fuel Injectors Removal And Installation" on page 70-70-7).

Remove the glow plugs (See "Glow Plugs Removal And Installation" on page 70-70-12).

Figure 70-100-18

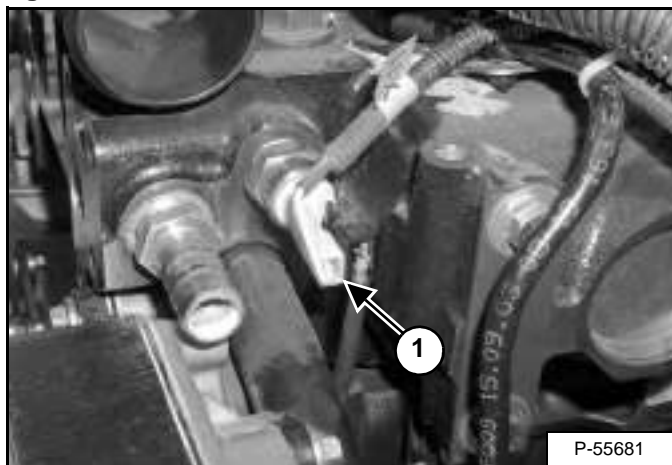

Unplug the engine cooling temperature sensor (Item 1) [Figure 70-100-18].

**NOTE:** Mark wires for correct installation.

Figure 70-100-19

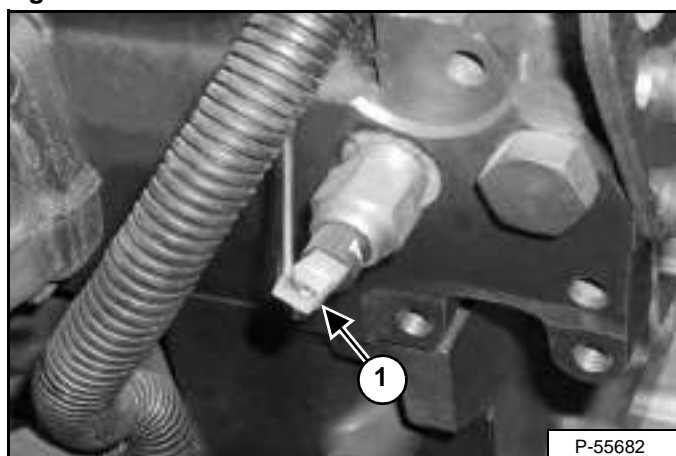

Unplug the intake manifold pressure sensor (Item 1) [Figure 70-100-19].

Reposition the harness.

## RECONDITIONING THE ENGINE (CONT'D)

### Cylinder Head Removal (Cont'd)

Figure 70-100-20

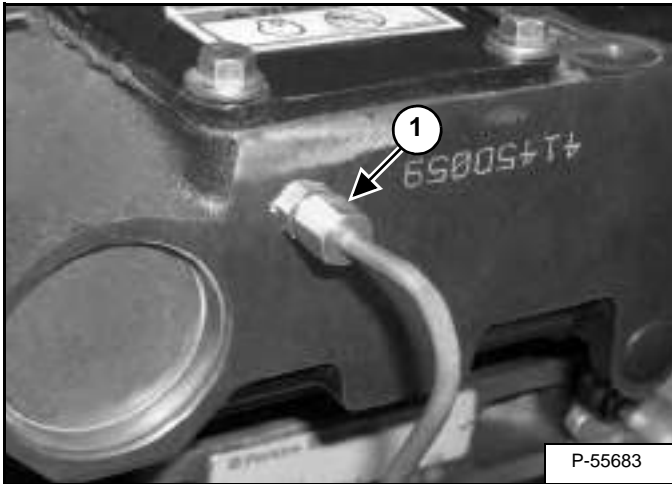

Remove the tubeline (Item 1) [Figure 70-100-20].

Figure 70-100-21

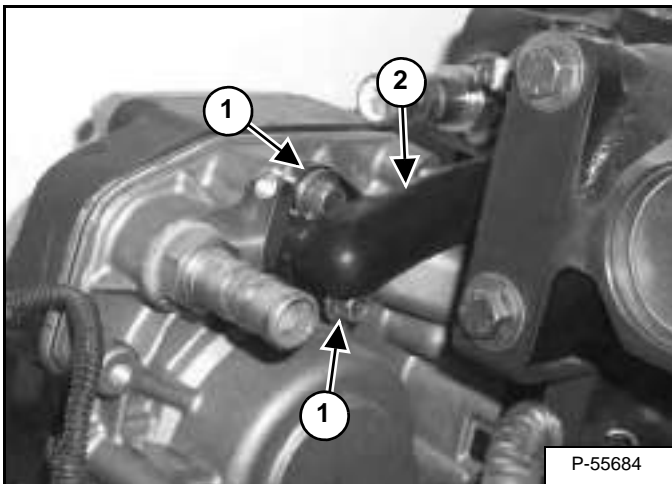

Remove the two bolts (Item 1) and remove the coolant bypass tube (Item 2) [Figure 70-100-21].

Remove the rocker cover (See "Rocker Cover Removal And Installation" on page 70-100-5).

Remove the rocker assembly (See "Rocker Shaft Disassembly And Assembly" on page 70-100-11).

Figure 70-100-22

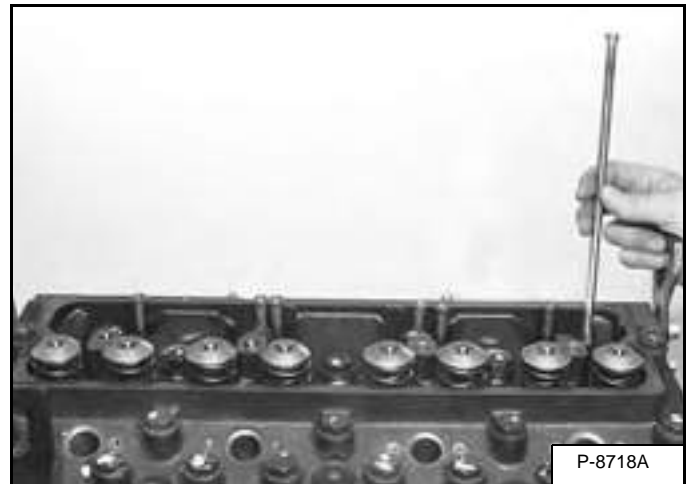

Remove the push rods [Figure 70-100-22].

Figure 70-100-23

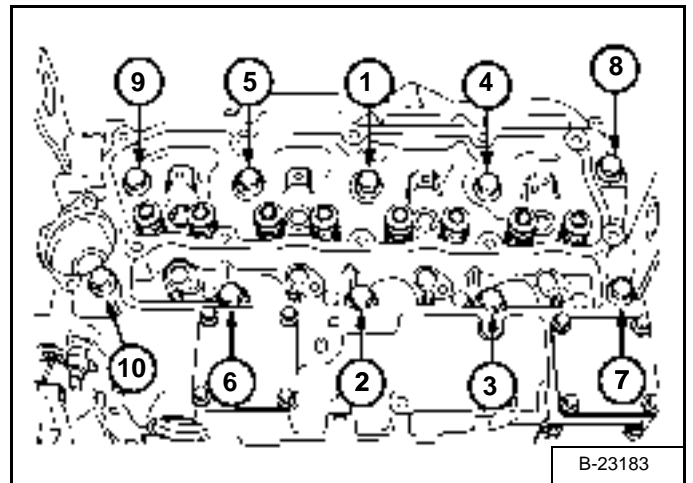

Release the cylinder head bolts evenly and gradually in the sequence shown [Figure 70-100-23].

Check the head bolts for distortion and damage. Replace as needed.

Lift off the cylinder head and clean the bottom face.

## RECONDITIONING THE ENGINE (CONT'D)

### Cylinder Head Inspection

Figure 70-100-24

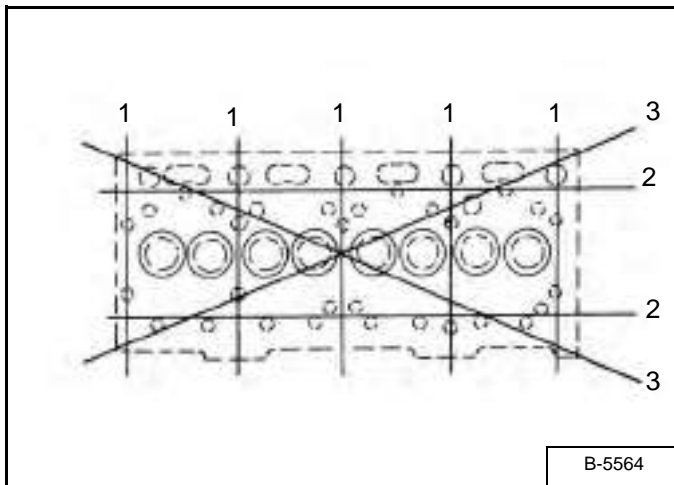

Put a straight edge on the cylinder head as shown in [Figure 70-100-24].

Using a feeler gauge between the straight edge and head, check for warping.

Maximum allowed (Item 1) is 0.0012 inches (0,03 mm), (Item 2) is 0.0019 inches (0,05 mm) and (Item 3) [Figure 70-100-24] is 0.0019 inches (0,05 mm).

The head may be machined removing only a minimum amount. Head thickness must not be less than 4.614 inches (117,20 mm).

Completely clean the rest of the head.

Check for cracks or other damage.

### Cylinder Head Installation

Make sure the mating surfaces of the head and block are clean.

Clean the engine block bolt bores with the correct size tap to ensure correct torque for the cylinder head bolts.

Clean any debris out of the cylinder bores.

Figure 70-100-25

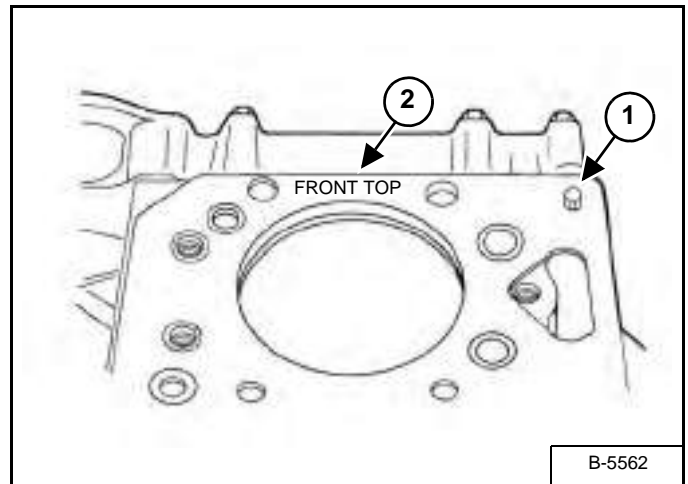

**NOTE: The locating pins (Item 1) are pressed in the engine block so the head gasket (Item 2) [Figure 70-100-25] can be positioned correctly.**

The head gasket is installed with no sealer.

Place the head gasket in position with the *Front Top* (Item 2) [Figure 70-100-25] marks in the correct position.

Lower the cylinder head in position.

## RECONDITIONING THE ENGINE (CONT'D)

### Cylinder Head Installation (Cont'd)

Figure 70-100-26

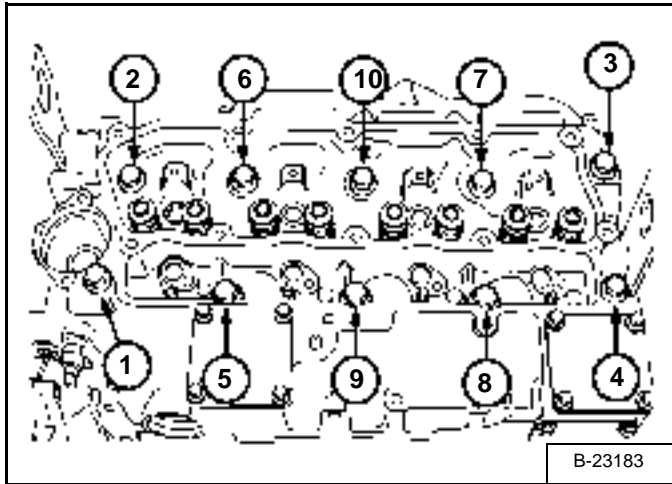

Tighten the head bolts to 37 ft.-lb. (50 N•m) in the sequence shown [Figure 70-100-26].

Tighten the head bolts to 74 ft.-lb. (100 N•m) in the sequence shown [Figure 70-100-26].

Figure 70-100-27

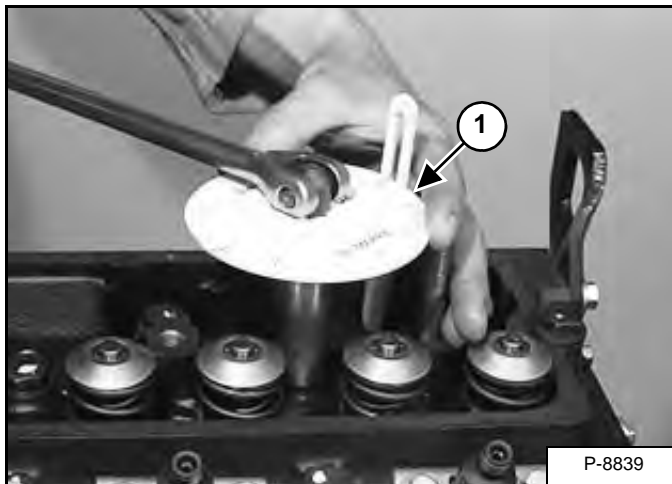

Additional tightening of the head bolts requires the use of a torque angle gauge (Item 1) [Figure 70-100-27]. Tighten the short bolts to 225° and long bolts to 270° in the same sequence as shown in [Figure 70-100-26].

Figure 70-100-28

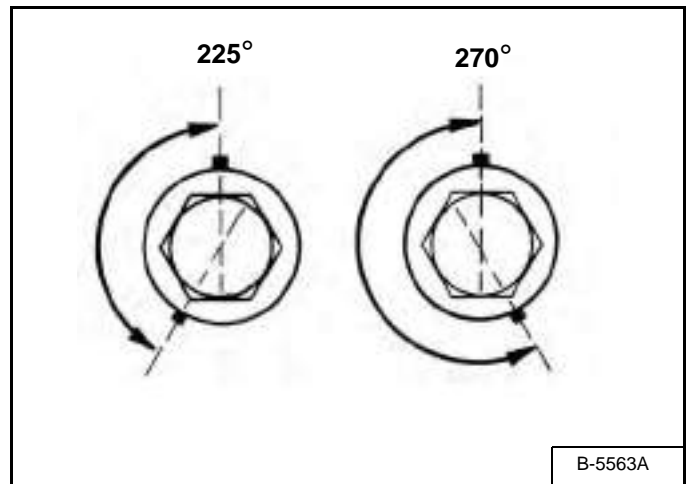

If no angle gauge is available make a suitable mark on the head bolt corner. Make another mark on the cylinder head the correct number of flats away [Figure 70-100-28]. Turn the head bolt until the lines match.

Figure 70-100-29

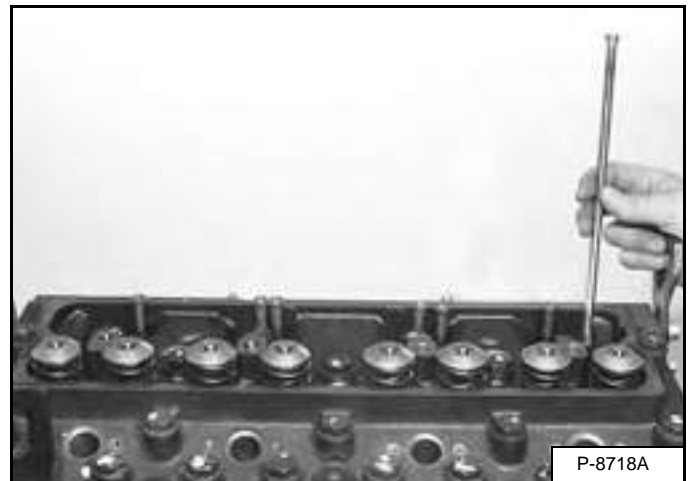

Install the push rods [Figure 70-100-29].

Make sure the push rods seat in the tappet sockets.

Install the rocker assembly (See "Rocker Shaft Disassembly And Assembly" on page 70-100-11).

Install the rocker cover (See "Rocker Cover Removal And Installation" on page 70-100-5.)

## RECONDITIONING THE ENGINE (CONT'D)

### Cylinder Head Installation (Cont'd)

Figure 70-100-30

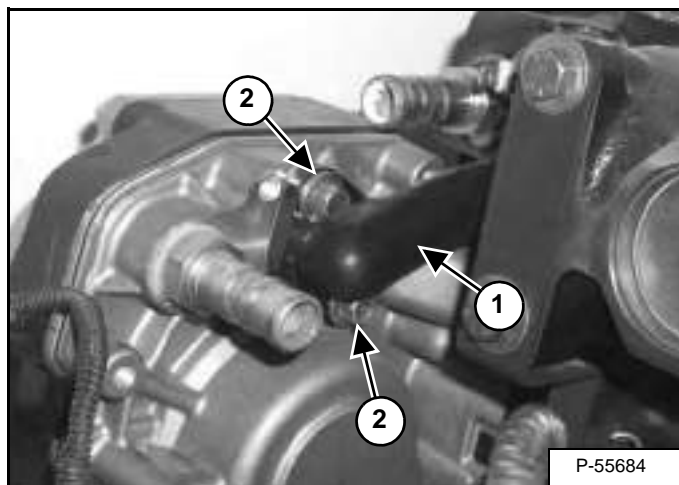

Install the coolant by-pass pipe (Item 1) and two screws (Item 2) [Figure 70-100-30].

Figure 70-100-31

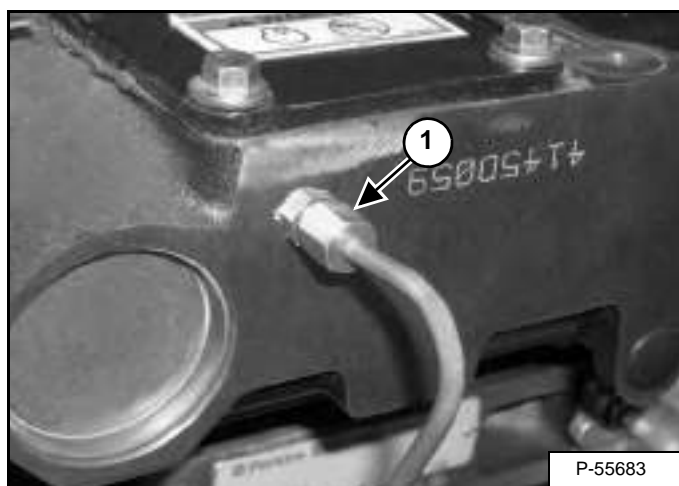

Install the tubeline (Item 1) [Figure 70-100-31].

Figure 70-100-32

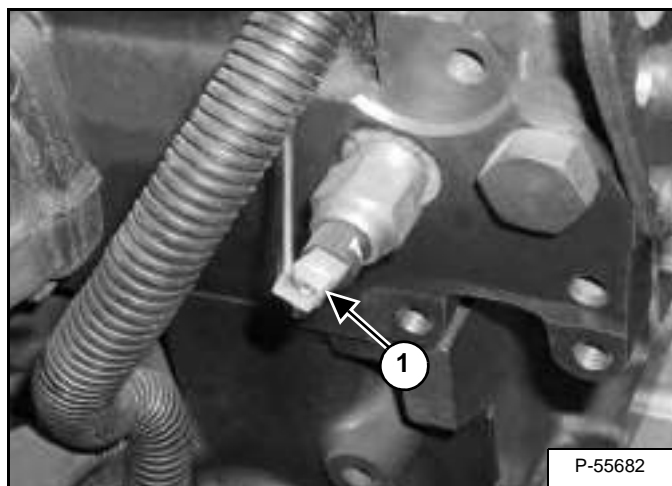

Connect the intake manifold pressure sensor (Item 1) [Figure 70-100-32].

Figure 70-100-33

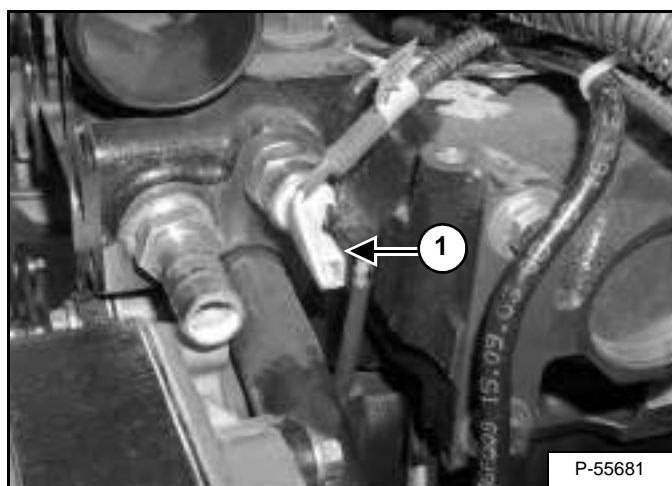

Connect the engine cooling temperature sensor (Item 1) [Figure 70-100-33].

Install the glow plugs (See "Glow Plugs Removal And Installation" on page 70-70-12).

Install the fuel injectors (See "Fuel Injectors Removal And Installation" on page 70-70-7).

Install the fuel lift pump (See "Fuel Lift Pump Removal And Installation" on page 70-70-10).

Install the alternator (See "Removal And Installation" on page 60-30-1).

Install the exhaust manifold (See "Exhaust Manifold Removal And Installation" on page 70-100-4).

Install the turbo charger (See "Turbo Charger Removal And Installation" on page 70-100-2).



## RECONDITIONING THE ENGINE (CONT'D)

### Rocker Shaft Disassembly And Assembly

Figure 70-100-34

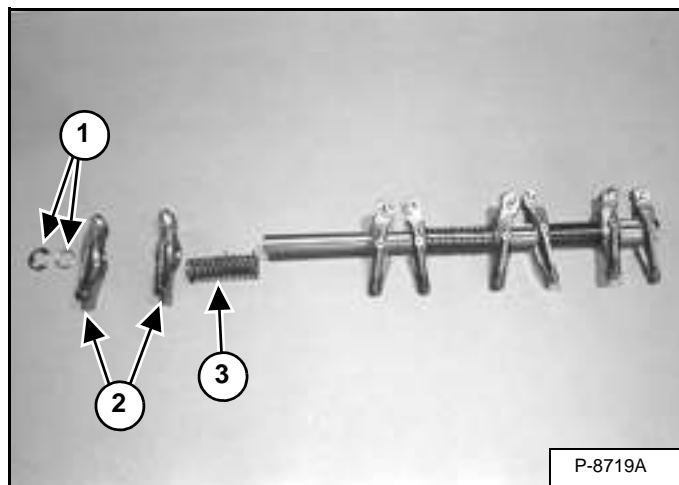

Remove the clips (Item 1) [Figure 70-100-34] from both ends of the shaft.

Remove the rocker arm (Item 2) and spring (Item 3) [Figure 70-100-34].

Continue to disassemble the rocker shaft.

Clean and inspect all components for damage and wear.

Check the clearance between the rocker arms and shaft.

Using a press and adapter, remove the old bushing and press in the new one making sure the oil holes line up.

Shaft O.D.	0.9828-0.9837 inch (24,96-24,99 mm)
Rocker Arm Bore Dia.	0.9848-09.863 inch (25,02-25,05 mm)
Clearance Between Rocker Arm & Shaft	0.0010-0.0035 inch (0,026-0,089 mm)

If the clearance is more than 0.005 inch (0,13 mm) replace the bushing(s).

### Valve Removal

**NOTE:** Mark all components so they can be returned to the same position.

Figure 70-100-35

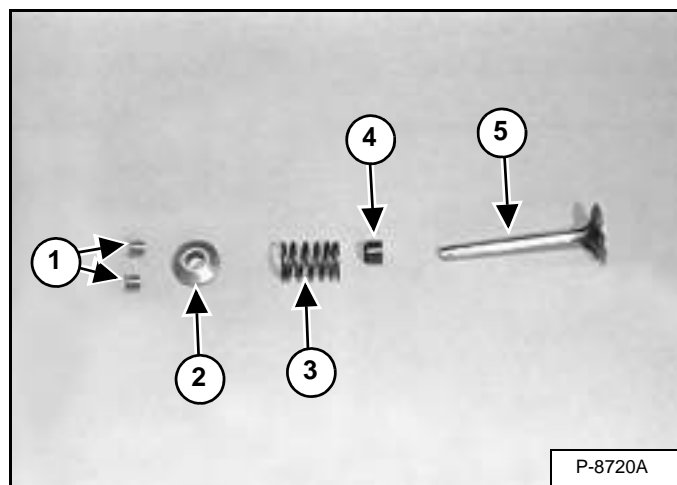

Using a valve spring compressor compress the springs and remove the retainers (Item 1) [Figure 70-100-35].

Release the compressor and remove the valve spring cap (Item 2), spring (Item 3), valve seal / spring seat washer (Item 4) and valve (Item 5) [Figure 70-100-35].

Clean and inspect all components.

## RECONDITIONING THE ENGINE (CONT'D)

### Valve Springs Checking

Figure 70-100-36

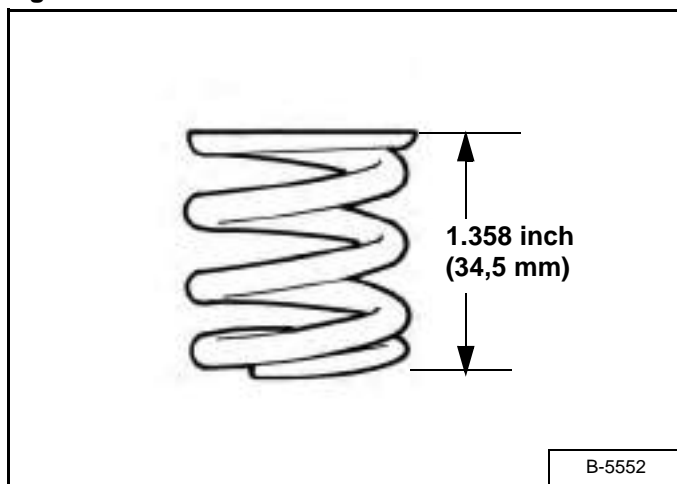

Use the following chart [Figure 70-100-36].

Valve Springs	
Compressed Height	1.358 inch (34,5 mm)
Installed Pressure	51 ft.-lbs. (229 N)

### Valve Depth Checking

Figure 70-100-37



Check the valve depth as shown in [Figure 70-100-37].

The maximum depth is 0.081 inch (2,06 mm) for both intake and exhaust valves.

If the valve is below the limits, install a new valve and recheck the valve depth. If it is still below limits a new valve seat insert must be installed.

When the depth is less than 0.060-0.071 inch (1,53-1,81 mm) the seat may be ground to lower the valve depth.

## RECONDITIONING THE ENGINE (CONT'D)

### Valve Guides Checking

Figure 70-100-38

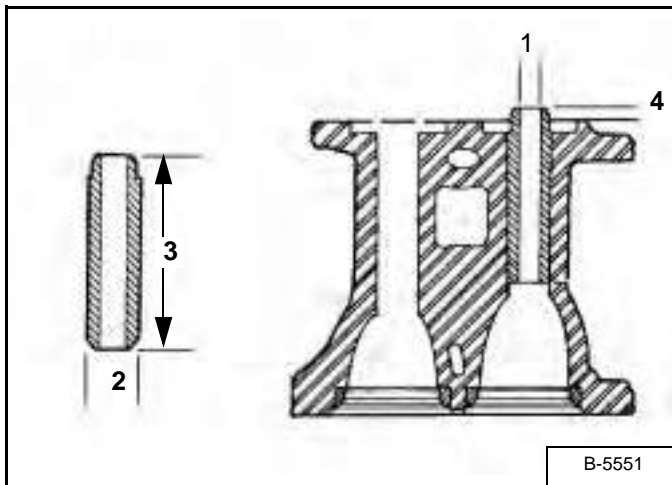

Intake & Exhaust	2.008-2.028 inch (51,00-51,50 mm)
------------------	--------------------------------------

Protrusion from bottom recess for valve spring; (Item 4) [Figure 70-100-38]	0.486-0.498 inch (12,35-12,65 mm)
--	--------------------------------------

To check the valve guides for wear using a valve.

Set up dial indicator gauge (Item 1) [Figure 70-100-38] as shown.

Lift the valve (Item 2) 0.60 inches (15,0 mm) and move the valve in and away from the gauge (Item 1) [Figure 70-100-38]. Record this reading.

If the clearance exceeds 0.009 inches (0,22 mm) for intake or 0.010 inches (25 mm) for exhaust (Item 3) [Figure 70-100-39] the valve guide needs to be replaced.

Figure 70-100-39

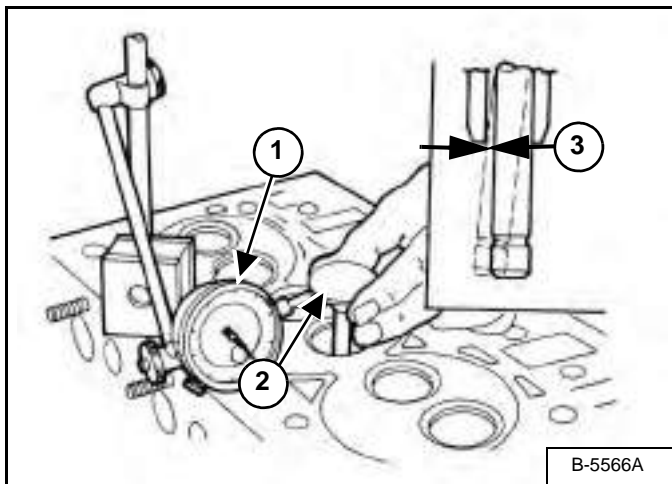

The valve guides can be checked for wear with either of the operations listed in [Figure 70-100-38] or [Figure 70-100-39].

Use the following chart to check valve guides.

Inside Diameter	
(Item 1) [Figure 70-100-38]	0.3543-0.3552 inch (9,00-9,02 mm)

Outside Diameter (Item 2) [Figure 70-100-38]	
Intake & Exhaust	0.5131-0.5137 inch (13,04-13,05 mm)

Interference fit of valve guide to cylinder head: 0.0003-0.0019 inch (0,007-0,047 mm)

Overall Diameter (Item 3) [Figure 70-100-38]	
--	--

## RECONDITIONING THE ENGINE (CONT'D)

### Valve Guide Removal

Clean the guide bore in the head.

Figure 70-100-40

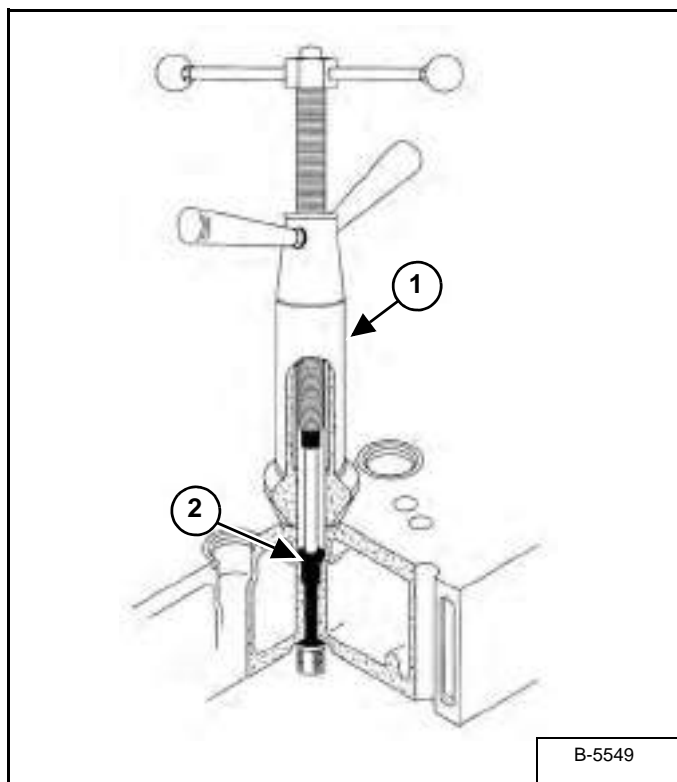

Install a valve guide removal / installation tool (Item 1) on the valve guide (Item 2) [Figure 70-100-40].

Pull the guide (Item 2) [Figure 70-100-40] out of the cylinder head.

### Valve Guide Installation

Figure 70-100-41

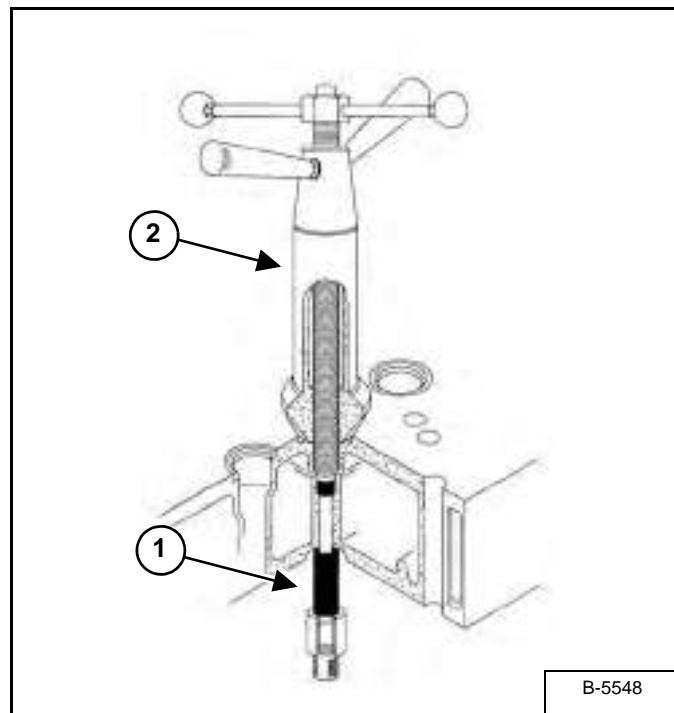

Clean the guide bore in the head.

Lubricate the outer surface of the new guide (Item 1) [Figure 70-100-41] with the engine oil.

Put the guide in position on the valve guide removal/ installation tool (Item 2) [Figure 70-100-41].

Pull the guide into the cylinder head.

When correctly positioned the top of the guide should extend 0.486-0.498 inch (12,35-12,65 mm) above the valve spring seat as shown on Page 70-100-13 [Figure 70-100-38].

## RECONDITIONING THE ENGINE (CONT'D)

### Valves Checking

**NOTE: If the valves do not meet specifications they need to be replaced. They cannot be ground.**

Figure 70-100-42

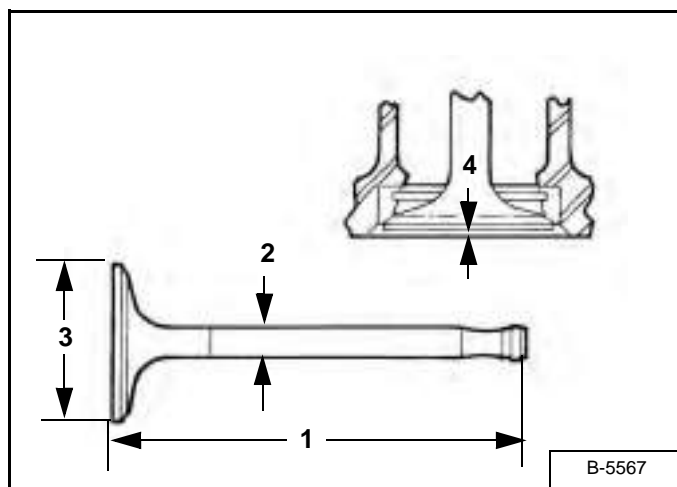

Use the following chart [Figure 70-100-42] to check the valve dimensions.

REF.	VALVE	SPECIFICATIONS
1.	Intake	5.076-5.093 inch (128,92-129,37 mm)
	Exhaust	5.075-5.093 inch (128,92-129,37 mm)
2.	Intake	0.3525-0.3533 inch (8,95-8,98 mm)
	Exhaust	0.3519-0.3528 inch (8,93-8,96 mm)
3.	Intake	1.819-1.829 inch (46,20-46,45 mm)
	Exhaust	1.634-1.644 inch (41,51-41,75 mm)
4.	Intake (Production)	0.062-0.072 inch (1,58-1,84 mm)
	Intake (Service Max.)	0.082 inch (2,09 mm)
	Exhaust (Production)	0.060-0.071 inch (5,53-1,81 mm)
	Exhaust (Service Max.)	0.081 inch (2,06 mm)
	Intake/Exhaust Valve Face Angle	30°

### Cutting A Valve Seat

Before any work is done the valve guides must meet specifications or have been replaced.

Install the pilot in the valve guide.

Select the correct size cutter.

Valve Seat Angle	30°
------------------	-----

Figure 70-100-43



Carefully turn the cutter in a clockwise direction using even downward pressure. Keep the valve seat as narrow as possible [Figure 70-100-43].

Remove any cutting debris.

Install the valve and lightly tap.

Check the valve depth to make sure that it is within limits (See "Valve Depth Checking" on page 70-100-12).

**NOTE: If the valve seat is worn or damaged, a new valve seat insert can be installed.**

## RECONDITIONING THE ENGINE (CONT'D)

### Valve Seat Assembly

# ! WARNING

Wear safety glasses to prevent eye injury when any of the following conditions exist:

- When fluids are under pressure.
- Flying debris or loose material is present.
- Engine is running.
- Tools are being used.

W-2019-1285

Figure 70-100-44

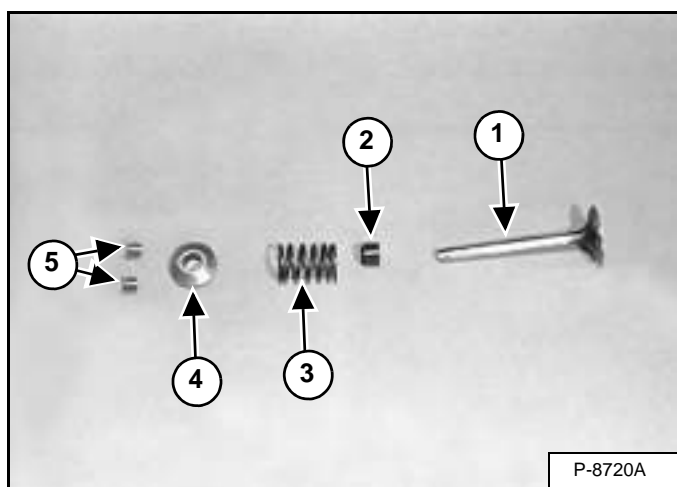

Lubricate the valve stems (Item 1) [Figure 70-100-44] with clean engine oil and install them in the respective guides.

Install new valve seals / spring seat washer (Item 2) [Figure 70-100-44].

Install the spring (Item 3) [Figure 70-100-44] on the washer (make sure the larger diameter is against the cylinder head).

Place the valve cap (Item 4) [Figure 70-100-44] on the spring.

Using a valve spring compressor compress the springs and install the retainers (Item 5) [Figure 70-100-44].

## RECONDITIONING THE ENGINE (CONT'D)

### Changing Valve Springs (With Cylinder Head Installed)

Remove the rocker cover.

**Figure 70-100-45**

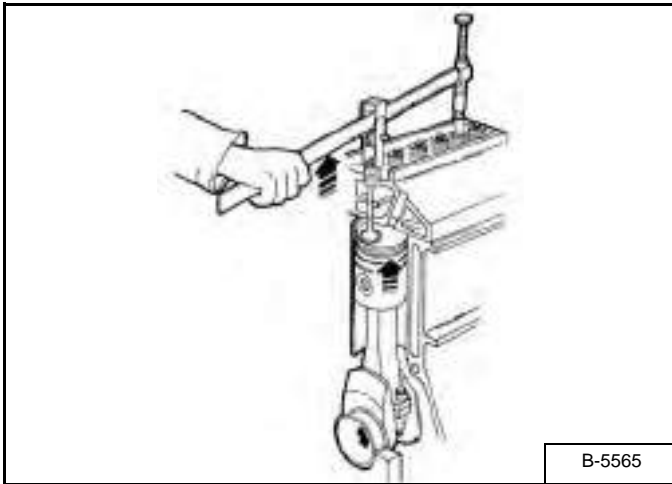

Rotate the crankshaft clockwise until the intake valve has opened and the exhaust valve has not fully closed. In this position the piston (Item 1) **[Figure 70-100-45]** will be at approximately T.D.C.

Remove the rocker shaft assembly.

**Figure 70-100-46**

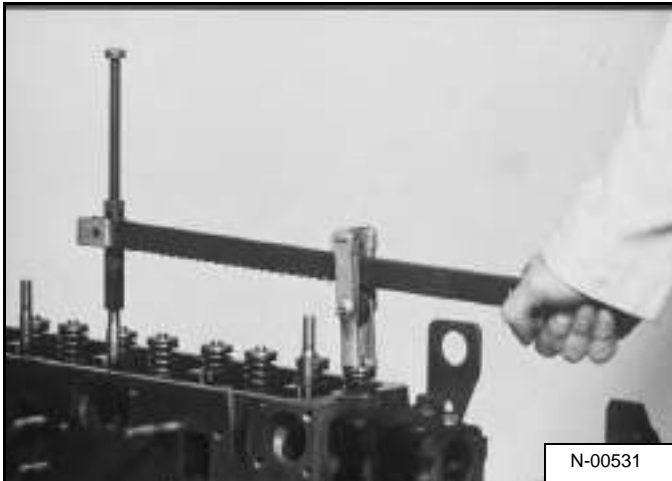

Install the valve spring compressor and adapter **[Figure 70-100-46]**.

Compress the valve springs squarely and remove the retainers.

**NOTE: Do not rotate the crankshaft while the valve springs are removed.**

Release the compressor and remove the valve spring(s).

Place the new valve springs in position.

Compress the valve springs and install the retainers.

## RECONDITIONING THE ENGINE (CONT'D)

### Valve Clearance Adjustment

Adjust the valve clearance as follows:

Figure 70-100-47

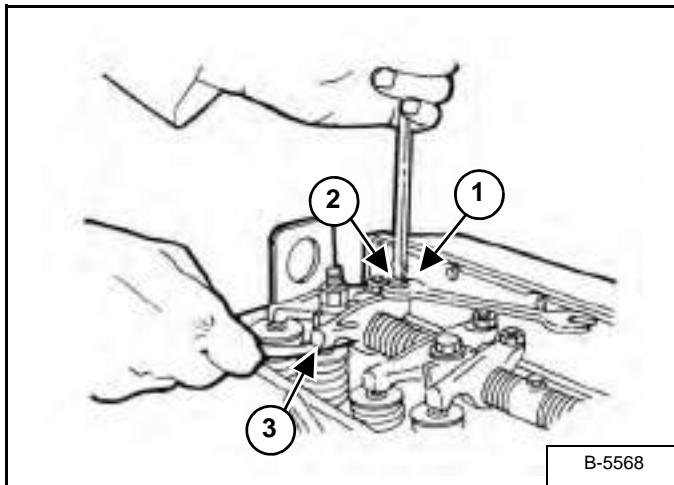

Loosen the lock nut (Item 1) [Figure 70-100-47].

Turn the adjustment screw (Item 2) [Figure 70-100-47] until the correct clearance is obtained.

**NOTE: The clearance is measured between the rocker arm and valve stem tip (Item 3) [Figure 70-100-47].**

Adjust the valve clearance as follows:

0.008 inch (0,20 mm)	Intake
0.018 inch (0,45 mm)	Exhaust

Figure 70-100-48

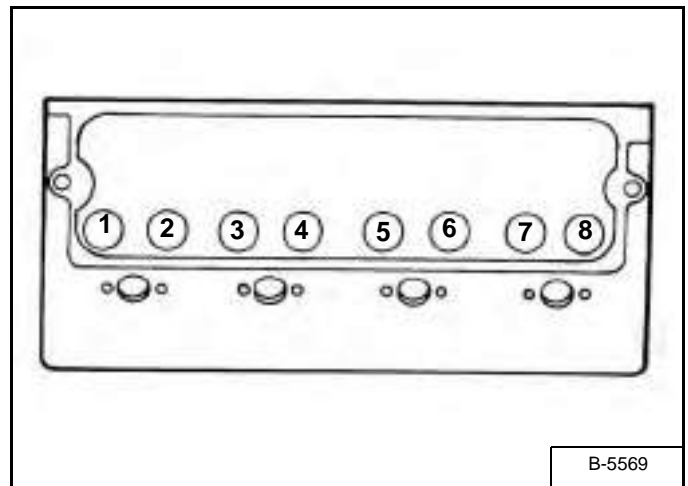

Figure 70-100-49

Cylinder No.	1		2		3		4	
Valve No.	1	2	3	4	5	6	7	8
Valve 1=Intake E=Exhaust	I	E	I	E	I	E	I	E

Use the following sequence to set the valves [Figure 70-100-48] & [Figure 70-100-49].

a.	With the rocker arm rocking (valves 7 & 8) on No. 4 cylinder set clearance at No. 1 cylinder (valves 1 & 2).
b.	With the rocker arm rocking (valves 3 & 4) on No. 2 cylinder set clearance at No. 3 cylinder (valves 5 & 6).
c.	With the rocker arm rocking (valves 1 & 2) on No. 1 cylinder set clearance at No. 4 cylinder (valves 7 & 8).
d.	With the rocker arm rocking (valves 5 & 6) on No. 3 cylinder set clearance at No. 2 cylinder (valves 3 & 4).



## RECONDITIONING THE ENGINE (CONT'D)

### Timing Case And Drive Assembly Description

The timing case is made of aluminum and the cover is made of tin and in most applications, the timing gears are made of steel. The drive from the crankshaft passes to the idler gear, to the camshaft gear, to the gear on the fuel injection pump and to the water pump.

The camshaft and fuel injection pump run at half the speed of the crankshaft.

### Timing Cover Removal

Remove the water pump (See "Water Pump Removal" on page 70-100-39).

Figure 70-100-50

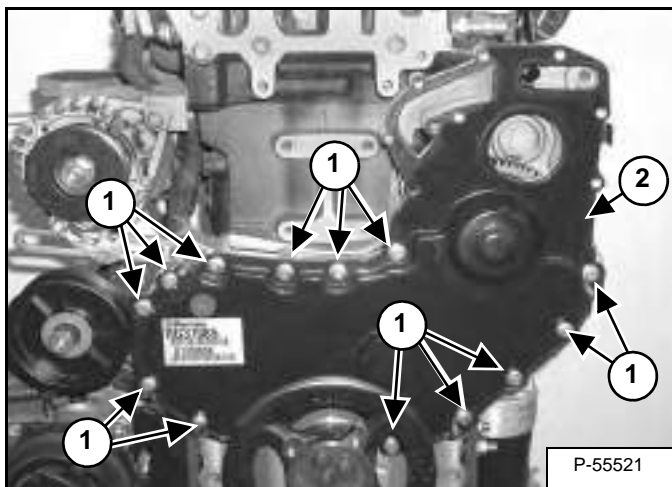

Remove the timing cover bolts (Item 1) and remove the timing cover (Item 2) [Figure 70-100-50].

### Timing Cover Installation

Clean the gasket mating surfaces.

Place the gasket and timing cover on the engine.

Remove the timing pins if fitted.

Hold the timing cover in position and install two bolts that are on opposite sides of the cover. Do not tighten the bolts.

Install the water pump (See "Water Pump Installation" on page 70-100-39).

Do not tighten bolts at this time.

Tighten the cover bolts and water pump bolts to 16 ft.-lb. (22 N•m) torque.

## Crankshaft Pulley Removal And Installation

Figure 70-100-51

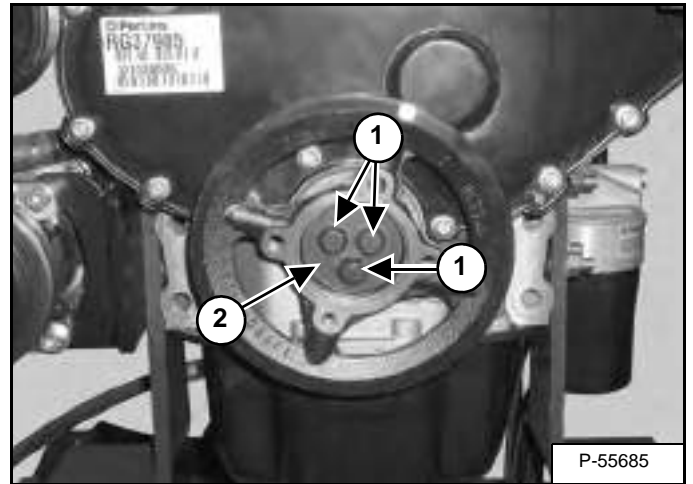

Remove the three bolts (Item 1) and thrust block (Item 2) [Figure 70-100-51].

**Installation:** Tighten the bolts to 85 ft.-lb. (115 N•m) torque.

Remove the pulley.

### Front Oil Seal Removal And Installation

Remove the crankshaft pulley (See "Crankshaft Pulley Removal And Installation" on page 70-100-19).

Remove the oil seal using a seal removal tool.

Do not damage the edge of the seal housing.

Figure 70-100-52

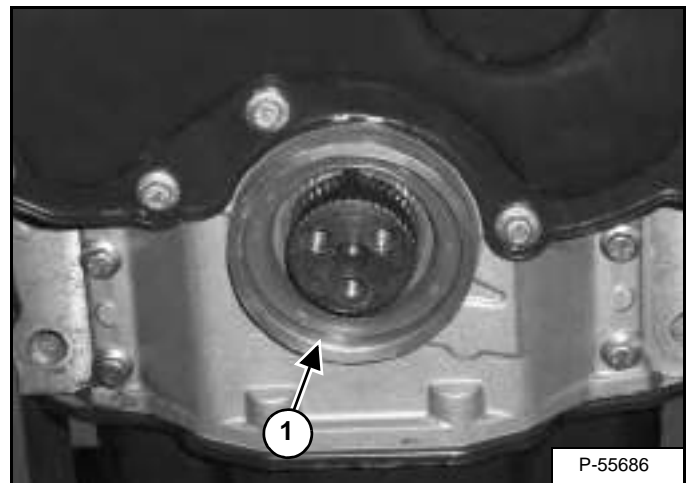

Install the oil seal (Item 1) [Figure 70-100-52] into the housing using the special tool.

Install crankshaft pulley (See "Crankshaft Pulley Removal And Installation" on page 70-100-19).

## RECONDITIONING THE ENGINE (CONT'D)

### Timing Case And Gear Removal

Remove the timing cover (See "Timing Cover Removal" on page 70-100-19).

Remove the crankshaft pulley (See "Crankshaft Pulley Removal And Installation" on page 70-100-19).

Remove the fuel injection pump (See "Fuel Injection Pump Removal" on page 70-70-1.)

Figure 70-100-53

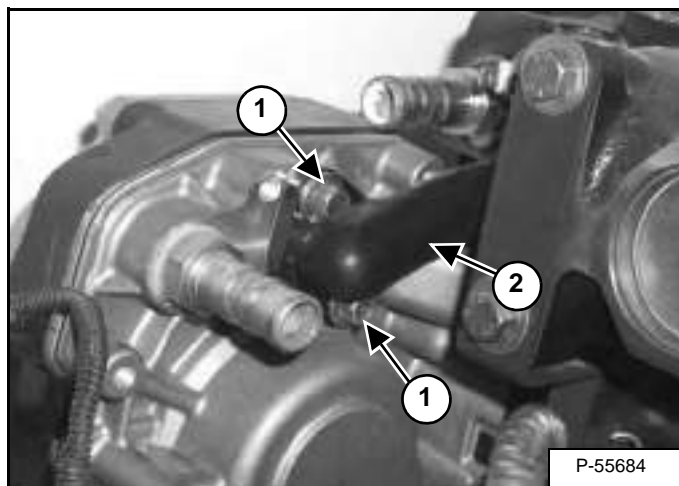

Remove the two bolts (Item 1) and remove the coolant bypass tube (Item 2) [Figure 70-100-53].

Figure 70-100-54

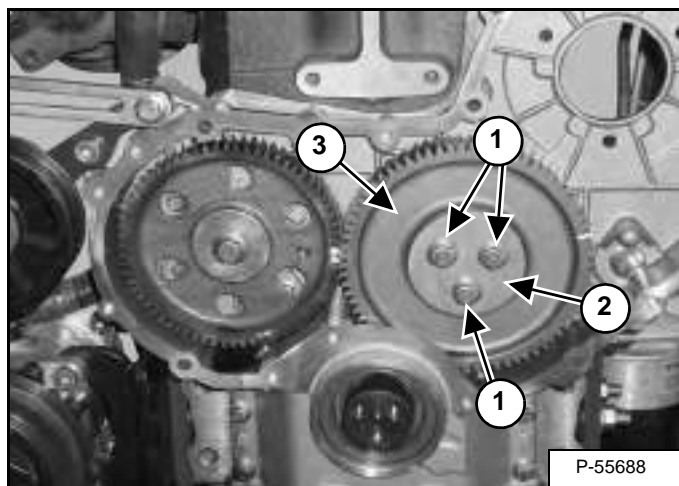

Remove the three bolts (Item 1) and plate (Item 2) from the idler gear (Item 3) [Figure 70-100-54].

Figure 70-100-55

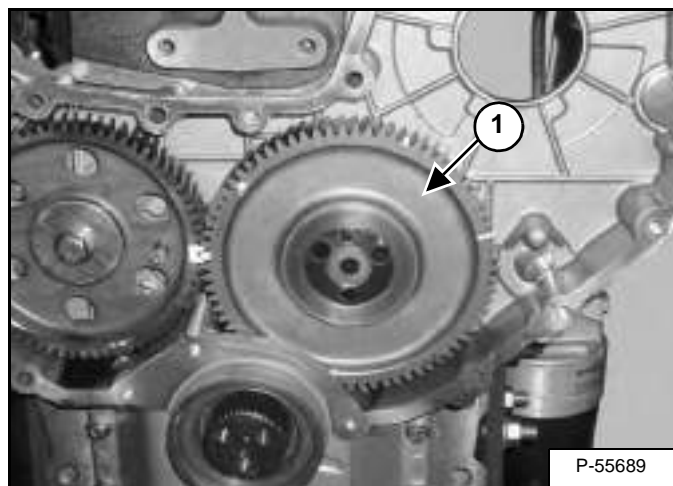

Remove the idler gear (Item 1) [Figure 70-100-55] by moving the gear assembly forward and lifted over the front oil seal housing.

**NOTE:** Do not turn the crankshaft with the idler gear removed.

Figure 70-100-56

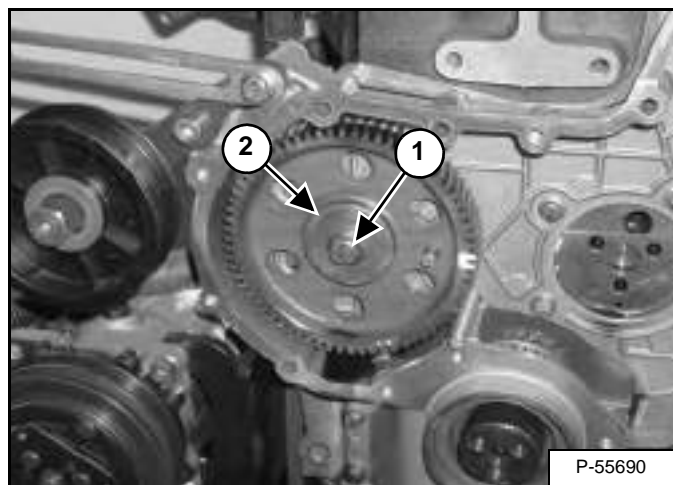

Remove the bolt (Item 1) and washer (Item 2) [Figure 70-100-56].

## RECONDITIONING THE ENGINE (CONT'D)

### Timing Case And Gear Removal (Cont'd)

Figure 70-100-57

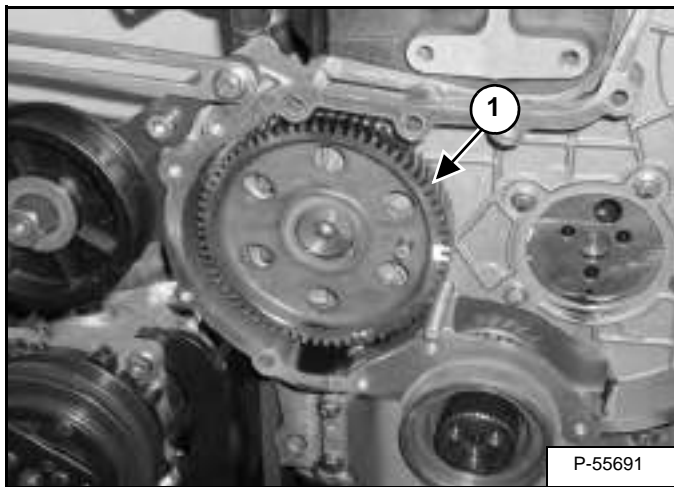

Remove the camshaft gear (Item 1) [Figure 70-100-57].

**NOTE:** Use care not to lose the key from the key way.

Figure 70-100-58

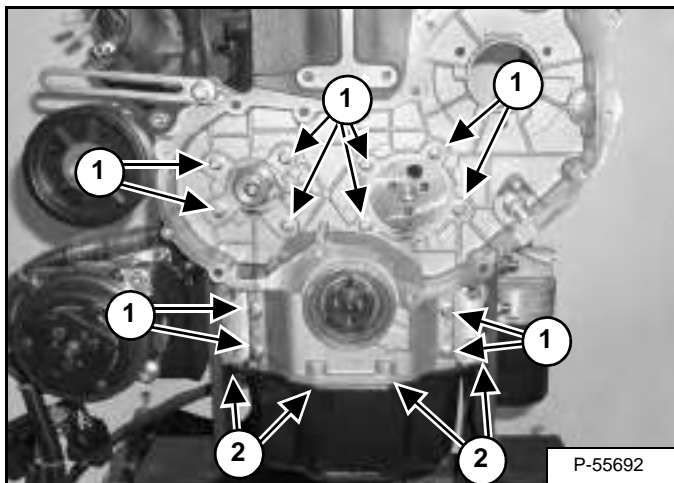

Remove all the timing case mount bolts (Item 1) and the four bolts (Item 2) [Figure 70-100-58] from the front of the oil pan.

Remove the timing case from the engine.

### Timing Case And Gear Installation

Clean the mating surfaces, if the oil pan was not removed trim the oil gasket flush with the block.

Figure 70-100-59

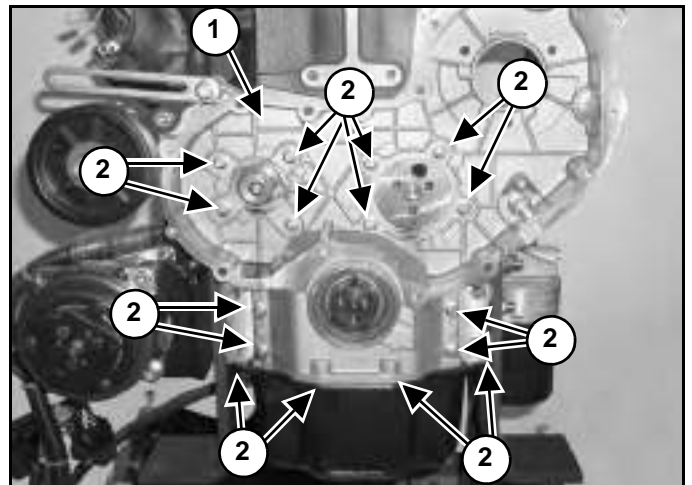

Fit the timing case (Item 1) onto the cylinder block and hand tighten the bolts (Item 2) [Figure 70-100-59].

After the cover is correctly aligned, tighten the mount bolts (Item 2) [Figure 70-100-59] to 16 ft.-lb. (22 N•m) torque.

Figure 70-100-60

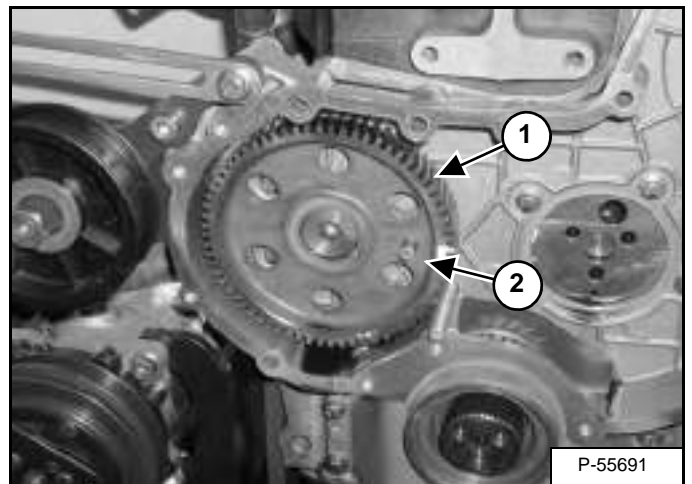

Install the camshaft gear (Item 1) onto the shaft using alignment pin (Item 2) [Figure 70-100-60] for correct alignment.

## RECONDITIONING THE ENGINE (CONT'D)

### Timing Case And Gear Installation (Cont'd)

Figure 70-100-61

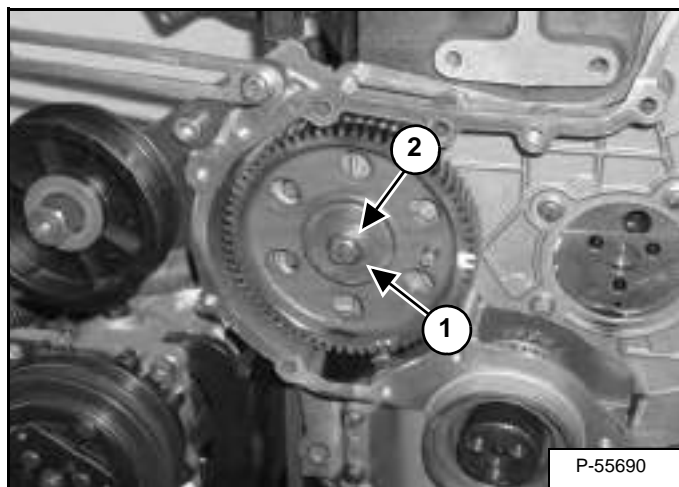

Install the washer (Item 1) and bolt (Item 2) [Figure 70-100-61] and tighten to 70 ft.-lb. (95 N•m) torque.

Figure 70-100-62

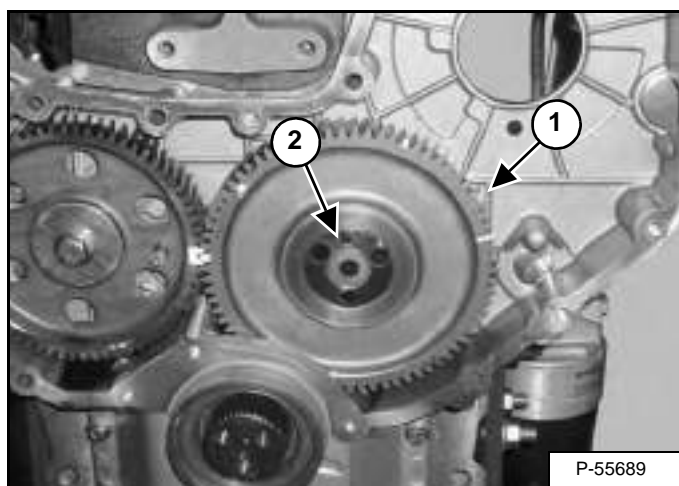

Install the idler gear (Item 1) make sure the hole (Item 2) [Figure 70-100-62] is towards the cylinder head.

Figure 70-100-63

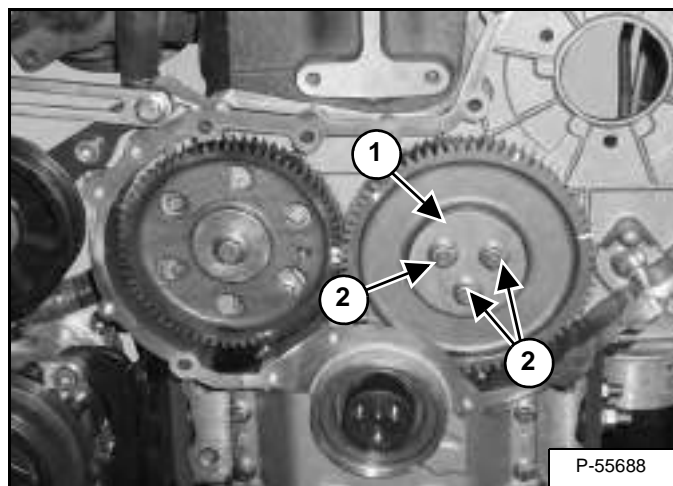

Install the plate (Item 1) and three bolts (Item 2) [Figure 70-100-63].

Tighten the bolts to 33 ft.- lb. (44 N•m) torque.

Figure 70-100-64

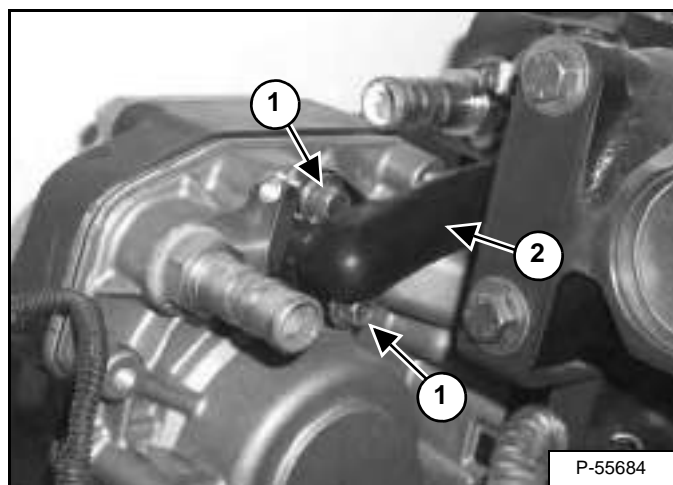

Install the coolant by-pass tube (Item 1) using the two bolts (Item 2) [Figure 70-100-64].

Install the fuel injection pump (See "Fuel Injection Pump Installation" on page 70-70-4).

Install the crankshaft pulley (See "Crankshaft Pulley Removal And Installation" on page 70-100-19).

Install the timing cover (See "Timing Cover Installation" on page 70-100-19).

## RECONDITIONING THE ENGINE (CONT'D)

### Camshaft And Tappets Removal

Remove the timing case cover (See "Timing Cover Installation" on page 70-100-19).

Remove the fuel injection pump (See "Fuel Injection Pump Removal" on page 70-70-1).

Remove the timing case (See "Timing Case And Gear Removal" on page 70-100-20).

Remove the rocker cover, rocker assembly and push rods (See "Rocker Cover Removal And Installation" on page 70-100-5).

Remove the fuel pump and gasket.

**Figure 70-100-65**

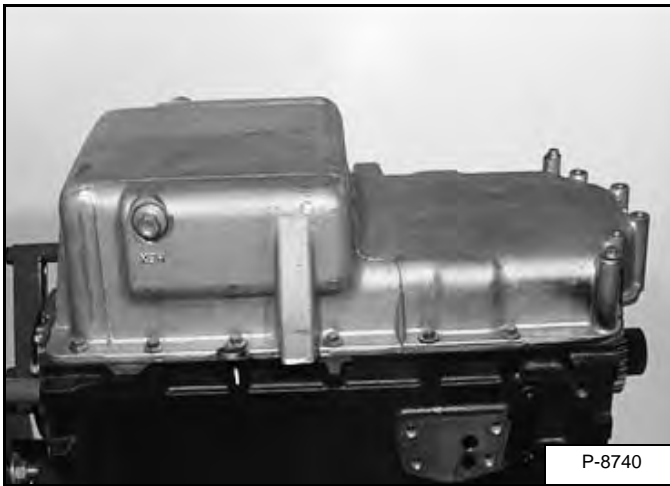

Turn the engine over and remove the oil pan mounting bolts [Figure 70-100-65].

Remove the oil pan and gasket.

**Installation:** Tighten the oil pan mounting bolts to 16 ft.-lb. (22 N•m) torque.

**Figure 70-100-66**

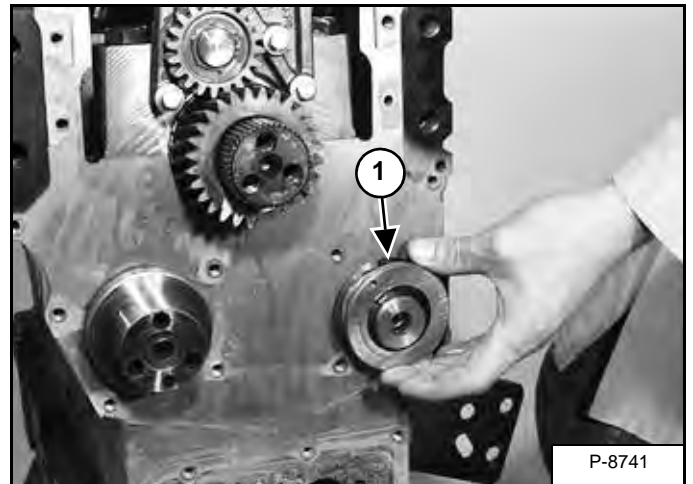

Remove the camshaft thrust washer (Item 1) [Figure 70-100-66].

**Figure 70-100-67**

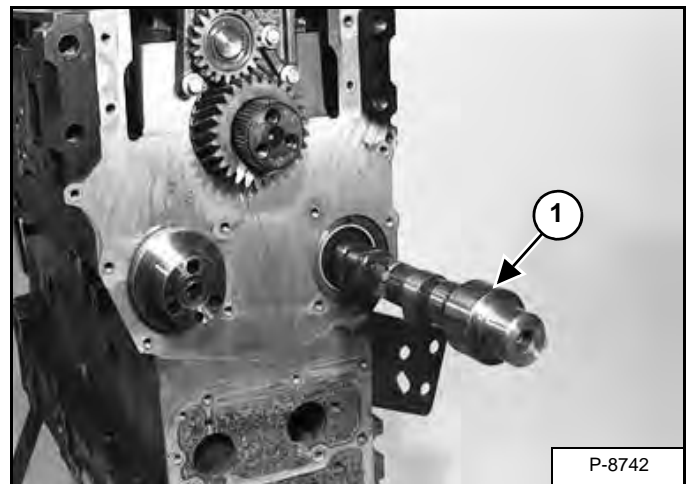

Carefully remove the camshaft (Item 1) [Figure 70-100-67].

## RECONDITIONING THE ENGINE (CONT'D)

### Camshaft And Tappets Removal (Cont'd)

Figure 70-100-68

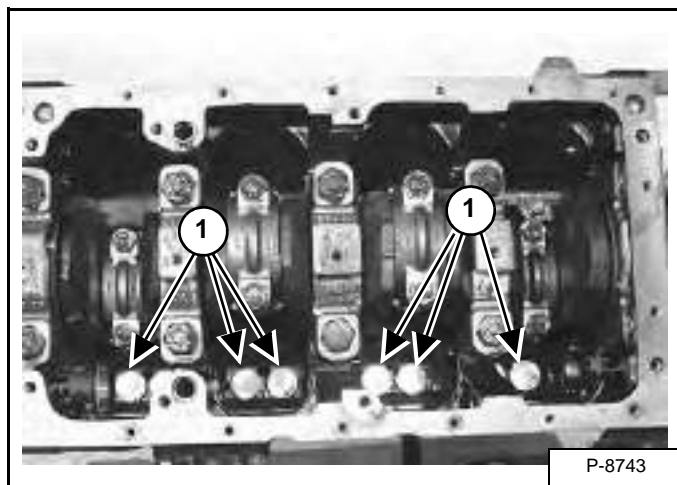

Remove the tappets (Item 1) [Figure 70-100-68] from the block.

### Camshaft And Tappets Installation

Clean and inspect the camshaft and tappets for excessive wear and damage.

Inspect the camshaft bushing for excessive wear and damage.

**NOTE: Only the front camshaft journal bore has a bushing.**

Clearance between the camshaft journals, the bushing and camshaft bore is 0.0025 - 0.0055 inch (0,06 - 0,14 mm).

Make sure all components are clean and lubricated with clean engine oil.

Figure 70-100-69

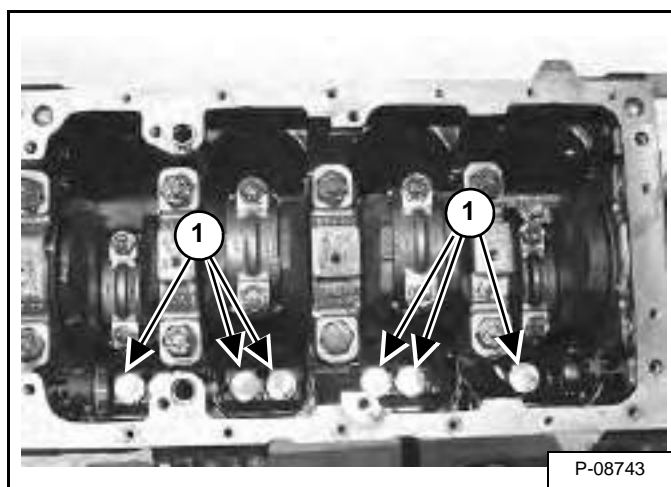

Install the tappets (Item 1) [Figure 70-100-69].

Figure 70-100-70

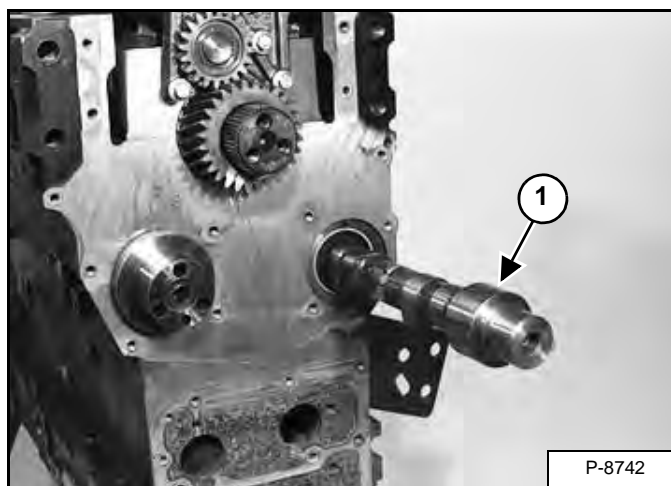

Carefully install the camshaft (Item 1) [Figure 70-100-70].

## RECONDITIONING THE ENGINE (CONT'D)

### Camshaft And Tappets Installation (Cont'd)

Figure 70-100-71

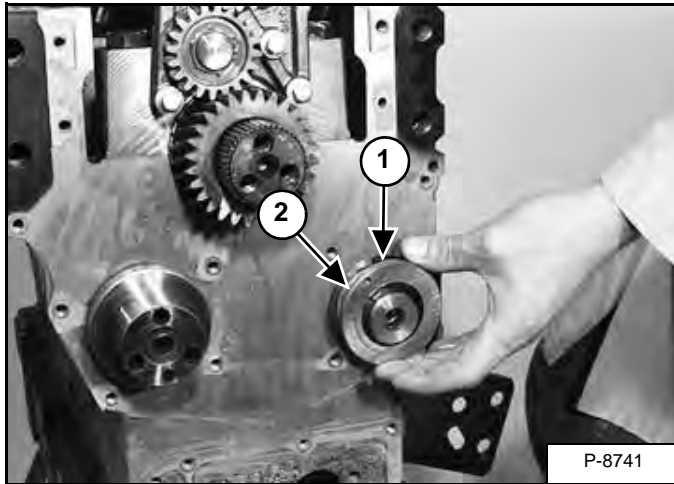

Install the camshaft thrust washer (Item 1). Make sure that the dowel pin (Item 2) **[Figure 70-100-71]** lines up with the hole in the thrust washer.

Install the timing case (See "Timing Case And Gear Installation" on page 70-100-21).

Check camshaft end play. The end play for a new engine is 0.004 - 0.022 inch (0,10 - 0,55 mm), service limits 0.023 inch (0,60 mm).

Install the timing gears (See "Timing Case And Gear Installation" on page 70-100-21).

Install the injection pump (See "Fuel Injection Pump Installation" on page 70-70-4).

Install the push rods and rocker assembly (See page 70-100-11.)

Install the timing cover (See "Timing Cover Installation" on page 70-100-19).

Install the oil pan (See "Oil Pan Removal And Installation" on page 70-100-41).

### Pistons And Connecting Rods Description

The pistons have a Quadram combustion chamber. They have two compression rings and one oil control ring. The top ring groove has a hard metal insert to reduce wear. Full floating piston pins are used and are retained by snap rings.

Controlled expansion pistons have a steel insert ring in the piston skirt. The connecting rods are molybdenum steel. The connecting rods on the turbocharged engines have wedge shaped small ends. The location of the bearing caps to the connecting rods is made by serrations and the cap is retained by two bolts.

The pistons used in the 1000 series engines have two compression rings and one oil control ring. All the rings are above the piston pin. Each of the three piston rings have different design features. Always use the engine identification number to order new parts.

### Pistons And Connecting Rods Removal

Figure 70-100-72

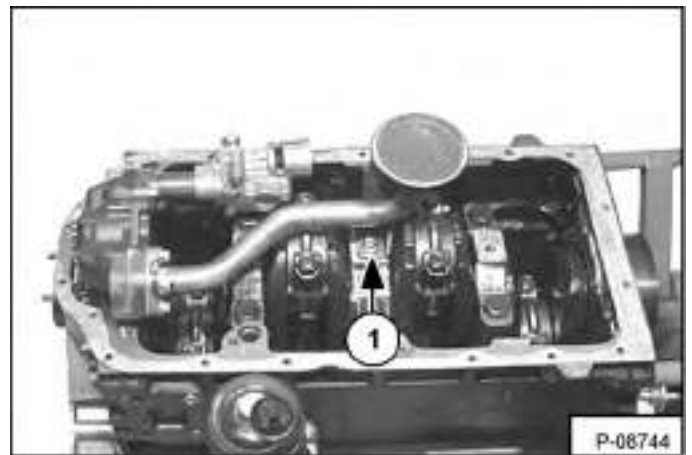

Remove the cylinder head (See "Cylinder Head Removal" on page 70-100-6.)

Remove all the carbon from the top of the cylinder liners.

Remove the oil pan (See "Oil Pan Removal And Installation" on page 70-100-41.)

Remove the oil pick up screen and tube (Item 1) **[Figure 70-100-72]**.



## RECONDITIONING THE ENGINE (CONT'D)

### Pistons And Connecting Rods Removal (Cont'd)

Figure 70-100-73

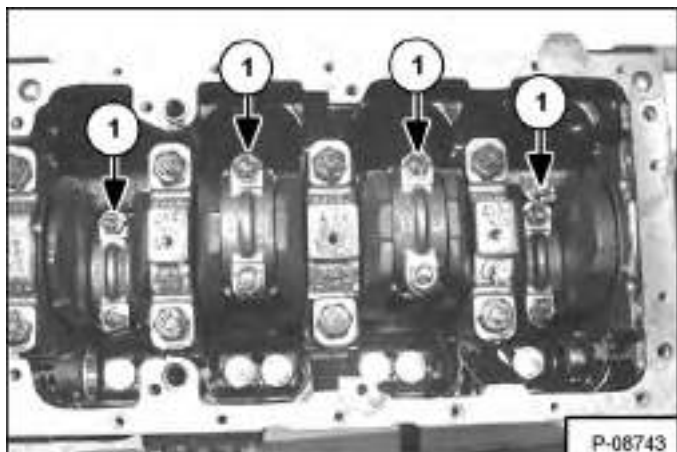

Mark and remove the connecting rod caps (Item 1) [Figure 70-100-73].

**NOTE:** Do not allow the connecting rods to hit the cooling jets.

Figure 70-100-74

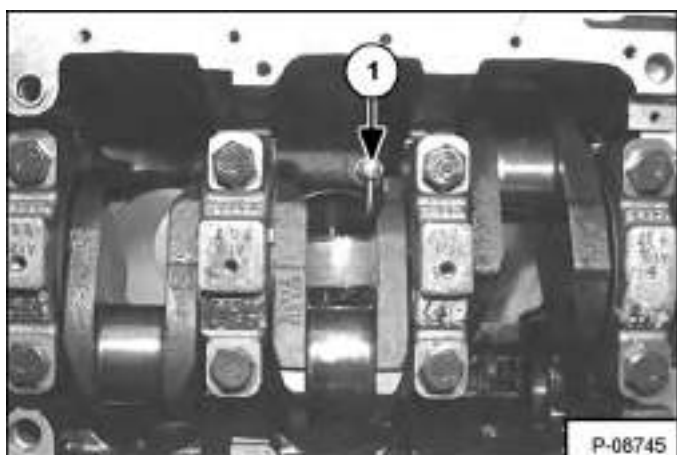

Turn the connecting rods 90° to prevent contact with the piston cooling jets (Item 1) [Figure 70-100-74]. Push the piston and rod assemblies out the top of the cylinder.

Figure 70-100-75

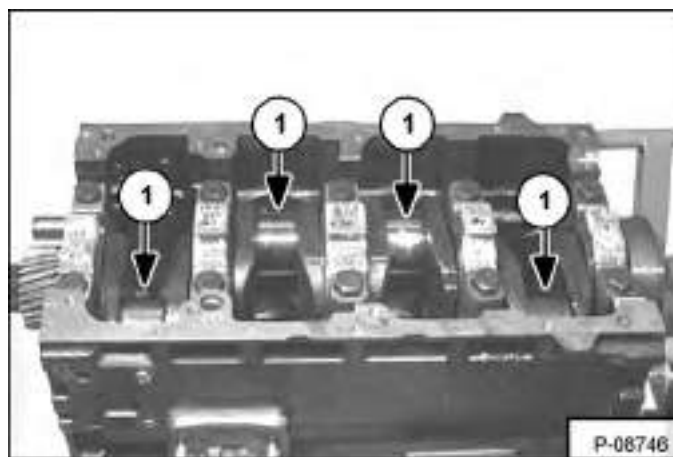

Inspect the crankshaft journals (Item 1) [Figure 70-100-75] for wear or damage.

**NOTE:** Keep all parts together so they can be replaced in their original position.

**NOTE:** Before installing the pistons check cylinder bore for wear or damage (See "Cylinder Liner Inspection" on page 70-100-47.)



## RECONDITIONING THE ENGINE (CONT'D)

### Pistons And Connecting Rods Disassembly

Figure 70-100-76

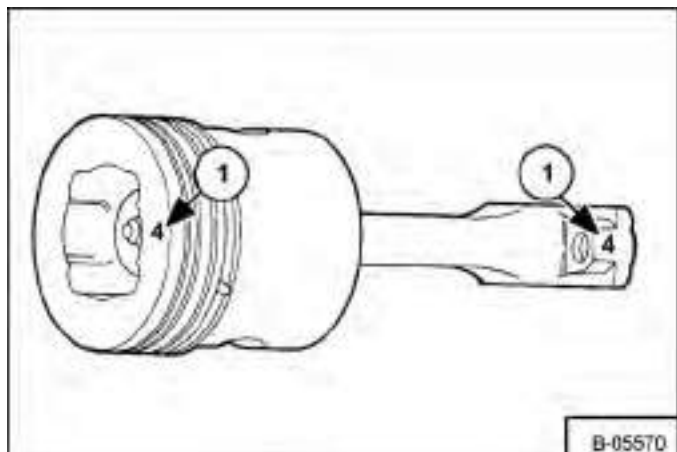

Mark the piston to indicate the cylinder number (Item 1) [Figure 70-100-76] as shown on the connecting rod.

Figure 70-100-77

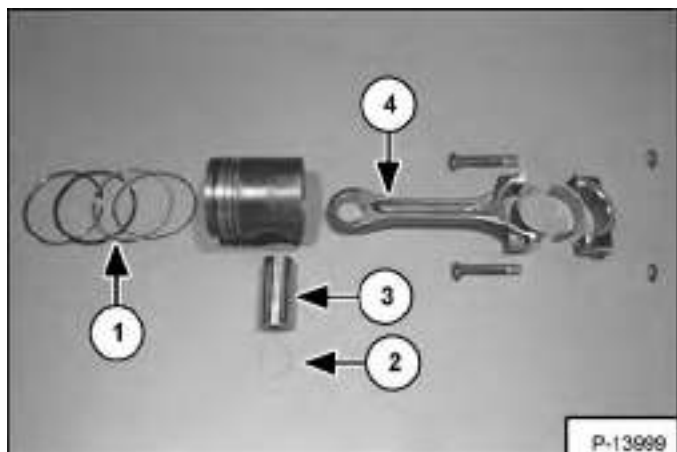

Remove the piston rings (Item 1) [Figure 70-100-77] with a ring expander.

Remove the snap rings (Item 2) [Figure 70-100-77] which retain the piston pin.

Push the piston pin (Item 3) [Figure 70-100-77] out by hand. If the pin doesn't push out easily, heat the piston to 100°-120° F (40°-50° C) for easier removal.

Remove the connecting rod (Item 4) [Figure 70-100-77].

### Piston Ring End Gap

Figure 70-100-78

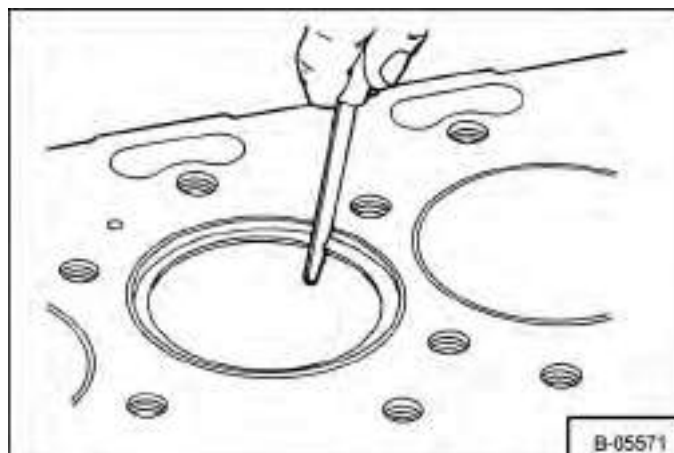

Place the piston rings in the upper part of the cylinder to check the end gap [Figure 70-100-78].

Top Ring End Gap	0.0118-0.0216 inch (0,30-0,55 mm)
Second Ring End Gap	0.0275-0.0374 inch (0,70-0,95 mm)
Third Ring End Gap	0.0118-0.0216 inch (0,30-0,55 mm)

### Piston Ring Installation

Figure 70-100-79

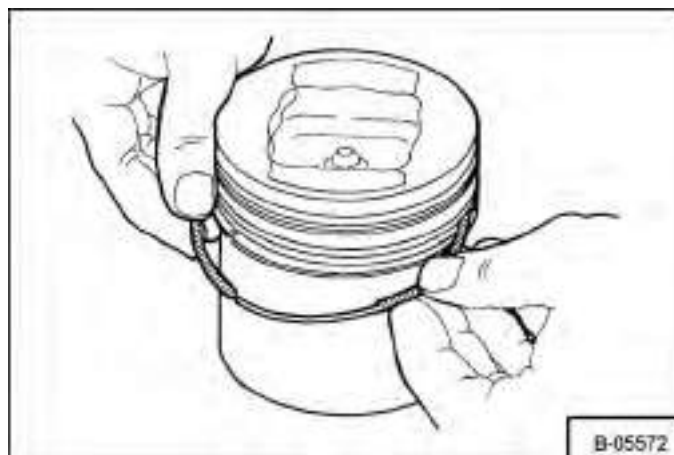

Install the spring of the oil control ring in the bottom groove with the latch pin inside both ends of the spring [Figure 70-100-79].

## RECONDITIONING THE ENGINE (CONT'D)

### Piston Ring Installation (Cont'd)

Use a ring expander to install the piston rings.

Install the oil spring on the bottom groove of the piston with the latch pin inside both ends of the spring.

**Figure 70-100-80**

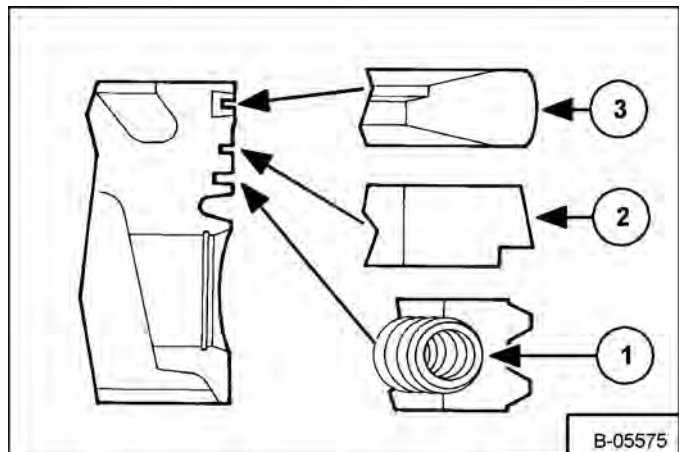

Install the oil control ring over the spring (Item 1) **[Figure 70-100-80]**.

Make sure the ring gap is 180° from the latch pin.

Install the cast iron ring with the tapered face (Item 2) **[Figure 70-100-80]** in the second groove with the word *TOP* or symbol facing the top of the piston.

New second rings have a green identification mark, which must be on the left of the ring gap after the ring is installed and the piston is upright.

The second ring has an external step at the bottom of the tapered face.

Place the chromium ring (Item 3) **[Figure 70-100-80]** with the symbol or word *TOP* up when installed on the piston.

The top ring (Item 3) **[Figure 70-100-80]** has an internal step.

New top rings have a red or blue identification mark, which must be on the left of the ring gap after the ring is installed and the piston is uptight.

Make sure the ring gaps are 120° apart.

### Piston Ring Groove Clearance

**Figure 70-100-81**



With the piston rings installed, check the groove clearance **[Figure 70-100-81]**.

Top Ring	Wedge
Second Ring Side Clearance	0.002 - 0.003 inch (0,05 - 0,09 mm)
Third Ring Side Clearance	0.0011 - 0.0029 inch (0,03 - 0,07 mm)

## RECONDITIONING THE ENGINE (CONT'D)

### Connecting Rod Inspection

Figure 70-100-82

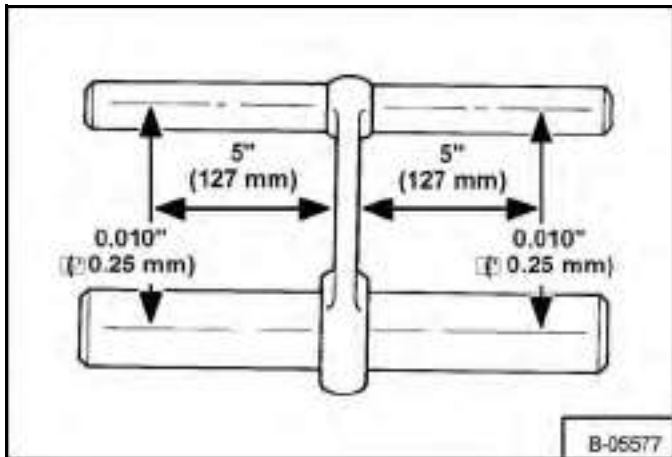

Checking the connecting rod for distortion [Figure 70-100-82].

**NOTE: The large and small end bores must be square and parallel within the limits of  $\pm 0.010$  inch (0,25 mm).**

Measure this 5.0 inch (127 mm) on each side of the connecting rod axis on a test fixture.

With the piston pin bushing installed the limit is reduced to  $\pm 0.0025$  inch (0,06 mm).

Check the pin bushing for wear or damage. Replace as needed.

### Connecting Rod Bushing Replacement

Press out the old bushing. Clean the bore and remove any burrs.

Press in the new bushing making sure the oil feed holes line up.

Ream the bushing to get the proper clearance of 0.0009 - 0.0017 inch (0,023 - 0,044 mm) between the small end bushing and piston pin.

## Piston And Connecting Rod Assembly

Figure 70-100-83

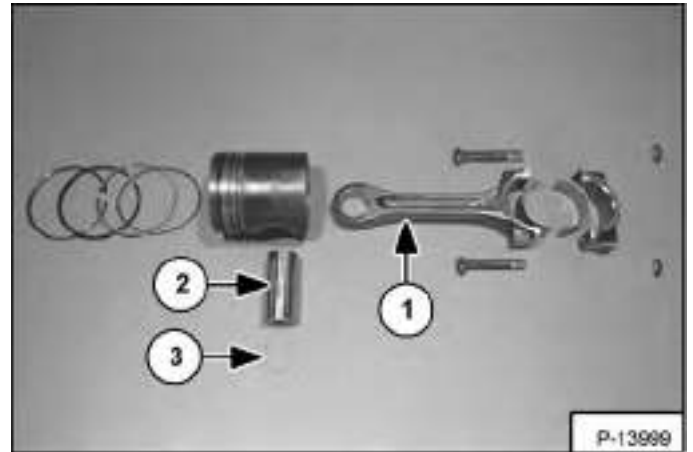

Install the connecting rod (Item 1), piston pin (Item 2) and two snap rings (Item 3) [Figure 70-100-83] in the piston.

### Piston And Connecting Rod Installation

Apply a light coat of oil to the piston and piston rings.

**NOTE: Make sure the piston ring end gaps are 120° apart.**

Figure 70-100-84

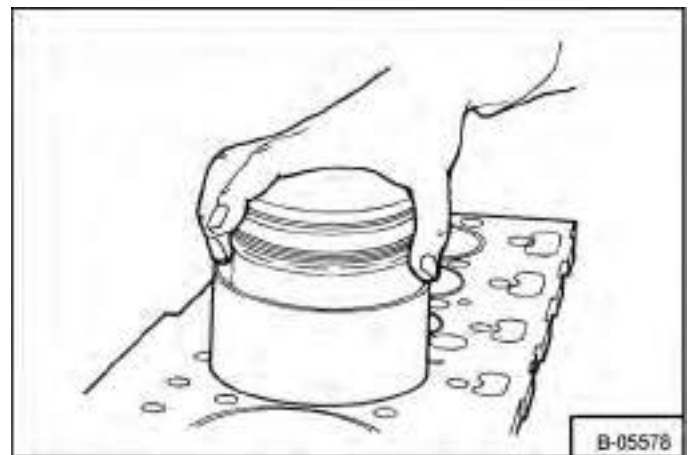

Install the ring compressor over the piston rings [Figure 70-100-84].

Carefully place the connecting rod in the cylinder and using a hammer handle, push the piston in the bore.

## RECONDITIONING THE ENGINE (CONT'D)

### Piston And Connecting Rod Installation (Cont'd)

Figure 70-100-85

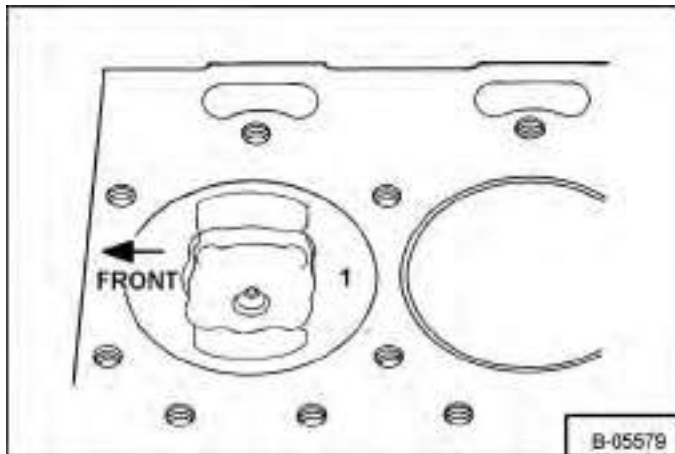

When the piston has cleared the cooling jet, rotate the piston assembly so that the arrow or *FRONT* mark is toward the front of the engine [Figure 70-100-85].

Figure 70-100-86

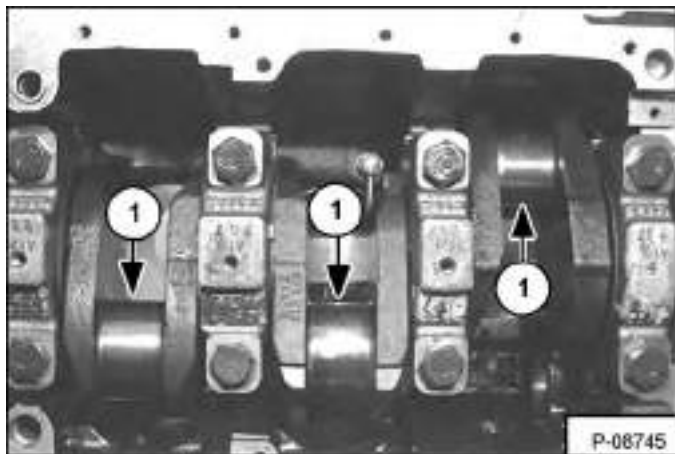

Clean the bearing surfaces and crank pin. Lubricate the crank pin (Item 1) [Figure 70-100-86] with clean engine oil.

Figure 70-100-87

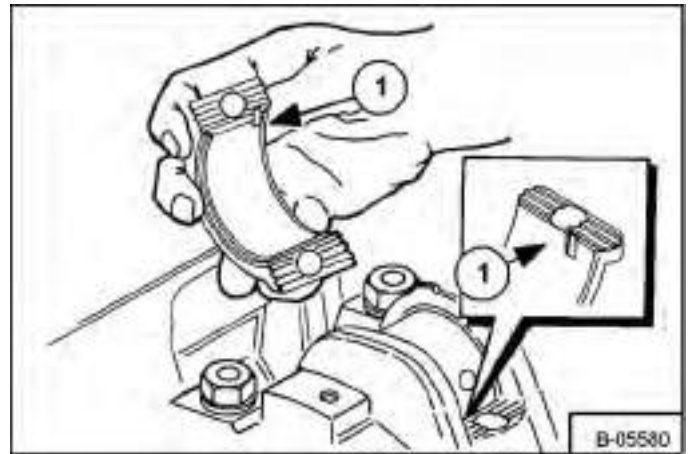

Install the upper and lower bearing shells in position making sure the locating tang (Item 1) [Figure 70-100-87] is in the correct position.

**NOTE:** New connecting rod nuts must be installed each time the rod caps are removed.

Figure 70-100-88

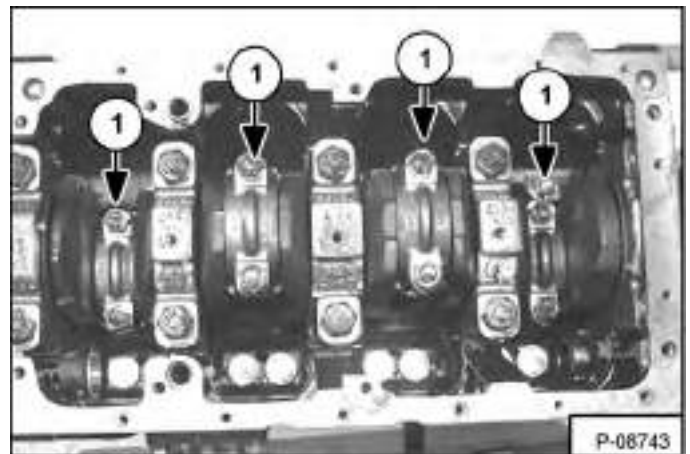

Install the caps (Item 1) [Figure 70-100-88] and nuts. Gradually tighten the nuts to 13 ft.-lb. (18 N•m) torque. Tighten to a final torque of 52 ft.-lb. (70 N•m). The fasteners must be tightened a further 120°.

Rotate the crankshaft. The crankshaft must rotate smoothly.

## RECONDITIONING THE ENGINE (CONT'D)

### Piston And Connecting Rod Installation (Cont'd)

Figure 70-100-89

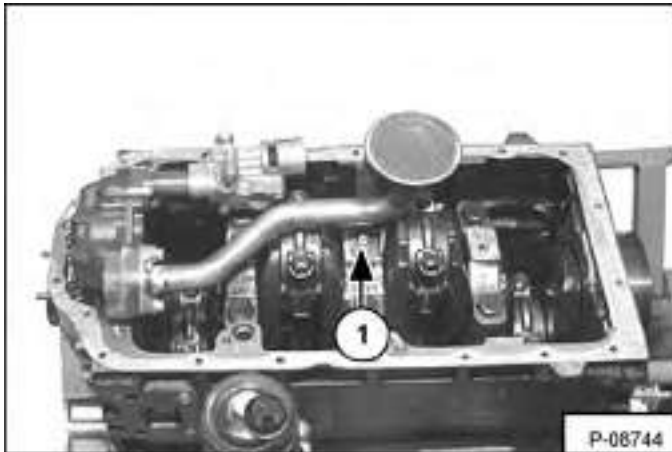

Install the oil pick up tube and screen (Item 1) [Figure 70-100-89].

Install the oil pan. (See Page 70-100-41.)

### Checking Piston Height

Rotate the crankshaft until the piston is approximately at top dead center (T.D.C.).

Using a dial indication gauge, pre-load the plunger on the top surface of the block and zero the gauge.

Carefully move the dial gauge so that the plunger is on top of the piston above the axis of the piston pin.

Rotate the crankshaft to bring the piston to it's highest point. Record this gauge reading.

When installed, the top surface of the piston is slightly above the surface of the cylinder block.

The height above the surface of the block should be 0.008 to 0.014 inch (0,21 to 0,35 mm).

Install the cylinder head (See "Cylinder Head Installation" on page 70-100-8).

### Crankshaft And Bearings Description

The crankshaft is a chrome-moly forging which has five main journals. End play is controlled by two half thrust washers on both sides of the center main bearing.

The main bearings have steel backs with a aluminium/ tin bearing material. The main bearing caps are made of cast iron.

The front and rear oil seals are viton lip seals with a dust lip to the outside of the main lip.

### Crankshaft And Bearings Removal

Figure 70-100-90

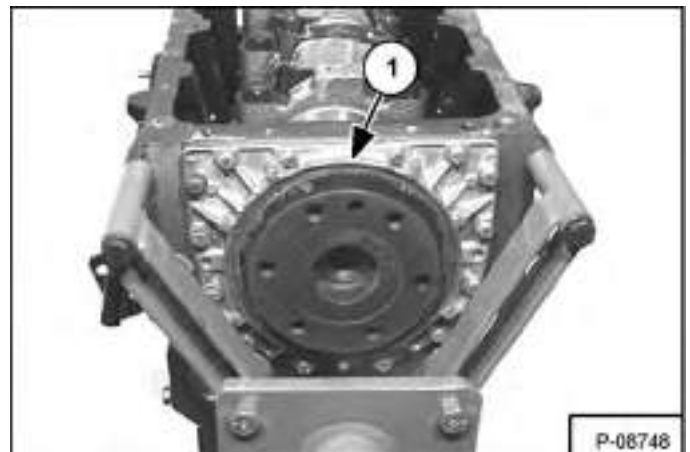

Remove the water pump. (See Page 70-100-39.)

Remove timing case cover. (See Page 70-100-19.)

Remove the fuel injection pump (See "Fuel Injection Pump Removal" on page 70-70-1.)

Remove the timing gears and timing case. (See "Timing Case And Gear Removal" on page 70-100-20.)

Remove the flywheel (See "Removal And Installation" on page 70-90-1.)

Remove the pistons and connecting rods (See "Pistons And Connecting Rods Removal" on page 70-100-25), keeping them in order.

Remove the rear oil seal housing (Item 1) [Figure 70-100-90].

## RECONDITIONING THE ENGINE (CONT'D)

### Crankshaft And Bearings Removal (Cont'd)

Figure 70-100-91

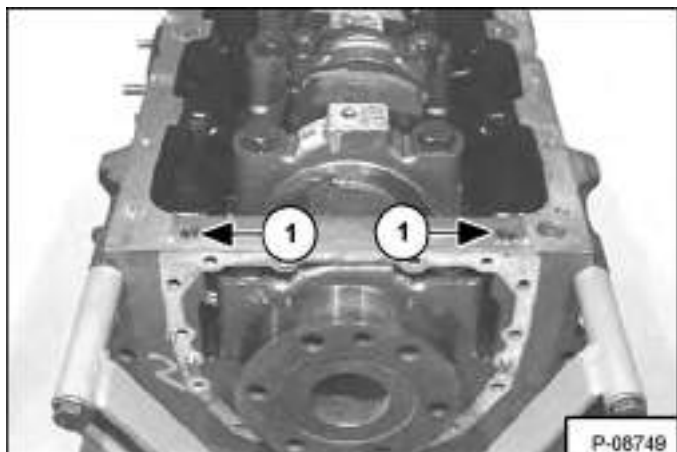

Remove the two bolts (Item 1) [Figure 70-100-91] retaining the bridge piece.

Remove the bridge piece.

Figure 70-100-92

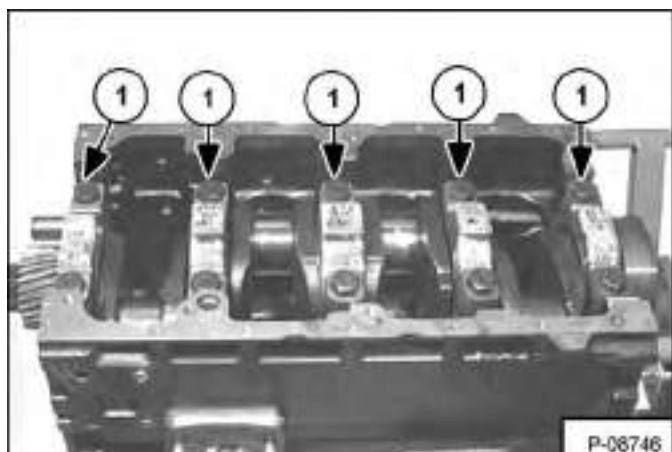

Mark the main bearing caps (Item 1) [Figure 70-100-92] for correct installation.

Remove the main bearing cap bolts.

Figure 70-100-93

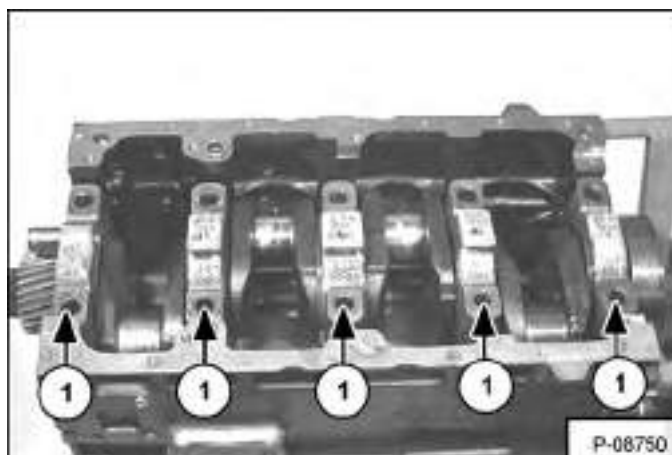

Remove the main bearing caps (Item 1) [Figure 70-100-93].

Figure 70-100-94



Remove the thrust washers from the sides of the center main bearing bore [Figure 70-100-94].

## RECONDITIONING THE ENGINE (CONT'D)

### Crankshaft And Bearings Removal (Cont'd)

Figure 70-100-95

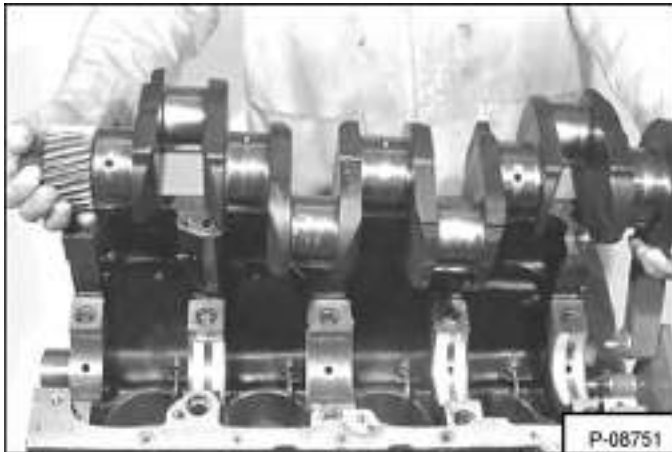

Remove the crankshaft [Figure 70-100-95].

Figure 70-100-96



Remove the crankshaft bearings from the engine block [Figure 70-100-96].

Keep the bearings with their respective caps for installation.

### Inspection Of Crankshaft And Bearings

Figure 70-100-97

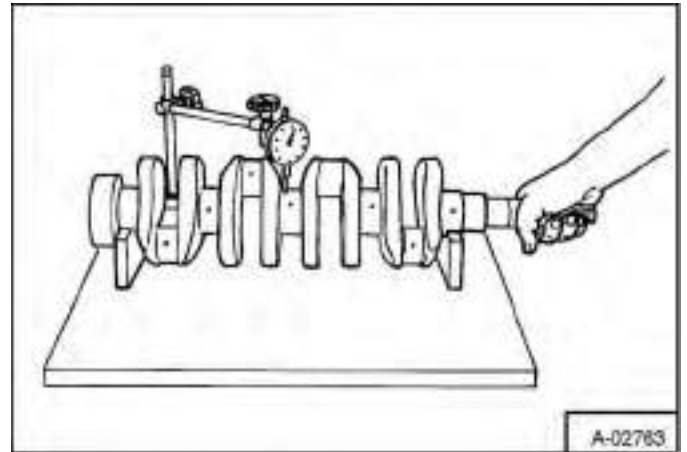

Check the crankshaft for wear [Figure 70-100-97]. The maximum wear and out of round of the crank journals is 0.0016 inch (0,04 mm).

The main journals and the crank pins of standard size can be machined 0.010 inch (0,25 mm) 0.020 inch (0,50 mm) or 0.030 inch (0,75 mm).

**NOTE:** See “ENGINE SPECIFICATIONS” on page SPEC-20-1 for more crankshaft specifications.

Check the oil clearance of the bearings.

All Main Bearings	0.0022 - 0.0046 inch (0,057 - 0,117 mm)
-------------------	---

Thrust Washer Thickness	
Standard	0.089 - 0.091 inch (2,26 - 2,31 mm)
Oversize	0.096 - 0.098 inch (2,45 - 2,50 mm)

## RECONDITIONING THE ENGINE (CONT'D)

### Crankshaft And Bearings Installation

Figure 70-100-98

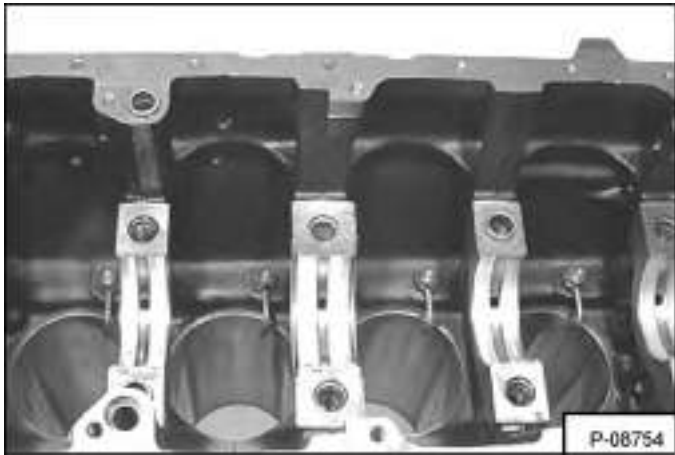

Clean the main bearing bores and install the upper bearing shells in position. Lubricate the bearings with clean engine oil [Figure 70-100-98].

**NOTE: Only the upper half of the bearings has oil lubrication holes and must be installed in the cylinder block.**

Figure 70-100-99

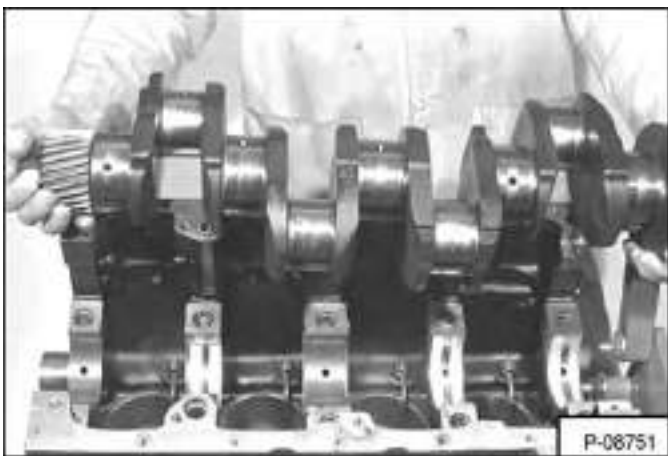

Make sure the main journals are clean and install the crankshaft in the block [Figure 70-100-99].

Make sure the locating pins for the main caps are in position.

Figure 70-100-100



Clean and install the upper and lower thrust bearings on each side of the center main bearing [Figure 70-100-100].

Clean the main caps and install the bearings.

Lubricate the bearings with clean engine oil.

Install the main cap bolts and torque in steps working from the center outward.

Step 1	65 ft.-lb. (88 N•m)
Step 2	125 ft.-lb. (170 N•m)
Step 3	185 ft.-lb. (250 N•m)

Clean the bridge piece and apply a bead of LOCTITE #518 in the corners and around the thread holes on the block.



## RECONDITIONING THE ENGINE (CONT'D)

### Crankshaft And Bearings Installation (Cont'd)

Figure 70-100-101



Install the bridge piece, and using a straight edge, align the bridge with the cylinder block **[Figure 70-100-101]**. Tighten the bridge retaining bolts to 12 ft.-lb. (16 N•m) torque.

Figure 70-100-102

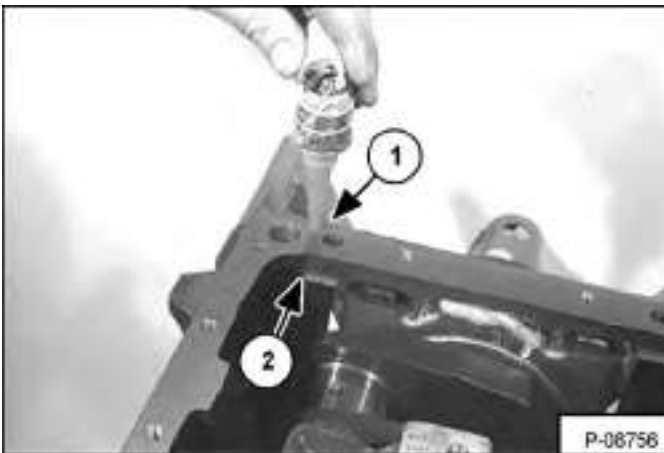

Inject LOCTITE #518 into the groove (Item 1) at each end of the bridge piece. Continue to inject sealant until it leaves the lower groove (Item 2) **[Figure 70-100-102]** at the front and rear of the piece.

### Rear Oil Seal Removal

Remove the bolts that retain the seal housing. Remove the housing.

Inspect the seal for wear or damage. Replace even if there is only a small nick or scratch.

Inspect the crankshaft flange for damage.

Clean the block, seal housing, and crankshaft.

### Rear Oil Seal Housing Positioning

The tool listed will be needed to do the following procedure;

MEL1532 - Rear Crankshaft Seal Installation Tool

Figure 70-100-103

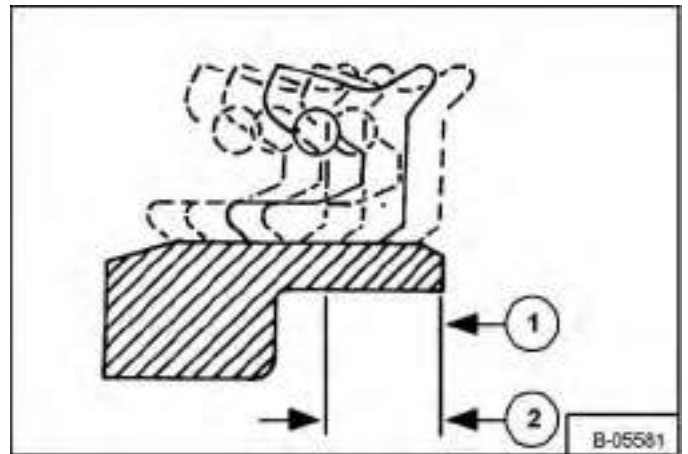

The seal can be installed from flush with the housing face (Item 1) to 0.27 inch (6,86 mm) (Item 2) **[Figure 70-100-103]** back from the housing face. Install seal so that the seal lip does not line up with any worn areas on the crankshaft.

## RECONDITIONING THE ENGINE (CONT'D)

### Rear Oil Seal Housing Positioning (Cont'd)

Figure 70-100-104



Install the seal in the seal housing using the seal installation tool. Seat the seal to the correct depth [Figure 70-100-104].

### Rear Oil Seal Installation

Install the new seal in the housing.

Figure 70-100-105

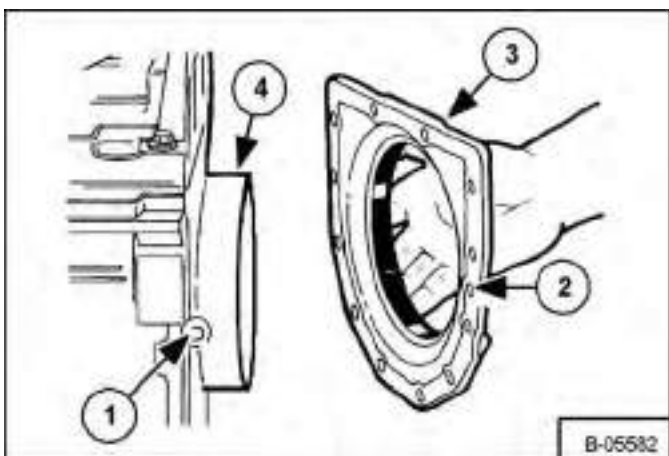

Make sure the dowels (Item 1) [Figure 70-100-105] are in the block correctly.

Install the new gasket (Item 2) on the housing (Item 3) [Figure 70-100-105].

Install the seal replacer tool (PD145-3) (Item 4) [Figure 70-100-105] on the crankshaft.

Lubricate the seal, tool, and crankshaft with clean engine oil.

Carefully push the seal and housing (Item 3) [Figure 70-100-105] over the tool and crankshaft and into position on the dowels. Remove the tool.

Figure 70-100-106

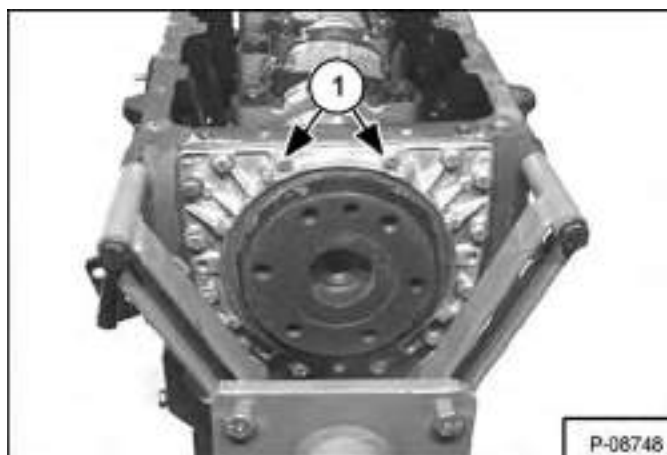

Tighten the bolts (Item 1) [Figure 70-100-106] to 16 ft.-lb. (22 N•m) torque.

### Checking Crankshaft End Play

The axial movement of the crankshaft is controlled by two half thrust washers placed on both sides of the center main bearing.

Figure 70-100-107



Install a dial indicator on the end of the crankshaft [Figure 70-100-107].

Pry the crankshaft to the rear of the cylinder block and set the dial indicator to zero.

## RECONDITIONING THE ENGINE (CONT'D)

### Checking Crankshaft End Play (Cont'd)

Figure 70-100-108

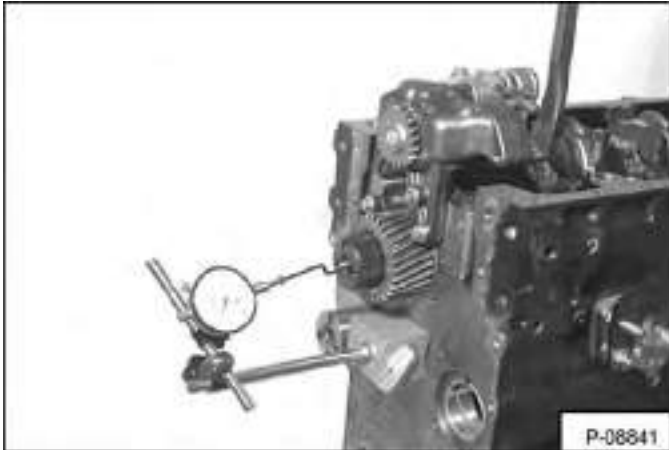

Remove the pry bar and record the dial indicator reading [Figure 70-100-108].

The end play specification is 0.002 - 0.015 inch (0,05 - 0,38 mm) maximum.

If end play is excessive there is over size thrust washers available to reduce movement.

Figure 70-100-109

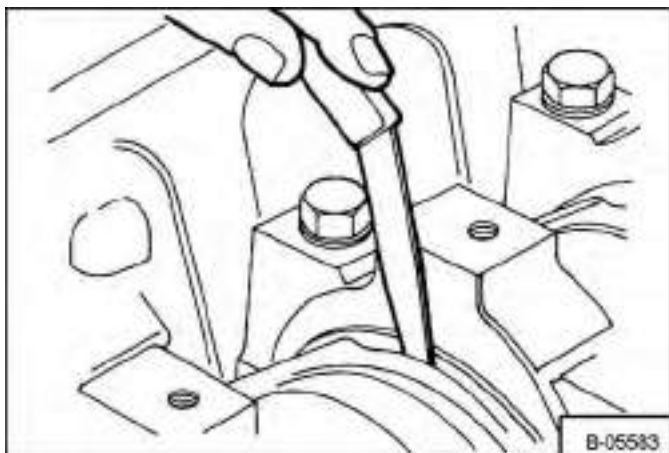

The end play can also be checked using a feeler gauge [Figure 70-100-109].

Pry the crankshaft to the rear of the cylinder block and measure the distance between the thrust washer and crankshaft.

## Cooling System Description

Figure 70-100-110

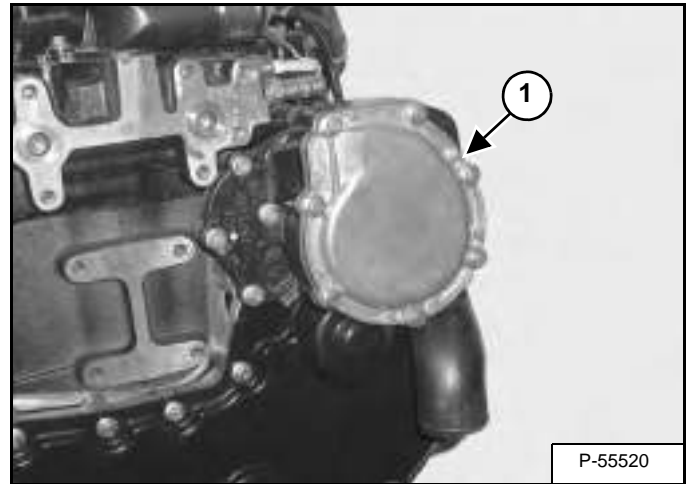

Coolant from the radiator passes through the centrifugal water pump (Item 1) [Figure 70-100-110], to assist the flow of the coolant through the system.

The water pump is gear driven from the gear off the fuel injection pump.

From the water pump, the coolant passes through a passage in the timing case.

The coolant passes through a passage in the left side of the cylinder block to the rear of the cylinder block.

Figure 70-100-111

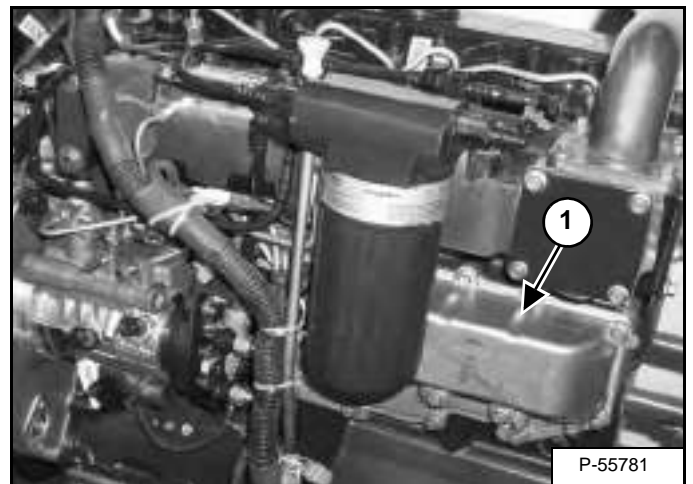

The oil cooler (Item 1) [Figure 70-100-111] is installed on the left side of the engine. Coolant from the by-pass connection at the rear of the coolant pump passes through a pipe to the oil cooler.

## RECONDITIONING THE ENGINE (CONT'D)

### Cooling System Description (Cont'd)

Figure 70-100-112

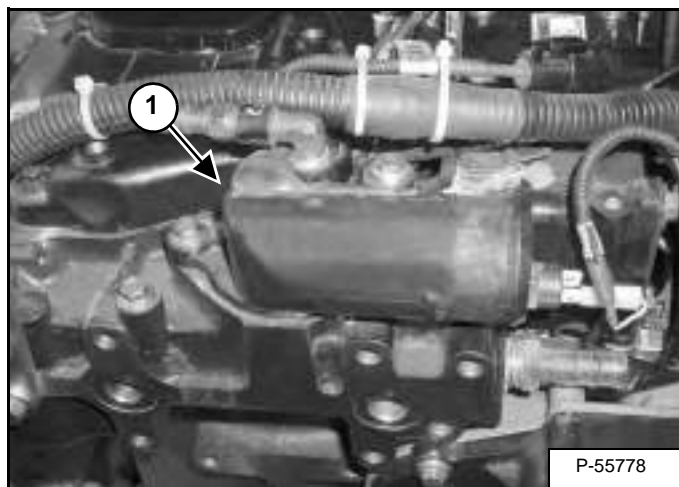

The coolant then passes around the cylinders and in the cylinder head. The coolant leaves the cylinder head at the front and passes into the thermostat housing (Item 1) [Figure 70-100-112].

If the thermostat is closed, the coolant goes directly through a by-pass to the inlet side of the water pump. If the thermostat is open, the thermostat closes the by-pass and the coolant passes to the radiator.

### Thermostat Removal and Installation

Drain the engine coolant until it is below the thermostat level.

Figure 70-100-113

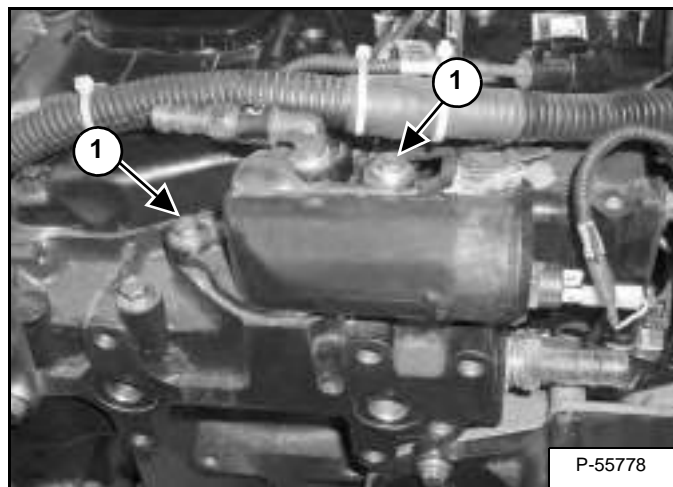

Remove the bolts (Item 1) [Figure 70-100-113] and thermostat housing.

**Installation:** Make sure all gasket surfaces are clean. Replace the gasket before installing the thermostat housing.

Figure 70-100-114



Remove the housing and thermostat [Figure 70-100-114].

## RECONDITIONING THE ENGINE (CONT'D)

### Thermostat Testing

Hang the thermostats in a suitable container filled with coolant.

Heat the coolant gradually. Use a thermometer to check the temperature when it starts to open and when it's fully open.

If the thermostats do not operate correctly they must be replaced.

**NOTE: Identify thermostat temperature by the stamping on the by-pass valve.**

### Lubricating Oil Cooler Removal And Installation

Figure 70-100-115

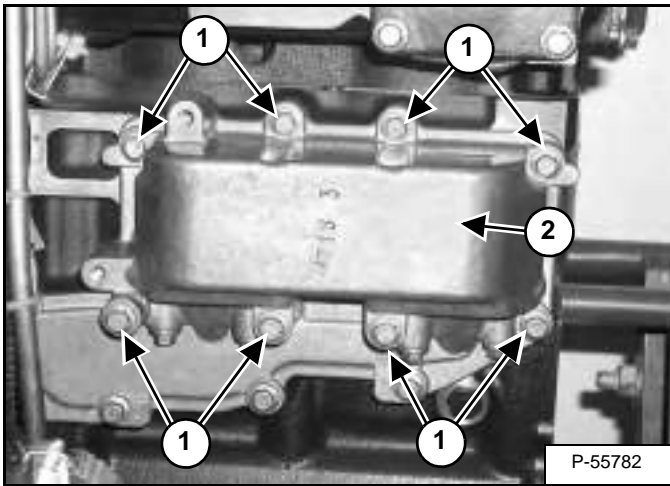

Remove the eight mounting bolts (Item 1) and remove the cooler (Item 2) [Figure 70-100-115].

**Installation:** Check oil level using the dipstick add oil as needed.

### Water Pump Removal

Remove the coolant from the cooling system.

Figure 70-100-116

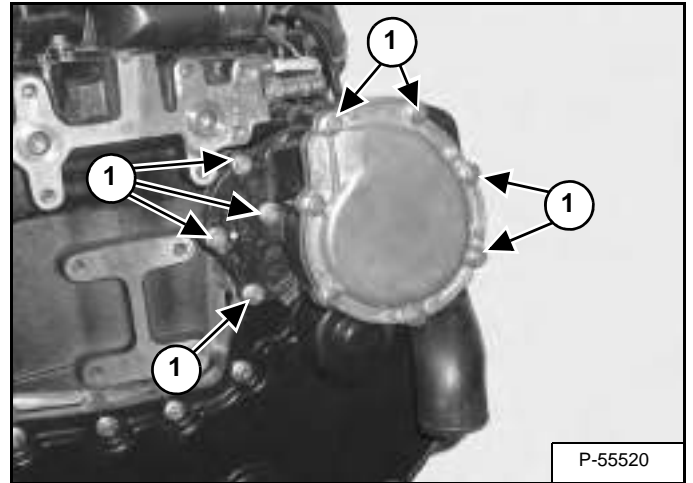

Remove the mounting bolts (Item 1) [Figure 70-100-116] from the water pump.

Remove the water pump.

### Water Pump Installation

Clean the gasket surfaces and replace the gasket.

Install the water pump in the timing cover. The pump is a tight fit in the cover and is pulled into position by tightening the bolts evenly.

Install the water pump bolts (Item 1) [Figure 70-100-116] and tighten to 16 ft.-lb. (72 N•m) torque.

## RECONDITIONING THE ENGINE (CONT'D)

### Engine Lubrication System Description

Figure 70-100-117

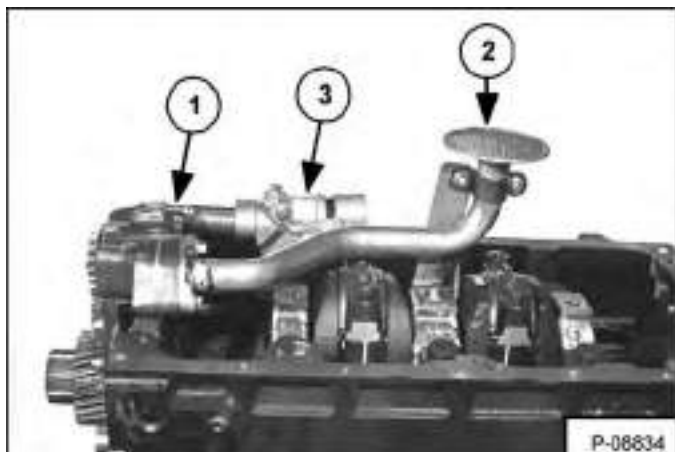

Pressure lubrication is supplied by a rotor type pump (Item 1) [Figure 70-100-117] which is driven through an idler gear from the crankshaft gear.

Engine oil from the oil pan sump passes through a strainer (Item 2) [Figure 70-100-117] and pipe to the suction side of the pump.

The engine oil passes from the outlet side of the pump through a pipe to a relief valve (Item 3) [Figure 70-100-117], which is installed in the bottom left side of the cylinder block. The relief valve opens if the oil pressure is too high; this allows some of the engine oil to return to the sump.

Figure 70-100-118

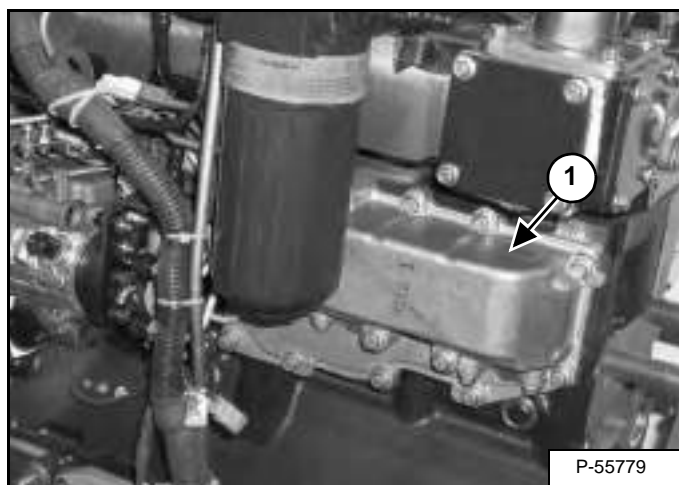

From the relief valve, engine oil passes to a plate type oil cooler (Item 1) [Figure 70-100-118].

Figure 70-100-119

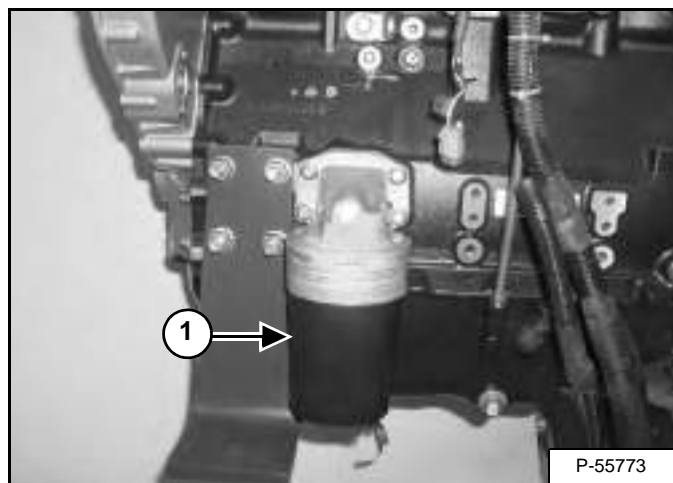

The engine oil passes from the filter (Item 1) [Figure 70-100-119] to the cylinder block.

The oil passes to the main bearings of the crankshaft and through passages in the crankshaft to the big end bearings. The pistons and the cylinder bores are lubricated by splash and oil mist.

Engine oil passes from the main bearings through passages in the cylinder block to the journals of the camshaft. Engine oil passes from the center journal of the camshaft through a passage in the cylinder block and cylinder head to a restriction in the pedestal of the rocker shaft, at a reduced pressure, to feed the rocker bushing. The oil passes through a passage in the rocker shaft to the bearings of the rocker levers. The valve stems, valve springs and the tappets are lubricated by splash and oil mist.

The hub of the idler gear is lubricated by oil from the cylinder block and the timing gears are splash lubricated.

The turbocharger is lubricated by oil after the filter. Oil is supplied from a connection on the right side of the cylinder block through an external pipe to the turbocharger. The oil passes through the turbocharger and returns through a pipe to the oil pan sump.

## RECONDITIONING THE ENGINE (CONT'D)

### Engine Lubrication System Description (Cont'd)

Figure 70-100-120

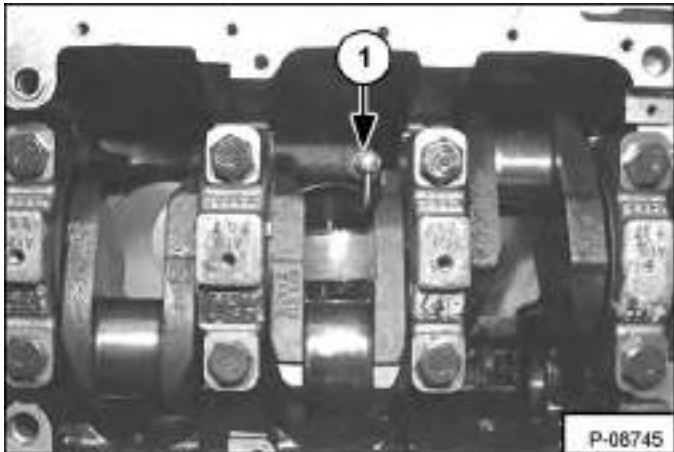

Turbocharged engines have piston cooling jets (Item 1) [Figure 70-100-120]. These jets are connected to the oil pressure rail and spray lubricating oil inside the pistons to keep them cool.

### Oil Filter Adapter Removal And Installation

Figure 70-100-121

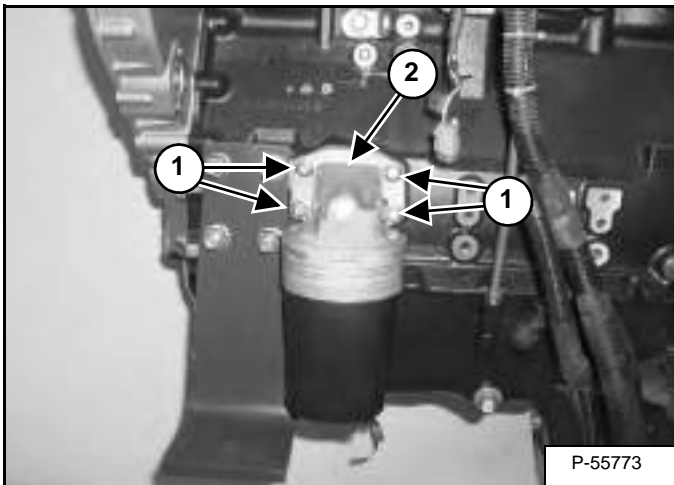

Remove the oil filter.

Remove the four bolts (Item 1) and the filter adapter (Item 2) [Figure 70-100-121].

Clean the filter adapter and the block mounting surfaces.

Using a new gasket, install the adapter (Item 2) [Figure 70-100-121] on the block.

Install the oil filter.

## Oil Pan Removal And Installation

Figure 70-100-122



Remove the oil pan retaining bolts [Figure 70-100-122].

Remove the pan and gasket.

Clean the pan in solvent and dry with compressed air.

Clean the block surface.

**Installation:** Place a new gasket on the oil pan. Place two bolts on each side to position the oil pan correctly. Install the remaining bolts. Tighten the bolts to 16 ft.-lb. (22 N•m) torque [Figure 70-100-122].

## RECONDITIONING THE ENGINE (CONT'D)

### Oil Screen And Pick-up Tube

Figure 70-100-123

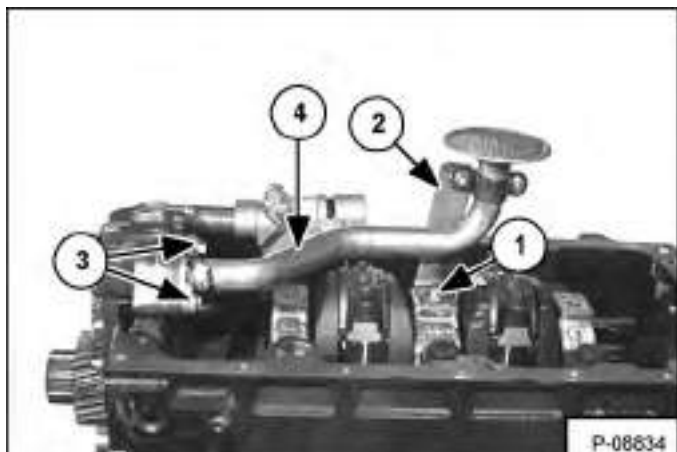

Remove the bolt (Item 1) that holds the bracket (Item 2) [Figure 70-100-123] to the main bearing cap.

Remove the bolts (Item 3) [Figure 70-100-123] from the pick-up tube flange.

Remove the pick-up tube (Item 4) [Figure 70-100-123] and gasket.

Wash the assembly in solvent and dry with compressed air.

Check the tube and strainer for cracks or other damage. Replace as necessary.

Loosely assemble the bracket (Item 2) [Figure 70-100-123] with the pick-up tube to the main bearing cap.

Install the pick up tube gasket and mounting bolts (Item 3) [Figure 70-100-123].

Tighten the mounting bolts to 16 ft.-lb. (22 N•m) torque.

Tighten the bolt (Item 1) [Figure 70-100-123] for the pick-up tube bracket.

Tighten the bolt to 16 ft.-lb. (22 N•m) torque.

### Oil Pump Removal

**NOTE:** The oil pump has a channel in the body of the pump. Oil from the front main bearing passes down the channel of the pump to an oil hole in the idler shaft for lubrication of the idler shaft bushing.

Remove the oil pan (See "Oil Pan Removal And Installation" on page 70-100-41.)

Figure 70-100-124

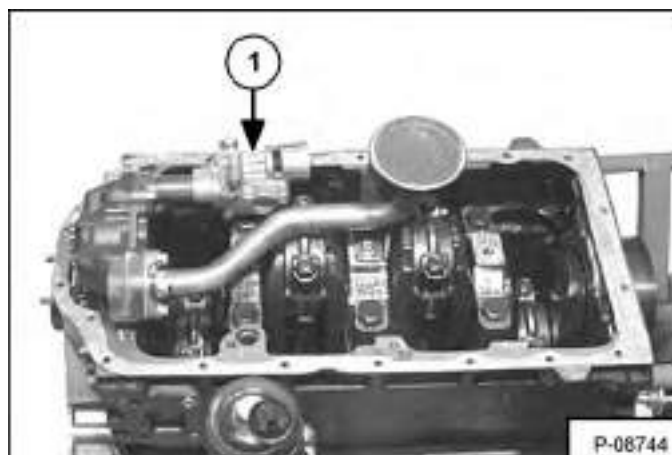

Remove the oil pressure relief valve (Item 1) [Figure 70-100-124].

Remove the oil screen and pick-up tube.

The oil pump is installed on the number 1 main bearing cap.

**NOTE:** The pump can be removed with the main bearing cap if a spanner wrench is available that will allow the torque to be applied directly to the main cap bolts.

If there is no spanner wrench, the front timing case cover must be removed (See "Timing Cover Removal" on page 70-100-19.).

Figure 70-100-125

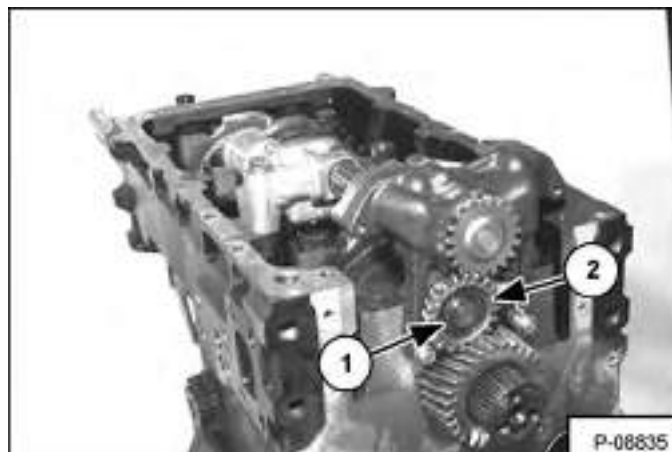

Remove the snap ring (Item 1), idler gear (Item 2) [Figure 70-100-125], and washer.

Remove the bolts and oil pump.



## RECONDITIONING THE ENGINE (CONT'D)

### Oil Pump Installation

Figure 70-100-126

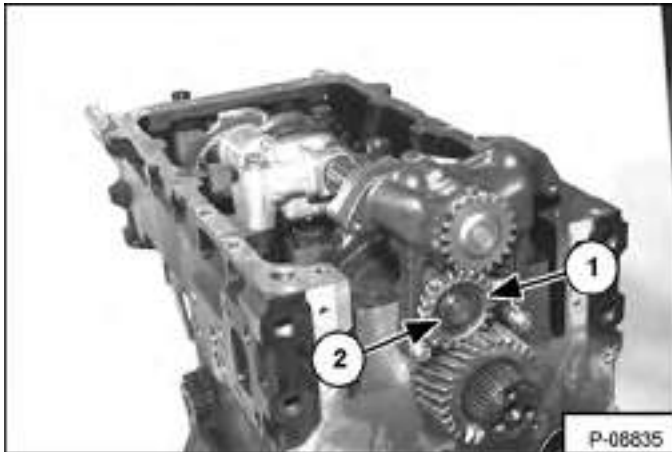

Fill the pump with engine oil.

If the number one main cap was removed, reinstall and tighten to 185 ft.-lb. (250 N•m) torque.

Install the pump on the main cap and tighten to 16 ft.-lb. (22 N•m) torque.

Check the idler gear and bushing for wear.

Lubricate with clean engine oil and install the washer, idler gear (Item 1) and snap ring (Item 2) [Figure 70-100-126].

Check the backlash between oil pump and idler gears.

There must be a minimum of 0.003 inch (0,076 mm).

Figure 70-100-127

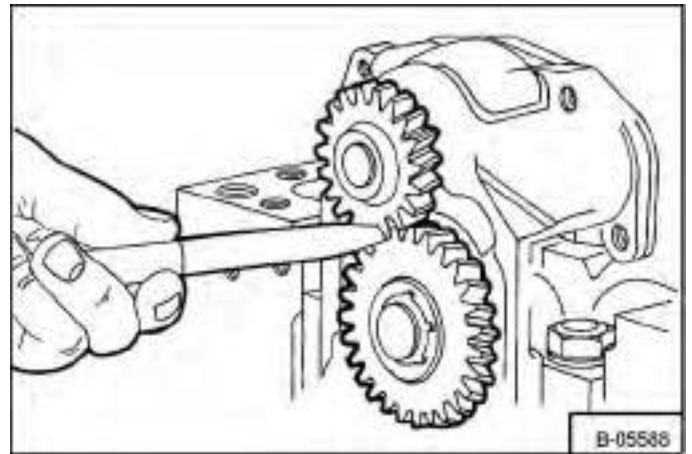

Check that there is a minimum of 0.003 inch (0,076 mm) backlash between the idler gear and oil pump gear [Figure 70-100-127].

End play for the idler gear should be 0.0019/0.0108 inch (0,050/0,275 mm).

Install the oil screen and pick-up tube (See "Oil Screen And Pick-up Tube" on page 70-100-42.)

Install the pressure relief valve.

Install the oil pan (See "Oil Pan Removal And Installation" on page 70-100-41.)

## RECONDITIONING THE ENGINE (CONT'D)

### Oil Pump Disassembly And Assembly

Figure 70-100-128

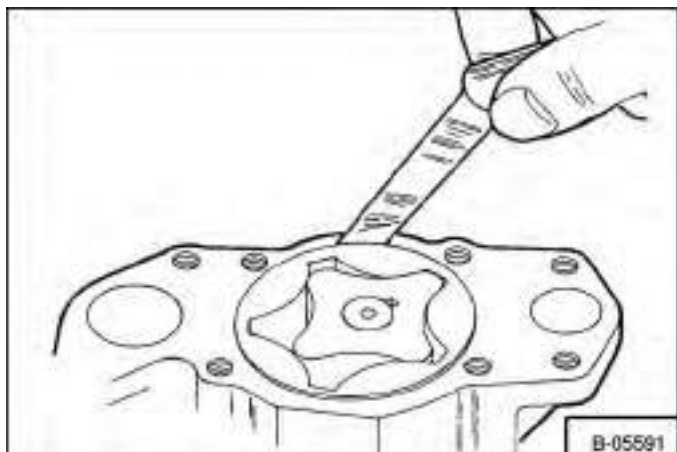

**NOTE: If any part is worn enough to effect performance replace the complete oil pump.**

Remove the cover of the oil pump.

Remove the outer rotor and thoroughly clean. Check for cracks or other damage.

Install the outer rotor and check the outer rotor to body clearance [Figure 70-100-128].

Clearance between the outer rotor and body must be 0.006-0.013 inch (0,15-0,34 mm).

Figure 70-100-129

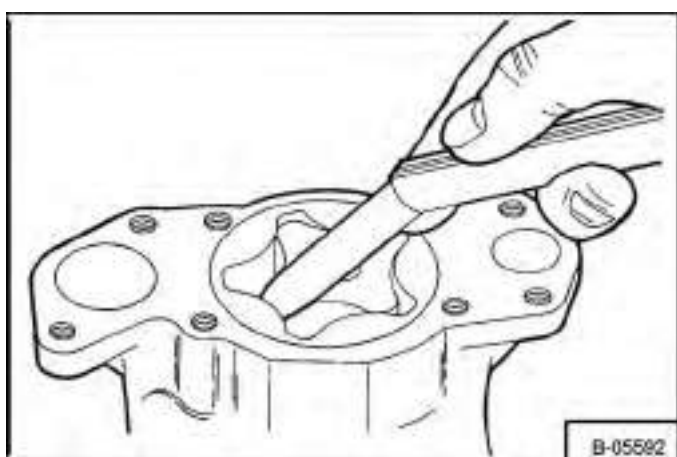

Check the inner rotor to outer rotor clearance [Figure 70-100-129].

Clearance between the inner rotor and outer rotor must be 0.0015 - 0.005 inch (0,04-0,13 mm).

Figure 70-100-130

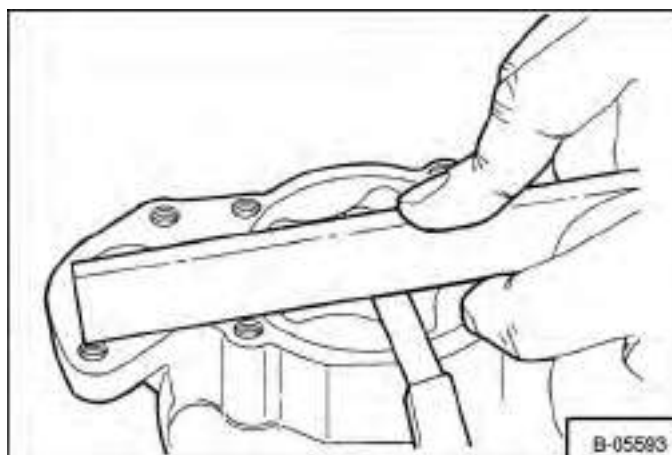

Check the rotor end play [Figure 70-100-130].

Rotor end play must be 0.001-0.004 inch (0,03-0,10 mm).

Install the cover and tighten the bolts to 16 ft.-lb. (22 N•m) torque.

### Oil Pressure Relief Valve Disassembly And Assembly

Figure 70-100-131

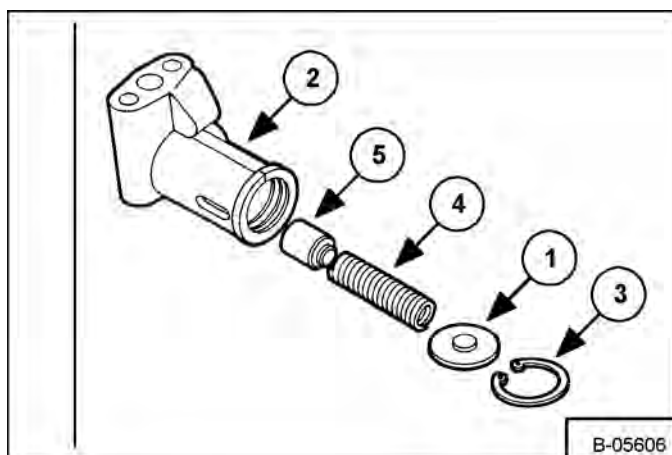

Press the end plate (Item 1) in the valve body (Item 2) and remove the snap ring (Item 3) [Figure 70-100-131].

Remove the end plate (Item 1), spring (Item 4), and plunger (Item 5) from the body (Item 2) [Figure 70-100-131].

Clean the parts in solvent and dry with compressed air.

Lubricate the bore of the valve body (Item 2), plunger (Item 5) and the end plate (Item 1) [Figure 70-100-131] with clean engine oil before assembly.

## RECONDITIONING THE ENGINE (CONT'D)

### Engine Block Description

Figure 70-100-132

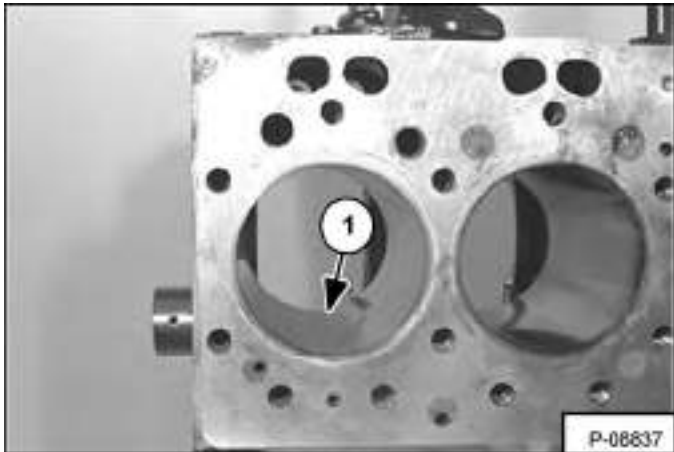

The cylinder block is made of cast iron and provides full length support for the dry liners.

The liners (Item 1) [Figure 70-100-132] are made of cast iron. Production liners are a press fit and service liners are a transition fit. Both types of liners are honed with silicon carbide tools to a specially controlled finish to ensure long engine life and low oil consumption.

Figure 70-100-133

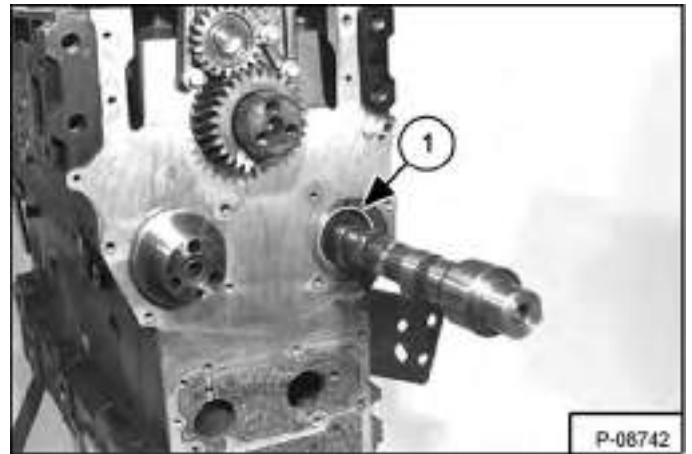

A bushing (Item 1) [Figure 70-100-133] is installed in the cylinder block for the front camshaft journal while the other camshaft journals run directly in the block.

### Engine Block Disassembly And Assembly

Remove the water pump (See "Water Pump Removal" on page 70-100-39.)

Remove the fuel injection pump (See "Fuel Injection Pump Removal" on page 70-70-1).

Remove the oil cooler (See "Removal And Installation" on page 70-50-1).

Remove the oil filter and oil pan (See "Oil Pan Removal And Installation" on page 70-100-41)

Remove the turbocharger (See "Turbo Charger Removal And Installation" on page 70-100-2)

Remove the lift fuel pump (See "Fuel Lift Pump Removal And Installation" on page 70-70-10).

Remove the starter (See "Removal And Installation" on page 60-40-1).

Remove the cylinder head (See "Cylinder Head Removal" on page 70-100-6)

Remove the timing case and gears (See "Timing Case And Gear Removal" on page 70-100-20)

Remove the piston and connecting rod assemblies (See "Pistons And Connecting Rods Removal" on page 70-100-25)

Remove the camshaft and tappets (See "Camshaft And Tappets Removal" on page 70-100-23)

Remove the engine mounting bracket and flywheel (See "Removal And Installation" on page 60-40-1).

Remove the rear oil seal and the crankshaft (See "Rear Oil Seal Removal" on page 70-100-35)

## RECONDITIONING THE ENGINE (CONT'D)

### Piston Cooling Jet Removal

Figure 70-100-134

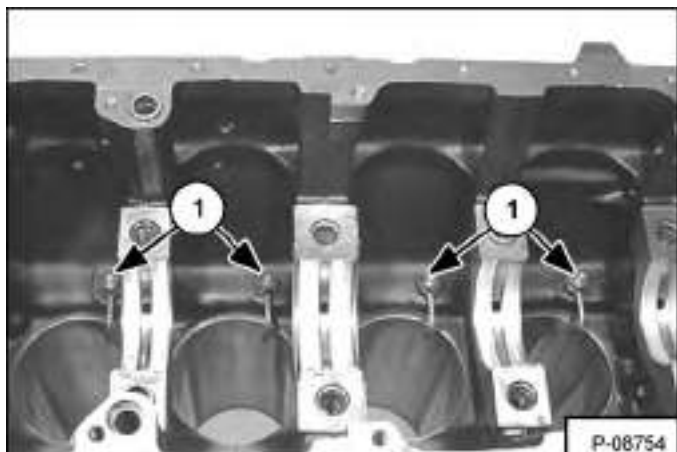

Remove the piston cooling jet assembly (Item 1) [Figure 70-100-134] from the engine block.

Figure 70-100-135

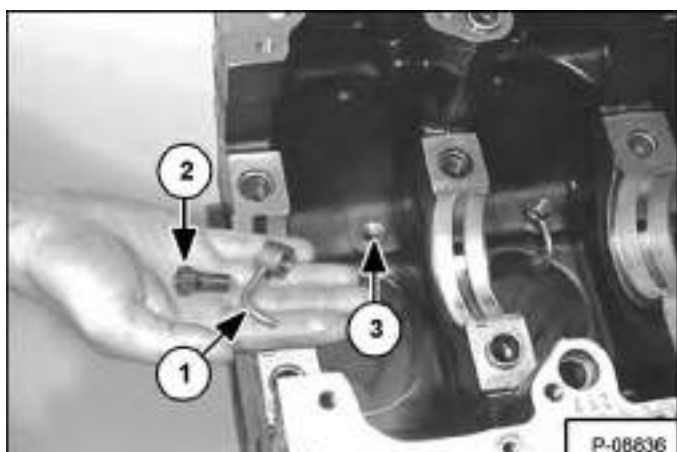

Inspect the jet tube (Item 1), mount bolt (Item 2) and alignment pin (Item 3) [Figure 70-100-135] for damage. Replace as needed.

### Piston Cooling Jet Installation

Clean all parts in solvent and dry with compressed air.

Install the cooling jet (Item 1) being sure it is seated correctly on the dowel (Item 3) [Figure 70-100-135] in the block.

Install the mounting bolt (Item 2) [Figure 70-100-135] and tighten to 7 ft.-lb. 9 N•m torque.

### Piston Cooling Jet Alignment

Figure 70-100-136

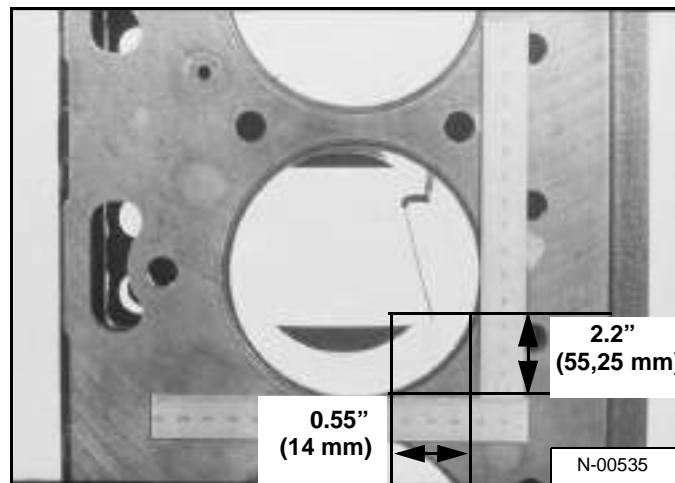

Insert a 0.067 inch (1,70 mm) diameter rod of suitable length, in the jet.

The tip of the rod must extend out the top of the cylinder in an area 2.2 inch (55,25 mm) in height and 0.55 inch (14 mm) of width to provide proper cooling jet alignment to cool the pistons [Figure 70-100-136].

### Inspection

Clean all passages of coolant and oil.

Check the block for cracks or other damage.

**NOTE:** The top face of the block must not be machined. This will affect liner flange depth and piston height above the top face of the cylinder block.

Check the camshaft bushing for wear. If the bushing needs to be replaced, press out old one. Press a new one in, insuring that the oil holes line up.

## RECONDITIONING THE ENGINE (CONT'D)

### Cylinder Liner Inspection

Figure 70-100-137

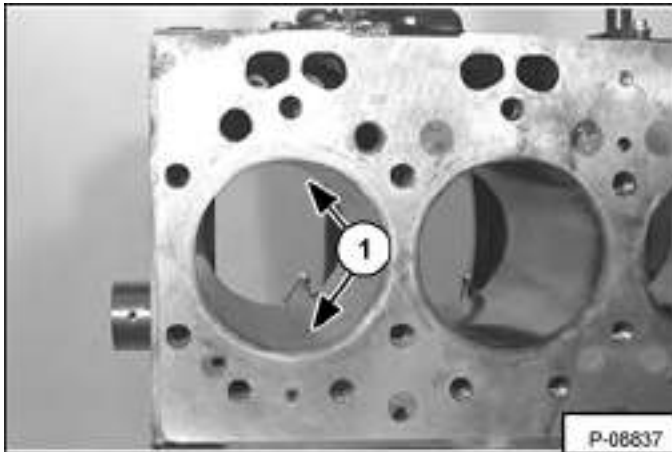

The condition of a cylinder liner is decided by:

- The amount and location of polished areas.
- Wear.
- Damage to the liner wall.

**NOTE: It is not necessary to replace the liners if: The honed finish can be clearly seen. Engine performance and oil consumption is acceptable.**

Examine the liner surface (Item 1) [Figure 70-100-137] for cracks, deep scratches and polished areas where the honed finish is worn away.

Figure 70-100-138

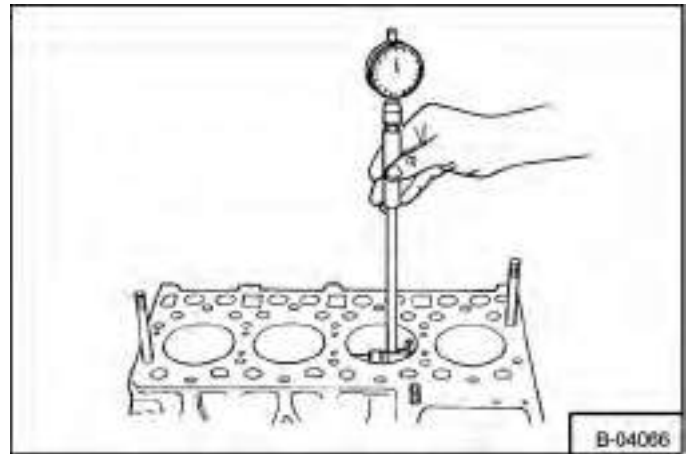

Check the cylinder liner bore for out of round or wear beyond service limits [Figure 70-100-138]. The inside diameter of the service liner should be 3.937-3.939 inch (100,00-100,06 mm).

A flex type hone may be used to clean up small scoring or pitting.

Damaged or worn liners must be replaced.

## RECONDITIONING THE ENGINE (CONT'D)

### Cylinder Liner Removal

Figure 70-100-139

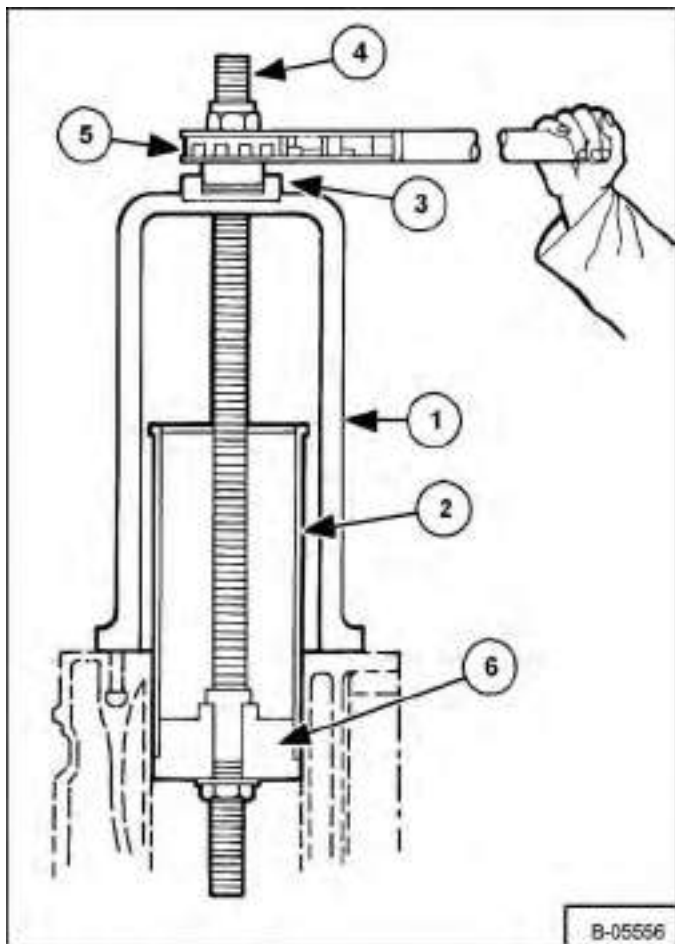

**NOTE:** Where several liners are to be removed or a very tight production liner is found, a press should be used.

When one liner is replaced, a hand tool is available and the following procedure can be done with the crank shaft installed.

Rotate the crankshaft (if installed) to provide access to the liner and protect the crank pin from damage.

Place the tool (Item 1) over the center of the liner (Item 2). Make sure the flat thrust block (Item 3) [Figure 70-100-139] is against the bottom of the recess.

Install the rod (Item 4) through the handle (Item 5) [Figure 70-100-139].

Place the adapter (Item 6) [Figure 70-100-139] under the cylinder liner. Tighten the nut and washer. Turn the handle and pull out the old liner.

## RECONDITIONING THE ENGINE (CONT'D)

### Cylinder Liner Installation

# IMPORTANT

For the first five hours after the new liners have been installed:

- Do not operate at full load.
- Do not operate at high speed.
- Do not allow engine to idle for extended periods.

I-2117-1196

Figure 70-100-140

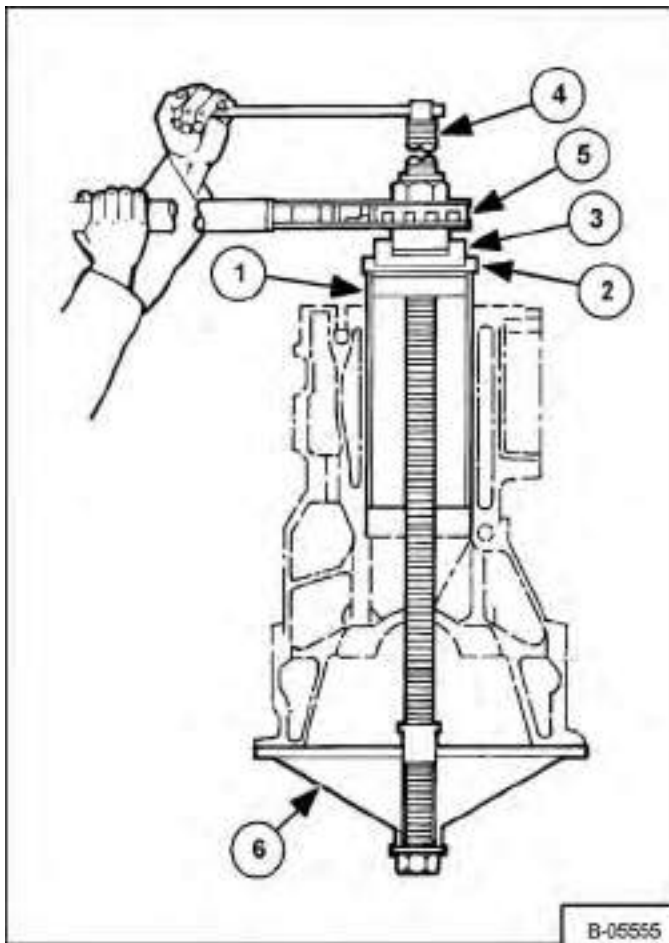

Clean the cylinder bore and the outside of the liner.

Lubricate the cylinder bore with engine oil.

Start the liner (Item 1) [Figure 70-100-140] in the bore. Make sure it is started straight.

With the adapter (Item 2) on the top of the liner, place the bearing (Item 3) [Figure 70-100-140] in the recess at the top.

Place the threaded rod (Item 4) through the handle (Item 5) and liner (Item 1) [Figure 70-100-140].

Adjust the rod until it is below the bottom of the block surface.

Install the adapter (Item 6) [Figure 70-100-140] on the rod. Center the adapter against the bottom of the block.

Tighten the nut and washer.

Turn the handle and press the liner in the bore, stopping when approximately 2 inch (50 mm) remain. Apply LOCTITE #603 to the outer surface below the flange and to the flange recess.

Continue to press the liner into position. Remove the tool.

**NOTE: Do Not hit the cylinder liners with a hammer. They will be damaged.**

Figure 70-100-141

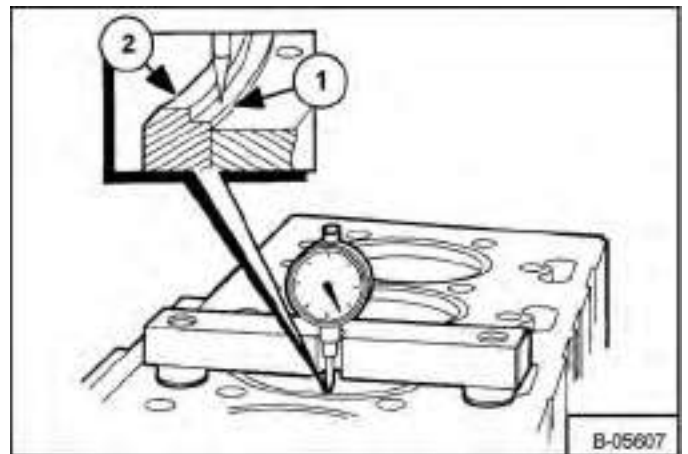

Check liner protrusion with a dial gauge [Figure 70-100-141].

The liner may have 0.004 inch (0,10 mm) protrusion or recession from the block face.

Allow 15 minutes before measuring the bore. The liner will take six hours to reach full strength.

The inside diameter of the service liner should be 3.937-3.939 in. (100,00- 100,06 mm).

New piston rings must be used when the cylinder liners have been replaced.

The measurement must be from the flange (Item 1) of the cylinder liner, not the top of the flame ring (Item 2) [Figure 70-100-141].



**Bobcat®**



---

## HEATING, VENTILATION, AIR CONDITIONING

AIR CONDITIONING SERVICE .....	80-90-1
Chart .....	80-90-1
AIR CONDITIONING SYSTEM FLOW .....	80-10-1
Chart .....	80-10-2
Principals .....	80-10-1
BASIC TROUBLESHOOTING .....	80-50-1
Checking The Electrical System .....	80-50-2
Compressor Drive Belt Inspection .....	80-50-1
Poor A/C Performance .....	80-50-1
COMPONENTS .....	80-20-1
Identification .....	80-20-1
COMPRESSOR .....	80-110-1
Compressor Clutch Disassembly And Assembly .....	80-110-2
Removal And Installation .....	80-110-1
CONDENSER .....	80-120-1
Removal And Installation .....	80-120-1
EVAPORATOR / BLOWER UNIT .....	80-150-1
Removal And Installation .....	80-150-1
EXPANSION VALVE .....	80-160-1
Removal And Installation .....	80-160-1
GENERAL AIR CONDITIONING SERVICE GUIDELINES .....	80-60-1
Component Replacement And Refrigeration Leaks .....	80-60-2
Compressor Oil .....	80-60-1
Compressor Oil Check .....	80-60-1
HEATER ASSEMBLY .....	80-170-1
Core Removal And Installation .....	80-170-2
Fan Removal And Installation .....	80-170-2
Removal And Installation .....	80-170-1
PRESSURE SWITCH .....	80-140-1
Removal And Installation .....	80-140-1
RECEIVER / DRIER .....	80-130-1
Removal And Installation .....	80-130-1

HVAC

Continued On Next Page

---

## HEATING, VENTILATION, AIR CONDITIONING (CONT'D)

REGULAR MAINTENANCE .....	80-40-1
Cleaning The Condenser .....	80-40-2
Compressor Drive Belt Inspection .....	80-40-2
Filter Element Removal And Installation .....	80-40-1
SAFETY .....	80-30-1
Safety Equipment .....	80-30-1
SYSTEM CHARGING AND RECLAMATION .....	80-100-1
Charging Procedure .....	80-100-5
Charging Procedure With A Manifold Gauge Set .....	80-100-4
Reclamation Procedure .....	80-100-1
SYSTEM TROUBLESHOOTING CHART .....	80-70-1
TEMPERATURE / PRESSURE .....	80-80-1
Chart .....	80-80-1

---

## AIR CONDITIONING SYSTEM FLOW

### Principals

In an air conditioning system the refrigerant is circulated under pressure through five major components in a closed circuit. At these five points in the system the refrigerant goes through pressure and temperature changes.

The compressor (Item 1) takes in heated, low pressure refrigerant gas through the suction valve (low pressure side) and as the name indicates, pressurizes the heated refrigerant and forces it through the discharge valve (high pressure side) on the condenser (Item 2) (See "Chart" on page 80-10-2).

Ambient air passing through the condenser removes the heat from refrigerant resulting in physical state change in the refrigerant from a gas to a liquid.

The liquid refrigerant moves on to the receiver / drier (Item 3) where impurities such as moisture and dirt are filtered out. The receiver/drier also serves as the storage tank for the liquid refrigerant. The liquid refrigerant (still under high pressure) flows to the expansion valve (Item 4) (See "Chart" on page 80-10-2).

The expansion valve meters the amount of refrigerant into the evaporator coil (Item 5). As the refrigerant passes through the expansion valve, it again changes its physical state. It becomes a low temperature, low-pressure liquid and saturated vapor. The low pressure liquid immediately starts to boil and vaporize as it enters the evaporator. The hot humid air of the machine's cab is drawn through or blown into the evaporator by the blower fan (Item 6) (See "Chart" on page 80-10-2). Since the refrigerant is colder than the air, it absorbs the heat from the air and produces cooled air, which is pushed into the cab by the blower fan. The moisture in the air condenses on the evaporator coil and drips into the drain pan, which directs the water out of the cab.

The refrigerant cycle is completed when the heated low pressure gas is again drawn into the compressor.

# AIR CONDITIONING SYSTEM FLOW (CONT'D)

Chart

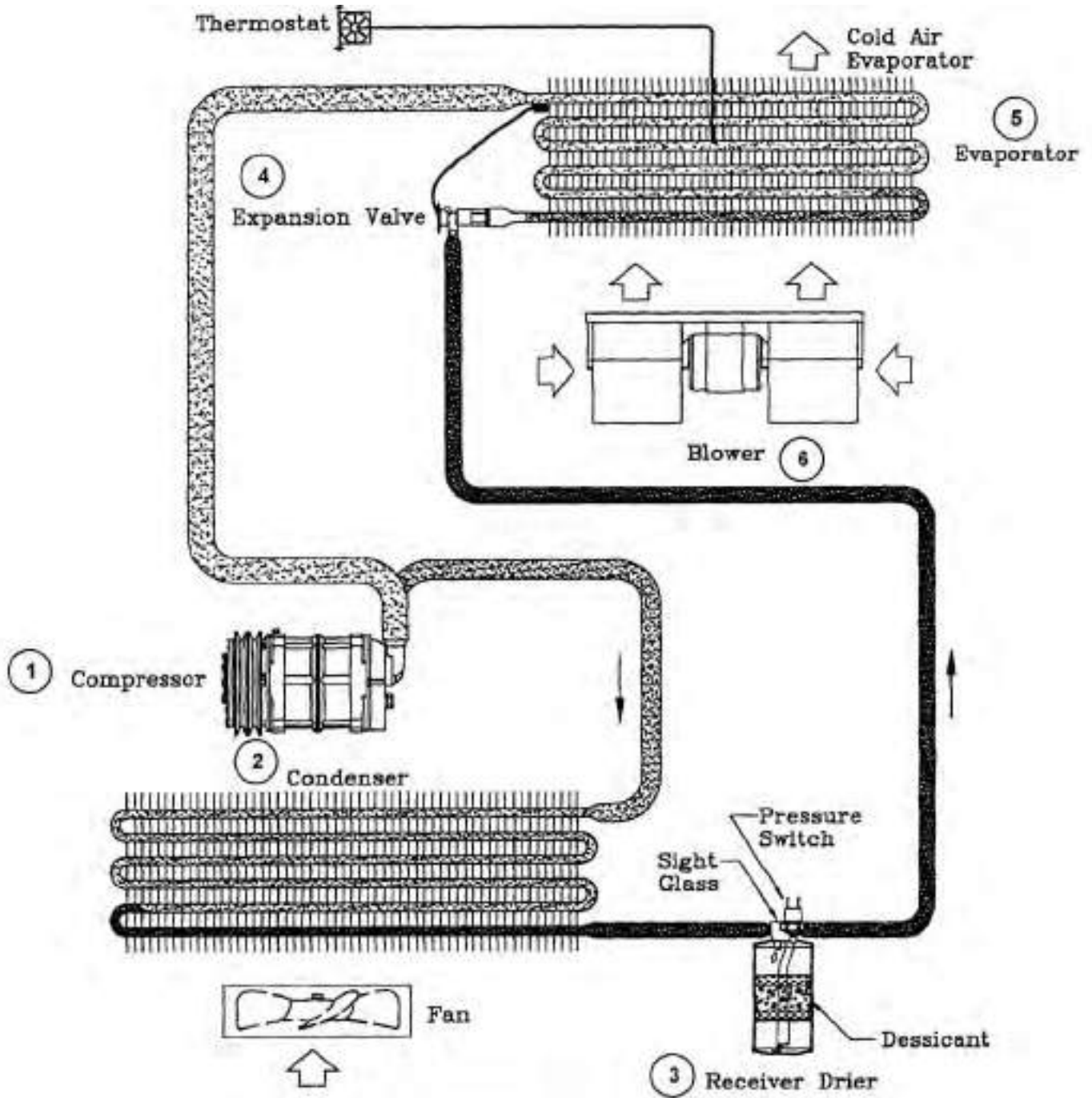

## Status Of R134a

 High Pressure Gas	 Low Pressure Liquid
 High Pressure Liquid	 Low Pressure Gas

## COMPONENTS

### Identification

Figure 80-20-1

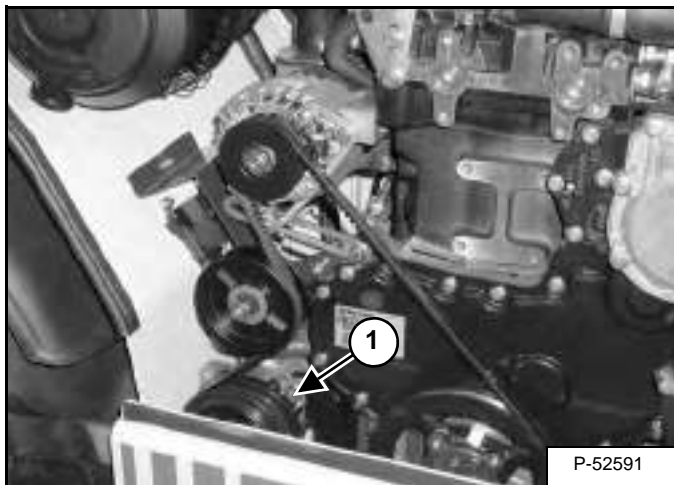

*Compressor:* The compressor (Item 1) [Figure 80-20-1] is the pump that circulates the refrigerant throughout the system. It raises the pressure of the refrigerant for heat transfer through the condenser and evaporator.

**NOTE:** The A/C System (compressor) is recommended to be turned on for at least 5 minutes weekly throughout the year to lubricate the internal components.

Figure 80-20-2

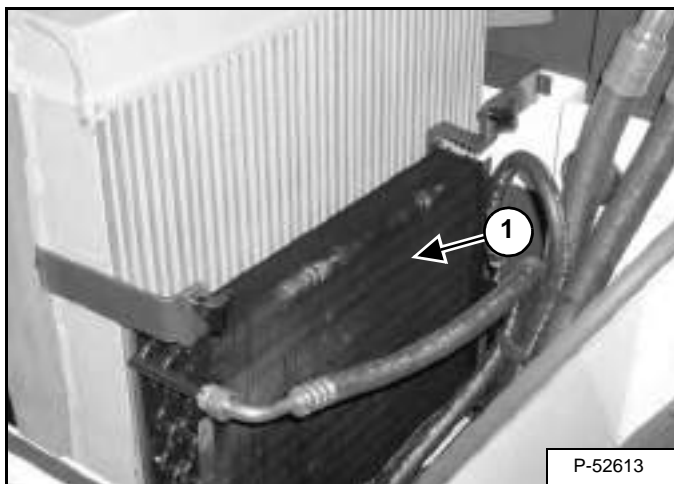

*Condenser:* The condenser (Item 1) [Figure 80-20-2] is the unit that receives the high pressure, high temperature refrigerant vapor from the compressor and condenses it into a high temperature liquid.

Figure 80-20-3

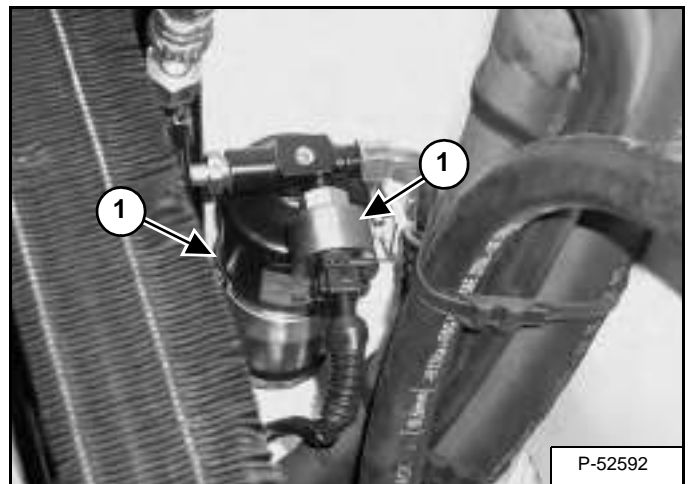

*Receiver / Drier:* The receiver / drier (Item 1) [Figure 80-20-3] is the unit that receives the liquid refrigerant from the condenser and removes moisture and foreign matter from the system. It also serves as a storage tank for the extra liquid refrigerant until it is needed by the evaporator.

Figure 80-20-4

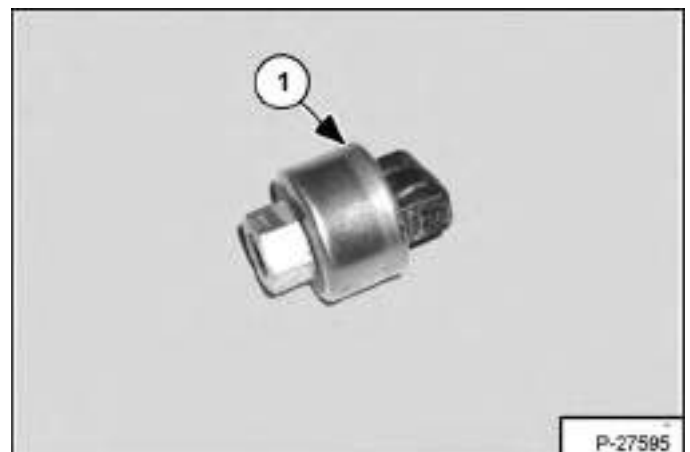

*Pressure Switch:* The pressure switch (Item 1) [Figure 80-20-4] is located on the receiver / drier assembly (Item 2) [Figure 80-20-3]. It will disengage the compressor clutch if the pressure readings are too low or too high, which indicates loss of refrigerant.

## COMPONENTS (CONT'D)

### Identification (Cont'd)

Figure 80-20-5



*Evaporator Unit:* The evaporator unit (Item 1) [Figure 80-20-5] is located behind the operator seat inside the cab. The unit delivers the cold air for the A/C into the cab. The unit also contains the blower fan, evaporator coil and thermostat which are not serviceable.

Figure 80-20-6



*Expansion Valve:* The expansion valve (Item 1) [Figure 80-20-6] controls the amount of refrigerant entering the evaporator coil.

Figure 80-20-7



*Blower Fan Switch:* This is a three position switch (Item 1) [Figure 80-20-7]. When the blower fan switch is in the OFF position the A/C will not engage.

## SAFETY

### Safety Equipment

In servicing A/C and heater systems you will be exposed to high pressures, temperatures and several chemical hazards. Moving belts and pulleys are normal shop hazards.

Figure 80-30-1



In addition to exercising caution in your work, **DO WEAR SAFETY GLASSES OR A FACE SHIELD [Figure 80-30-1]** when you are using R-134a or a leak detector, adjusting service valves or the manifold gage set connectors. Safety glasses or a transparent face shield are practical safety items and one or the other is absolutely required.

## WARNING

In the event of a leak, wear safety goggles. Escaping refrigerant can cause severe injuries to eyes. In contact with a flame, R134a refrigerant gives a toxic gas.

W-2371-0500

Figure 80-30-2



R-134a inside a canister or in an A/C system is a liquid under pressure. When it escapes or releases into the air, **ITS TEMPERATURE DROPS TO 21.6 F DEGREES "INSTANTLY"**. If it spills on your skin or in your eyes you should flood the area with cool water and **SEEK MEDICAL ATTENTION FAST!** It is a good idea to wear gloves [Figure 80-30-2] to prevent frost bite if you should get refrigerant on your hands.

## WARNING

HFC 134A refrigerant can be dangerous if not properly handled. Liquid 134A may cause blindness if it contacts the eyes and may cause serious frostbite if it contacts the skin.

- Gaseous 134A becomes lethal (phosgene) gas when it contacts open flame or very hot substances.
- **NEVER SMOKE** when there is the possibility of even small amounts of 134A in the air.

Any servicing work that involves release or addition of 134A to the system must be done by a competent refrigeration dealer who has the proper equipment, knowledge, and experience to service refrigeration equipment.

W-2373-0500



**Bobcat®**



## REGULAR MAINTENANCE

### Filter Element Removal And Installation

Figure 80-40-1

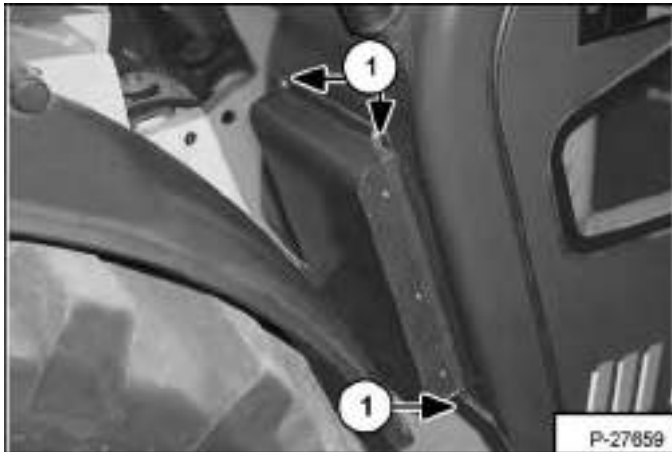

Remove the four mount bolts (Item 1) [Figure 80-40-1] from the fresh air filter cover at the front of the cab.

Figure 80-40-2

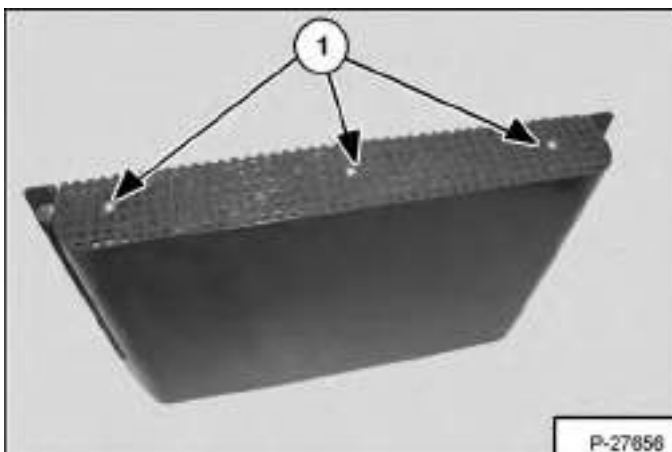

Remove the three filter mount bolts (Item 1) [Figure 80-40-2].

Figure 80-40-3

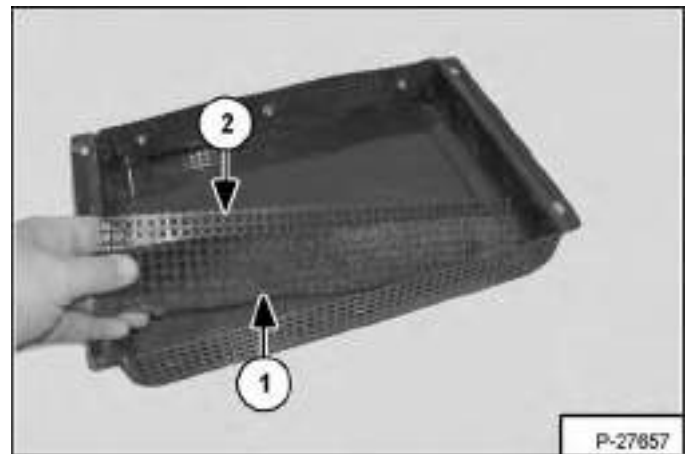

Remove the filter (Item 1) and backup screen (Item 2) [Figure 80-40-3].

Figure 80-40-4



The fresh air filter [Figure 80-40-4] is made of open cell foam and should be cleaned with water. A mild detergent may also be used.

## REGULAR MAINTENANCE (CONT'D)

### Compressor Drive Belt Inspection

It is a good rule to regularly inspect (weekly) the compressor drive belt for tension and wear.

Open the engine cover.

Remove the drive belt cover.

**Figure 80-40-5**

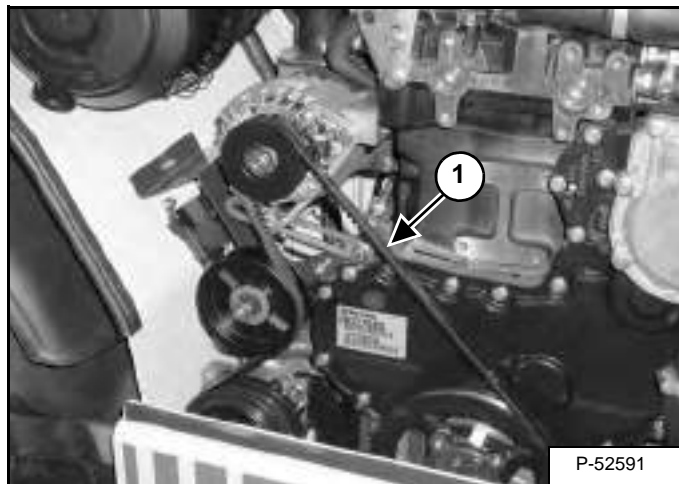

Check the tension on the compressor belt (Item 1) [Figure 80-40-5].

### Cleaning The Condenser

Open the engine cover.

Temporarily remove the air cleaner (See "Filter Element Removal And Installation" on page 80-40-1).

**Figure 80-40-6**

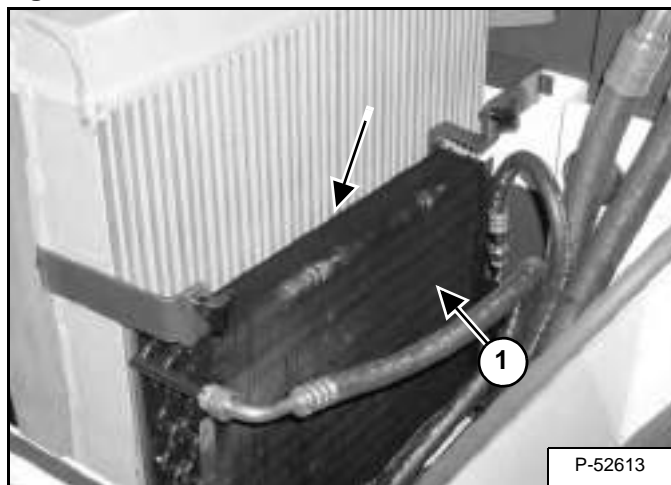

Clean the condenser (Item 1) [Figure 80-40-6] using water or air pressure.

**NOTE:** Clean between the oil cooler and condenser.

## BASIC TROUBLESHOOTING

### Poor A/C Performance

Start the Telescopic Handler, engage the parking brake. Engage the A/C system with the blower fan on high. Run the Telescopic Handler at full RPM for approximately 15 minutes, with the cab door closed.

Figure 80-50-1

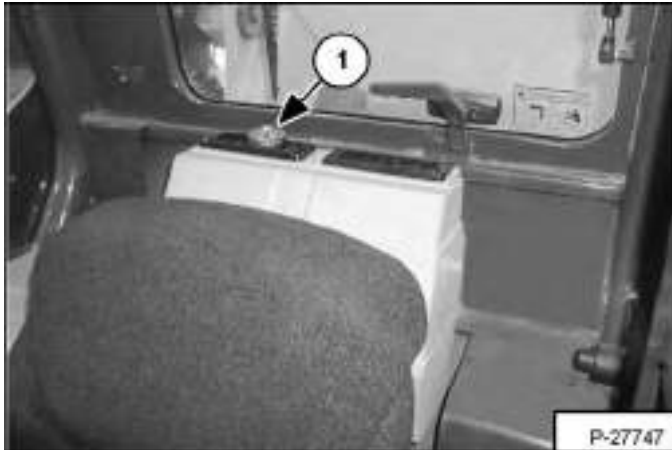

Figure 80-50-2



Check the temperature at the louvers (Item 1) [Figure 80-50-1] with a thermometer [Figure 80-50-2].

The louver temperature should be between 36-53°F (2.2-11,6°C) depending on the amount of humidity in the air.

If the louver temperature is too high (See "SYSTEM TROUBLESHOOTING CHART" on page 80-70-1).

Check the blower fan for proper operation or noise, and replace if necessary (See "EVAPORATOR / BLOWER UNIT" on page 80-150-1).

Check the belt tension on the A/C compressor (See "Compressor Drive Belt Inspection" on page 80-40-2).

Check the A/C condenser for dirt or mud, and clean if necessary (See "CONDENSER" on page 80-120-1).

Inspect the sight glass located on the receiver / drier for air bubbles (See "RECEIVER / DRIER" on page 80-130-1).

### Compressor Drive Belt Inspection

Regularly inspect (weekly) the compressor drive belt for wear.

Open the engine cover.

Remove the belt cover.

Figure 80-50-3

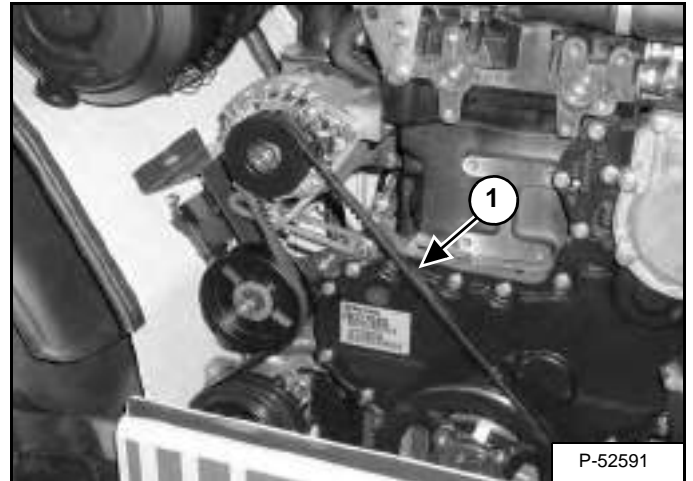

Check the tension on the compressor belt (Item 1) [Figure 80-50-3].

## BASIC TROUBLESHOOTING (CONT'D)

### Checking The Electrical System

Figure 80-50-4

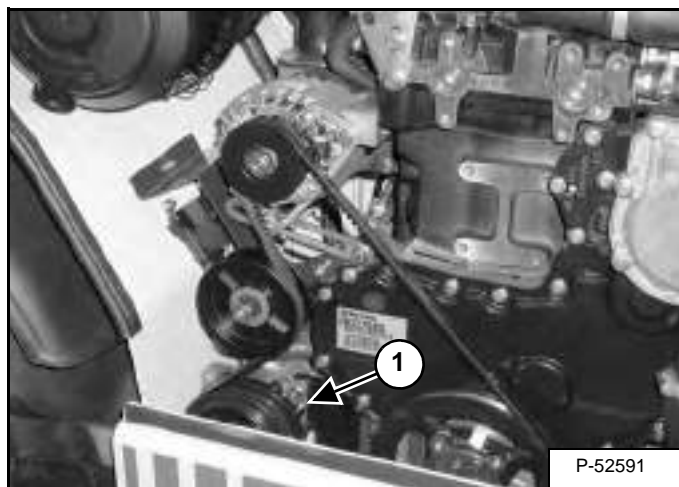

Check to see if the compressor clutch (Item 1) [Figure 80-50-4] is engaging.

Turn the ignition key switch to the RUN position without starting the machine.

Figure 80-50-5



Turn the blower fan switch (Item 1) [Figure 80-50-5] to the first on position, the compressor clutch should make a click sound, which indicates the clutch is engaging.

Figure 80-50-6

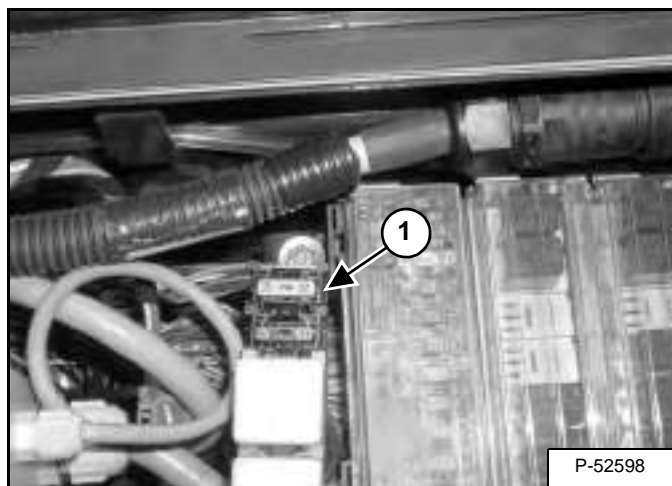

If the compressor clutch does not engage, check the fuse (Item 1) [Figure 80-50-6]. Replace the fuse if needed.

Figure 80-50-7

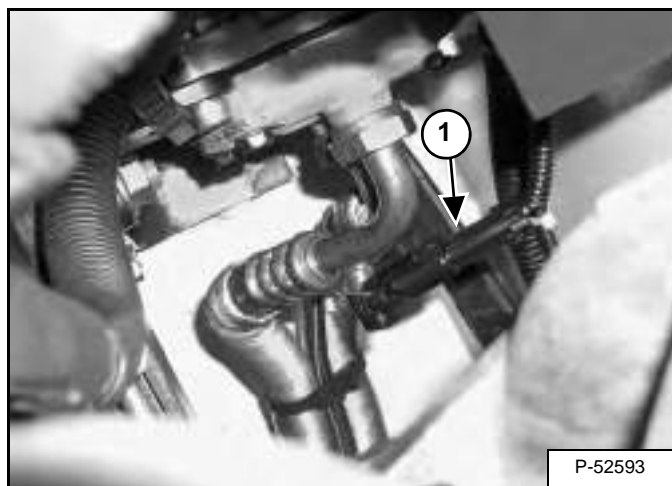

Unplug the connector (Item 1) [Figure 80-50-7] from the compressor.

## BASIC TROUBLESHOOTING (CONT'D)

### Checking The Electrical System (Cont'd)

Figure 80-50-8

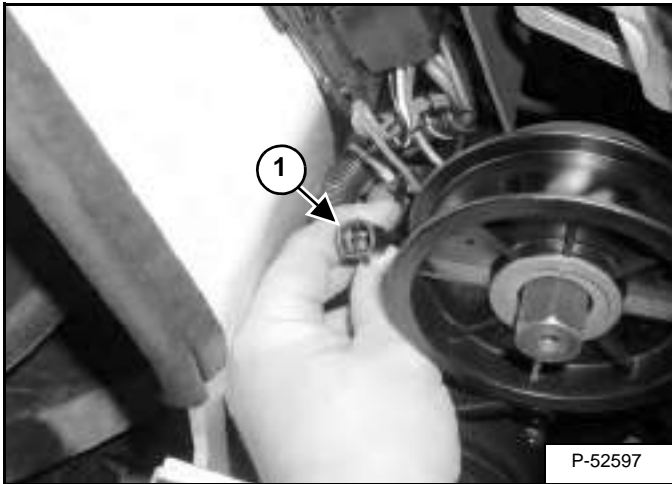

With a multimeter check the resistance to the compressor clutch connector (Item 1) [Figure 80-50-8].

If there is no resistance value replace the compressor clutch (See "COMPRESSOR" on page 80-110-1).

Figure 80-50-9

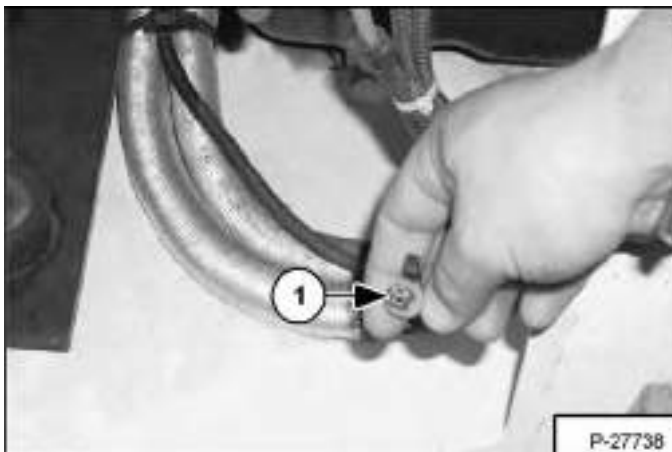

With a multimeter, check the voltage to the compressor clutch at the main harness (Item 1) [Figure 80-50-9].

If there is no power at the clutch, check the wiring harness for broken wires.

If there is no power at the clutch, reconnect the wiring harness to the compressor clutch.

Figure 80-50-10

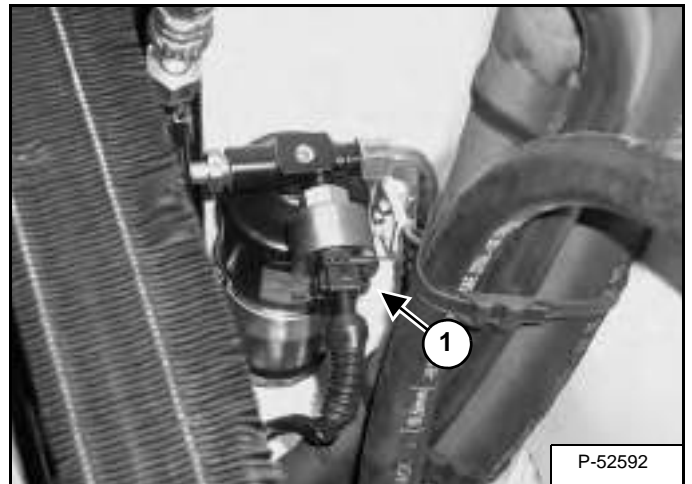

Disconnect the machine harness (Item 1) [Figure 80-50-10] from the pressure switch.

Figure 80-50-11

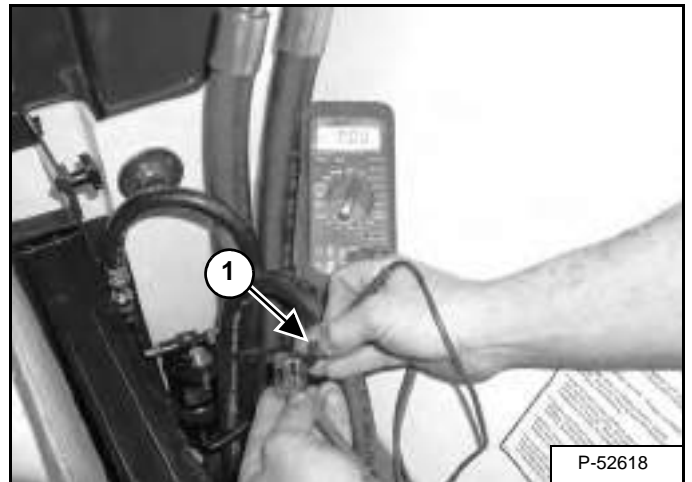

With the key switch to the run position (engine off) and the blower fan switch on the first position. Use a multimeter to check the main harness (Item 1) [Figure 80-50-11] for voltage.

There should be 12 volts. If there is no voltage, check the harness for broken wires.

## BASIC TROUBLESHOOTING (CONT'D)

### Checking The Electrical System (Cont'd)

Figure 80-50-12



If there is voltage at the harness, check the resistance at the pressure switch (Item 1) [Figure 80-50-12].

If there is no resistance value, check for a low refrigerant level.

If good resistance value is observed, the pressure switch is good.

Reconnect the main harness to the pressure switch.

Figure 80-50-13

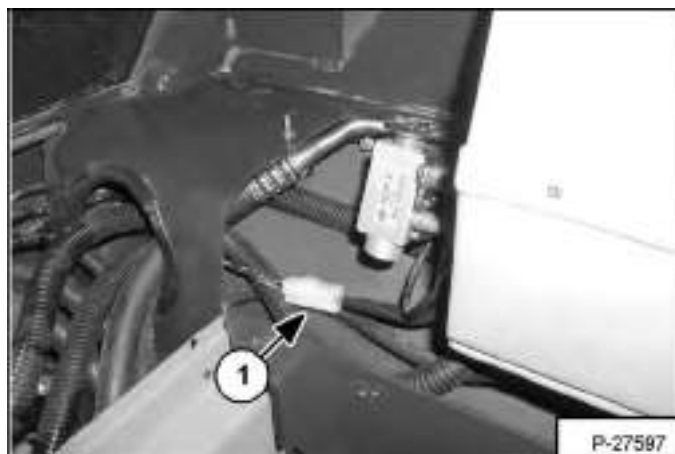

Disconnect the thermostat wiring connector (Item 1) [Figure 80-50-13] from the main harness.

Figure 80-50-14



Check the main harness (Item 1) [Figure 80-50-14] for voltage. The voltage should be 12 volts. If there is no voltage, check the harness for broken wires.

Figure 80-50-15



If there is voltage at the wiring harness, check the thermostat wire (green) for resistance. The resistance value should be 10 ohms at 68° F (20 ° C) [Figure 80-50-15].

If there is no resistance, replace the entire blower fan unit.

## BASIC TROUBLESHOOTING (CONT'D)

### Checking The Electrical System (Cont'd)

Figure 80-50-16

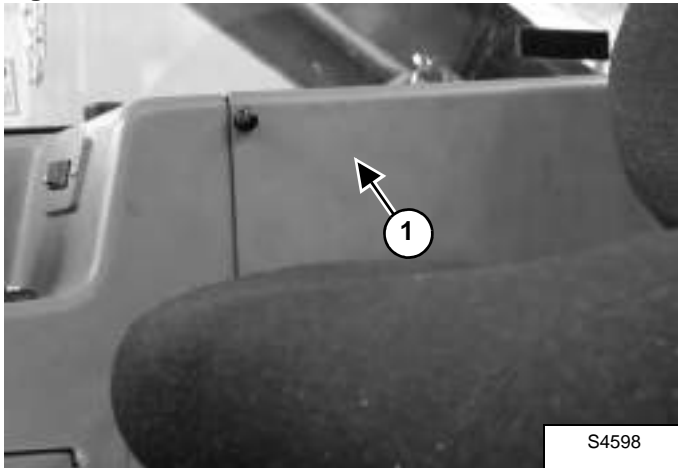

Remove the fuse box cover (Item 1) [Figure 80-50-16].

Figure 80-50-17

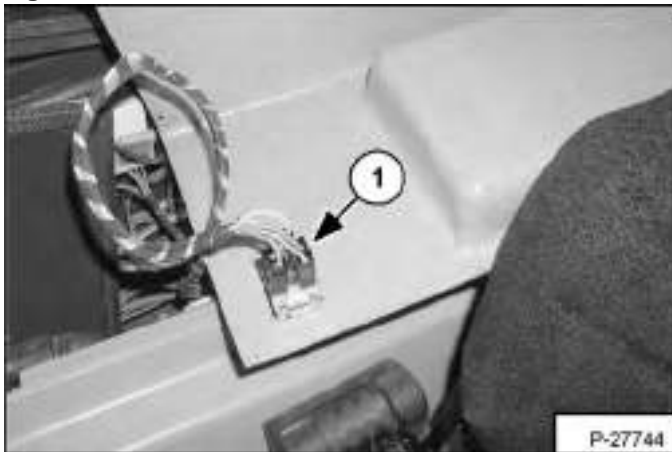

Disconnect the main wire harness connectors (Item 1) [Figure 80-50-17] from the switch.

**NOTE: Mark the wires for correct assembly.**

Figure 80-50-18

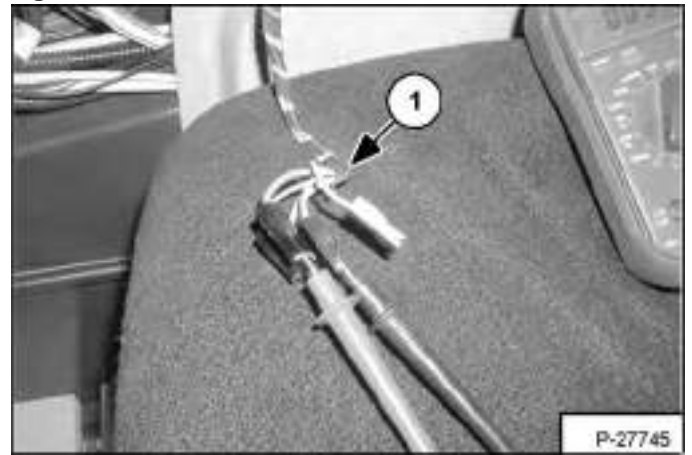

Check the main harness (Item 1) [Figure 80-50-18] for voltage. The voltage should be 12 volts if there is no voltage check the harness for broken wires.

Figure 80-50-19

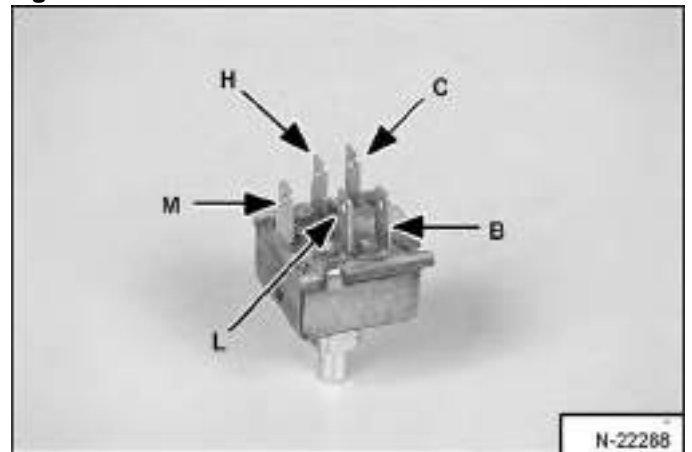

If there is voltage at the main harness check the blower fan switch [Figure 80-50-19] for resistance.

With the switch in the **OFF** position, there should be zero resistance between all terminals.

With the switch in the **1** position, there should be resistance between **C** terminal and the **B** terminal. And also between the **C** terminal and the **L** terminal frame [Figure 80-50-19].

With the switch in the **2** position, there should be resistance between **C** terminal and the **B** terminal. And also between the **C** terminal and the **M** terminal frame [Figure 80-50-19].

With the switch in the **3** position, there should be resistance between **C** terminal and the **B** terminal. And also between the **C** terminal and the **H** terminal frame [Figure 80-50-19].

If any of the above resistance tests fail, replace the blower fan switch.



**Bobcat®**



## GENERAL AIR CONDITIONING SERVICE GUIDELINES

### Compressor Oil

Figure 80-60-1

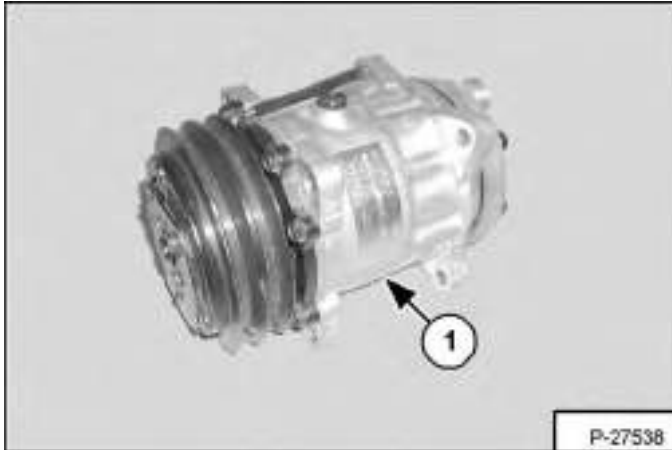

The compressor (Item 1) [Figure 80-60-1] is factory filled with 150-170 cc's of PAG oil (Poly Alkelene Glycol).

Unlike engine oil, it is not necessary to frequently check or change the compressor oil.

It is necessary to check, replenish or replace the compressor oil in the following cases:

1. When the evaporator, condenser or receiver-drier is replaced.
2. When refrigerant has leaked from the system.
3. When refrigerant is suddenly released from the cooling cycle.
4. When any related problems occur in the cooling cycle.

When one of the components (the evaporator, condenser or receiver-drier) is replaced, **one ounce** (30 cc) of PAG oil should be added for each component replaced.

If the A/C compressor is changed, no oil should be added to the system, because the compressor comes factory filled with oil.

**NOTE: Only PAG oil should be used. Never mix R-12 and R-134a Oils.**

### Compressor Oil Check

The compressor oil should be checked as follows when oil is being added to an in service machine.

There is a close affinity between oil and refrigerant. During normal operation, part of the oil circulates with the refrigerant in the system. therefore, when checking the amount of oil in the system or replacing any system component, the compressor must be run-in advance to insure return of oil to the compressor.

If the amount of refrigerant in the system has decreased, charge the system (See "SYSTEM CHARGING AND RECLAMATION" on page 80-100-1).

Open the cab door and windows.

Run the blower fan at maximum speed.

Run the compressor for at least 20 minutes at 800-1200 RPM.

Remove the compressor from the machine (See "COMPRESSOR" on page 80-110-1).

Figure 80-60-2

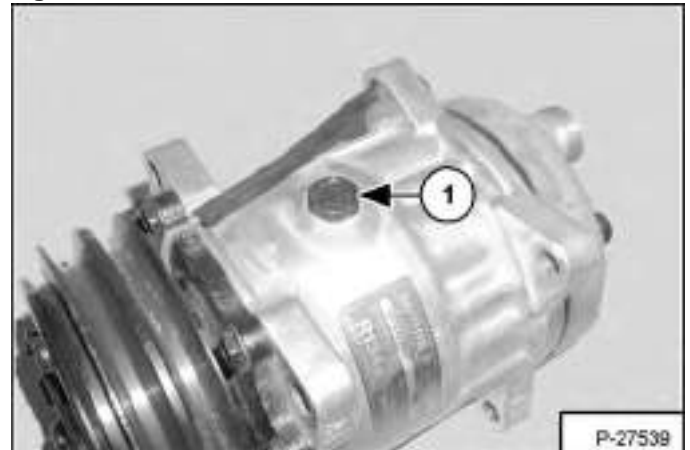
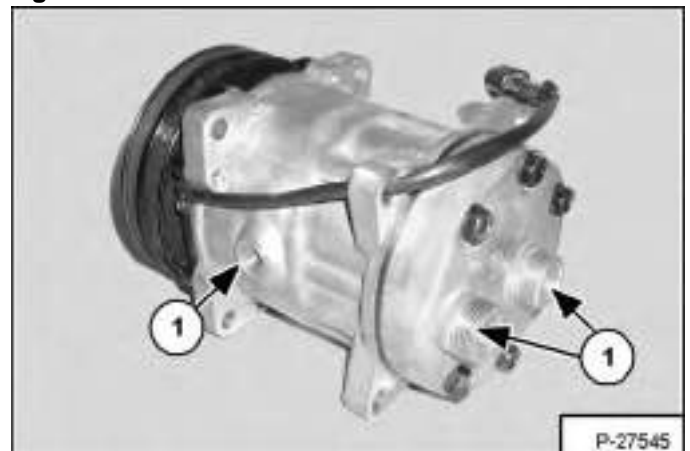

Figure 80-60-3



Remove the oil drain plug (Item 1) [Figure 80-60-2] and drain the oil through the connectors and the oil drain hole (Item 1) [Figure 80-60-3].

**Installation:** Tighten the oil drain plug to 9.4-10.8 ft.-lb. (13-15 N•m) torque.

Compressor Oil Check (Cont'd)

Figure 80-60-4

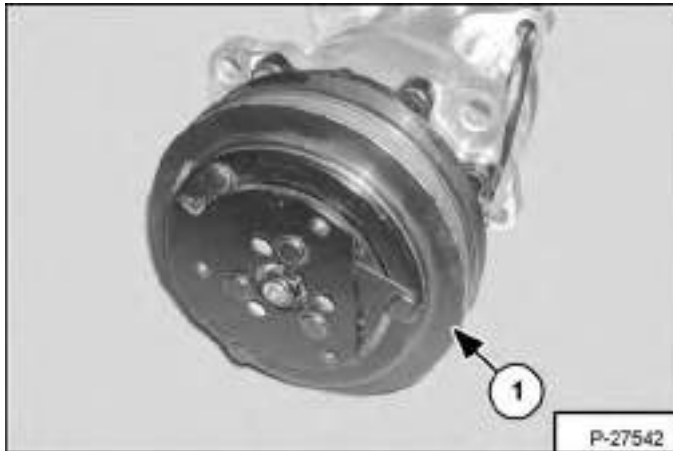

**NOTE:** After draining the oil through the drain hole and the connectors, extract the remaining oil through the discharge-side connector by rotating the drive pulley (Item 1) [Figure 80-60-4] several times by hand.

Measure the drained oil in a measuring cylinder.

Check the oil for contamination, dirt, metal shavings, or varnish color, discard the oil if contaminated.

**NOTE:** If metal shavings are found in the compressor oil, replace the complete compressor assembly.

Figure 80-60-5

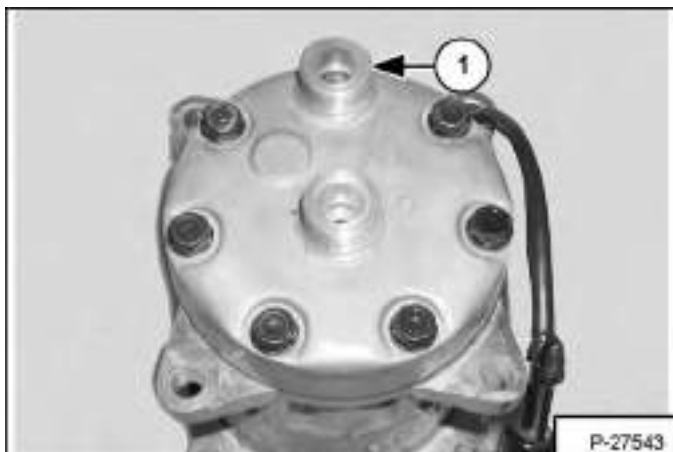

Add new compressor oil through the suction side connector (Item 1) [Figure 80-60-5].

**Installation:** Add 150-170 cc's of PAG oil.

**NOTE:** The suction port on the compressor is marked with an S and is the large port on the compressor.

Figure 80-60-6

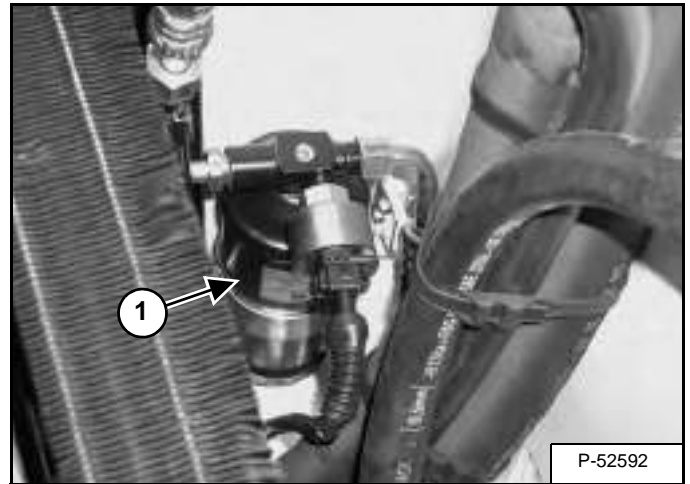

Whenever the A/C system is opened to the atmosphere or there has been a leak in the system, the receiver/drier (Item 1) [Figure 80-60-6] must be changed.

Never leave hose fittings, compressor fittings or components uncapped while working on the A/C system.

## SYSTEM TROUBLESHOOTING CHART

Blower motor does not operate

	POSSIBLE CAUSE	INSPECTION	SOLUTION
1.	Blown Fuse.	Inspect the fuse / wiring.	Replace fuse / repair wiring.
2.	Broken wiring or bad connection.	Check the fan motor ground and connectors.	Repair the wiring or connector.
3.	Fan motor malfunction.	Check the lead wires from the motor with a circuit tester.	Replace Evaporator / Blower Unit.
4.	Fan motor switch malfunction.	Check power into and out of the fan switch.	Replace Fan Switch.

Blower motor operates normally, but air flow is insufficient

	POSSIBLE CAUSE	INSPECTION	SOLUTION
1.	Evaporator inlet obstruction	Check evaporator for plugging.	Remove obstruction and clean evaporator fins with air or water.
2.	Defective thermo. switch (frozen evaporator).	Check thermostat using a circuit tester.	Replace Evaporator / Blower unit.

Insufficient cooling although air flow and compressor operation are normal

	POSSIBLE CAUSE	INSPECTION	SOLUTION
1.	System low on refrigerant.	The high side pressure will be low and bubbles may be present in sight glass on receive drier.	Repair any leaks and recharge the refrigerant to the correct level.
2.	Excessive refrigerant.	The high pressure side pressure will be high.	Use refrigerant recovery equipment to capture excess refrigerant. Charge to the correct refrigerant level.

The compressor does not operate at all, or operates improperly

	POSSIBLE CAUSE	INSPECTION	SOLUTION
1.	Loose drive belt.	The belt is vibrating or oscillating.	Adjust tension.
2.	Internal compressor malfunction.	The compressor is locked up and the belt slips.	Replace compressor.
		Magnetic clutch related	
3.	Low battery voltage.	Clutch slips.	Recharge the battery.
4.	Faulty coil.	Clutch slips.	Replace the magnetic clutch.
5.	Oil on the clutch surface.	Clutch slips.	Replace or clean the clutch surface.
6.	Open coil.	Clutch does not engage and there is not reading when a circuit tester is connected between the coil and terminals.	Replace clutch.
7.	Broken wiring or poor ground.	Clutch will not engage. Inspect the ground and connections.	Repair.
8.	Wiring harness components.	Test the conductance of the pressure switch, thermostat, Relay, etc.	Check operation.

## SYSTEM TROUBLESHOOTING CHART (CONT'D)

### Gauge Pressure Related Troubleshooting

Normal compressor suction (low side) and discharge (high side) pressure at ambient temperatures of 86-96 degrees F (30-38 degrees C) and compressor speed of approximately 2000 RPM are:

**High pressure side pressure: 210-265 PSI**

**Low pressure side pressure: 15-33 PSI**

**As a rule of thumb the high side pressure will be around eight times greater than the low side pressure**

POSSIBLE CAUSE	INSPECTION	SOLUTION
<b>Low pressure side Too high.</b>	The low pressure side pressure normally becomes too high when the high pressure side pressure is too high. As this is explained below, the following inspection is only used when the low pressure side is too high.	
1. Expansion valve opens too far.	Frost is present on the suction hose.	Replace expansion valve
2. Defective compressor	The high and low pressure side gauge pressures equalize when the magnetic clutch is disengaged.	Replace compressor.
<b>Low pressure side Too low.</b>		
1. Low refrigerant charge	The high side pressure will be low and bubbles may be present in sight glass on receiver drier.	Repair any leaks and recharge the refrigerant to the correct level.
2. Clogged or closed expansion valve.	The expansion valve's inlet side is frosted. Moisture or other Contaminants can be the cause.	Clean or replace the expansion Valve.
3. Restriction between drier and expansion valve.	Frost on the line between drier and expansion valve. A Negative low pressure reading may be shown.	Flush system or replace hose.
4. Thermostat malfunction.	The evaporator is frozen.	Replace Evaporator / Blower unit.
<b>High pressure side Too high.</b>		
1. Poor condenser performance.	Dirty or clogged condenser fins. Condenser fans not Operating.	Clean fins, and / or repair the fan.
2. Excessive refrigerant.	The high pressure side pressure will be high.	Use refrigerant recovery equipment to capture excess refrigerant. Charge to the correct refrigerant level.
3. Excessive oil charge	The high pressure side will be high.	Evacuate system. Remove oil from condenser and compressor. Measure oil from compressor and add correct oil charge back into compressor. Flush system with nitrogen. Replace drier.
4. Air in system.	Pressure is high on both high and low sides.	Evacuate and recharge with Refrigerant.
5. Restriction in drier, condenser or high pressure line.	High pressure side will be high, and low pressure side will be low.	Evacuate and flush system replacing defective parts.

---

**SYSTEM TROUBLESHOOTING CHART (CONT'D)****Gauge Pressure Related Troubleshooting (Cont'd)**

<b>POSSIBLE CAUSE</b>	<b>INSPECTION</b>	<b>SOLUTION</b>
<b>High pressure side Too low.</b>		
1. Low refrigerant charge	The high side pressure will be low and bubbles may be present in sight glass on receiver drier.	Repair any leaks and recharge the refrigerant to the correct level.
<b>System pressures Equal</b>		
1. Clutch not operating	See magnetic clutch related topics above.	
2. Compressor not pumping.	Equal high and low pressures.	Replace compressor.



**Bobcat®**

## TEMPERATURE / PRESSURE

### Chart

NORMAL EVAPORATOR RANGE	
TEMP F.	PSIG
16	15.69
18	17.04
20	18.43
22	19.87
24	21.35
26	22.88
28	24.47
30	26.10
32	27.79
34	29.52
36	31.32
38	33.17
40	35.07
42	37.03
44	39.05
45	40.09
50	45.48
55	51.27
60	57.47
65	64.10
70	71.19
75	78.75
80	86.80
85	95.40
90	104.40
91	106.30
92	108.20

### Evaporator

Pressures represent gas temperatures inside the coil, not the coil surface. For an estimate of the temperature of the air coming off the coil add 8-10 degrees F. to the temperature on the chart.

### Condenser

Temperatures are not ambient temperatures but condensing temperatures. Add 40 degrees F. to the ambient temperature to get the condensing temperature and then refer to the pressure chart to see appropriate pressure for ambient temperature.

Example: Ambient Temperature=90 degrees F.  
90 degrees F.  
+40 degrees F.  
130 degrees F. condenser temperature=200 psi

Conditions and pressures will vary from system to system.

NORMAL CONDENSER RANGE	
TEMP F.	PSIG
93	110.20
94	112.10
95	114.10
100	124.30
102	128.50
104	132.90
106	137.30
108	141.90
110	146.50
112	151.30
114	156.10
116	161.10
118	166.10
120	171.30
122	176.60
124	182.00
126	187.50
128	193.10
130	198.90
135	213.70
140	229.40
145	245.80
150	263.00
155	281.10
160	300.10
165	320.10
170	340.80



**Bobcat®**



## AIR CONDITIONING SERVICE

### Chart

Service Company / Phone Number: Date: Machine Model: Machine Serial Number: Machine Hours:	Machine Dealer: Customer:		
<b>Pre Service Conditions</b>	15 Minutes	30 Minutes	Notes
Ambient Temperature:			
Louver Temperature:			
Cab Temperature at Head Position:			
Temperature into Condenser:			
High Side Pressure			
Low Side Pressure			
Ambient Humidity			
Observations:			
Explain services required:			
<b>Post Service Conditions</b>	15 Minutes	30 Minutes	Notes
Ambient Temperature:			
Louver Temperature:			
Cab Temperature at Head Position:			
Temperature into Condenser:			
High Side Pressure			
Low Side Pressure			
Ambient Humidity			
Observations:			



**Bobcat®**

## SYSTEM CHARGING AND RECLAMATION

### Reclamation Procedure

Figure 80-100-1

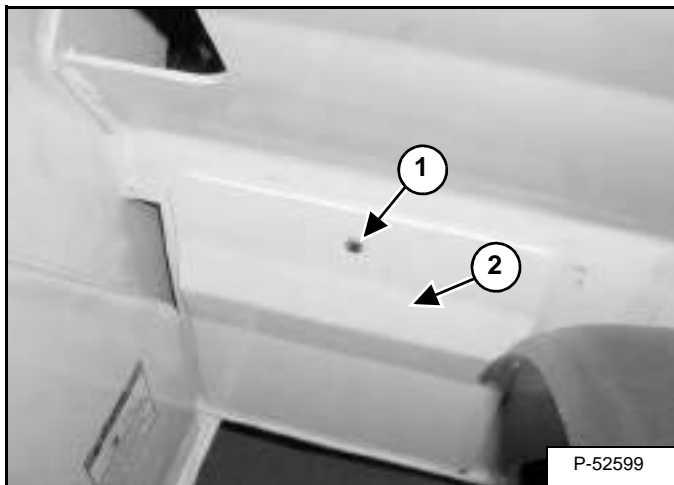

Open the engine cover.

Remove the access cover mounting bolt (Item 1). Remove the access cover (Item 2) [Figure 80-100-1].

Figure 80-100-2

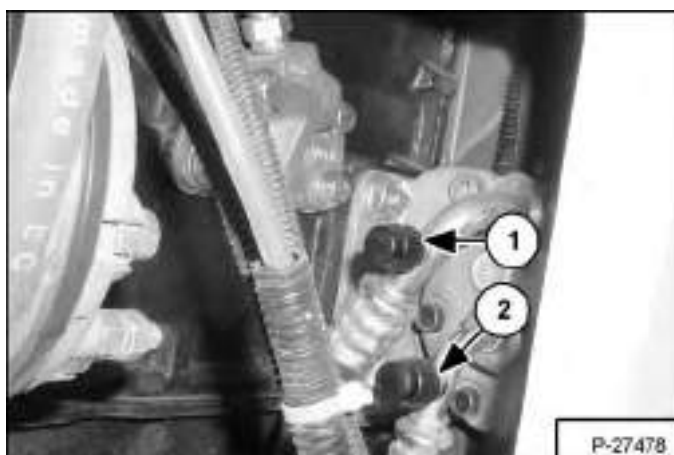

Locate the low pressure port (Item 1) and high pressure port (Item 2) [Figure 80-100-2] on the back side of the compressor.

## WARNING

In the event of a leak, wear safety goggles. Escaping refrigerant can cause severe injuries to eyes. In contact with a flame, R134a refrigerant gives a toxic gas.

W-2371-0500

**NOTE:** This test is run with the engine OFF, and the A/C switch in the OFF position.

Figure 80-100-3



**NOTE:** Before reclaiming a refrigeration system, it is recommended to identify the type of refrigerant that is in the A/C system and if it is pure enough to use. The tool MEL 1592, Refrigerant Identifier (Item 1) [Figure 80-100-3] will determine, the kind of refrigerant and any possible harmful or dangerous substances that may be present in the system. Thus preventing mixing of dangerous material with your reclaimed R-134a in your reclaimer, and further contamination to other A/C systems that are reclaimed and charged from your MEL 1581 Recovery / Recycling / Recharging Machine.

Remove the protective cap and connect the refrigerant identifier to the low pressure hose (Item 1) [Figure 80-100-2].

Connect the refrigerant identifier to its power source.

## SYSTEM CHARGING AND RECLAMATION (CONT'D)

### Reclamation Procedure (Cont'd)

Figure 80-100-4



Follow the steps displayed on the refrigerant identifier screen [Figure 80-100-4].

Allow 2 minutes for the refrigerant identifier to display the type of refrigerant and air content. An alarm will sound if potentially flammable hydrocarbons are present and will also indicate on the visual display.

Disconnect the refrigerant identifier from the A/C.

If the refrigerant is dangerous or flammable, it must be evacuated from the A/C system into a separate container and properly and safely disposed of.

If R134a is found, evacuate the system.

**IMPORTANT: Only A/C trained technicians should perform the reclaiming and recharging procedure.**

## **WARNING**

HFC 134A refrigerant can be dangerous if not properly handled. Liquid 134A may cause blindness if it contacts the eyes and may cause serious frostbite if it contacts the skin.

- Gaseous 134A becomes lethal (phosgene) gas when it contacts open flame or very hot substances.
- **NEVER SMOKE** when there is the possibility of even small amounts of 134A in the air.

Any servicing work that involves release or addition of 134A to the system must be done by a competent refrigeration dealer who has the proper equipment, knowledge, and experience to service refrigeration equipment.

W-2373-0500

Figure 80-100-5



Use an approved recovery / charging unit [Figure 80-100-5] to evacuate the system.

Connect the reclaimer to the A/C charge ports.

## SYSTEM CHARGING AND RECLAMATION (CONT'D)

### Reclamation Procedure (Cont'd)

Figure 80-100-6

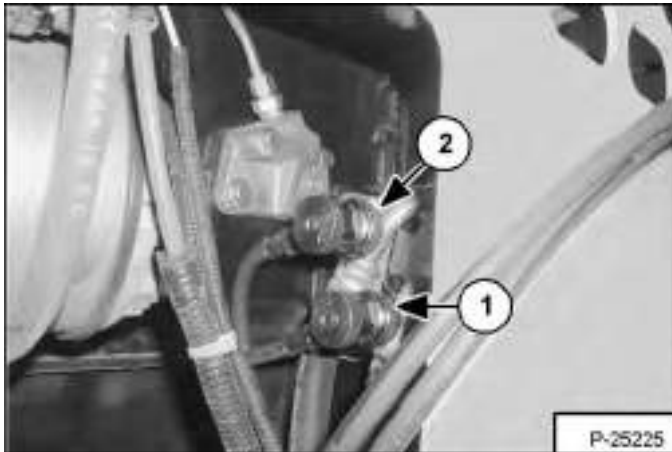

Connect the Red hose (Item 1) [Figure 80-100-6] to the high pressure port and open the valve.

Connect the Blue hose (Item 2) [Figure 80-100-6] to the low pressure port and open the valve.

Figure 80-100-7



Turn the reclaimer unit [Figure 80-100-7] to the ON position and follow the on screen instructions.

Figure 80-100-8

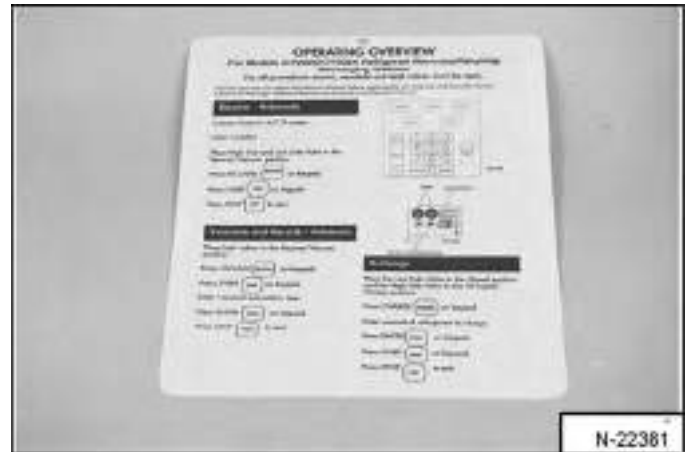

**NOTE:** The reclaimer unit, has a complete step by step set of instructions [Figure 80-100-8] to follow for reclamation and recharging of the A/C system. a trained technician should follow these instructions as they may very slightly depending on the model and brand of reclaimer used.

## SYSTEM CHARGING AND RECLAMATION (CONT'D)

### Charging Procedure With A Manifold Gauge Set

Open the hood.

# ! WARNING

In the event of a leak, wear safety goggles. Escaping refrigerant can cause severe injuries to eyes. In contact with a flame, R134a refrigerant gives a toxic gas.

W-2371-0500

Figure 80-100-9

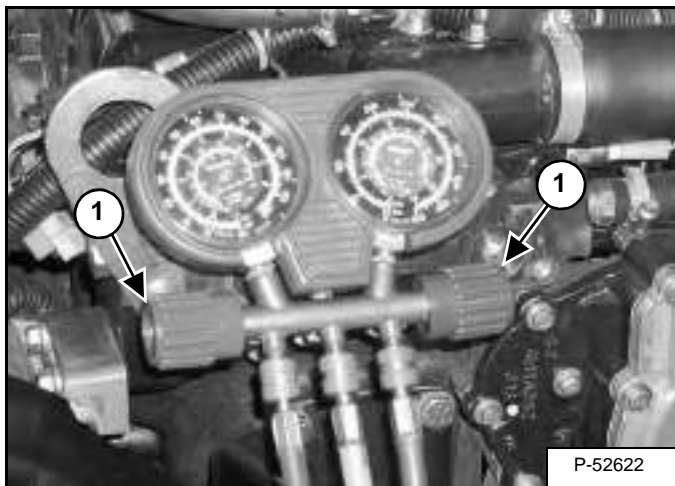

Check to see that the hand valves (Item 1) [Figure 80-100-9] are closed on the manifold gauge set.

If there is any refrigerant in the A/C system, it must be recovered by an approved A/C reclamation procedure. (See "Reclamation Procedure" on page 80-100-1)

Connect the gauges to the A/C charge ports.

Figure 80-100-10

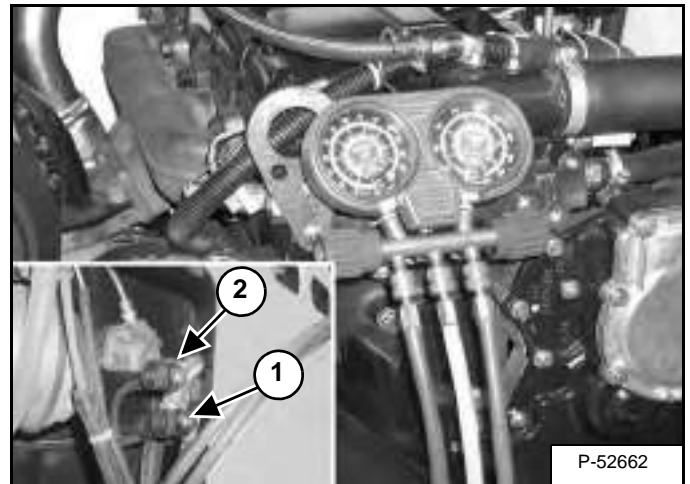

Connect the Red hose (Item 1) [Figure 80-100-10] to the high pressure port and open the valve.

Connect the Blue hose (Item 2) [Figure 80-100-10] to the low pressure port and open the valve.

Figure 80-100-11

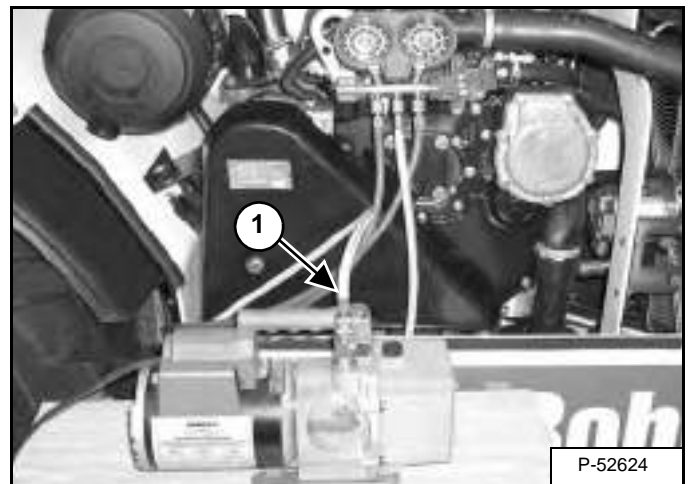

Connect the Yellow hose (Item 1) [Figure 80-100-11] to the vacuum pump.

## SYSTEM CHARGING AND RECLAMATION (CONT'D)

### Charging Procedure With A Manifold Gauge Set (Cont'd)

Figure 80-100-12

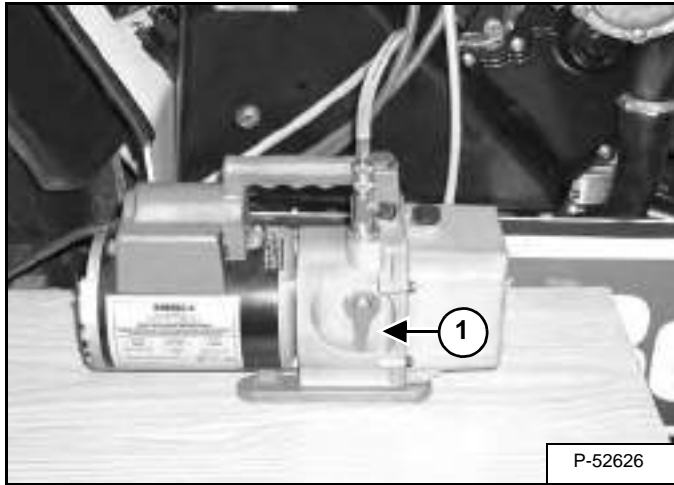

Start the vacuum pump and open ISO-valve (Item 1) [Figure 80-100-12] on the vacuum pump.

Run the vacuum pump for at least 5-10 minutes to insure that a vacuum has been pulled on the system.

Close the ISO-valve (Item 1) [Figure 80-100-12] (which isolates the vacuum pump from the A/C system) and turn OFF the vacuum pump.

### Charging Procedure

Figure 80-100-13

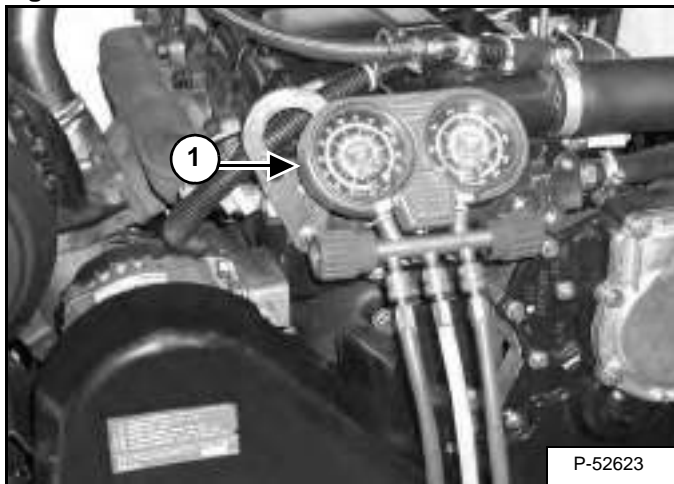

Note vacuum pressure indicated on the low pressure (Blue) gauge (Item 1) [Figure 80-100-13]. Let stand for 5-10 minutes and recheck the pressure for changes.

If the pressure drops, this may be an indication of a leak in the A/C system.

Determine the problem with the A/C system and repair it.

Figure 80-100-14

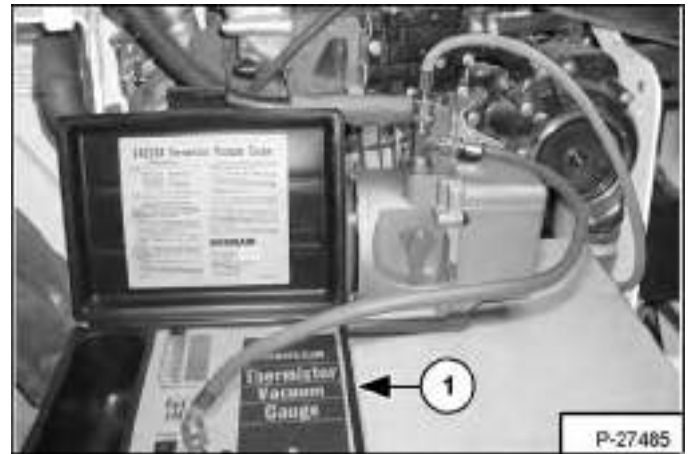

A thermistor vacuum gauge (Item 1) [Figure 80-100-14] can be used to determine the critical vacuum level during evacuation. It is a solid state instrument that constantly monitors and visually indicates the vacuum level.

The thermistor vacuum gauge is used with the vacuum pump [Figure 80-100-14].

Start the vacuum pump and open ISO-valve on the vacuum pump.

Be sure that both hand valves, and both charge port valves are open.

Run the vacuum pump for at least 45 minutes to insure that all the moisture is boiled out of the system.

Stop the vacuum pump and close the ISO-valve on the vacuum pump.

Close both hand valves on the manifold gauge set and remove the yellow hose from the vacuum pump that goes to the manifold gauge set.

Remove the vacuum pump and thermistor vacuum gauge.

## SYSTEM CHARGING AND RECLAMATION (CONT'D)

### Charging Procedure (Cont'd)

Figure 80-100-15

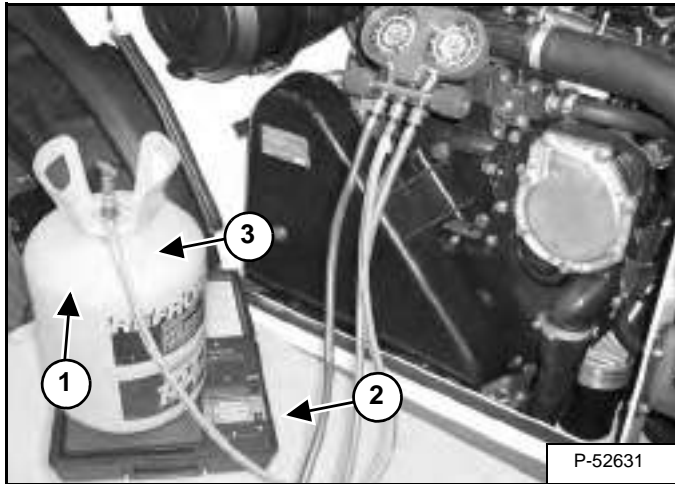

Place a refrigerant container with R134a (Item 1) on a charging scale (Item 2) [Figure 80-100-15] and zero out the scale.

Connect the yellow hose (Item 3) [Figure 80-100-15] from the manifold gauge set to the valve on the refrigerant tank.

Figure 80-100-16

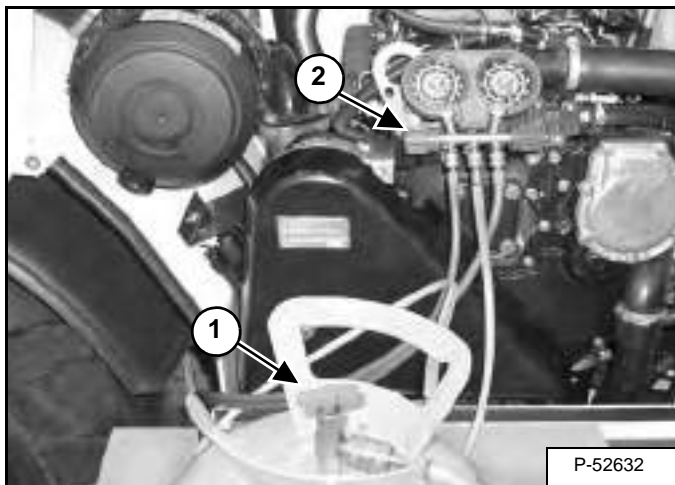

Open the valve on the refrigerant container (Item 1) and open the low pressure hand valve (Blue) (Item 2) [Figure 80-100-16] on the manifold gauge set. Allow the vacuum to pull in the refrigerant until the pressure stabilizes.

Figure 80-100-17



Turn the A/C fan switch (Item 1) [Figure 80-100-17] to HIGH position.

Start the machine, and run at medium speed.

Watch the scale and run system until the predetermined amount of refrigerant is added to the A/C system.

The A/C system holds 1.76 lb. (0,800 Kg) of refrigerant.

Turn off the valve on the refrigerant container, and hand valves on the manifold gauge set.

Turn off the engine and remove the A/C charging equipment from the machine.

Install access cover.

Close the engine cover.



## COMPRESSOR

### Removal And Installation

Evacuate the A/C system (See "Reclamation Procedure" on page 80-100-1).

Remove the alternator (See "Removal And Installation" on page 60-40-1).

Remove the compressor belt.

Figure 80-110-1

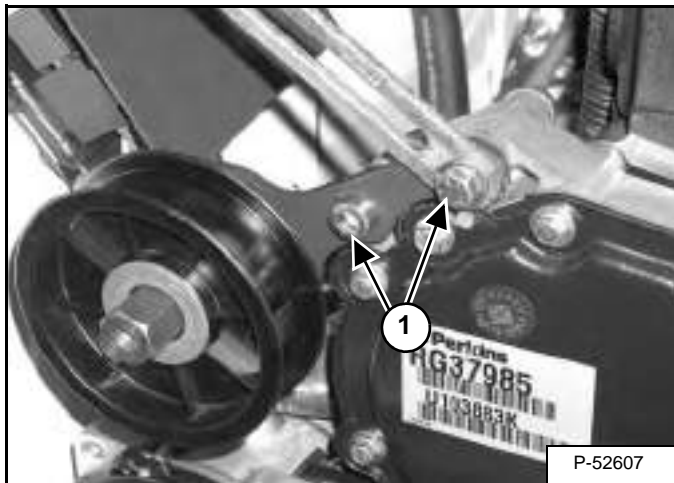

Remove the two tensioner pulley mount belts (Item 1) [Figure 80-110-1]. Remove the pulley assembly.

Figure 80-110-2

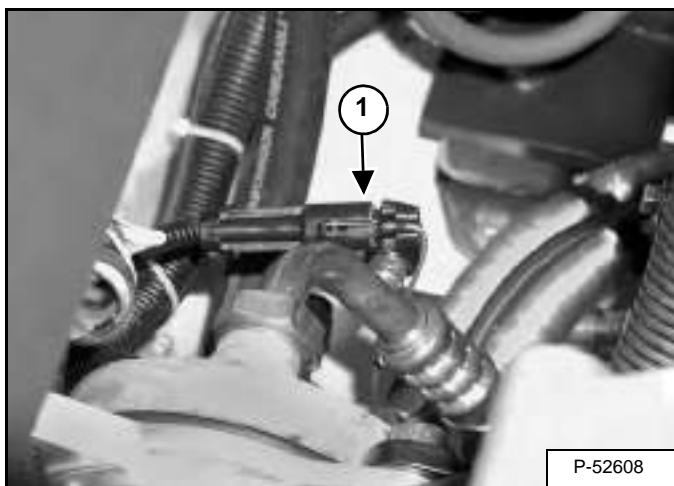

Unplug the connector (Item 1) [Figure 80-110-2] from the compressor.

Mark the compressor hoses for correct installation.



In the event of a leak, wear safety goggles. Escaping refrigerant can cause severe injuries to eyes. In contact with a flame, R134a refrigerant gives a toxic gas.

W-2371-0500

Figure 80-110-3

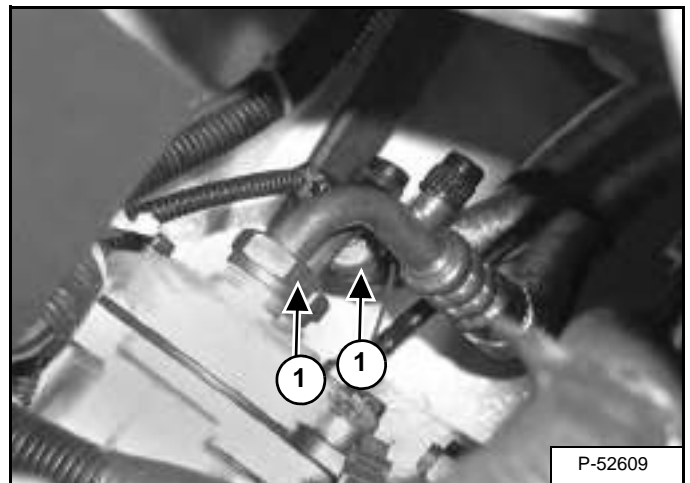

Remove the compressor hoses (Item 1) [Figure 80-110-3].

**Installation:** Tighten the hoses to 22 ft.-lb. (29,8 N•m) torque.

Cap and plug the hoses and fittings with the proper A/C caps and plugs.

Figure 80-110-4

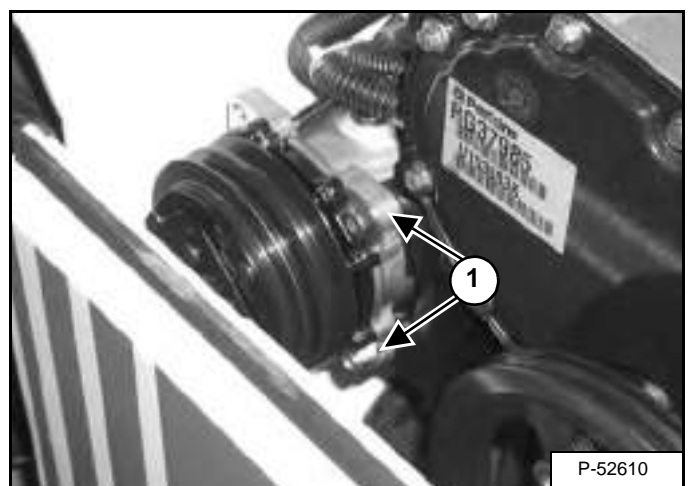

Remove the mount bolts (Item 1) [Figure 80-110-4].

## COMPRESSOR (CONT'D)

### Compressor Clutch Disassembly And Assembly

Figure 80-110-5

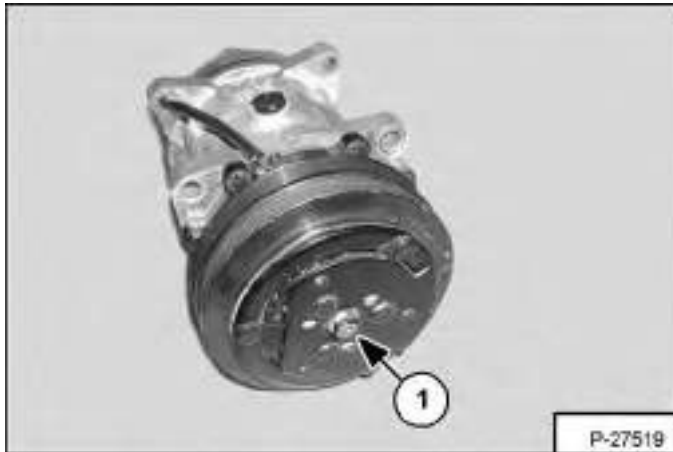

Remove the center armature nut (Item 1) [Figure 80-110-5].

**Assembly:** Tighten the armature nut to 8 ft.-lb. (12 N•m).

Figure 80-110-6

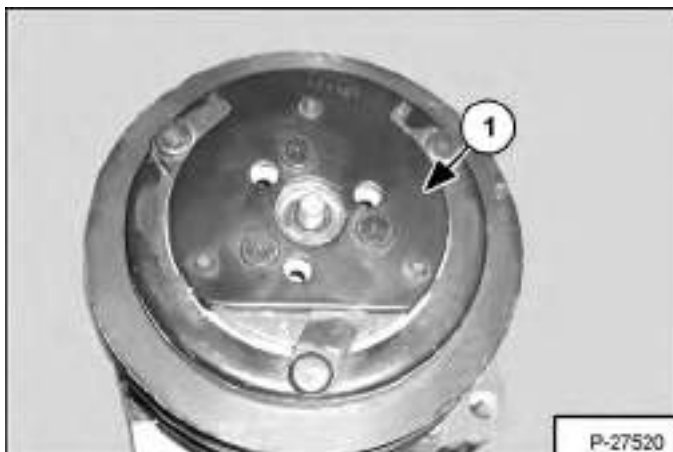

To remove the armature plate (Item 1) [Figure 80-110-6] from the clutch face you must make an armature plate puller.

Figure 80-110-7

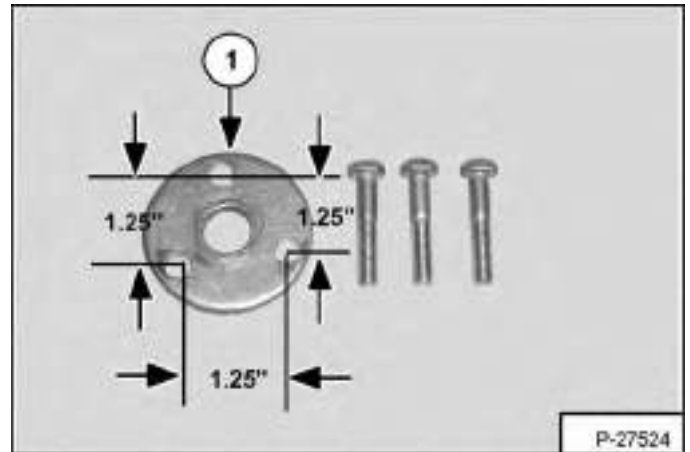

The armature plate puller (Item 1) [Figure 80-110-7] can be constructed by drilling three 0.315 inch (8 mm) holes in a flat circular plate, located 1.25 inches (31,75 mm) apart.

Figure 80-110-8

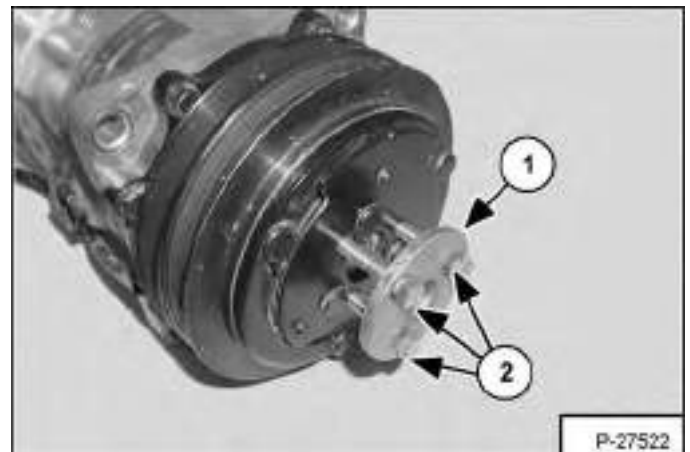

Attach the armature puller plate (Item 1) to the armature plate using the three bolts (Item 2) [Figure 80-110-8].

## COMPRESSOR (CONT'D)

### Compressor Clutch Disassembly And Assembly (Cont'd)

Figure 80-110-9

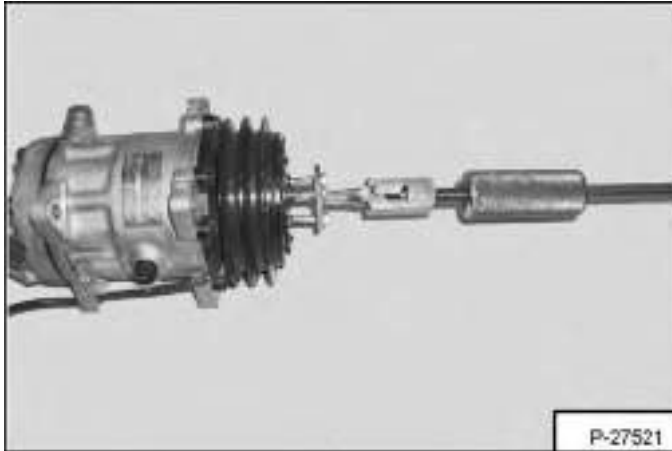

Attach a slide hammer puller to the armature puller tool [Figure 80-110-9].

Figure 80-110-10

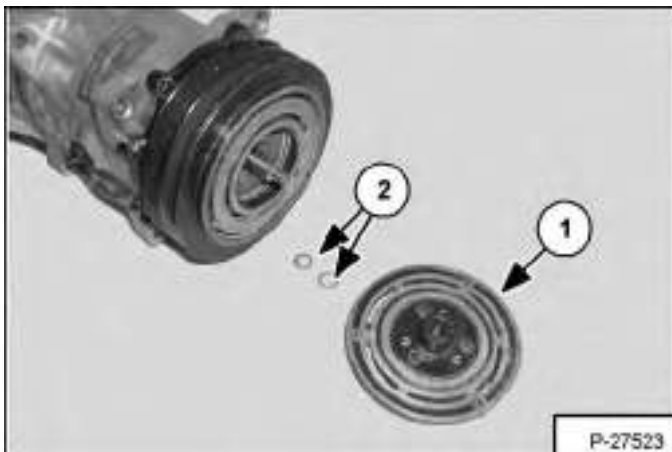

Remove the armature plate (Item 1) [Figure 80-110-10] from the compressor clutch.

Remove the shims (Item 2) [Figure 80-110-10] from the armature shaft or armature plate.

**Assembly:** Insure that the clutch has the correct clearance by adding the shims (Item 2) [Figure 80-110-10].

The specified clearance for the clutch is 0.01-0.02 in. (0.3-0.6 mm) adjusting shims are available in the following thicknesses.

- 0.0039 in. (0.1 mm)
- 0.0118 in. (0.3 mm)
- 0.0197 in. (0.5 mm)

Figure 80-110-11

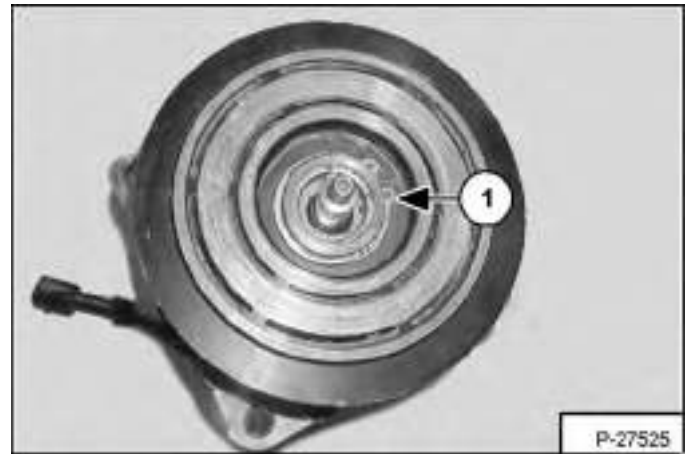

Remove the snap ring (Item 1) [Figure 80-110-11] from the pulley assembly.

Figure 80-110-12

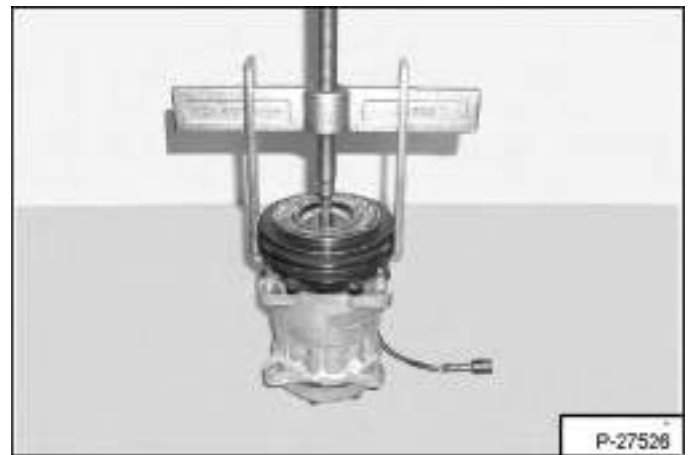

Remove the pulley from the compressor [Figure 80-110-12].

## COMPRESSOR (CONT'D)

### Compressor Clutch Disassembly And Assembly (Cont'd)

Figure 80-110-13



The pulley assembly and bearing [Figure 80-110-13] must be replaced as a complete unit.

Figure 80-110-14

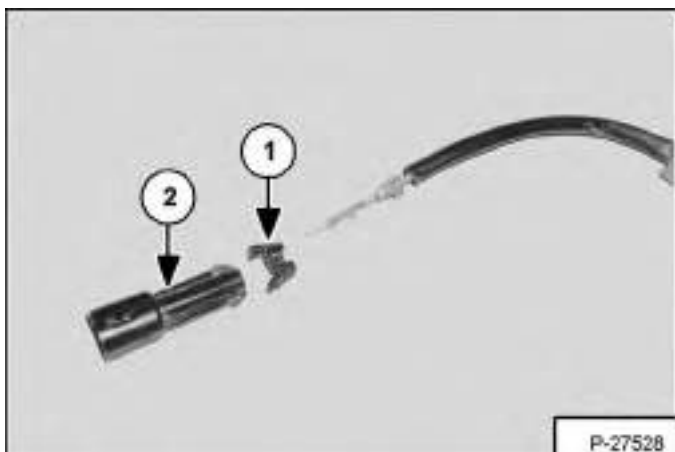

Remove the lock (Item 1) and connector (Item 2) [Figure 80-110-14] from the compressor harness.

Figure 80-110-15

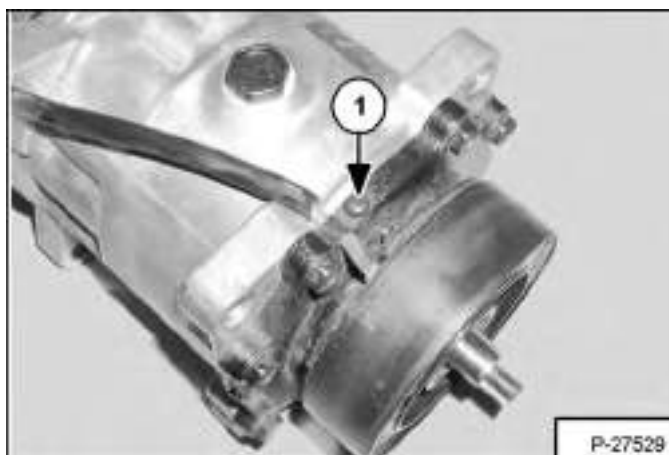

Remove the harness retainer screw assembly (Item 1) [Figure 80-110-15].

Figure 80-110-16

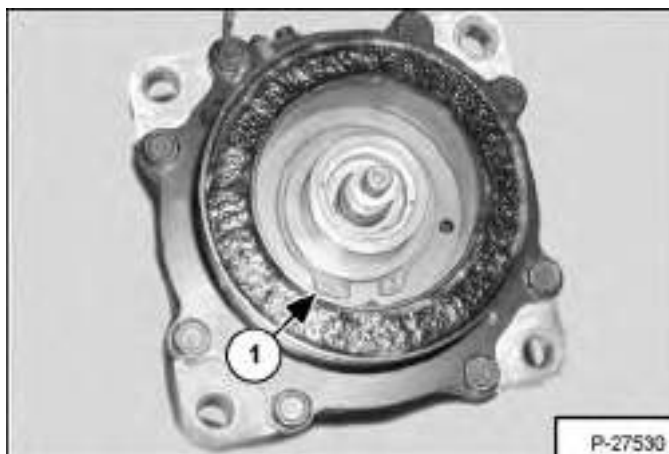

Remove the snap ring (Item 1) [Figure 80-110-16] from the coil.

---

## COMPRESSOR (CONT'D)

### Compressor Clutch Disassembly And Assembly (Cont'd)

Figure 80-110-17

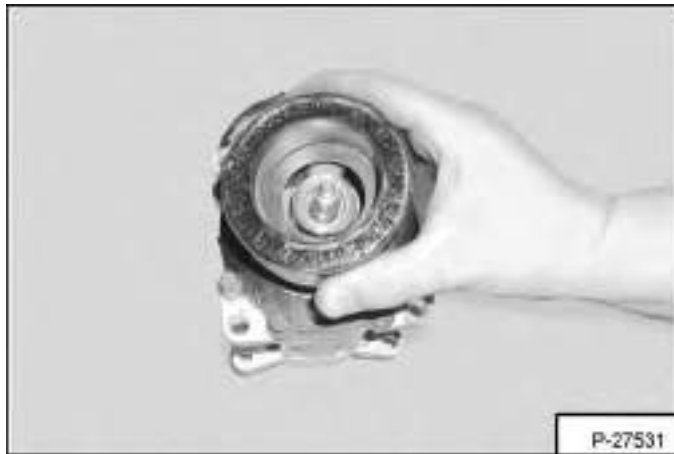

Remove the coil from the compressor [Figure 80-110-17].

Figure 80-110-18



The compressor [Figure 80-110-18] must be replaced as a complete unit.



**Bobcat®**

## CONDENSER

### Removal And Installation

Remove the refrigerant from the A/C system (See "Reclamation Procedure" on page 80-100-1).

# ! WARNING

In the event of a leak, wear safety goggles. Escaping refrigerant can cause severe injuries to eyes. In contact with a flame, R134a refrigerant gives a toxic gas.

W-2371-0500

Figure 80-120-1

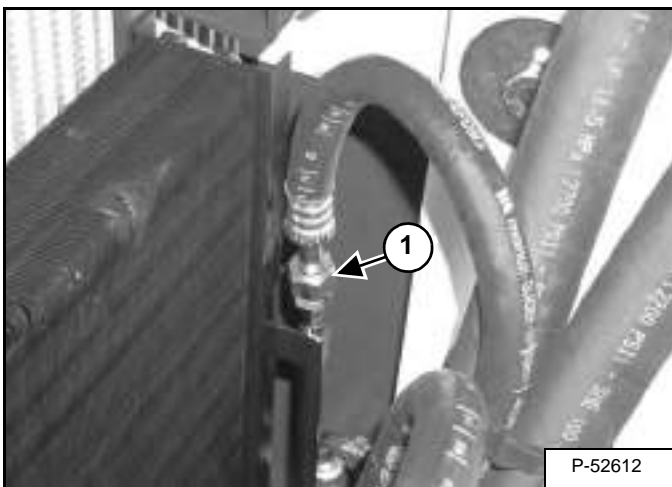

Remove the hose (Item 1) [Figure 80-120-1] from the condenser.

**NOTE:** Install caps and plugs on all fittings.

Figure 80-120-2

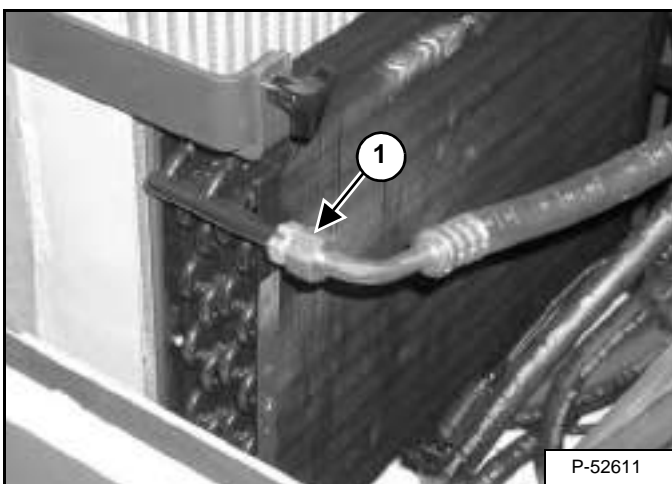

Remove the A/C hose (Item 1) [Figure 80-120-2] from the condenser.

Figure 80-120-3

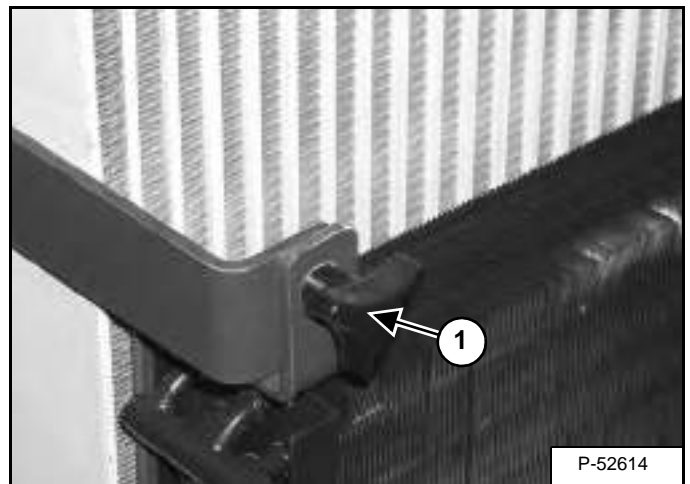

Remove the two nuts (Item 1) [Figure 80-120-3] from each side of the condenser.

Tilt the condenser forward and remove.



**Bobcat®**



## RECEIVER / DRIER

### Removal And Installation

Open the engine cover.

Remove the refrigerant from the A/C system (See "Reclamation Procedure" on page 80-100-1).

Remove the air cleaner (See "Removal And Installation" on page 60-40-1).

## WARNING

In the event of a leak, wear safety goggles. Escaping refrigerant can cause severe injuries to eyes. In contact with a flame, R134a refrigerant gives a toxic gas.

W-2371-0500

Figure 80-130-1

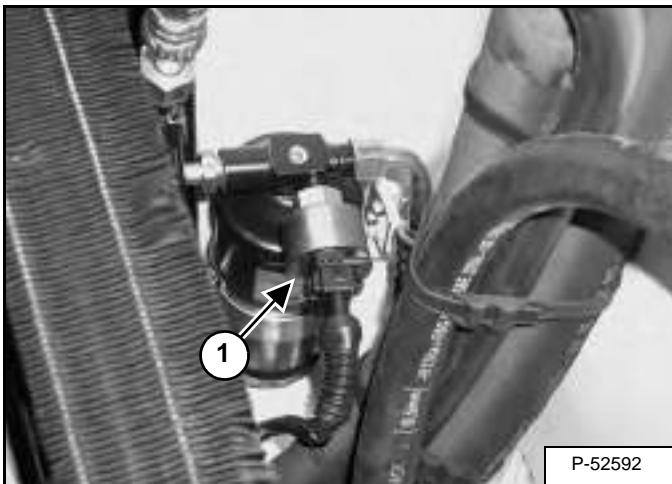

Unplug the connector (Item 1) [Figure 80-130-1] from the pressure switch.

Figure 80-130-2

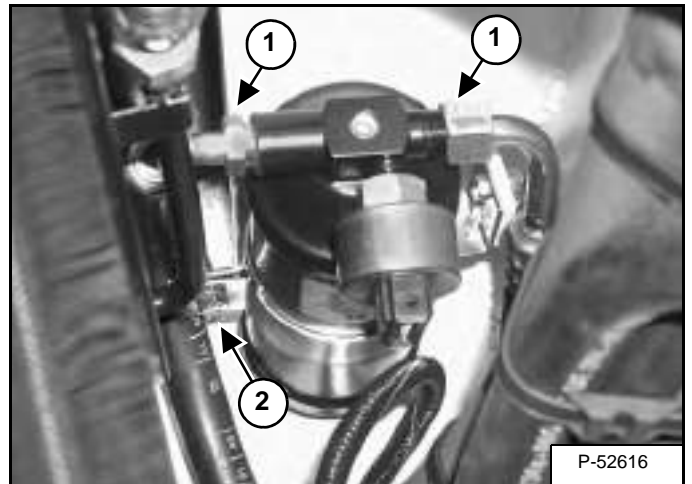

Remove the two hoses (Item 1) [Figure 80-130-2] from the Receiver / Drier.

**NOTE:** Mark the hoses for correct installation.

**NOTE:** Install caps and plugs on all fittings.

Loosen the bolt (Item 2) [Figure 80-130-2] on the mounting bracket.



**Bobcat®**

## PRESSURE SWITCH

### Removal And Installation

Open the engine cover.

Remove the refrigerant from the A/C system (See "Reclamation Procedure" on page 80-100-1).

## WARNING

In the event of a leak, wear safety goggles. Escaping refrigerant can cause severe injuries to eyes. In contact with a flame, R134a refrigerant gives a toxic gas.

W-2371-0500

Figure 80-140-1

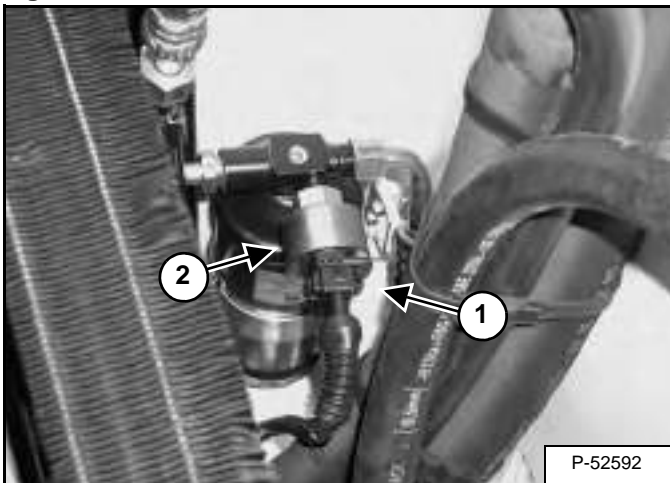

Unplug the connector (Item 1) from the pressure switch (Item 2) [Figure 80-140-1].

Figure 80-140-2

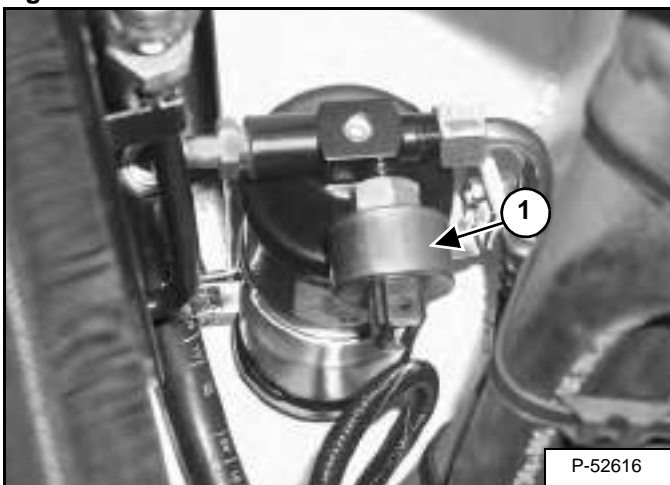

Remove the pressure switch (Item 1) [Figure 80-140-2] from the Receiver / Drier assembly.



## EVAPORATOR / BLOWER UNIT

### Removal And Installation

Remove the refrigerant from the A/C system (See "Reclamation Procedure" on page 80-100-1).

# ! WARNING

In the event of a leak, wear safety goggles. Escaping refrigerant can cause severe injuries to eyes. In contact with a flame, R134a refrigerant gives a toxic gas.

W-2371-0500

Figure 80-150-3

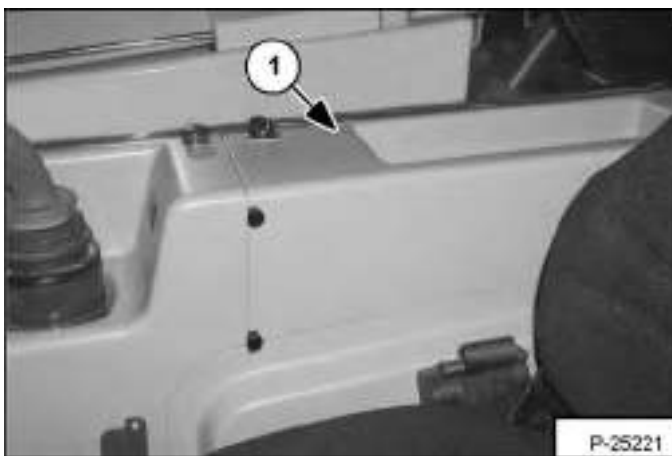

Remove the fuse box cover (Item 1) [Figure 80-150-3].

Figure 80-150-4

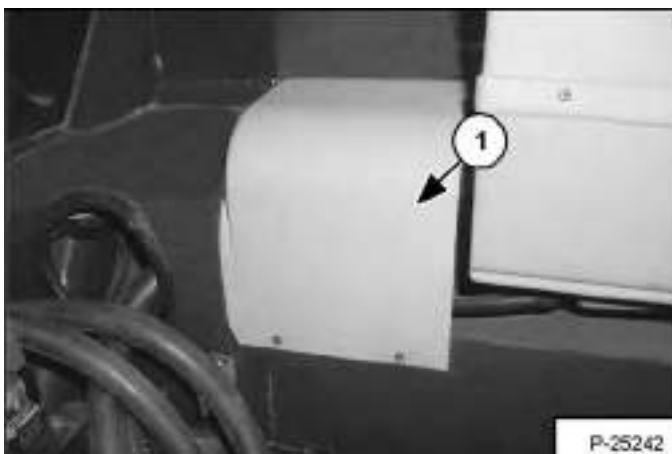

Remove the rear panel (Item 1) [Figure 80-150-4].

Figure 80-150-5

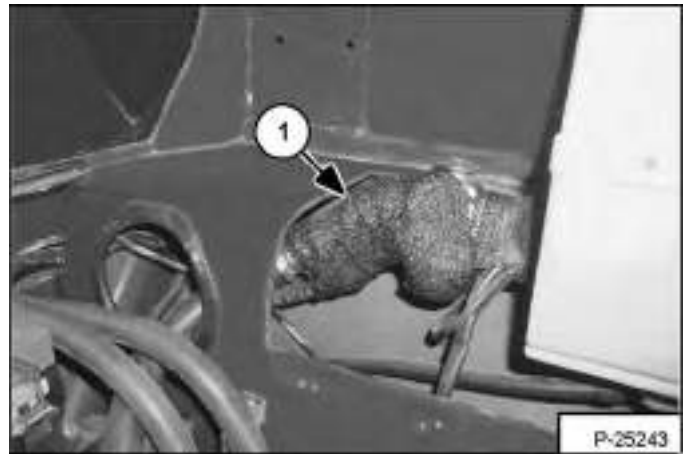

Temporarily remove the covering (Item 1) [Figure 80-150-5] from the A/C hoses and expansion valve.

Figure 80-150-6

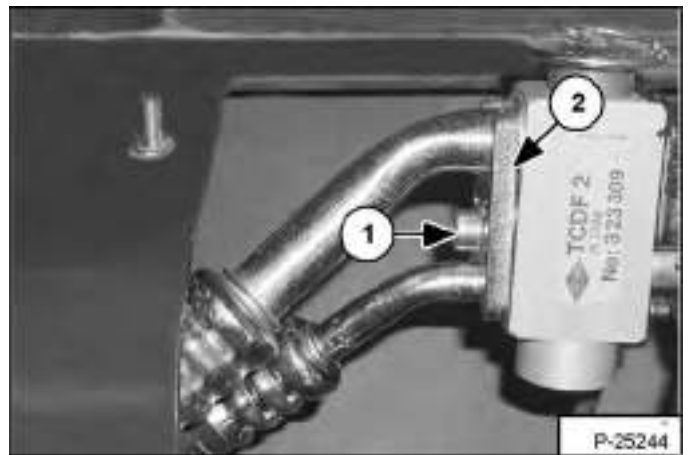

Remove the bolt (Item 1) and plate (Item 2) [Figure 80-150-6]. Remove both A/C hoses.

**NOTE:** Plug the A/C hoses to avoid contamination.

## EVAPORATOR / BLOWER UNIT (CONT'D)

### Removal And Installation (Cont'd)

Figure 80-150-7



Unplug the thermostat wiring connector (Item 1) [Figure 80-150-7].

Figure 80-150-8

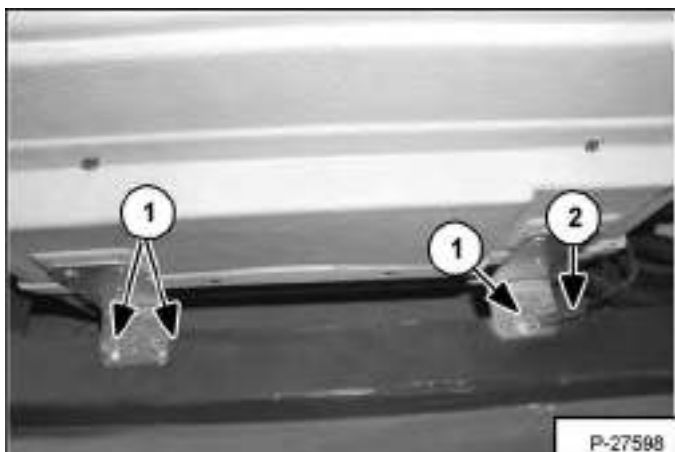

Remove the three mount bolts (Item 1) and ground wire (Item 2) [Figure 80-150-8] from the back of the evaporator unit.

Figure 80-150-9



Remove the front mounting bolt (Item 1) [Figure 80-150-9].

Lay the evaporator / blower unit on the seat.

Figure 80-150-10

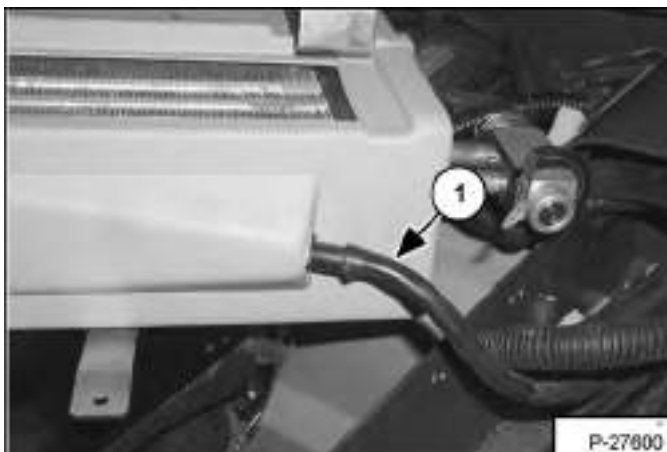

Remove the drain hose (Item 1) [Figure 80-150-10].

Remove the evaporator / blower unit from the machine.

## EXPANSION VALVE

### Removal And Installation

Remove the refrigerant from the A/C system (See "Reclamation Procedure" on page 80-100-1).

# ! WARNING

In the event of a leak, wear safety goggles. Escaping refrigerant can cause severe injuries to eyes. In contact with a flame, R134a refrigerant gives a toxic gas.

W-2371-0500

Figure 80-160-11



Remove the fuse box cover (Item 1) [Figure 80-160-11].

Figure 80-160-12

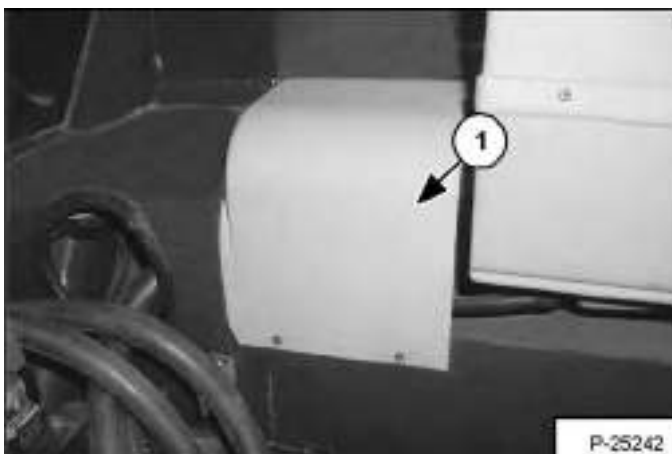

Remove the rear panel (Item 1) [Figure 80-160-12].

Figure 80-160-13

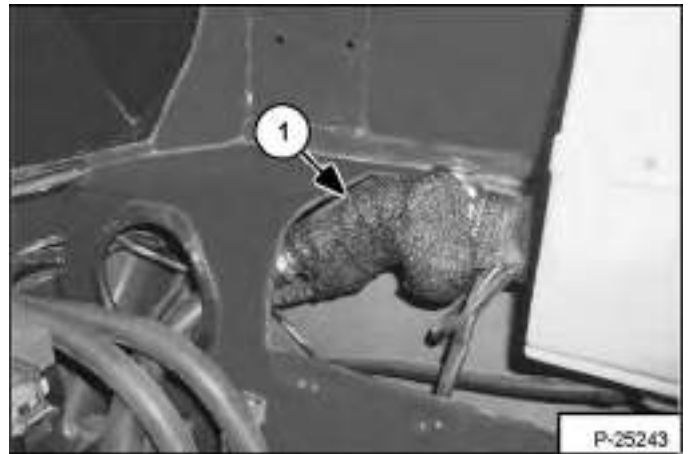

Temporarily remove the covering (Item 1) [Figure 80-160-13] from the A/C hoses and expansion valve.

Figure 80-160-14

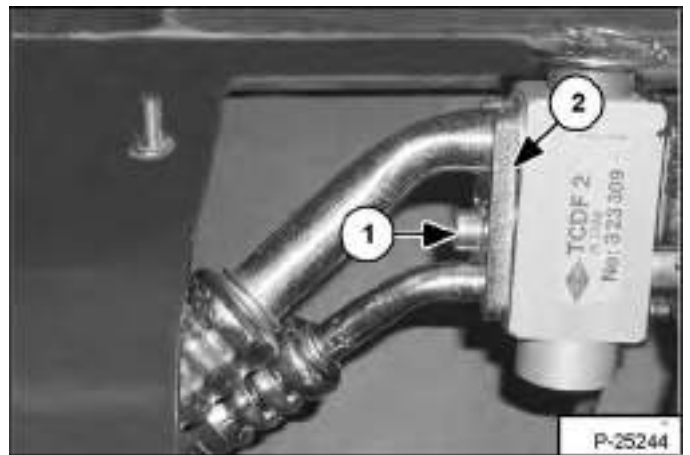

Remove the bolt (Item 1) and plate (Item 2) [Figure 80-160-14]. Remove both A/C hoses.

**NOTE:** Plug the A/C hoses to avoid contamination.

## EXPANSION VALVE (CONT'D)

### Removal And Installation (Cont'd)

Figure 80-160-15

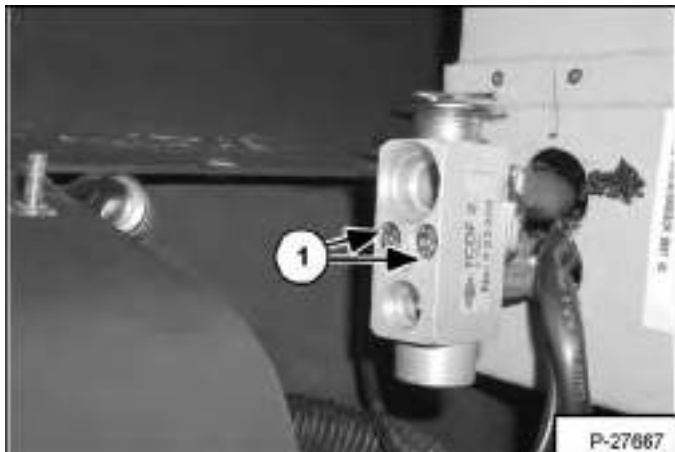

Remove the two mount bolts (Item 1) [Figure 80-160-15].

Remove the expansion valve.

Figure 80-160-16

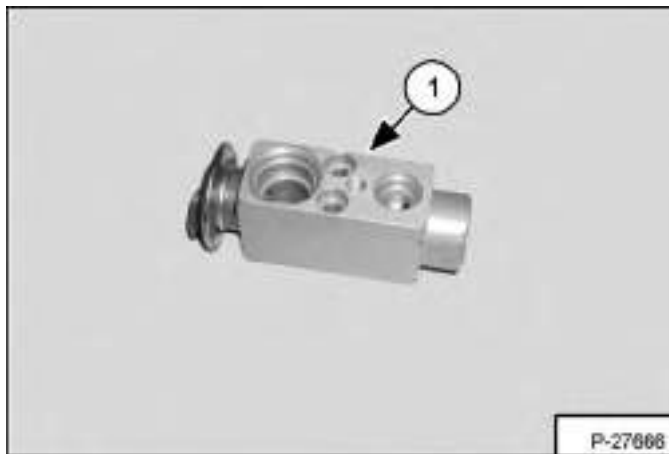

The expansion valve (Item 1) [Figure 80-160-16] is replaced as a complete unit.



## HEATER ASSEMBLY

### Removal And Installation

Remove the travel / signal levers (See "Removal And Installation" on page 60-70-1).

Remove the instrument panel (See "Removal And Installation" on page 60-80-1).

Remove the switch panel (See "Removal And Installation" on page 60-90-1).

Remove the dash cover / steering column cover (See "Removal And Installation" on page 50-130-1).

**Figure 80-170-1**

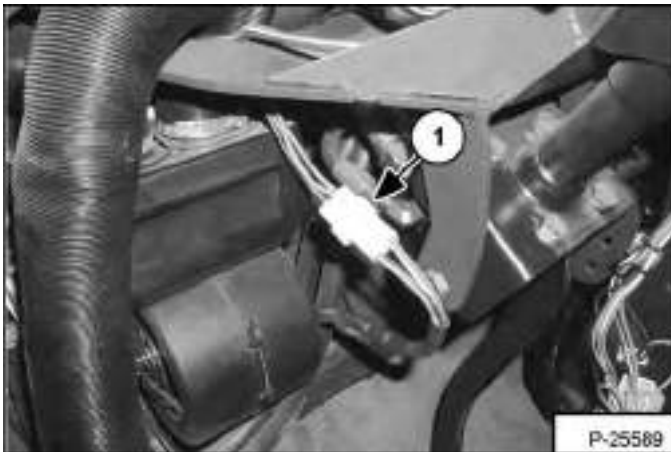

Unplug the connector (Item 1) [Figure 80-170-1].

**Figure 80-170-2**

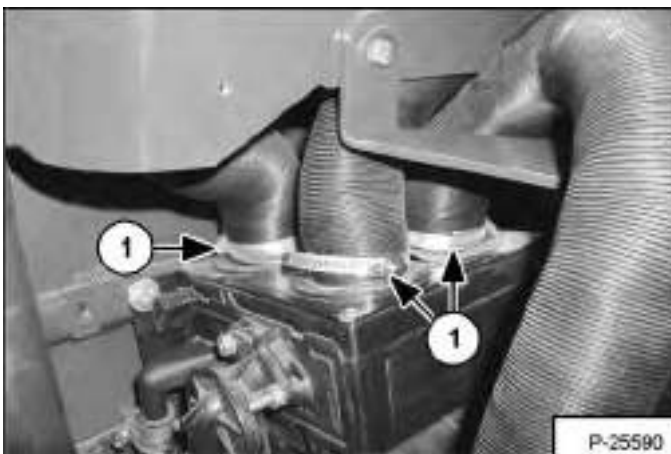

Remove the vent hoses (Item 1) [Figure 80-170-2] from the top of the assembly.

**Figure 80-170-3**



Clamp the heater hoses [Figure 80-170-3].

**Figure 80-170-4**

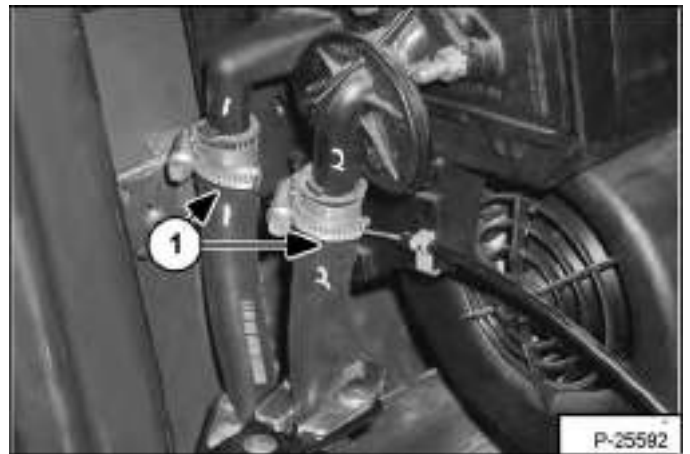

Remove the heater hoses (Item 1) [Figure 80-170-4] from the heater assembly.

**NOTE:** Mark the hoses for correct installation.

## HEATER ASSEMBLY (CONT'D)

### Removal And Installation (Cont'd)

Figure 80-170-5

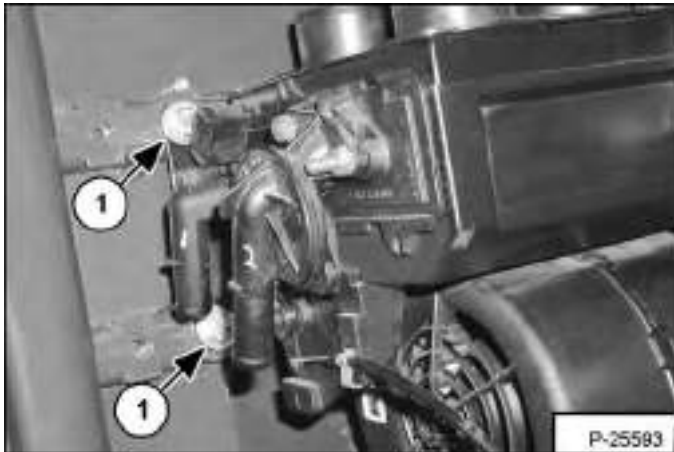

Remove the mounting bolts (Item 1) [Figure 80-170-5] and remove the heater assembly.

### Fan Removal And Installation

Figure 80-170-6

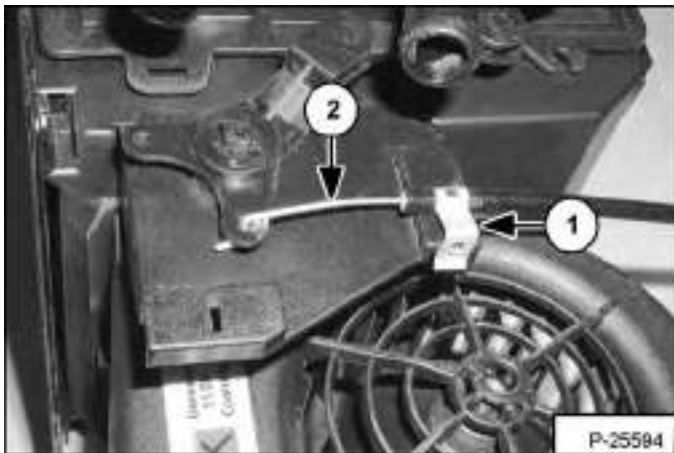

Carefully remove the clip (Item 1) and cable (Item 2) [Figure 80-170-6].

Figure 80-170-7

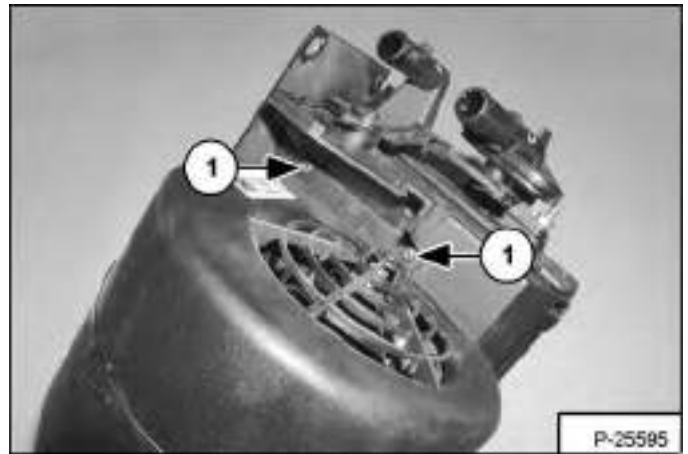

Remove the fan mounting bolts (Item 1) [Figure 80-170-7] and remove the fan.

### Core Removal And Installation

Figure 80-170-8

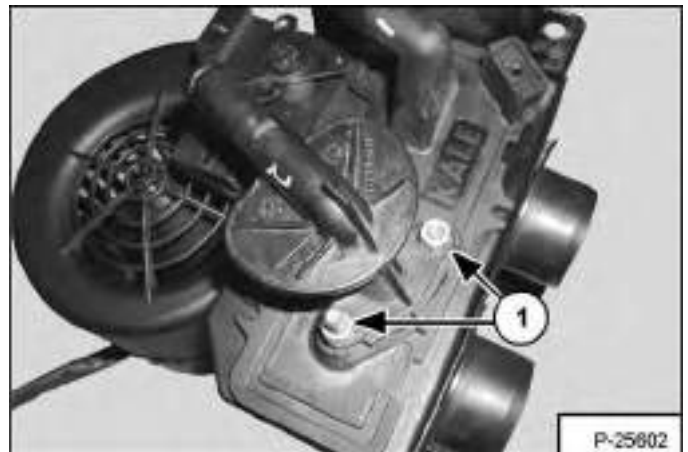

Remove the two flange mounting nuts (Item 1) [Figure 80-170-8].

## HEATER ASSEMBLY (CONT'D)

### Core Removal And Installation (Cont'd)

Figure 80-170-9

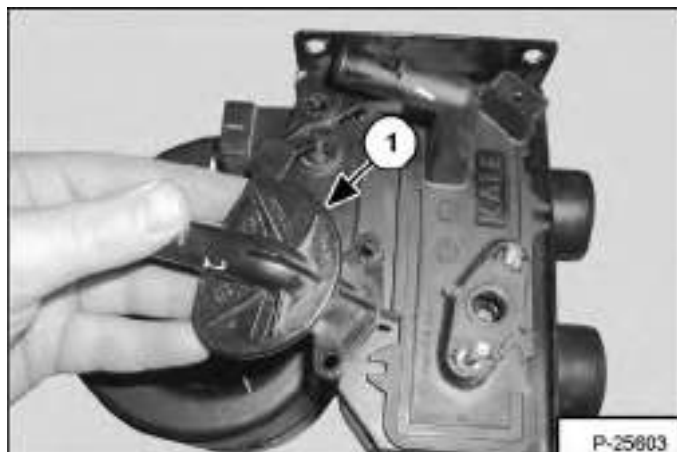

Remove the flange / linkage assembly (Item 1) [Figure 80-170-9] from assembly.

Figure 80-170-10

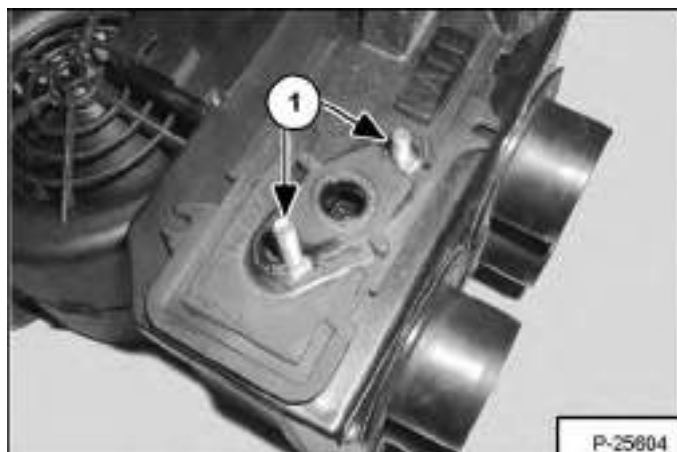

Remove the two bolts (Item 1) [Figure 80-170-10] and save for later use.

Figure 80-170-11

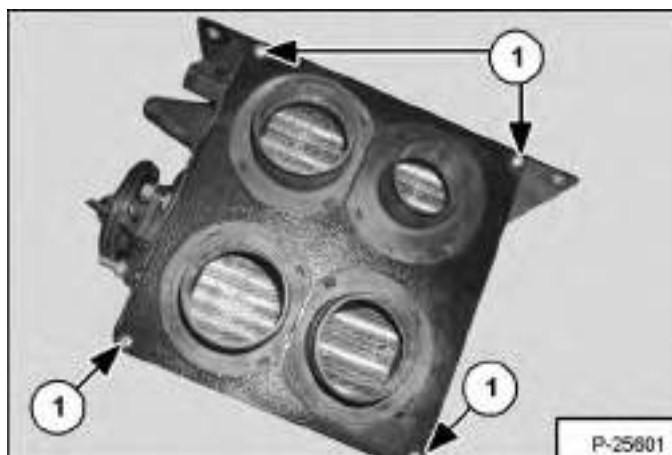

Remove the four screws (Item 1) [Figure 80-170-11] from the vent bracket.

Figure 80-170-12

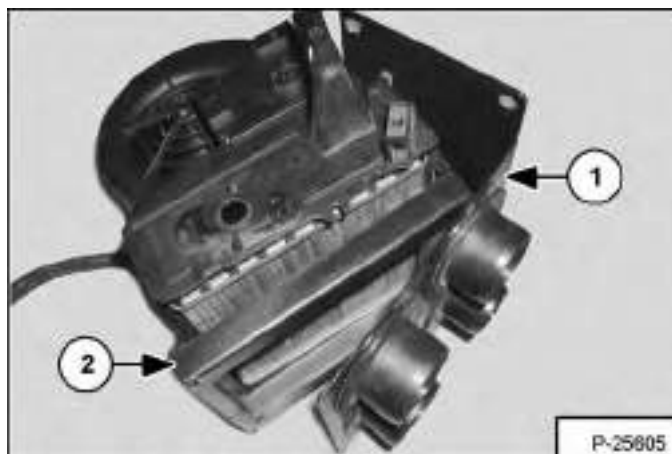

Remove the end bracket (Item 1) and spacer (Item 2) [Figure 80-170-12] from the assembly.

---

## HEATER ASSEMBLY (CONT'D)

### Core Removal And Installation (Cont'd)

Figure 80-170-13

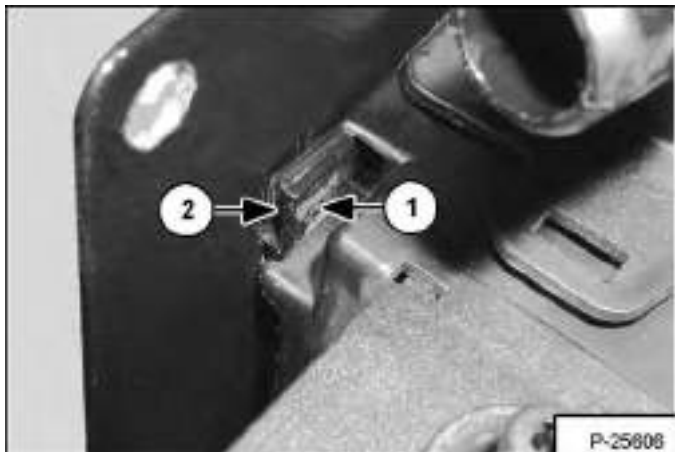

Be sure to separate the bracket (Item 1) and tab (Item 2) [Figure 80-170-13].

Figure 80-170-14



Slide the core from the housing [Figure 80-170-14].

---

## SPECIFICATIONS

CONVERSIONS . . . . .	SPEC-70-1
Decimal And Millimeter Equivalents . . . . .	SPEC-70-1
U.S. To Metric Conversion . . . . .	SPEC-70-2
ENGINE SPECIFICATIONS . . . . .	SPEC-20-1
Camshaft And Thrust Washer . . . . .	SPEC-20-6
Connecting Rods And Bearings . . . . .	SPEC-20-4
Crankshaft . . . . .	SPEC-20-4
Crankshaft Re-Grind Data . . . . .	SPEC-20-5
Cylinder Block . . . . .	SPEC-20-6
Cylinder Head . . . . .	SPEC-20-1
Cylinder Liners . . . . .	SPEC-20-7
Engine Torque Component . . . . .	SPEC-20-11
Exhaust Valves . . . . .	SPEC-20-2
Flywheel . . . . .	SPEC-20-9
Fuel Injection Pump . . . . .	SPEC-20-7
Fuel Injectors . . . . .	SPEC-20-7
Fuel Lift Pump . . . . .	SPEC-20-7
General . . . . .	SPEC-20-1
Intake Valves . . . . .	SPEC-20-2
Main Bearings . . . . .	SPEC-20-6
Oil Pump, Gear And Relief Valve . . . . .	SPEC-20-9
Pistons And Piston Rings . . . . .	SPEC-20-3
Rocker Shaft, Rockers And Bushings . . . . .	SPEC-20-3
Thrust Washers . . . . .	SPEC-20-6
Timing Case And Timing Gears . . . . .	SPEC-20-8
Turbocharger . . . . .	SPEC-20-9
Valve Guides . . . . .	SPEC-20-1
Valve Springs . . . . .	SPEC-20-2
Water Pump And Thermostat . . . . .	SPEC-20-10
HYDRAULIC CONNECTION SPECIFICATIONS . . . . .	SPEC-50-1
Flare Fitting . . . . .	SPEC-50-2
O-ring Face Seal Connection . . . . .	SPEC-50-1
O-ring Flare Fitting . . . . .	SPEC-50-3
Port Seal Fitting . . . . .	SPEC-50-5
Straight Thread O-ring Fitting . . . . .	SPEC-50-1
Tubelines And Hoses . . . . .	SPEC-50-1
HYDRAULIC / HYDROSTATIC FLUID SPECIFICATIONS . . . . .	SPEC-60-1
Specifications . . . . .	SPEC-60-1

**SPECIFICATIONS**

Continued On Next Page

---

## SPECIFICATIONS (CONT'D)

MACHINE TORQUE SPECIFICATIONS . . . . .	SPEC-30-1
Axle . . . . .	SPEC-30-1
Boom . . . . .	SPEC-30-1
Drive Box . . . . .	SPEC-30-1
Drive Motor . . . . .	SPEC-30-1
Engine . . . . .	SPEC-30-2
Hydraulic Pump . . . . .	SPEC-30-2
TORQUE SPECIFICATIONS FOR BOLTS . . . . .	SPEC-40-1
Torque For General Metric Bolts . . . . .	SPEC-40-2
Torque for General SAE Bolts . . . . .	SPEC-40-1
TELESCOPIC HANDLER SPECIFICATIONS . . . . .	SPEC-10-1
Capacities . . . . .	SPEC-10-3
Controls . . . . .	SPEC-10-2
Dimensional Specifications T40140 . . . . .	SPEC-10-1
Drive System . . . . .	SPEC-10-3
Electrical System . . . . .	SPEC-10-4
Engine . . . . .	SPEC-10-2
Hydraulic System . . . . .	SPEC-10-3
Instrument Panel . . . . .	SPEC-10-4
Performance Specifications . . . . .	SPEC-10-2
Tires . . . . .	SPEC-10-3

## TELESCOPIC HANDLER SPECIFICATIONS

### Dimensional Specifications T40140

With DUNLOP 400/80 X 24 156 B tyres and rigid pallet frame + forks.

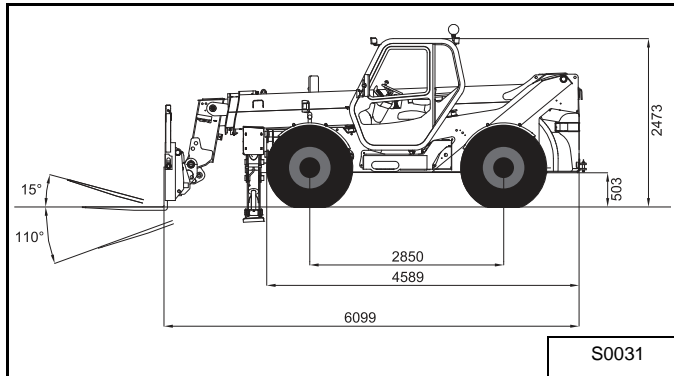

### Dimensional Specifications T40170

With DUNLOP 400/80 X 24 156 B tyres and rigid pallet frame + forks.

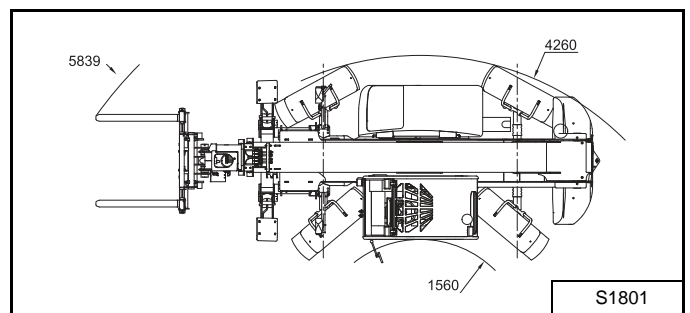
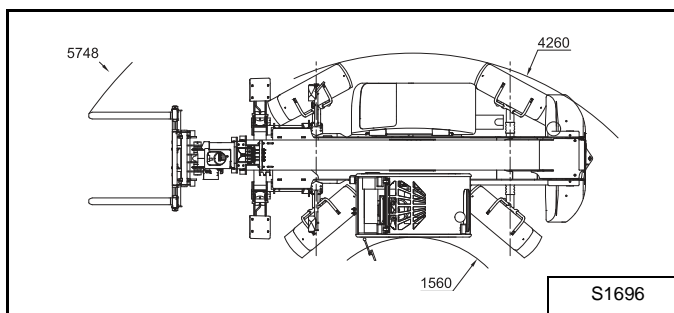
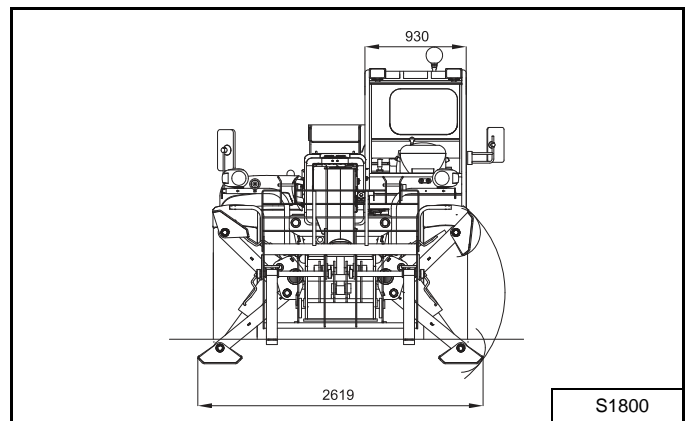
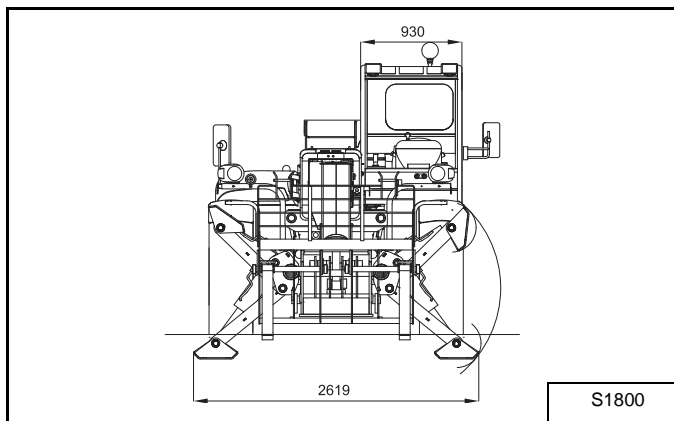
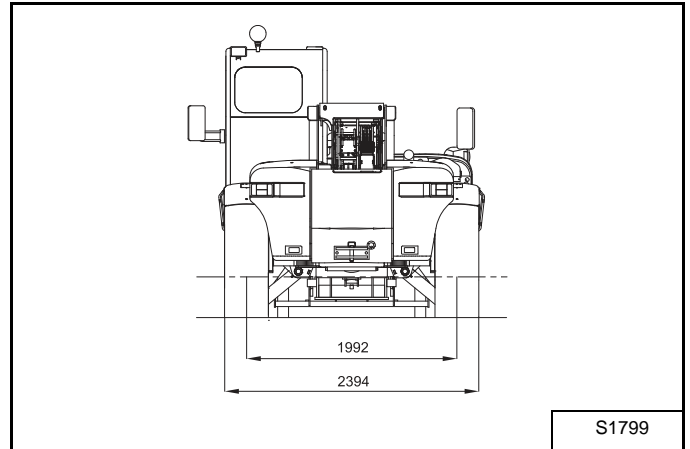
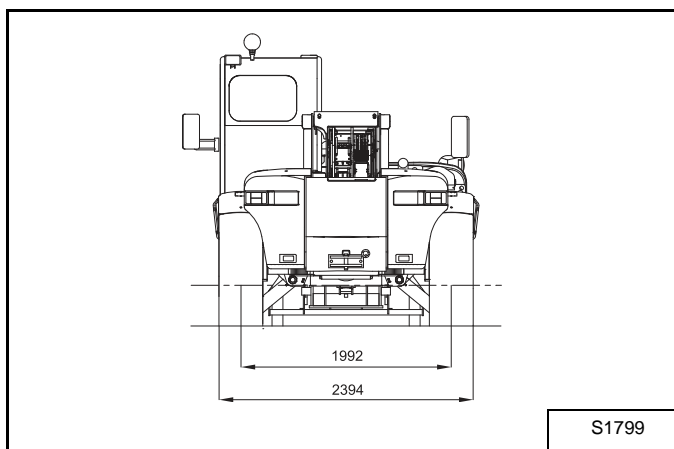
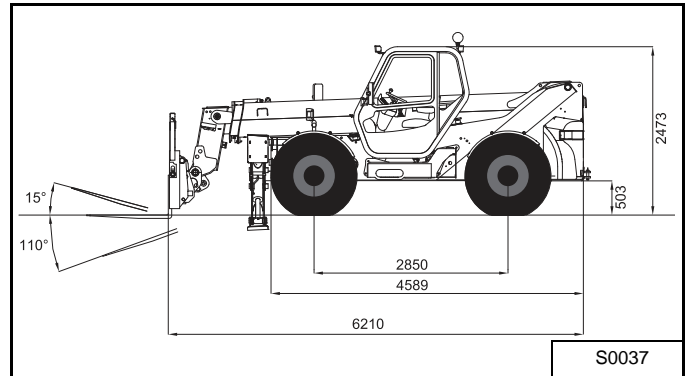

## TELESCOPIC HANDLER SPECIFICATIONS (CONT'D)

### Performance Specifications

Machine	T40140	T40170
Lifting height - on tires	13430 mm	17430 mm
Lifting height - on stabilizers	13610 mm	17180 mm
Rated capacity	4000 kg	4000 kg
Capacity (at max. height on stabilizers)	4000 kg	2500 kg
Capacity (at max. height on tires)	2500 kg	1250 kg
Capacity (at max. reach on stabilizers)	1300 kg	560 kg
Capacity (at max. reach on tires)	250 kg	0 kg
Max. reach on tires	9800 mm	13730 mm
Max. reach on stabilizers	9700 mm	13670 mm
Telescope fully retracted - on tires		3160 mm
Telescope fully retracted - on stabilizers		2220 mm
Crowding force	5000 daN	5000 daN

	Weight (kg)					
	T40140			T40170		
	Total	On front axle	On rear axle	Total	On front axle	On rear axle
With no attachment	10000	3790	6210	10790	4720	6250
With pallet frame and forks - 4000 kg load	14320	12235	2085	15290	13395	1895
With pallet frame and forks - no load	10320	4370	5950	11290	5325	5965

### Engine

Make / Model	PERKINS 1104C-44T (Turbo)
Fuel / Cooling	Diesel / Liquid
Horsepower (SAE Net)	100 HP (74,5 kW)
Number of Cylinders	Four
Lubrication	Pressure System W / Filter
Air Cleaner	Dry replaceable cartridge w / safety element

### Controls

Steering	Steering Wheel w / 3 Mode Selections (Front-Wheel, All-Wheel, Crab)
Hydraulics	Joystick (electric) w / switches
Auxiliary Hydraulics	Electric Switches on Joystick
Parking Brake	Hand Operated Lever



## TELESCOPIC HANDLER SPECIFICATIONS (CONT'D)

### Drive System

Main Drive	Hydrostatic 4 wheel drive
Transmission	Infinitely variable hydrostatic piston pump, driving 1 fully reversing hydrostatic motor
Final Drive	Front Differential with reduction gear box, Rear Differential, Planetary Axles with Oil Lubrication.

Travel Speed	
Low Range	0-8 km/h
High Range	0-30 km/h

### Tires

	T40140	T40170
Standard Tires	4 DUNLOP 400/80x24 156B tires with 4,25-bar pressure	4 DUNLOP 400/80x24 156B tires with 4,75-bar pressure

### Capacities

	T40140	T40170	Type
Fuel Tank	140 L	140L	Diesel #2 or #1
Hyd. / Hydros. System (complete circuit)	145 L	145L	EQUIVIS ZS 46
Hyd. / Hydros. System (tank only)	77 L	77 L	EQUIVIS ZS 46
Eng. Cooling System	17 L	17 L	Antifreeze mixture (Ethylene Glycol)
Lubrication circuit	8,5 L	8,5 L	See oil chart
Front Axle (central casing)	6,7 L	6,7 L	100032-06A
Rear Axle (central casing)	6,6 L	6,6 L	100032-06A
Front Reduction Gearbox	0,8 L	0,8 L	100032-06A
Front axle transferbox	0,8 L	0,8 L	100032-06A
Rear planetary carrier	0,8 L	0,8 L	100032-06A

### Hydraulic System

Hydraulic Pump	Engine driven, 25 GPM (95 L/min)
Hydraulic Pressure	3843 PSI (265 Bar)
Auxiliary Flow	@ High idle 0-21 GPM (0-80 L/min)

---

**TELESCOPIC HANDLER SPECIFICATIONS (CONT'D)****Electrical System**

Alternator	14,2 Volt, 70 A with internal regulator
Battery	12 V — 105 Ah — 720A
Starter	12 V and 2,8 kW
Circuit breaker	
Centralized fuse, relay and diode box	
Hydrostatic transmission control electronic box	
Stabilizer, CDDL and AMA control electronic box	

**Instrument Panel**

Full compliment of instrumentation for engine, hydraulic and machine functions.
---

## ENGINE SPECIFICATIONS

*All dimensions are given in inches. Respective metric dimensions are given in millimeters enclosed by parentheses.*

### General

Number Of Cylinders	4
Cylinder Arrangement	In-line
Cycle	4 Stroke
Direction Of Rotation	Clockwise From The Front
Intake System	Turbocharged
Combustion System	Direct Injection
Nominal Bore	3.937 (100)
Stroke	4.134 (105)
Compression Ratio	17.25:1
Displacement	243 C.I. (4 liters)
Firing Order	1-3-4-2

### Cylinder Head

Head Thickness	4.643 - 4.647 (117,95 - 118,05)
Head Thickness After Machining (Minimum)	4.614 (117,20)
Valve Seat Angle	30°
Leak Test Pressure	29 PSI (2 Bar)

### Valve Guides

Inside Diameter	0.3248-0.3287 (8,250-8,350)
Outside Diameter	0.5131-0.5137 (13,034-13,047)
Valve Guide Bore	0.5118-0.5129 (13,000-13,027)
Valve Guide Clearance In The Cylinder Head (Interference)	0.0003-0.00019 (0,007-0,047)
Overall Length:	
Intake	5.076-5.093 (128,92-129,37)
Exhaust	5.075-5.093 (128,92-129,37)
Protrusion From Bottom	0.486-0.498 (12,35-12,65)

## ENGINE SPECIFICATIONS (CONT'D)

*All dimensions are given in inches. Respective metric dimensions are given in millimeters enclosed by parentheses.*

### Exhaust Valves

Valve Stem Diameter	0.3515-0.3 528(8,93-8,96)
Valve Guide Clearance	0.0016-0.0033 (0,040-0,84)
Maximum	0.006 (0,15)
Valve Head Diameter	1.634-1.644 (41,51-41,75)
Valve Face Angle	30°
Overall Length	5.075-5.093 (128,92-129,37)
Seal Type	Stem seal with integral seating washer
Valve Seat Angle	30°
Valve Clearance	0.018 (0,45)
Exhaust Depth (Production)	0.060-0.071 (1,53-1,81)
Exhaust Depth (Service)	0.081 (2,06)

### Intake Valves

Valve Stem Diameter	0.3525-0.3535 (8,95-8,98)
Valve Guide Clearance	0.0010-0.0027 (0,025-0,069)
Maximum	0.005 (0,13)
Valve Head Diameter	1.819-1.829 (46,20-46,45)
Valve Face Angle	30°
Overall Length	5.076-5.093 (128,92-129,37)
Seal Type	Stem seal with integral seating washer
Valve Seat Angle	30°
Valve Clearance	0.008 (0,20)
Intake Depth (Production)	0.062-0.072 (1,58-1,84)
Intake Depth (Service)	0.082 (2,09)

### Valve Springs

Installed Height	1.358 (34,5)
Installed Height Pressure	51 lb. (229 N)
Number Of Active Coils	3.8

## ENGINE SPECIFICATIONS (CONT'D)

*All dimensions are given in inches. Respective metric dimensions are given in millimeters enclosed by parentheses.*

### Rocker Shaft, Rockers And Bushings

Shaft Outside Diameter	0.9828-0.9837(24,962-24,987)
Clearance Between Rocker Arm Bushing and Shaft	0.0010-0.0035 (0,26-0,89)
Maximum	0.007 (0,17)

### Pistons And Piston Rings

Type	Fastram combustion bowl inserted top ring groove, graphite skirt
Piston Pin Bore Diameter	1.5631-1.5633 (39,703-39,709)
Piston Projection Above the Block Deck	0.008-0.0137 (0,21-0,35)
Top Ring Groove Width	Tapered
Second Ring Groove Width	0.0999-0.1007 (2,54-2,56)
Third Ring Groove Width	0.1385-0.1393 (3,52-3,54)
Top Ring	Barrel Face, Molybdenum insert, Keystone
Second Ring	Taper Face, Cast Iron, Internal Bottom Step
Oil Control Ring	Two Piece Coil Spring Loaded, Chromium Face
Top Ring Width	Tapered
Second Ring Width	0.097-0.098 (2,48-2,49)
Third Ring Width	0.1366-0.1374 (3,47-3,49)
Top Ring Side Clearance	Wedge
Second Ring Side Clearance	0.002-0.003 (0,05-0,09)
Third Ring Side Clearance	0.0011-0.0027 (0,03-0,07)
Top Ring End Gap	0.011-0.021 (0,30-0,55)
Second Ring End Gap	0.027-0.037 (0,70-0,95)
Third Ring End Gap	0.0118-0.0216 (0,30-0,55)
Piston Pin Type	Full Floating
Piston Pin Outside Diameter	1.5628-1.5630 (39,694-39,700)
Piston Boss Clearance	0.0001-0.0006 (0,003-0,015)
Bushing Type	Steel Back, Lead Bronze Tin Bearing Material
Bushing Outside Diameter	1.7190-1.7259 (43,66-43,84)
Bushing Inside Diameter (Reamed)	1.5638-1.5645 (39,723-39,738)
Piston Pin Bushing Clearance	0.0009-0.0017 (0,023-0,044)

## ENGINE SPECIFICATIONS (CONT'D)

*All dimensions are given in inches. Respective metric dimensions are given in millimeters enclosed by parentheses.*

### Connecting Rods And Bearings

Connecting Rod Type	H Section, Wedge Shape Small End
Connecting Rod Cap Location	Flat joint face with dowels
Crank Pin End Diameter	2.6460-2.6465 (67,21-67,22)
Piston Pin End	1.693-1.694 (43,01-43,03)
Length Between Centers	8.624-8.626 (219,05-219,10)
Bearing Type	Steel Back, Lead Bronze Bearing Material with Lead Finish
Bearing Width	1.240-1.255 (31,55-31,88)
Bearing Thickness At The Center	0.0723-0.0725 (1,835-1,842)
Bearing Clearance	0.0012-0.0032 (0,03-0,081)
Bearing Undersize Available	-0.010 (-0,25), -0.020 (-0,50), -0.030 (-0,75)

### Crankshaft

Main Journals	2.998-2.999 (76,16-76,18)
Maximum Wear And Out Of Round Of The Journals And Crank Pins	0.0016 (0,04)
Width Of Center Journal	1.738-1.741 (44,15-44,22)
Width Of Other Journals	1.545-1.549 (39,24-39,34)
Crank Pin Diameters	2.499-2.500 (63,47-63,49)
Width Of Crank Pins	1.589-1.591 (40,35-40,42)
Crankshaft End Play	0.0002-0.015 (0,05-0,38)
Thrust Washer Thickness: Std.	0.089-0.091 (2,26-2,31)
Oversize	0.096-0.098 (2,45-2,50)
Main Bearing Oil Clearance	0.0022-0.0046 (0,057-0,117)

## ENGINE SPECIFICATIONS (CONT'D)

All dimensions are given in inches. Respective metric dimensions are given in millimeters enclosed by parentheses.

### Crankshaft (Cont'd)

Undersize Journals And Crank Pins	0.010 (0,25), 0.020 (0,50), 0.030 (0,75)
-----------------------------------	--

With the crankshaft on V-blocks check the maximum run-out of the journals. They must not exceed these specifications below and the difference in run-out between journals must not exceed 0.004 (0,10)

Journal #1	Mounting
Journal #2	0.003 (0,08)
Journal #3	0.006 (0,15)
Journal #4	0.003 (0,08)
Journal #5	Mounting

### Crankshaft Re-Grind Data

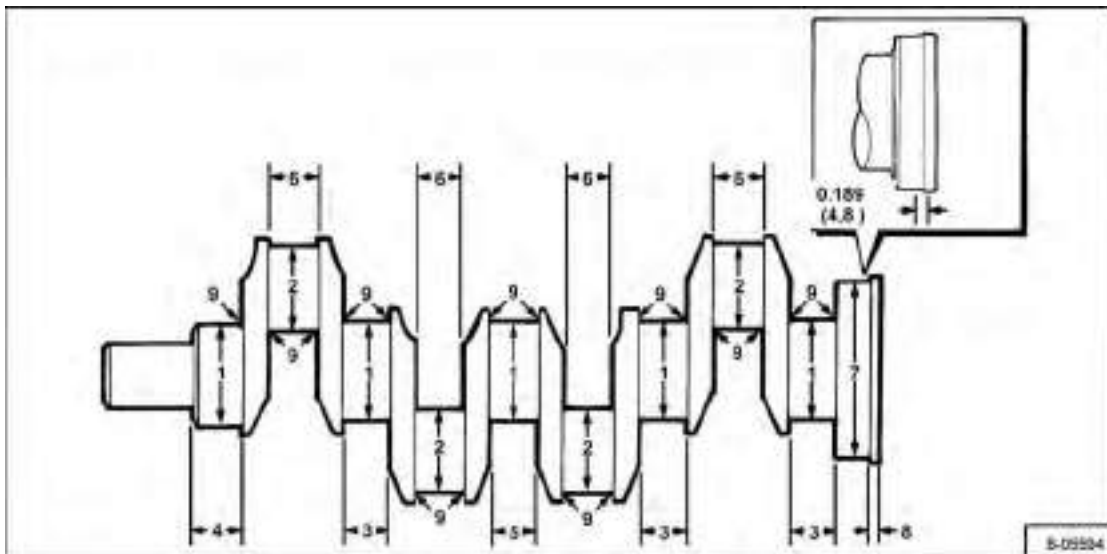

The finished sizes for crankshaft journals which have been ground undersize are given in the table below:

ITEM	0.010 (0,25)	0.020 (0,51)	0.030 (0,76)
1	2.9884-2.9892 (75.909-75.930)	2.9784-2.96792 (75,649-75,670)	2.9684-2.9692 (75,399-75,420)
2	2.488-2.4896 (63,220-63,240)	2.4788-2.4796 (62,962-62,982)	2.4688-2.4696 (62,708-62,728)
3	1.554 (39,47) maximum	-	-
4	1.474 (37,44) maximum	-	-
5	1.759 (44,68) maximum	-	-
6	1.596 (40,55) maximum	-	-
7	Do not machine this diameter	-	-
8	Do not machine this diameter	-	-
9	0.1448-0.1452 (3,68-3,69)	-	-

Crankshaft Heat Treatment: 60 Hour Nitride

**NOTE: Crankshafts that have been nitrided for 60 hours can be machined 0.010 (0,25) without the need to harden again. Check the crankshaft for cracks before and after machining. Demagnetize the crankshaft after it has been checked for cracks. Remove any sharp corners from the oil holes. Surface finish and fillet radii must be maintained.**

## ENGINE SPECIFICATIONS (CONT'D)

*All dimensions are given in inches. Respective metric dimensions are given in millimeters enclosed by parentheses.*

### Main Bearings

Type	Steel Back, 20% Tin Aluminium
All Others	1.244-1.255 (31,62-31,88)
Bearing Thickness (center)	0.0820-0.0823 (2,083-2,089)
Bearing Clearance	0.0022-0.0046 (0,057-0,117)
Bearing Undersize Available	-0.010 (-0,25) -0.020 (-0,50) -0.030 (-0,75)

### Thrust Washers

Type	Steel back, bearing material
Position	Each Side Of Center Main Bearing
Standard	0.089-0.091 (2,26-2,31)
Oversize	0.096-0.098 (2,45-2,50)

### Camshaft And Thrust Washer

Journal #1 Diameter	1.997-1.998 (50,71-50,74)
Journal #2 Diameter	1.987-1.988 (50,46-50,48)
Journal #3 Diameter	1.967-1.968 (49,95-49,98)
Cam Lift (Intake)	0.2768-0.2807 (7,03-7,13)
Cam Lift (Exhaust)	0.3135-0.3174 (7,963-8,063)
Maximum Wear And Out Of Round	0.021 (0,05)
Camshaft End Play (Production)	0.004-0.022 (0,10-0,55)
Service Limits	0.023 (0,60)
Thrust Washer Type	360°
Thrust Washer Thickness	0.216-0.218 (5,49-5,54)
Thrust Washer Recess Depth	0.218-0.222 (5,54-5,64)

### Cylinder Block

Cylinder Bore Diameter	4.1338-4.1348 (105,000-105,025)
Main Bearing Bore Diameter	3.166-3.167 (80,416-80,442)



## ENGINE SPECIFICATIONS (CONT'D)

*All dimensions are given in inches. Respective metric dimensions are given in millimeters enclosed by parentheses.*

### Cylinder Liners

Production	Dry, Interference Fit, Flanged, With Flame Ring
Service	Dry, Interference Fit, Flanged, With Flame Ring
Production Liner Outside Diameter	4.105-4.106 (104,25-104,28)
Production Liner Clearance	0.001-0.003 (0,03-0,08)
Production Liner Inside Diameter	3.937-3.938 (100,00-100,03)
Service Liner Clearance	±0.001 (±0,03)
Inside Diameter Of Service Liner With Flame Ring (Installed)	3.937-3.961 (100,0-100,63)
Maximum	0.010 (0,25)
Flange Thickness	0.150-0.152 (3,81-3,86)
Liner Projection From Deck Surface	0.004 (0,10) Above or 0.004 (0,10) Below
Hose Angle	30/35°
Piston Cooling Jets	7 ft.lbs. (9 N•m)

### Fuel Injection Pump

Type	DELPHI DP 210 with locking screw
Rotation From Drive End	Clockwise
Fuel System	Self Vent

### Fuel Injectors

Working Pressure	4263 PSI (294 Bar)
------------------	--------------------

### Fuel Lift Pump

Type	Electrically operated
Method of Drive	Electric Motor 12V/24V
Standard Pressure	6-10 PSI (0,41-0,69 Bar)
Minimum Pressure	3.75 PSI (0,26 Bar)

---

## ENGINE SPECIFICATIONS (CONT'D)

*All dimensions are given in inches. Respective metric dimensions are given in millimeters enclosed by parentheses.*

### Timing Case And Timing Gears

Camshaft Gear Number Of Teeth	68
Camshaft Gear Bore Diameter	1.375-1.376 (34,93-34,95)
Camshaft Hub Outside Diameter	1.374-1.375 (34,90-34,92)
Fuel Pump Gear Number Of Teeth (Electronic)	68
Fuel Pump Gear Bore (Electronic)	1.417-1.419 (29,99-30,02)
Crankshaft Gear Number Of Teeth	34
Crankshaft Gear Bore Diameter	1.875-1.8760 (47,625-47,650)
Crankshaft Gear Hub Diameter	1.875-1.8758 (47,625-47,645)
Crankshaft Gear Clearance	-0.0008 - +0.0008 (-0,020 - +0,020)
Idler Gear Number Of Teeth	73
Idler Gear Bore Diameter	2.250-2.251 (57,14-57,18)
(With Needle Bearings)	2.848-2.849 (72,35-72,36)
Width Of Idler Gear And Bushing Assembly (Fitted)	1.186-1.187 (30,14-30,16)
Flanged Bushing Inside Assembly (Fitted)	1.999-2.000 (50,78-50,80)
Idler Gear Hub Outside Diameter	1.9990-1.9999 (50,70-50,74)
(With Needle Bearings)	1.967-1.968 (49,975-49,988)
Idler Gear Hub Bushing Clearance	0.0016-0.0039 (0,04-0,10)
Gear End Play (Production Limits)	0.004-0.008 (0,10-0,20)
(With Needle Bearings)	0.0039-0.0295 (0,10-0,75)
Service Limit	0.015 (0,38)
Backlash For All Gears	0.003 (0,08) Minimum

## ENGINE SPECIFICATIONS (CONT'D)

*All dimensions are given in inches. Respective metric dimensions are given in millimeters enclosed by parentheses.*

### Oil Pump, Gear And Relief Valve

Type of Oil Pump	Gear Driven, Differential Rotor
Number Of Lobes	Inner 5, Outer 6
Clearance Of Outer Rotor To Body	0.006-0.013 (0,15-0,34)
End Play	
Inner Rotor	0.001-0.004 (0,04-0,09)
Outer Rotor	0.0010-0.0029 (0,025-0,076)
Oil Pump Idler Gear Bushing I.D.	0.6303-0.6314 (16,012-16,038)
Idler Shaft O.D.	0.6285-0.5292 (15,966-15,984)
Idler Gear Shaft Bushing Clearance	0.0011-0.0028 (0,028-0,072)
Oil Pump Idler Gear End Play	0.0019-0.0108 (0,050-0,275)
Relief Valve Plunger Bore Diameter	0.7578-0.7598 (19,250-19,300)
Relief Valve Plunger Outside Diameter	0.7553-0.7563 (19,186-19,211)
Clearance	0.0015-0.0044 (0,039-0,114)
Length Of The Spring (Installed)	2.35 (59,8)
Load On The Spring (Installed)	3.6-5.2 PSI (0,25 -0,36 Bar)
Pressure To Open Pressure Relief Valve	60-68 PSI (4,14-4,69 Bar)
Oil Filter Type	Full Flow Screw-on Type Canister
Pressure To Open By-pass Valve In Oil Filter	8-12 PSI (0,55-0,83 Bar)

### Turbocharger

Type	Garrett GT25
------	--------------

### Flywheel

Run-Out	Less than 0.012 (0,30)
Misalignment	0.001 (0,03) @ 1.0 (25)

---

**ENGINE SPECIFICATIONS (CONT'D)**

*All dimensions are given in inches. Respective metric dimensions are given in millimeters enclosed by parentheses.*

**Water Pump And Thermostat**

Type	Centrifugal, Gear Drive
Shaft Outside Diameter	0.8435-0.8440 (21,425-21,438)
Drive Gear Bore Diameter	0.8415-0.8425 (21,375-21,400)
Drive Gear Shaft Clearance	0.0009-0.0024 (0,025-0,063)
Impeller Bore Diameter	0.4701-0.4712 (11,943-11,971)
Impeller Shaft Outside Diameter	0.4723-0.4727 (11,997-12,008)
Impeller Clearance On Shaft	0.0010-0.0025 (0,026-0,065)
Bearing Bore Diameter	1.5743-1.5753 (39,989-40,014)
Bearing Diameter	1.5743-1.5747 (39,989-40,000)
Bearing Clearance In Pump Body	+0.0009/-0.0005 (+0,025/-0,011)
Thermostat Type	Wax Pellet, By-pass Blanking

<b>NOMINAL TEMPERATURE STAMPED ON THERMOSTAT BY-PASS VALVE</b>	<b>START TO OPEN TEMPERATURE</b>	<b>FULLY OPEN TEMPERATURE</b>	<b>MINIMUM VALVE LIFT, FULLY OPEN</b>
180° F (82° C)	170°/185° F (77°/85° C)	198°/208° F (92°/98° C)	0.35 (9,0)

**ENGINE SPECIFICATIONS (CONT'D)****Engine Torque Component**

<b>COMPONENT</b>	<b>FT.-LB.</b>	<b>N•M</b>
Bridge Piece To Block	12	16
Camshaft Gear Bolt	70	95
Connecting Rod Nuts		
Step 1	13	18
Final	52	70
Crank Pulley Bolts	85	115
Cylinder Head Bolt		
Step One	37	50
Step 2	74	100
Step Three	225°	
Step Three - Long Bolts	270°	
Engine Mounting Bridge To Frame	200	271
Exhaust Manifold Bolts	24	33
Flywheel Cover To Housing	45	61
Flywheel Housing To Cylinder Block	52	70
Flywheel To Crankshaft Bolts	77	105
Fuel Injector Nut	22	30
Fuel Injection Pump Gear Nut	18	24
Fuel Injection Pump Flange Nuts	18	24
Fuel Lift Pump Bolts	16	22
High Pressure Fuel Lines Fittings	22	30
Idler Gear Hub Bolts	33	44
Main Bearing Bolts		
Step 1	65	88
Step 2	125	170
Step 3	185	250
Oil Pan Bolts	16	22
Oil Pan Plug	25	34
Oil Pump Cover	16	22
Oil Pump To Front Main Cap	16	22
Oil Transfer Plate Bolts	22	30
Piston Cooling Jets	7	9
Rear Oil Seal Housing Bolts	16	22
Rocker Cover Nuts (With Shim Washer)	7	9
Rocker Shaft Bracket Nuts	20	27
Timing Case To Block	16	22
Timing Case Cover To Timing Case Bolts	16	22
Turbocharger To Manifold Nuts	33	44
Water Pump To Timing Case Bolts & Nuts	16	22



**Bobcat®**

## MACHINE TORQUE SPECIFICATIONS

### Axle

	FT.-LB.	N•M
Axle To Frame Mounting Bolts	275-300	370-410
Brake Housing Hex Bolt	59	80
Brake Housing Spring Bolts	7	10
Brake Housing Stud	88	120
Differential Lock Retainer Bolt	10	13
Fender Mount Bolt	90-100	125-140
Housing Bolt	236	320
Housing Nut	140	190
King Pin Mount Bolts	140	190
Pinion Ring Gear Bolts	10	13
Planetary Cover Bolts	18	25
Planetary Gear Mount Bolts	88	120
Steering Cylinder Bolts	88	120
Tie Rod Jam Nut	185	250
Tie Rod Nut	160	220
Tie Rod Swivel End	300	406
Turn Stop Adjust Jam Nut	110	150
Wheel Nuts	221	300

### Boom

	FT.-LB.	N•m
Extension Cylinder Base End	133	180
Extension Cylinder Rod End	188-210	255-285
Wear Pads Front	43	58
Wear Pads Rear	29	39

### Drive Box

	FT.-LB.	N•m
Cover Bolts	44	60
Inner Housing Bolts	88	120
Mounting Flange Bolts	44	60

### Drive Motor

	FT.-LB.	N•m
End Cap Bolts	85	115
Mounting Bolts	155	210
Mounting Plate Bolts	46	63

---

**MACHINE TORQUE SPECIFICATIONS (CONT'D)****Engine**

	<b>FT.-LB.</b>	<b>N•m</b>
A/C Compressor Mount Bolts	88	120
Alternator Mount Bolts	45	54
Starter Mount Bolts	45	54

**Hydraulic Pump**

	<b>FT.-LB.</b>	<b>N•M</b>
Filter Head	90	122
Flange Adapter	90	122
Guide Post Bolts	17	23
Mounting Bolts	78	106
Retaining Plate	10	13
Servo End Cap	10	13
Side Cover Bolts	24	32



---

## TORQUE SPECIFICATIONS FOR BOLTS

### Torque for General SAE Bolts

The following table shows standard torque specifications for bolts with zinc phosphate coating. Bolts purchased from Bobcat that have zinc phosphate coating are specified by the letter H following the part number.

THREAD SIZE		SAE GRADE 5	SAE GRADE 8
INCH. LBS.(N•m)	.250	80-90 (9,0-10,2)	110-120 (12,4-13,6)
	.3125	180-200 (20,3-22,6)	215-240 (24,2-27,1)
FOOT LBS.(N•m)	.375	25-28 (34-38)	35-40 (47-54)
	.4375	40-45 (54-61)	60-65 (81-88)
	.500	65-70 (88-95)	90-100 (122-136)
	.5625	90-100 (122-136)	125-140 (170-190)
	.625	125-140 (170-190)	175-190 (240-260)
	.750	220-245 (300-330)	300-330 (410-450)
	.875	330-360 (450-490)	475-525 (645-710)
	1.000	475-525 (645-710)	725-800 (985-1085)
	1.125	650-720 (880-975)	1050-1175 (1425-1600)
	1.250	900-1000 (1200-1360)	1475-1625 (2000-2200)
	1.375	1200-1350 (1630-1830)	2000-2200 (2720-2980)
	1.500	1500-1650 (2040-2240)	2600-2850 (3530-3870)
	1.625	2000-2800 (2720-2980)	3450-3800 (4680-5150)
	1.750	2500-2750 (3390-3730)	4300-4800 (5830-6500)
	1.875	3150-3500 (4270-4750)	5500-6100 (5830-6500)
	2.000	3800-4200 (5150-5700)	6500-7200 (8800-9800)

---

**TORQUE SPECIFICATIONS FOR BOLTS (CONT'D)****Torque For General Metric Bolts**

Thread Size (Dia. x Pitch)	Material		
	Head Mark 4	Head Mark 7	Head Mark 10
M 5 x 0.8		3-4 ft.-lb. (4-5 N•m)	
M 6 x 1.0		6-7 ft.-lb. (8-9 N•m)	6-9 ft.-lb. (8-12 N•m)
M 8 x 1.25	6-9 ft.-lb. (8-12 N•m)	11-16 ft.-lb. (15-22 N•m)	18-25 ft.-lb. (24-34 N•m)
M 10 x 1.25	13-18 ft.-lb. (18-24 N•m)	22-30 ft.-lb. (30-41 N•m)	36-50 ft.-lb. (49-68 N•m)
M 12 x 1.25	22-30 ft.-lb. (30-41 N•m)	40-54 ft.-lb. (54-73 N•m)	69-87 ft.-lb. (94-118 N•m)
M 14 x 1.5	36-50 ft.-lb. (49-68 N•m)	58-80 ft.-lb. (79-108 N•m)	116-137 ft.-lb. (157- 186 N•m)

## HYDRAULIC CONNECTION SPECIFICATIONS

### O-ring Face Seal Connection

# IMPORTANT

When repairing hydrostatic and hydraulic systems, clean the work area before disassembly and keep all parts clean. Always use caps and plugs on hoses, tubelines and ports to keep dirt out. Dirt can quickly damage the system.

I-2003-0888

Figure SPEC-50-15

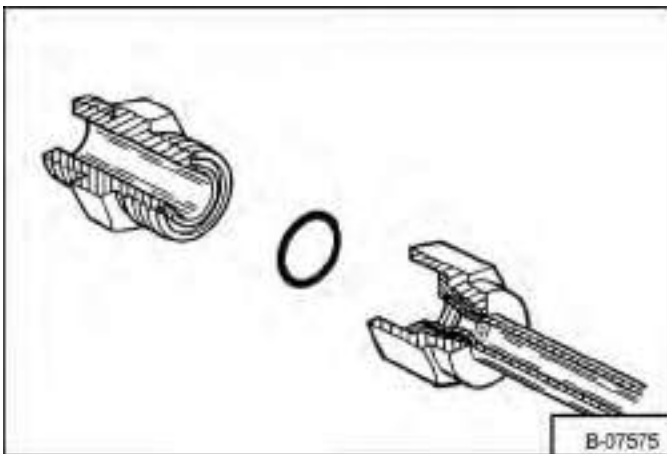

When the fitting is tightened, you can *feel* when the fitting is tight to eliminate leakage caused by under or over torqued fittings. Use vaseline petroleum jelly to hold the O-ring in position until the fittings are assembled [Figure SPEC-50-15].

### Straight Thread O-ring Fitting

Figure SPEC-50-16

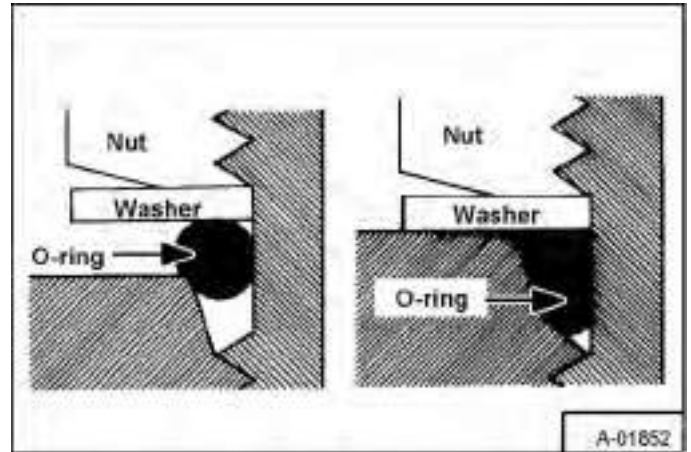

Lubricate the O-ring before installing the fitting. Loosen the jam nut and install the fitting. Tighten the jam nut until the washer is tight against the surface [Figure SPEC-50-16].

### Tubelines And Hoses

Replace any tubelines that are bent or flattened. They will restrict flow, which will slow hydraulic action and cause heat.

Replace hoses which show signs of wear, damage or weather cracked rubber.

Always use two wrenches when loosening and tightening hose or tubeline fittings.

## HYDRAULIC CONNECTION SPECIFICATIONS (CONT'D)

### Flare Fitting

Use the following procedure to tighten the flare fitting:

Figure SPEC-50-17

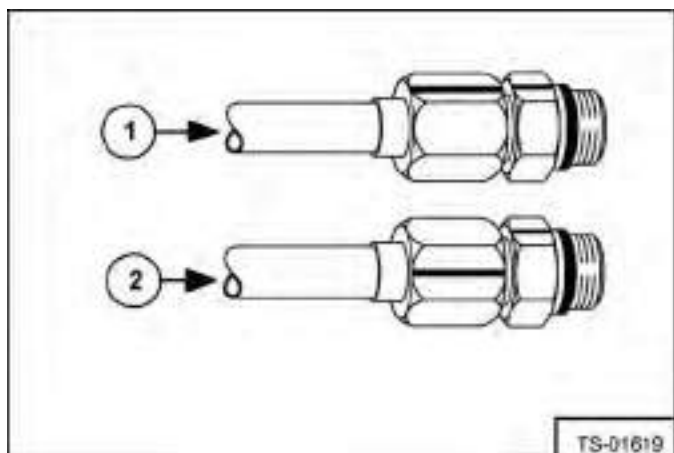

Tighten the nut until it makes contact with the seat. Make a mark across the *flats* of both the male and female parts of the connection (Item 1) [Figure SPEC-50-17].

Use the chart below to find the correct tightness needed (Item 2) [Figure SPEC-50-17]. If the fitting leaks after tightening, disconnect it and inspect the seat area for damage.

FLARE FITTING TIGHTENING TORQUE

WRENCH SIZE	TUBELINE OUTSIDE DIAMETER	THREAD SIZE	TORQUE FT.-LB. (N•M)	NEW ROTATE NO. OF HEX FLATS	RE-ASSEMBLY ROTATE NO. OF HEX FLATS
5/8"	5/16"	1/2" - 20	17 (23)	2-1/2	1
11/16"	3/8"	9/16" - 18	22 (30)	2	1
7/8"	1/2"	3/4" - 16	40 (54)	2	1
1"	5/8"	7/8" - 14	60 (81)	1-1/2	1
1-1/4"	3/4"	1-1/16" - 12	84 (114)	1	3/4
1-3/8"	1"	1-5/16" - 12	118 (160)	3/4	3/4

**HYDRAULIC CONNECTION SPECIFICATIONS  
(CONT'D)**

**O-ring Flare Fitting**

**Figure SPEC-50-18**

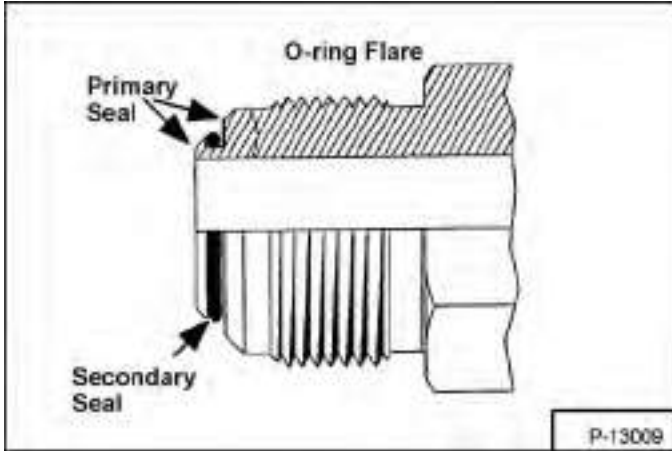

The flare is the primary seal, the O-ring is the secondary seal and helps absorb vibration and pressure pulses at the connection [Figure SPEC-50-18].

If necessary, the O-ring-flare fitting can be used without an O-ring.

Use the following procedure to tighten the O-ring flare fitting.

**Figure SPEC-50-19**

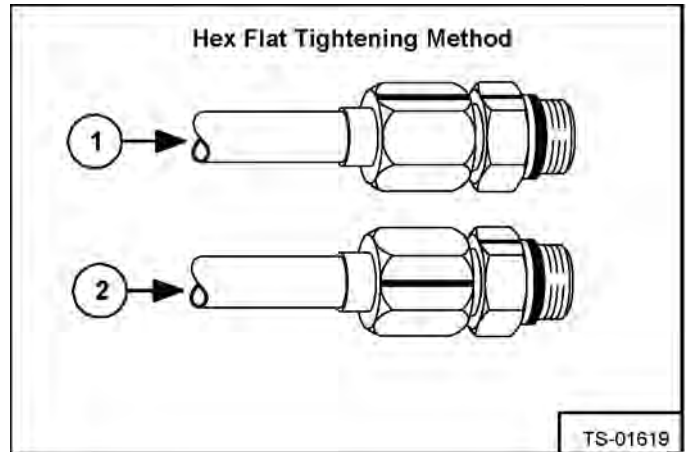

Tighten the nut until it contacts with the seat. Make a mark across the flats of both the male and female parts of the connection (Item 1) [Figure SPEC-50-19].

Use the chart below to find the correct tightness needed (Item 2) [Figure SPEC-50-19]. If the fitting leaks after tightening, disconnect it and inspect the seat area for damage.

FLARE FITTING TIGHTENING TORQUE					
WRENCH SIZE	TUBELINE OUTSIDE DIAMETER	THREAD SIZE	* TORQUE FT.-LB. (N•M)	** NEW ROTATE NO. OF HEX FLATS	*** RE-ASSEMBLY ROTATE NO. OF HEX FLATS
5/8"	5/16"	1/2" - 20	17 (23)	2-1/2	1
11/16"	3/8"	9/16" - 18	22 (30)	2	1
7/8"	1/2"	3/4" - 16	40 (54)	2	1
1"	5/8"	7/8" - 14	60 (81)	1-1/2	1
1-1/4"	3/4"	1-1/16" - 12	84 (114)	1	3/4
1-3/8"	1"	1-5/16" - 12	118 (160)	3/4	3/4

\* If a torque wrench is used to tighten a new fitting to a used hose / tubeline.

\* If a torque wrench is used to tighten a used fitting to a new hose / tubeline.

\* If a torque wrench is used to tighten a new fitting to a new hose / tubeline.

\*\* If using the hex flat tightening method to tighten a new fitting to a new hose / tubeline.

\*\* If using the hex flat tightening method to tighten a new fitting to a used hose / tubeline.

\*\*\* If using the hex flat tightening method to tighten a used fitting to a new hose / tubeline.

## HYDRAULIC CONNECTION SPECIFICATIONS (CONT'D)

### O-ring Flare Fitting (Cont'd)

**NOTE:** O-ring flare fittings are not recommended in all applications. Use the standard flare fittings in these applications.

Do not use a O-ring flare fitting when a copper bonnet orifice is used. When tightened the connection at the bonnet may distort the flare face and prevent it from sealing.

Figure SPEC-50-20

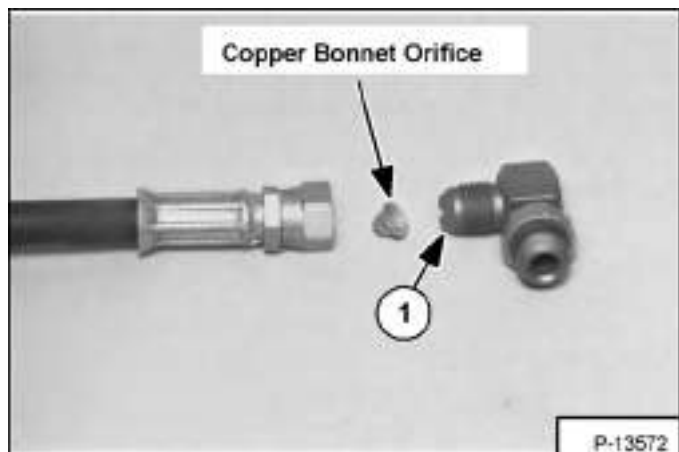

Use a standard flare fitting (Item 1) [Figure SPEC-50-20] as shown.

When a O-ring flare fitting is used as a straight thread port adapter the O-ring flare face is not used to seal. The O-ring may come off the fitting and enter the system.

Figure SPEC-50-21

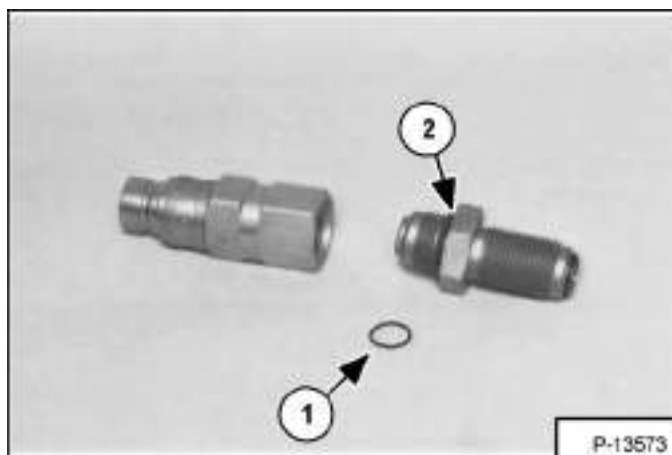

Always remove the O-ring (Item 1) [Figure SPEC-50-21] from the flare face as shown.

An O-ring (Item 2) [Figure SPEC-50-21] is added to the flat boss of the fitting to seal the connection in this application.

**HYDRAULIC CONNECTION SPECIFICATIONS  
(CONT'D)**

**Port Seal Fitting**

**Figure SPEC-50-22**

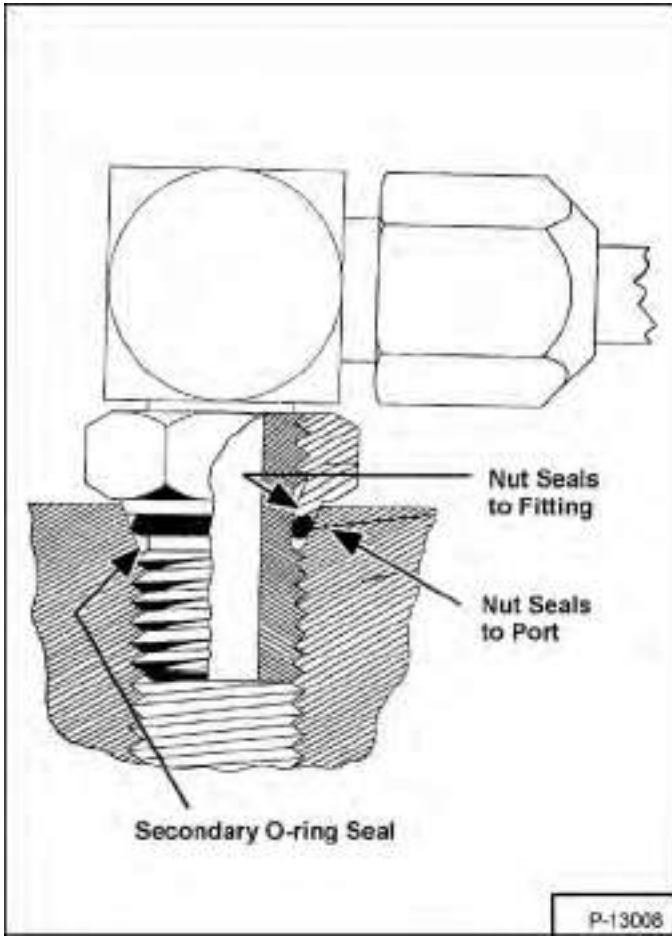

The nut is the primary seal, the O-ring is the secondary seal and helps absorb vibration and pressure pulses at the connection [Figure SPEC-50-22].

The hex portion of the nut does not contact the surface of the component when the nut is tight.

Use the following procedure to tighten the port seal fitting:

Port seal and nut, washer and O-ring (O-ring Boss) fittings use the same tightening torque valve chart.

If a torque wrench cannot be used, use the following method.

Tighten the nut until it just makes metal to metal contact, you can feel the resistance.

Tighten the nut with a wrench no more than one hex flat maximum.

Do not over tighten the port seal fitting.

**NOTE:** If a torque wrench cannot be used, use the hex flat tightening method as an approximate guideline.

**NOTE:** Port seal fittings are not recommended in all applications. Use O-ring boss fittings in these applications.

PORT SEAL AND O-RING BOSS TIGHTENING TORQUE		
FITTING NUT WRENCH SIZE	THREAD SIZE	TORQUE FT.-LB. (N•M)
11/16"	9/16" - 18	22 (30)
15/16"	3/4" - 16	40 (54)
1-1/8"	7/8" - 14	60 (81)
1-1/4"	1-1/16" - 12	84 (114)
1-1/2"	1-5/16" - 12	118 (160)

**Figure SPEC-50-23**

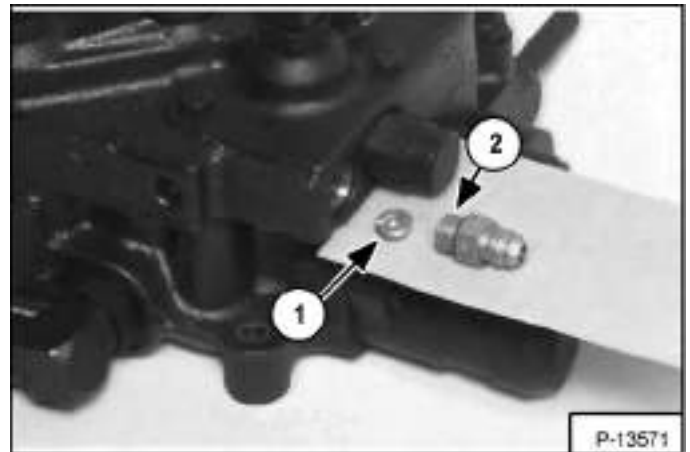

Do not use port seal fittings when a thread in orifice (Item 1) [Figure SPEC-50-23] is used in the port. The orifice may interfere with the fitting and prevent it from sealing.

Use an O-ring boss fitting (Item 2) [Figure SPEC-50-23] as shown.



**Bobcat®**



---

## HYDRAULIC / HYDROSTATIC FLUID SPECIFICATIONS

### Specifications

Use Bobcat axle fluid (P/N 100032-06A), for the transfer case, planetaries and axle housings.

Use Bobcat hydraulic / hydrostatic transmission fluid (P/N 6563328). If this fluid is not available, use 10W-30 or 10W-40 SAE Motor Oil (5W-30 for 0°F [-18°C] and Below).

DO NOT use automatic transmission fluids in the machine or permanent damage to the hydraulic/hydrostatic system will result.

## **WARNING**

Diesel fuel or hydraulic fluid under pressure can penetrate skin or eyes, causing serious injury or death. Fluid leaks under pressure may not be visible. Use a piece of cardboard or wood to find leaks. Do not use your bare hand. Wear safety goggles. If fluid enters skin or eyes, get immediate medical attention from a physician familiar with this injury.

W-2072-0496

---

When temperatures below zero degree F (-18°C) are common, the machine must be kept in a warm building. Extra warm-up time must be used each time the machine is started during cold temperature conditions. Cold fluid will not flow easily and it makes action on the hydraulic function slower. Loss of fluid flow to the hydrostatic pump can cause damage in less than 60 seconds.

## **WARNING**

During cold weather (32°F [0°C] and below), do not operate machine until the engine has run for at least five minutes at less than half throttle. This warm-up period is necessary for foot pedal operation and safe stopping. Do not operate controls during warm-up period.

When temperatures are below -20°F (-30°C), the hydrostatic oil must be heated or kept warm. The hydrostatic system will not get enough oil at low temperatures. Park the machine in an area where the temperature will be above 0°F (-18°C) if possible.

W-2027-1285

---



**Bobcat®**

---

**CONVERSIONS****Decimal And Millimeter Equivalents**

<b>FRACTIONS</b>	<b>DECIMALS</b>	<b>MM</b>	<b>FRACTIONS</b>	<b>DECIMALS</b>	<b>MM</b>
1/64	0.015625	0.397	33/64	0.515625	13.097
1/32	0.03125	0.794	17/32	0.53125	13.494
3/64	0.046875	1.191	35/64	0.546875	13.891
1/16	0.0625	1.588	9/16	0.5625	14.288
5/64	0.078125	1.984	37/64	0.578125	14.684
3/32	0.09375	2.381	19/32	0.59375	15.081
7/64	0.109375	2.778	39/64	0.609375	15.478
1/8	0.1250	3.175	5/8	0.6250	15.875
9/64	0.140625	3.572	41/64	0.640625	16.272
5/32	0.15625	3.969	21/32	0.65625	16.669
11/64	0.171875	4.366	43/64	0.671875	17.066
3/16	0.1876	4.762	11/16	0.6875	17.462
13/64	0.203125	5.159	45/64	0.703125	17.859
7/32	0.21875	5.556	23/32	0.71875	18.256
15/64	0.234375	5.953	47/64	0.734375	18.653
1/4	0.2500	6.350	3/4	0.7500	19.050
17/64	0.265625	6.747	49/64	0.765625	19.447
9/32	0.28125	7.144	25/32	0.78125	19.844
19/64	0.296875	7.541	51/64	0.796875	20.241
5/16	0.3125	7.938	13/16	0.8125	20.638
21/64	0.328125	8.334	53/64	0.828125	21.034
11/32	0.34375	8.731	27/32	0.84375	21.431
23/64	0.359375	9.128	55/64	0.859375	21.828
3/8	0.3750	9.525	7/8	0.8750	22.225
25/64	0.390625	9.922	57/64	0.890625	22.622
13/32	0.40625	10.319	29/32	0.90625	23.019
27/64	0.421875	10.716	59/64	0.921875	23.416
7/16	0.4375	11.112	15/16	0.9375	23.812
29/64	0.453125	11.509	61/64	0.953125	24.209
15/32	0.46875	11.906	31/32	0.96875	24.606
31/64	0.484375	12.303	63/64	0.984375	25.003
1/2	0.5000	12.700	1	1.000	25.400
1 mm = 0.03937"	0.001" = 0.0254 mm				

**CONVERSIONS (CONT'D)****U.S. To Metric Conversion**

	<b>TO CONVERT</b>	<b>INTO</b>	<b>MULTIPLY BY</b>
<b>LINEAR MEASUREMENT</b>	Miles	Kilometers	1.609
	Yards	Meters	0.9144
	Feet	Meters	0.3048
	Feet	Centimeters	30.48
	Inches	Meters	0.0254
	Inches	Centimeters	2.54
	Inches	Millimeters	25.4
<b>AREA</b>	Square Miles	Square Kilometers	2.59
	Square Feet	Square Meters	0.0929
	Square Inches	Square Centimeters	6.452
	Acre	Hectare	0.4047
<b>VOLUME</b>	Cubic Yards	Cubic Meters	0.7646
	Cubic Feet	Cubic Meters	0.02832
	Cubic Inches	Cubic Centimeters	16.39
<b>WEIGHT</b>	Tons (Short)	Metric Tons	0.9078
	Pounds	Kilograms	0.4536
	Ounces (Avdp.)	Grams	28.3495
<b>PRESSURE</b>	Pounds/Sq. In.	Kilopascal	6.895
<b>WORK</b>	Foot-Pounds	Newton-Metre	1.356
<b>LIQUID VOLUME</b>	Quarts	Liters	0.9463
	Gallons	Liters	3.785
<b>LIQUID FLOW</b>	Gallons/Minute	Liters/Minute	3.785
<b>TEMPERATURE</b>	Fahrenheit	Celsius	1. Subtract 32° 2. Multiply by 5/9