

OPERATING MANUAL

ELECTRIC STANDDRIVE

E30-40HSD (A219)

99.815



DO NOT REMOVE THIS MANUAL
FROM THIS UNIT

LIFT TRUCK MODEL _____ SERIAL NUMBER _____
ENGINE MODEL _____ SERIAL NUMBER _____
TRANSMISSION TYPE _____ SERIAL NUMBER _____
UPRIGHT LIFT HEIGHT _____ GROUP NUMBER _____
CARRIAGE TYPE _____ GROUP NUMBER _____
DRIVE TIRE SIZE _____ STEERING TIRE SIZE _____

SPECIAL EQUIPMENT OR ATTACHMENTS

REGISTERED TRADEMARKS

Hyster, , SpaceSaver, Straddle Truck, Karry Crane, Yardmaster, Monotrol, OrderMaster, SpaceMaster, RackLoader, SitDrive and StandDrive are registered trademarks of Hyster Company.

CONTENTS

CONTENTS	1	Maintenance Schedule	41
FOREWORD	2	How to Move a Disabled Lift Truck	45
WARNING	4	How to Tow the Lift Truck	46
MODEL DESCRIPTION	7	How to Put a Lift Truck on Blocks	46
Nameplate	8	Checks with the Key Switch OFF	49
Warning Labels	9	Hydraulic System	49
Major Components of the Lift Truck	12	Forks	49
Instruments and Controls	13	Inspection of Masts, Forks, and Lift Chains	51
OPERATING PROCEDURES	20	Steering System	53
General	20	Battery	53
Inspections Before Operating	22	Tires and Wheels	55
Operating Techniques	24	Safety Labels	55
Starting Sequence	27	Checks with the Key Switch ON	56
Driving and Direction Changes	27	Indications, Horn, and Fuses	56
Steering (Turning)	27	Control Levers and Pedals	58
Load Handling - General	29	Lift System Operation	56
Lifting, Lowering, and Tilting	30	Brakes	57
How to Engage and Disengage a Load	32	Steering System	57
Traveling	34	How to Charge the Battery	57
Highway Trucks, Railroad Cars, and Docks	38	How to Change the Battery	59
Attachments	39	Changes to Overhead Guard	62
Stopping	39	Tires and Wheels	62
Parking	39	Battery Specifications	64
MAINTENANCE	40	Battery Retention Setup	65
General	40		

FOREWORD**To OWNERS, USERS, and OPERATORS:**

The safe and efficient operation of a lift truck requires skill and alertness on the part of the operator. To develop the skill required the operator must:

- Receive training pursuant to OSHA 1910.178 (1), 12/98 in the proper operation of this lift truck.
- Understand the capabilities and limitations of the lift truck.
- Become familiar with the construction of the lift truck and see that it is maintained in good condition.
- Read and understand the warnings and operating procedures contained in this manual.

In addition a qualified person, experienced in lift truck operation, must guide a new operator through several driving and load handling operations before the new operator attempts to operate the lift truck alone.

It is the responsibility of the employer to make sure that the operator can see, hear, and has the physical and mental ability to operate the equipment safely.

Various laws and regulations require the employer to train lift truck operators. These laws and regulations include

Occupational Safety and Health Act (OSHA) (USA)
Canada Material Handling Regulations

NOTE: A comprehensive operator training program is available from HYSTER COMPANY. For further details contact your HYSTER Lift Truck Dealer.

This OPERATING MANUAL is stored in the container in the operator's compartment. Read and understand this manual before operating the lift truck. This is a permanent reference and must be available for use at all times.

This OPERATING MANUAL contains information necessary for the operation and maintenance of a basic lift truck. Optional equipment is sometimes installed that can change some operating characteristics described in this manual. Make sure the necessary instructions are available and understood before operating the lift truck.

FOREWORD

This OPERATING MANUAL contains information necessary for the operation and maintenance of a basic fork lift truck. Optional equipment is sometimes installed that can change some operating characteristics described in this manual. Make sure the necessary instructions are available and understood before operating the lift truck.

The "Guide for Users of Industrial Lift Trucks" describes lift truck safety, good maintenance practices, and training programs. Additional copies are available from your dealer for HYSTER lift trucks.

Additional information that describes the safe operation and use of lift trucks is available from the following sources:

- Employment safety and health standards or regulations (Examples: "Occupational Safety and Health Standards (USA)," "Canada Material Handling Regulations.")
- Safety codes and standards (Examples: American National Standard, ANSI B56.1, *Safety Standard for Low Lift and High Lift Trucks*).
- Publications from government safety agencies, government insurers, private insurers and private

organizations (Example: *Accident Prevention for Industrial Operations* from the National Safety Council)

- "Guide for Users of Industrial Lift Trucks" describes lift truck safety, good maintenance practices, and training programs, shipped with your lift truck. Additional copies are available from your dealer for HYSTER lift trucks.

NOTE: HYSTER lift trucks are not intended for use on public roads.

NOTE: Throughout this manual, the terms right, left, front and rear relate to the viewpoint of an operator standing in the operator's compartment and facing the forks.

NOTE: The following symbols and words indicate safety information in this manual:



WARNING: Indicates a condition that can cause injury or death.



CAUTION: Indicates a condition that can cause property damage!

WARNING

FAILURE TO FOLLOW THESE INSTRUCTIONS CAN CAUSE SERIOUS INJURY OR DEATH! AUTHORIZED, TRAINED OPERATOR ONLY!

KNOW THE EQUIPMENT:

- Know operating, inspection and maintenance instructions in Operating Manual
- **DO NOT** operate or repair truck unless trained and authorized
- Inspect truck before use
- **DO NOT** operate if truck needs repair. Tag truck and remove key. Repair truck before use
- Use auxiliary equipment (attachments) for intended purpose only.
- Make sure truck is equipped with overhead guard and load backrest adequate for the load

KNOW YOUR LOADS:

- Avoid lifting or hitting anything that can fall.
- Handle only stable loads that are within capacity (see nameplate)

- Space forks as far apart as possible and center the load between forks
- Keep load against carriage. Do not handle loose loads higher than load backrest.

KNOW THE AREA:

- Never enter a trailer or railroad car unless its wheels are blocked
- Watch floor strength.
- Check dockboard width, capacity, and security.
- Fill fuel tank or charge battery only in designated area.
- Avoid sparks or open flame. Provide ventilation.
- When fueling turn off engine.
- When charging battery, keep vent caps clear
- Disconnect battery during servicing
- **DO NOT** operate on a ramp with a grade of more than 10 percent.

WARNING

**FAILURE TO FOLLOW THESE INSTRUCTIONS CAN CAUSE SERIOUS INJURY OR DEATH!
AUTHORIZED, TRAINED OPERATOR ONLY!**

LOOK WHERE YOU ARE GOING:

- Travel in reverse if necessary to see.
- Make sure tailswing area is clear.
- Sound horn at intersections. Watch clearances, especially overhead.

USE COMMON SENSE:

- Never transport people on any part of the truck.
- To lift people, use secured safety platform
- Allow no one under or near lift mechanism.

- Do not move truck if anyone is between truck and stationary object.
- Keep arms, legs, and head inside operator's compartment.
- Yield right-of-way to pedestrians.
- Observe traffic rules.
- Be in complete control at all times.
- When leaving truck, lower carriage, and when parking, shut off power.
- Block wheels on inclines.

WARNING

**FAILURE TO FOLLOW THESE INSTRUCTIONS CAN CAUSE SERIOUS INJURY OR DEATH!
AUTHORIZED, TRAINED OPERATOR ONLY!**

PROTECT YOURSELF:

- Avoid bumps, holes, and loose materials.
- Avoid sudden starts or stops.
- Do not turn on or angle across an incline.
- Travel on inclines with load uphill or when unloaded with lift mechanism downhill.
- Tilt slowly and smoothly.
- Lift or lower with upright vertical or tilted slightly back.
- Travel with carriage as low as possible and tilted back.

- Go slowly when turning, use special care when traveling without a load.

**FAILURE TO FOLLOW THESE INSTRUCTIONS CAN
CAUSE THE LIFT TRUCK TO TIP.**

Although there is no sure way in all circumstances to avoid injury, where possible, in the event of an imminent tipover or off the dock accident, the operator should STEP OFF AND AWAY FROM THE TRUCK. These actions are intended to reduce the risk of serious injury or death.

MODEL DESCRIPTION

This Operating Manual describes the operation and basic maintenance of the HYSTER E30-40HSD electric stand-up counterbalanced lift trucks. These trucks have load handling capacities of 3,000 to 4,000 pounds. The truck is available in two configurations: rear entry, or forward stance and rear entry, side stance. The trucks are steered by the rear (steel) wheel and powered by the front (drive) wheels. All trucks are equipped with solid rubber or polyurethane tires.

A multi-function control handle is standard on all trucks. The multi-function handle allows the operator to travel, lift/lower and/or tilt or side-shift. The horn button and the optional auxiliary functions are also located on the multi-function handle.

A 36 volt battery supplies power for the truck. These trucks are steered by the rear (steer) wheel(s) through a power steering system. Electronic traction control provides dual front, continuous, differential drive.

The lift truck has a braking function called "Plugging." When the lift truck is traveling in one direction and the multi-function handle is changed to the opposite direction, the direction of current flow through the motor changes, causing electri-

cal braking (Plugging). This is the preferred method of stopping the truck. The dual electric disc brakes are designed to function primarily as the parking brake.

Removable panels provide access to all critical components, including: the lift pump, drive motors, electronics, power steering assembly and the battery. The battery can be removed from either side of the lift truck. A roller rack under the battery permits easy battery movement.

All lift trucks have operator protection equipment. The overhead guards are intended to offer reasonable protection to the operator from falling objects, but cannot protect against every possible impact. Therefore, it must not be considered a substitute for good judgement and care when handling loads. Do not remove the overhead guard.

The load backrest extension is installed to keep loose parts of the load from falling back toward the operator. It must be high enough with openings small enough to prevent parts of the load from falling backwards if a load backrest extension different from the one installed on your truck is required, contact your HYSTER lift truck dealer.

MODEL DESCRIPTION NAMEPLATE

The lift truck nameplate is located in the operator's compartment. The rated capacity of the lift truck is shown on the lift truck nameplate. The capacity is listed in terms of weight and load center. The weight is specified in kilograms (kg) or pounds (lb). The load center is specified in millimeters (mm) or inches (in). Make sure the nameplate data is complete and fully understood before operating the truck.

WARNING: Any change to the lift truck or its equipment can change the capacity. The lift truck must be rated as equipped and the nameplate must show the new capacity. OSHA requires that modifications which affect the capacity and safe operation of the lift truck must have the manufacturer's prior written approval.

The rated capacity for a lift truck, as it is equipped, is shown on the nameplate. If the lift truck has special load handling equipment, the rating will be shown on the nameplate. If the lift truck nameplate does not show the rated capacity, or if the lift truck equipment, including the battery, does not match that shown on the nameplate, the lift truck must not be operated until its capacity is known.

HYSTEF

When a lift truck is shipped incomplete from the factory, the nameplate is covered by a label. If your lift truck has this type of label, do not operate the lift truck. Contact your HYTEL lift truck dealer to obtain a complete nameplate.

WARNING: The lift truck capacity can change with different types of tires. Make sure the capacity on the nameplate is for the type of tires installed on the truck.

ATTENTION

Read Capacity and Weight Labels

Read Capacity and Weight Labels on all equipment.

WARNING: Tires

Capacity and weight labels are based on the tires shown. Capacity and weight labels are not valid if the tires are not as shown.

LITTRUCK MODEL

Serial No. _____

Attachment _____

Truck Model Name _____

Truck Model No. _____

Truck Model Description _____

Truck Model Year _____

The _____

For _____

Program _____

Steps _____

Time _____

Mode _____

Max. Lift _____

Max. Lift _____

Max. Lift _____

Max. Lift _____

Max. Lift _____

MAXIMUM CAPACITY		LOAD WEIGHT		LOAD CENTER	
kg	lb	mm	in.	mm	in.
1	2	3	4	5	6
7	8	9	10	11	12

NO193026

FIGURE 1. NAMEPLATE AND LABEL

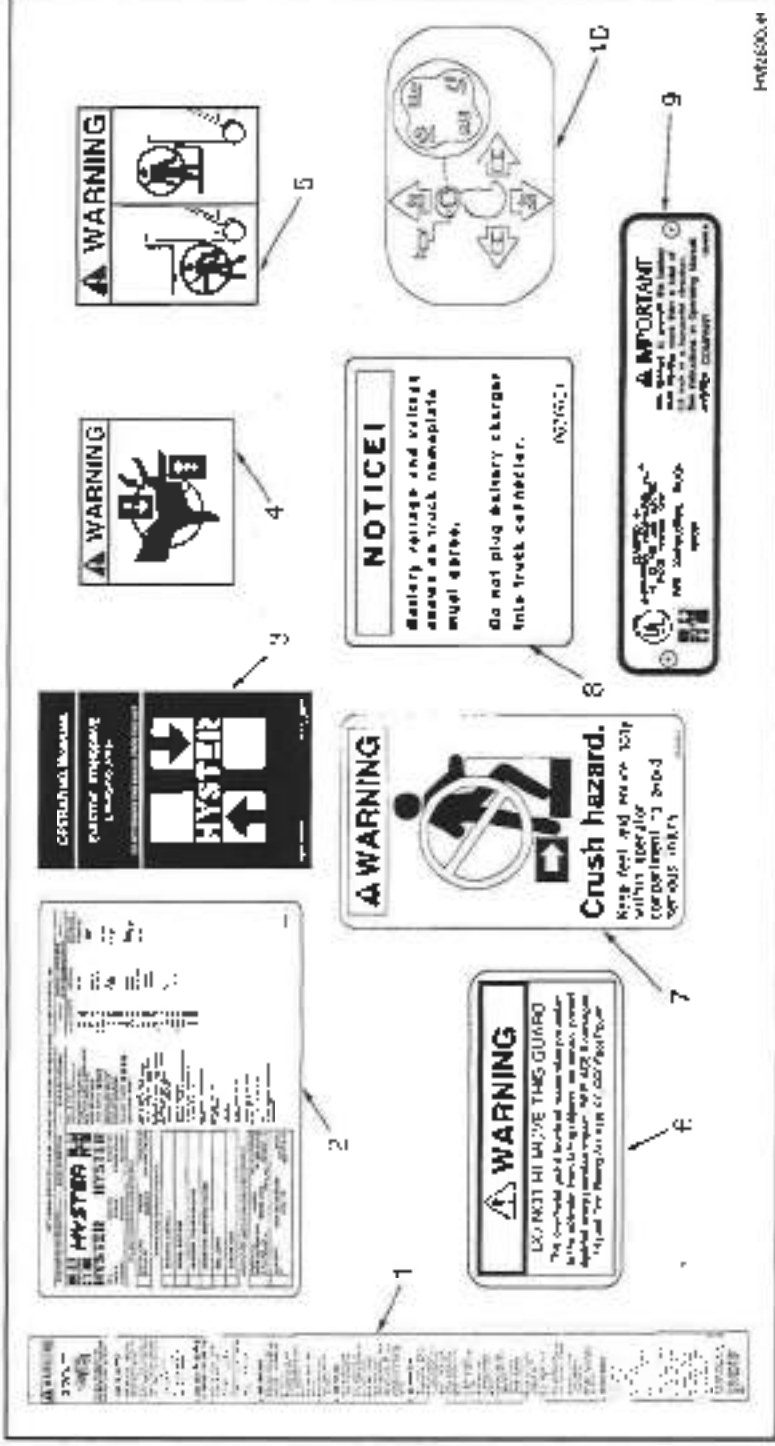

FIGURE 2. SAFETY AND INSTRUCTION LABELS

- 1 Label, Operator Warning
- 2 Label, Do Not Overload
- 3 Manual, Operating
- 4 Label, Pinch Points
- 5 Label, Mast Warning
- 6 Label, Overhead Guard
- 7 Label, Battery Size
- 8 Label, Battery Connector
- 9 Label, Underwriters Lab.
- 10 Label, Control Handle
- 11 Label, Mast Warning

Operator Warning Label

The Operator Warning Label is a long, narrow label affixed to the inside of the rear leg of the overhead guard. See item 1, FIGURE 2. Due to the importance of information found on this label it has been reprinted below.



WARNING

Authorized, trained operator only. Read Manual. Failure to observe the following rules can cause serious injury or death.

1. Know the equipment:

- Know operating, inspection, and maintenance instructions and warnings in Manual
- Inspect lift truck before use. Do not operate if truck needs repair. Tag truck and remove key. Repair truck before use.
- Use attachments for intended purposes only.
- Make sure truck is equipped with overhead guard and load backrest adequate for the load

2. Look where you are going: If you can't see don't go!

- Travel in reverse if load blocks forward vision
- Make sure tail swing area is clear before turning
- Sound horn at intersections or wherever vision is blocked.
- Watch clearances, especially overhead

3. Know your loads:

- Handle only stable loads within specified weight and load center. See Nameplate on this truck.
- Space forks as far apart as load allows and center load between forks. See Nameplate on this truck.
- Keep load against load backrest
- Do not handle loose loads higher than the load backrest.

4. Know the area:

- Check dockboard width capacity and security.
- Never enter a trailer or railroad car unless its wheels are blocked.
- Watch floor strength

- Charge battery only in designated area. Avoid sparks or open flame. Provide ventilation. When charging, keep caps clear. Disconnect battery during service.
- 5. **Use common sense:**
 - Never transport people on any part of the truck.
 - Do not use truck to lift people unless there is no other practical option. Then use only a securely attached special work platform. Follow instructions in manual.
 - Allow no one under or near lift mechanism or load.
 - Do not move truck if anyone is between truck and stationary object.
 - Keep arms, legs, and head inside operator's compartment.
 - Operate truck only from the designated operator's position.
 - Observe traffic rules. Yield right of way to pedestrians.
 - Be in complete control at all times.
- Before dismounting, neutralize travel control, lower carriage, and set the brake.
- Do not exit truck until it has completely stopped moving.
- When parking, shut off power. Block wheels on inclines.
- 5. **Protect yourself:**
 - Avoid bumps, holes, loose materials and slippery areas.
 - Avoid sudden starts or stops. Operate all controls smoothly.
 - Never turn on or angle across an incline. Travel slowly.
 - Travel on inclines with load uphill or unloaded with mast downhill.
 - Tilt slowly and smoothly. Lift and lower with mast or carriage vertical or tilted slightly back. Use minimum tilt when stacking elevated loads.
 - Travel with carriage as low as possible and tilted back.
 - Slow down before turning, especially without a load.
 - **FAILURE TO FOLLOW THESE INSTRUCTIONS CAN CAUSE THE LIFT TRUCK TO TIP OVER.**

MODEL DESCRIPTION

- 1. Operator Compartment
- 2. Battery Gate
- 3. Drive Wheel
- 4. Carriage
- 5. Forks
- 6. Mast
- 7. Overhead Guard

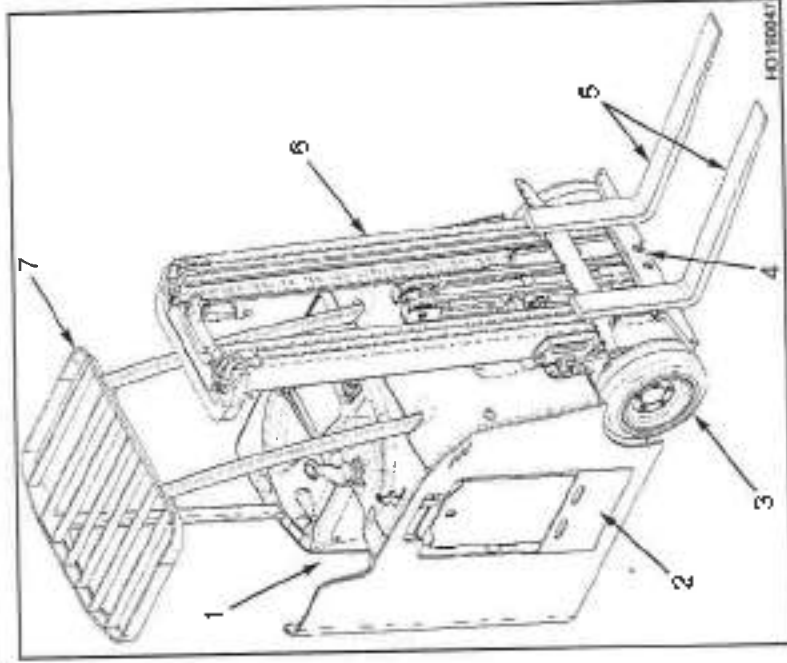
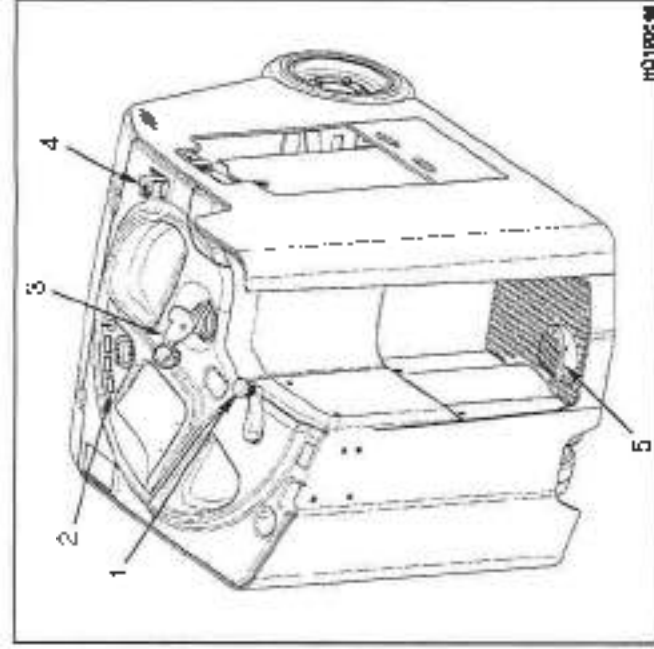

FIGURE 3. MAJOR COMPONENTS



1. Steering Tiller
2. Operator's Display
3. Multi-function Handle
4. Emergency Disconnect Lever
5. Brake Pedal

FIGURE 4. INSTRUMENTS AND CONTROLS

Table 1. Instruments and Controls



ITEM NO.	ITEM	FUNCTION
2	Battery Indicator/Hourmeter  NAO1366	<p>The Battery Indicator has five green, yellow, and red Light-Emitting Diodes (LEDs) to display the battery's state of charge. The far right (green) LED indicates a charged battery. The far left (red) LED indicates a discharged battery. As power is used, the LEDs to the left are successively lit and the colors change from green to yellow to red as the battery discharges. The red LED on the left will be lit solidly to indicate a nearly discharged battery. The battery should be charged at this time. If the last LED is alternately flashing, the battery MUST be charged. The lift function will be interrupted at this point. Continued operation with the red LED flashing can damage the battery, the motors, or the contactors. The battery indicator will automatically reset approximately one minute after a charged battery is connected.</p> <p>The Hourmeter records lift truck hours whenever the brake is pressed down. A liquid crystal display (LCD) shows the current software version and hourmeter reading whenever the key switch is turned ON.</p> <p>The LCD will also display diagnostic messages in the event of a fault.</p> <p>Note: The battery discharge indicator is set at the factory for flooded batteries and must be reset by a qualified mechanic if maintenance free batteries are installed on the lift truck.</p>

Table 1. Instruments and Controls

ITEM NO.	ITEM	FUNCTION
2		<p>8. The Light Switch (optional) operates the optional work lights. It is located on the operator's display panel. To turn the work lights on, press the top of the switch; to turn them off, press the bottom of the switch.</p>
2		<p>9. The Key Switch is located on the operator's display panel. The key switch has three positions, "O," "I," and "II." No truck functions are enabled when the key is in the "O" (OFF) position. When the key is rotated clockwise to the "I" (ON) position, power is applied.</p>

MODEL DESCRIPTION

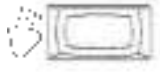
HYSTE

Table 1. Instruments and Controls

ITEM NO.	ITEM	FUNCTION
4	<p data-bbox="331 1101 388 1328">Emergency Disconnect Lever</p>  <p data-bbox="583 1140 613 1221">HO190025</p>	<p data-bbox="331 51 487 1050">The Emergency Disconnect Lever is located on the top right side of the operator's compartment. The emergency disconnect lever is used to mechanically separate the battery connectors and disconnect power from the truck. To activate the emergency disconnect, push the lever forward. To reconnect the battery align the mating halves of the connectors and pull back on lever</p>

Table 1. Instruments and Controls



ITEM NO.	ITEM	FUNCTION
5	<p data-bbox="243 1276 275 1430">Brake Pedal</p>  <p data-bbox="562 1208 583 1284">B0190006</p>	<p data-bbox="243 172 432 1172">The Brake Pedal enables the travel functions of the lift truck. It is located on the floor, on the left side of the operator's compartment. When the operator steps on the pedal, the brakes are released and the travel functions are enabled. If the multi-function handle is tilted forward or Lock before the brake pedal is engaged, travel is disabled until the multi-function handle is released to neutral. To disable travel and apply the brakes, release the brake pedal completely.</p> <p data-bbox="443 172 579 1172">  WARNING: Never use two feet on the brake pedal. DO NOT use the brake pedal to stop the lift truck except in an emergency. A full and rapid release of the brake pedal will stop the lift truck abruptly and could cause damage or injury. </p>
1	<p data-bbox="600 1260 632 1438">Steering Tiller</p>  <p data-bbox="905 1195 926 1308">B0220000</p>	<p data-bbox="621 172 821 1172">The Steering Tiller is used to maneuver the lift truck. With standard steering, traveling forward (forks first), turn the steering tiller clockwise to make the lift truck turn right; turn the steering tiller counterclockwise to make the lift truck turn left. Reverse steering is an option. If installed, when traveling forward (forks first), turn the steering tiller counterclockwise to make the lift truck turn right, turn the steering tiller clockwise to make the lift truck turn left.</p>

Table 1. Instruments and Controls

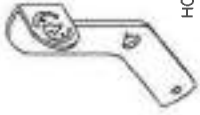
ITEM NO.	ITEM	FUNCTION
3	<p data-bbox="237 1161 268 1445">Multi-Function Handle</p>  <p data-bbox="693 1128 724 1209">80106003</p>	<p data-bbox="237 129 294 1123">The multi-function handle allows the operator to control travel, lift, tilt, sideshift, horn, and auxiliary functions.</p> <p data-bbox="325 129 609 1123">The multi-function handle controls the direction and speed of the lift truck. Travel is activated by tilting the entire control handle in the direction of travel. Pushing the control handle toward the forks makes the lift truck travel forward. To change direction, move the multi-function handle in the opposite direction the lift truck is traveling, regardless of travel speed. The lift truck will come to a stop, then accelerate in the opposite direction. This control is proportional, therefore, the farther the control handle is pushed the faster the lift truck will accelerate or decelerate. If the multi-function handle is released, it will return to neutral and the truck will coast to a stop.</p> <p data-bbox="640 129 808 1123">The multi-function handle controls the direction and speed at which the carriage moves vertically on the mast. Lift/Lower is activated by tilting the entire control handle toward the left or right side of the lift truck. If the control handle is tilted toward the right, the carriage lifts; if the control handle is tilted toward the left, the carriage lowers. The farther the lever is tilted, the faster the carriage lifts or lowers.</p> <p data-bbox="829 129 903 1123">NOTE: Direction of the auxiliary functions depends on the hydraulic connections to the attachment(s).</p>

Table 1. Instruments and Controls

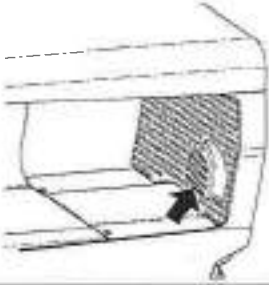
ITEM NO.	ITEM	FUNCTION
1	<p data-bbox="260 1192 289 1419">Tilt/Sideshift Disk</p> <div data-bbox="365 1117 743 1500">  <p data-bbox="365 1370 394 1500">TILT BACK</p> <p data-bbox="365 1117 394 1256">SIDESHIFT LEFT</p> <p data-bbox="701 1354 730 1500">SIDESHIFT RIGHT</p> <p data-bbox="701 1117 730 1312">TILT FORWARD</p> <p data-bbox="730 1117 743 1182">NA02265</p> </div>	<p data-bbox="268 167 491 1084">The Tilt/Sideshift Disk, located at the top of the multi-function handle lever, controls the tilting of the mast and side-shifting of the carriage. The disk is operated with the thumb of the right hand. To tilt the mast forward, press the top of the disk. To tilt the mast back, press the bottom of the disk. On lift trucks equipped with a side-shifting carriage, press the left side of the disk to move the carriage to the left, and press the right side of the disk to move the carriage to the right. Tilt and sideshift are single speed functions.</p> <p data-bbox="491 167 554 1084">The additional buttons are used to control any additional hydraulic functions, such as a push/pull, clamp attachment, etc</p>

OPERATING PROCEDURES

GENERAL

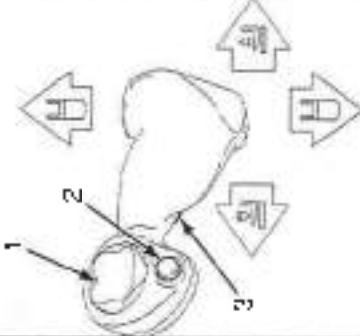
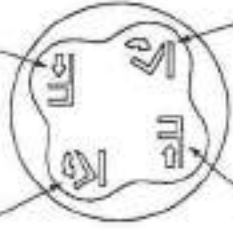
KNOW YOUR LIFT TRUCK

The fork lift truck is designed to pick up and move materials. The basic lift truck has a lift mechanism with forks on the front to engage the load. The lift mechanism lifts the load so that it can be moved and stacked.

In order to understand how the fork lift truck can pick up a load, you must first know some basic things about the lift truck.

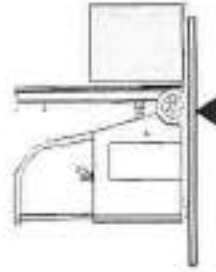

The lift truck is based on the principle of two weights balanced on opposite sides of a pivot (fulcrum). This is the same principle used for a see-saw.

In order for this principle to work for a lift truck, the load on the forks must be balanced by the weight of the lift truck. The location of the center of gravity of both the truck and the load is also a factor.

This basic principle is used for picking up a load. The ability of the lift truck to handle a load is discussed in terms of center of gravity and both forward and side stability.

STABILITY AND CENTER OF GRAVITY

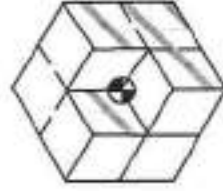

The center of gravity (CG) of any object is the single point about which the object is balanced in all directions. Every object has a CG. When the lift truck picks up a load, the truck and load have a new combined CG. The stability of the lift truck is determined

by the location of its CG, or if the truck is loaded, the combined CG.

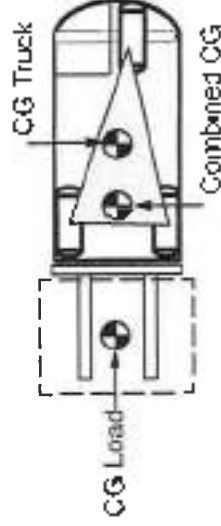

The lift truck has moving parts and therefore has a CG that moves. The CG moves up and down as mast moves up and

down. The CG moves forward and back as the mast is tilted forward and back.

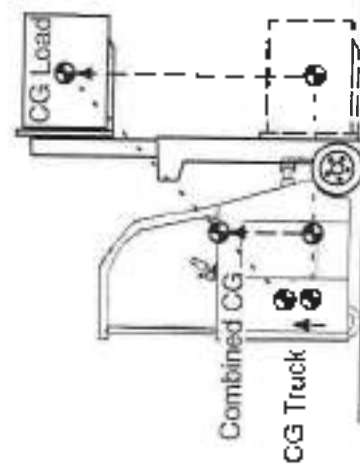

an **unloaded truck will tip over to the side easier** than a loaded truck with its load in the lowered position.

In order for the lift truck to be stable (not tip over forward or to the side) the CG must stay within the area of the lift truck represented by a triangle drawn between the drive wheels and the steer wheel.

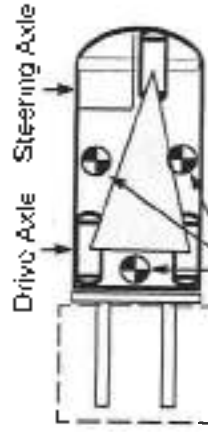

CG - Truck Will Tip Over

The center of gravity, and therefore the stability of the loaded lift truck, is affected by a number of factors, such as size, weight, shape, and position of the load; the height to which the load is raised; tire pressure; and the dynamic forces created when the truck is moving.

These dynamic forces are caused by things like acceleration, braking, turning, and operating on uneven surfaces or on an incline. These factors must be considered when traveling with an unloaded truck as well, because

if the CG moves forward of the drive wheels, the lift truck will tip forward. If the CG moves outside of the line represented by the lines drawn between the drive wheels and the steer wheel, the lift truck will tip to that side.

CAPACITY (WEIGHT AND LOAD CENTER)

The capacity of the fork lift truck is shown on the nameplate. The capacity is listed in terms of weight and load center. The weight is specified in kilograms or pounds. The load center is specified in millimeters or inches. The capacity is the maximum load that the lift truck can handle. This load

must weigh less than the maximum weight for a load center shown on the nameplate.

The load center of a load is determined by the location of its center of gravity. The load center is measured from the front face of the forks, or the load face of an attachment, to the center of gravity of the load. The location of the center of gravity in the vertical direction must be no greater than the specified horizontal dimension.

The operator must know whether or not a load is within the capacity of the lift truck before the load is handled.



WARNING: Inspect the lift truck and check the operation of the systems at the start of the day or shift. Do the inspections and checks before lift truck operation. If repair is required, put a tag on the control handle stating **DO NOT OPERATE**. Do not operate the lift truck until problems are corrected. Remove the key.

See Checks and Inspection Procedures in the Maintenance Section of this manual for detailed instructions. Also refer to Table 1 for operation and description of controls.

INSPECTIONS BEFORE OPERATING



CHECKS WITH THE KEY SWITCH OFF

Inspect the lift truck before use and every eight hours or daily as described in the MAINTENANCE Section of this OPERATING MANUAL.

Before using the lift truck, make the following checks:

- Oil level in the hydraulic tank.
- Battery weight is within the range of battery weights on the nameplate.
- Correct spacers are installed to limit horizontal battery movement.
- Electrolyte level and specific gravity of the battery. Refer to maintenance section of this manual to gain access to the battery.
- Condition of forks, carriage, chains, mast and overhead guard.
- Leaks from the hydraulic system
- Condition of wheels and tires.

WARNING: Report damage or faulty operation immediately. Do not operate a lift truck if it is damaged or does not operate correctly. A lift truck will only do its job when it is in proper working order. If repairs are required, install a tag in the operator's area stating "DO NOT OPERATE" and remove the key from the key switch.

the checks. Allow the lift truck to move only enough to check for correct operation.

CAUTION: If the lift truck is stationary during a check, make sure the direction control is in **NEUTRAL**.

After performing the visual inspections, step into the operator's compartment and turn the key switch to the "I" (ON) position. The software version will be displayed for a few seconds then the truck hourmeter hours are displayed. Listen for any unusual noise, then check the operation of the following functions as described in the **MAINTENANCE** section.

CHECKS WITH THE KEY SWITCH ON

Do not start or operate the lift truck, including any of its functions or attachments, from any place other than the designated operator's position.



Make sure that the area around the lift truck is clear before making any operational checks. Be careful when making

- Check the operator's display—no fault messages displayed, all LEDs functional.
- Check the operation of the horn.
- Operate the LIFT, TILT, and auxiliary functions to check for correct operation of the mast, carriage, and attachments
- Check the operation of the steering system
- Check the operation of the brake.

OPERATING PROCEDURES

The SRO Circuit

The lift truck is equipped with a "Stall: Return to OFF" (SRO) circuit that prevents travel of the lift truck if the starting sequence is not correct. If the control lever is moved to select a direction of travel before the key switch is turned to the "I" (ON) position or the brake pedal is depressed, the lift truck will not travel in either direction.

OPERATING TECHNIQUES



WARNING: These trucks are designed with open operator compartments to permit easy ingress and egress. Although there is no sure way in all circumstances to avoid injury, where possible, in the event of an imminent tipover or off the dock accident, the operator should **STEP OFF AND AWAY** from the truck. These actions are intended to reduce the risk of serious injury or death.



WARNING: There are a number of operations that can cause the lift truck to tip if they are not performed carefully. If you have not read the **WARNING** page in the front of this Operating Manual, do so **NOW**. As you study the following information about how to properly operate a lift truck, remember the **WARNINGS**.

HYSTER

Many people make the mistake of thinking that operating a lift truck is the same as driving an automobile. This is not true. It is true that some lift truck operating procedures are as simple and obvious as driving the family automobile. (Example: Look where you are going, start and stop smoothly, etc.) But a lift truck is a special machine designed to do a much different job than an automobile.

Because of the close areas in which a lift truck operates and its other operating characteristics (like rear wheel steering and tail swing), every operator must receive additional training even if they have a license to drive an automobile. The following discussion lists basic procedures applicable to lift truck operation.

1. Authorized and Trained Operator Only. This means the operator must be trained to drive the lift truck and it means that the operator must thoroughly understand the procedures for lift truck operation. It also means that a qualified person experienced in lift truck operation must guide the operator through several driving and load handling operations before the operator attempts to operate the lift truck alone. A basic education in proper driving and load handling techniques is absolutely necessary to prepare the new operator for proper defensive driving and to expect the unexpected.

2. Operate the lift truck only in areas that have been approved for lift truck operation.



Certain areas contain hazardous flammable gases, liquid, dust, fumes, or other materials. Lift trucks that are operated in these areas must have special fire safety approval.

These areas must be designated to show the type of lift truck approval required for operation in the area. Changes to special equipment or poor maintenance can make the lift truck lose its special approval.

3. **No Riders.** A lift truck is built for only one person, the operator. It is dangerous for anyone to ride on the forks or anywhere else on the lift truck.



WARNING: This lift truck is designed and intended for handling materials. It is not designed to lift people and may not meet the requirements of ANSI A92.6 for lifting people.

Do not use a lift truck to lift people unless it has been determined that there is no other practical option (scal-folds, elevated work plat-forms, aerial baskets, etc.) to perform the needed work.



If a lift truck is used to elevate a worker, a safety platform must be attached to the forks and carriage. The platform must be specially built to meet or exceed the requirements of ANSI B56.1. It must have a solid floor with a surface to prevent the foot of the worker from slipping, hand rail, toe board and a screen or shield at least 2 metres (7 feet) high between the people on the platform and the lift mechanism.

Before anyone is allowed in the platform, lift and lower the mast slowly with the platform in place to make sure the mast functions properly. Do not travel with people in the platform. The operator must remain at the controls. Watch for overhead obstructions.

OPERATING PROCEDURES

HYSTER

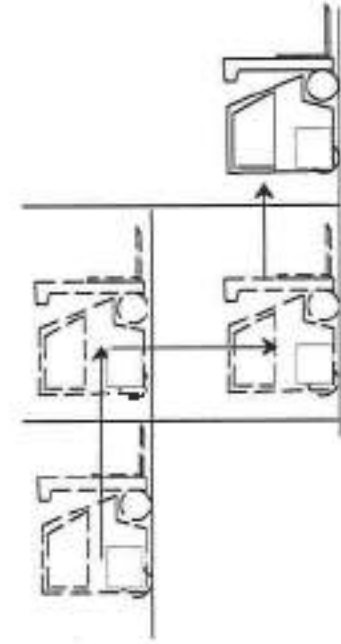

elevator is properly leveled, the lift truck must be centered so that the elevator is balanced. When the lift truck is in the proper position in the elevator, set the brakes, put the controls in **NEUTRAL**, and shut off the power. It is advisable that all other personnel leave the elevator before the lift truck enters or leaves.

5. Drive carefully, observe traffic rules and be in full control of the lift truck at all times. Be completely familiar with all the driving and load handling techniques contained in this **OPERATING MANUAL**.

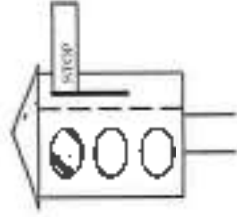

4. Do not drive a lift truck into an elevator unless authorized to do so. Approach the elevator slowly. After the

STARTING SEQUENCE

1. Make sure a charged battery of the correct voltage is installed and connected.
2. Step into operator's compartment.
3. Turn the key switch to the "I" (ON) position



The software version will be displayed for a few seconds then the truck hourmeter hours are displayed. For more information on this selection, refer to the **SERVICE MANUAL**.

4. Use only one foot to depress and hold the brake pedal down.
5. Use the left hand to steer the lift truck and the right hand to control the travel lift, tilt, and auxiliary functions

DRIVING AND DIRECTION CHANGES

Move the multi-function handle forward to go **FORWARD**. Move the handle back to go in **REVERSE**.

The operator can change the direction of travel while the lift truck is moving, by moving the multi-function handle in the opposite direction. The lift truck will come to a stop and then accelerate in the opposite direction, unless the multi-function handle is moved to the **NEUTRAL** position. This action is called "PLUGGING" and can take place at any travel speed.

STEERING (TURNING)

WARNING: Travel slowly when turning. Lift trucks can tip over even at very slow speeds. The combination of speed and the sharpness of a turn can cause a tipover.



WARNING: These trucks are designed with open operator compartments to permit easy ingress and egress. Although there is no sure way in all circumstances to avoid injury, where possible, in the event of an imminent tipover or off the dock accident, the operator should **STEP OFF AND AWAY** from the truck. These actions are intended to reduce the risk of serious injury or death.

OPERATING PROCEDURES

HYSTER

WARNING: Failure to observe the tail swing area when making a turn can injure or kill someone.



A lift truck is less stable when the forks are raised, with or without a load. Most operators can understand the need to be careful when handling loads. But some operators do not realize that a tipover can occur with an empty lift truck because similar dynamic forces are present. The lift truck will actually tip over easier when empty than when loaded with the load lowered. Rearward tilt, off-center load and uneven ground will aggravate these conditions.



Do not turn on an incline. To reduce the possibility of a tipover, a lift truck must not be driven across an incline.

During most loading or unloading operations, the operator steers with the left hand. The right hand is used to operate the travel, lift and attachment controls.

Because lift trucks are designed to work in a relatively small space, they can turn sharper than some other vehicles. Most lift trucks are steered by the rear wheels, and the rear of the lift truck can move to the side very fast during a turn. This movement is called "tailswinging". An operator must be aware of tailswinging and always check to make sure the tailswing area is clear before turning.

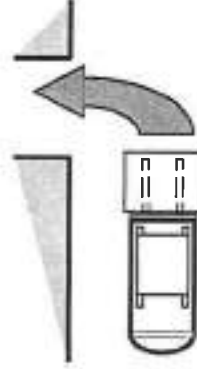
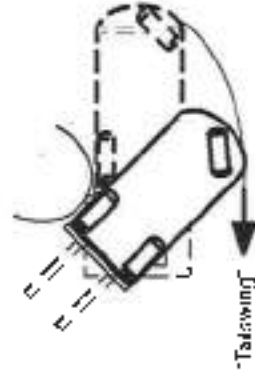

When turning the lift truck from a wide aisle into a narrow aisle, start the turn as close to the opposite stock pile as tailswinging will permit.

This action permits the lift truck to enter the narrow aisle going straight ahead.

LOAD HANDLING - GENERAL

1. Handle only loads within the capacity as shown on the nameplate. This rating represents the maximum load that can be lifted. However, such factors as weak floors, uneven terrain, special load handling attachments or loads having a high center of gravity can mean that the safe working load is less than the rated capacity. When such conditions exist, the operator must reduce the load so that the lift truck will remain stable.



WARNING: Do not handle a load if any loose part of it is above the load backrest or any part of the load is likely to fall.

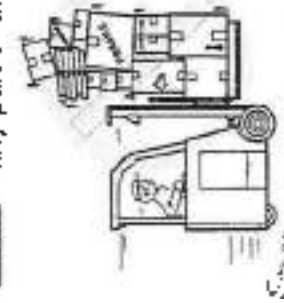

2. Handle only stable loads. A load can have unstable items that can easily shift and fall on someone. Do not handle a load if any loose part of it is above the load backrest, or any part of the load is likely to fall.

3. Position each fork the same distance from the center of the carriage. This action will help center the load on the carriage. Set the forks as far apart as possible for maximum support of the load. Center the weight of the load between the forks.

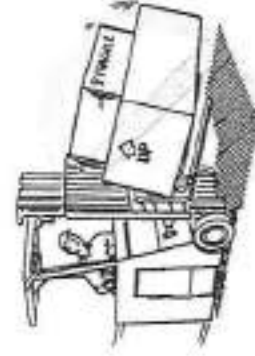

If the weight of the load is not centered between the forks, the load can fall from the forks when you turn a corner or hit a bump. An off-center load will increase the possibility of the truck tipping over to the side. Make sure the pins that keep the forks in position are engaged so that the forks cannot move.

4. Check the condition of the driving surface. Make sure the floor will support the weight of the lift truck and the load.

LIFTING, LOWERING, AND TILTING

See Table 1 for the correct operation of the LIFT and TILT functions

 **WARNING:** Keep yourself and all others clear of the lift mechanism. Never allow anyone under or on the forks.

 **WARNING:** NEVER put hands, arms, head or legs through the mast or near the carriage or lift chains. This warning applies not only to the operator, but also a helper. A helper must not be near the load or lift mechanism while the operator is attempting to handle a load. The lift mechanism has moving parts with close clearances that can cause serious injury.

NOTE: The multi-function handle allows the operator to control travel, lift, tilt, sideshift, horn, and auxiliary

functions. The lift truck can move if the brake pedal is depressed. The multi-function handle can also be moved forward or backward for travel during lifting or lowering operations.



Do not lift or hit anything that can fall on the operator or a bystander. Remember, a lift truck equipped with a YALE overhead guard and load backrest extension provides reasonable protection to the operator from falling objects, but cannot protect against every possible impact. A lift truck without an

overhead guard provides no such protection and other personnel have no overhead protection.

Avoid hitting objects such as stacked material that could become dislodged and fall. The operator must exercise care while working near such objects. Whether the lift truck is loaded or empty do not travel with the load or carriage in a raised position.



Lift and lower with the mast vertical or tilted slightly backward from vertical. Tilt elevated loads forward only when directly over the unloading place. If the lift mechanism is raised to pick up or deposit a load, keep the tilt angle in either direction to a minimum.



Backward and forward tilt are helpful, but they affect side and forward stability. Do not tilt in either direction more than necessary when handling a load that is raised. This lift truck can tip forward if the mast is tilted forward with a load in the raised position.



WARNING: The lift truck can tip over forward when the load is raised. Forward tipping is even more likely when tilting forward, braking when traveling forward or accelerating in reverse.



WARNING: These trucks are designed with open operator compartments to permit easy ingress and egress. Although there is no sure way in all circumstances to avoid injury, where possible, in the event of an imminent tipover or off the dock accident, the operator should **STEP OFF AND AWAY** from the truck. These actions are intended to reduce the risk of serious injury or death.

HOW TO ENGAGE AND DISENGAGE A LOAD

1. Avoid fast starts. Sudden movement can cause the lift truck to tip. People can be hurt or killed and material can be damaged.

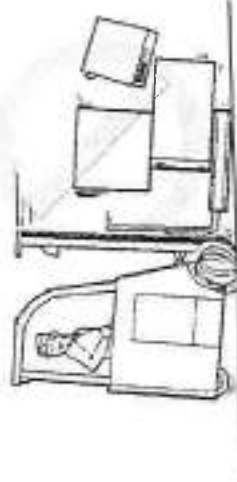

Approach the load carefully. Make sure that the truck is perpendicular to the load. Raise the forks to the proper height for engaging the load.



2. Move forward slowly until the forks are in position under the load. The forks must support at least two-thirds (2/3) of the length of the load. Make sure that the load is centered between the forks.

Make sure that the forks do not extend past the load so that loads or equipment that are behind the load being lifted are not damaged.

If the forks are longer than the load, move the forks under the load so that the tips of the forks do not extend beyond the load. Lift the load from the surface. Move backward a few inches.

Be Careful of Forks Beyond the Load

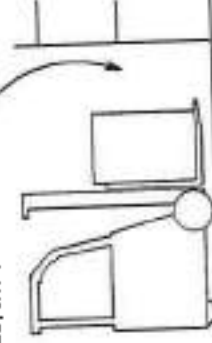

then lower the load onto the surface and "inch" forward to engage the load against the carriage. Tilt the mast backward just far enough to lift the load from the surface.

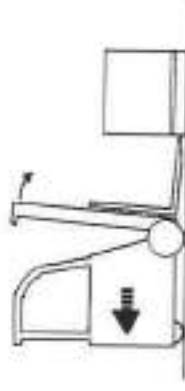

3. When a load is put on the floor, tilt the mast forward to a vertical position and lower the load. Tilt the mast forward to permit smooth removal of the forks. Carefully move the lift truck backward to remove the forks from under the load.

4. If the load is being removed from a stack, slowly move the lift truck away from the stack. When the load is clear of the slack, lower the load for traveling.

Always travel with the load as low as possible and tilted backward. Lowering speed is controlled by the position of the control lever. Lower slowly and smoothly. Slowly return the control lever to the neutral position so that the load is not dropped or that the lift truck is not tipped over due to the rapid stop of the load

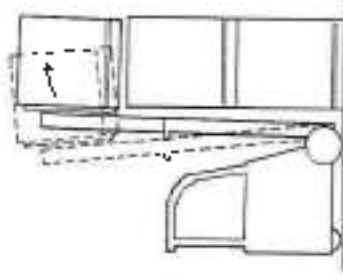
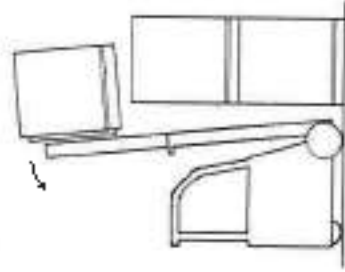

5. To put the load on a stack, align the lift truck with the stack. Raise the load higher than the point where it will be placed. Tilt the load forward until the mast is vertical or tilted slightly back. Do not raise the load to a point below where the load is to be placed and 'jog' the load up into position. This operation

uses additional energy, particularly with an electric lift truck. Be careful not to damage or move adjacent loads.

WARNING: Move carefully and smoothly when the load is raised over a stack. When the load is elevated, the center of gravity of the lift truck and the load is much higher. The lift truck can tip over when the load is raised.

WARNING: These trucks are designed with open operator compartments to permit easy ingress and egress. Although there is no sure way in all circumstances to avoid injury, where possible, in the event of an imminent tipover or off the dock accident, the operator should **STEP OFF AND AWAY** from the truck. These actions are intended to reduce the risk of serious injury or death.

Move forward slowly. When the load is in position, lower the load on to the stack or the rack. Tilt the forks forward just enough to remove them from under the load. Do not lower the forks so that they will drag on the surface under the load. Carefully move the lift truck backward to remove the forks from under the load. Lower the forks when traveling

NOTE: Not every load can be lifted using only the forks of a lift truck. Some loads will require a special attachment.

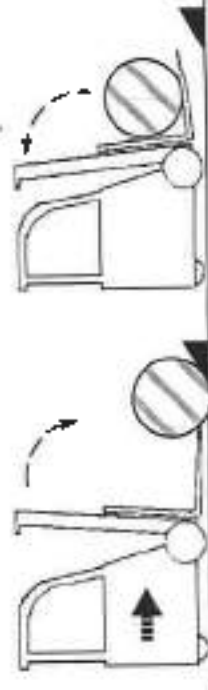

6. When lifting round objects, use a block behind the object. Tilt the mast forward so that the forks can slide along the floor under the object to be lifted. Tilt the mast fully backward to help keep the load on the forks.

TRAVELING

1. When traveling with the load lowered, keep the load against the carriage and the mast tilted fully backward. This action will help keep the load on the forks and give good forward and side stability.

2. Travel with the fill mechanism raised only enough to clear the ground or obstacles. When any part of the mast is raised, with or without a load, the stability of the lift truck is reduced.

The ability of the lift truck to resist side tipping can be less for a lift truck that is not carrying a load than it is for a lift truck that is carrying a load in the lowered (travel) position.

Therefore, a lift truck without a load is more likely to tip sideways, especially in a turn, than a lift truck with a load, provided the load is carried in the lowered position.

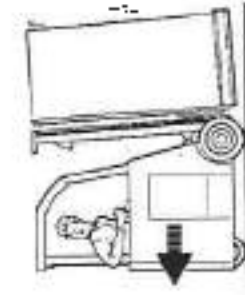
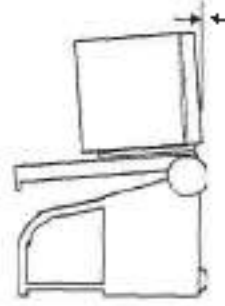

3. For better visibility with large loads, travel with the load trailing, but always keep a proper lookout in the direction of travel. Normally, direction of travel is determined by the best visibility available to the operator. If the lift truck must travel in a direction where visibility is obstructed, a trained lookout helper is required.

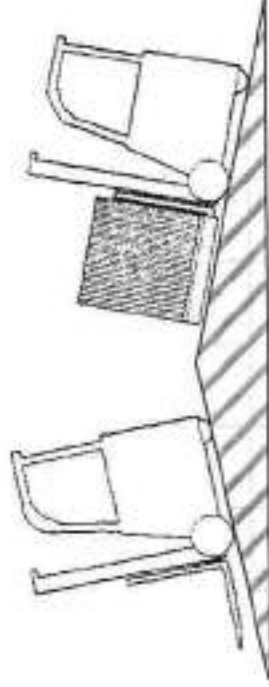

OPERATING PROCEDURES

HYSTER

4. When traveling up or down a grade with a **heavily loaded** lift truck, keep the load upgrade to maintain control. When operating an **unloaded** lift truck on a steep grade, keep the battery and counterweight upgrade.



5. Watch out for pedestrians at all times. Do not drive up close to anyone standing in front of an object. Use extra care at cross aisles, doorways and other locations where pedestrians can step into the path of travel of the lift truck. Slow down when approaching blind intersections or turns. Sound the horn to warn pedestrians that there is a vehicle in the area and to be alert to possible danger.

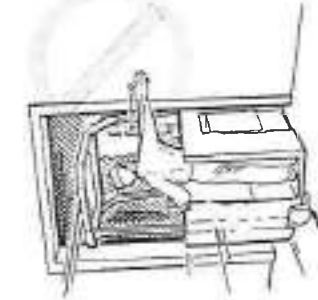

6. Anytime the lift truck is moving keep arms, legs, etc. inside the operator's compartment. Arms and legs outside the machine can be injured when passing instructions

7. Avoid bumps, holes, slick spots and loose materials that may cause the lift truck to swerve or tip. If hazards are unavoidable, slow down.

Solid rubber tire models are designed to operate on relatively smooth, firm surfaces. Lift trucks with pneumatic tires can adapt to more uneven ground. Always make sure you pick the smoothest route for your lift truck.

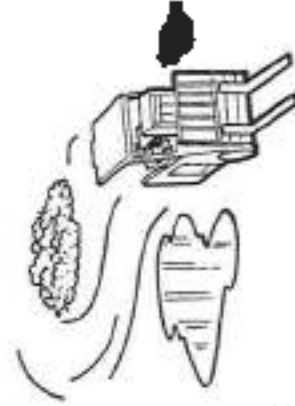

8. Watch clearances, especially forks mast, overhead guard and tailswing. A lift truck is designed to perform a wide variety of functions within limited space. The operator must be aware that the forks can sometimes extend beyond the front of the load. If the forks extend beyond the load, the operator can hit an object or lift another load.

the front of the load. If the forks extend beyond the load, the operator can hit an object or lift another load.



WARNING: Serious accidents can be caused by the mast or overhead guard hitting pipes and beams near the ceiling.

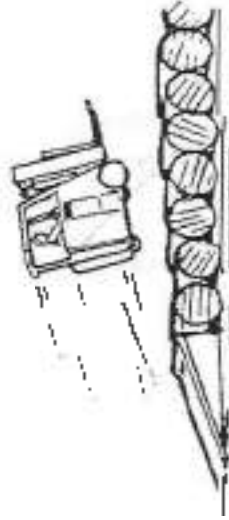

9. Do not indulge in stunt driving or horseplay.



WARNING: These trucks are designed with open operator compartments to permit easy ingress and egress. Although there is no egress way in all circumstances to avoid injury, where possible, in the event of an imminent lipover or off the dock accident, the operator should **STEP OFF AND AWAY** from the truck. These actions are intended to reduce the risk of serious injury or death.

10. Stay away from the edge of the road. Keep the wheels of the lift truck, particularly the steer wheels, on the roadway. If the wheels are allowed to run off the edge of the travel surface onto soft ground, the lift truck can tip over



11. Do not pass another lift truck traveling in the same direction at intersections, blind spots or at other dangerous locations.

12. Under all travel conditions, operate the lift truck at a speed that will permit it to be brought to a stop in a safe manner.



HIGHWAY TRUCKS, RAILROAD CARS, AND DOCKS

 **WARNING:** These trucks are designed with open operator compartments to permit easy ingress and egress. Although there is no sure way in all circumstances to avoid injury, where possible, in the event of an imminent tipover or off the dock accident, the operator should **STEP OFF AND AWAY** from the truck. These actions are intended to reduce the risk of serious injury or death.

Make sure the dock lcad is secured, in good condition and of the proper capacity.

Before operating in a highway truck or railroad car check the condition of the driving surface. Make sure the floor will support the weight of the lift truck and the load.

DO NOT use a lift truck to move a railroad car. **DO NOT** use a lift truck to open or close the door on a railroad car unless the lift truck has an attachment that is specifically designed for opening and closing rail car doors and the operator is trained in its use.

Check to make sure that the brakes on the highway truck are set and that wheel blocks have been placed on both sides of the rear wheels (unless a dock locking mechanism is engaged). Fixed jacks may be necessary to support the front and rear of a semi-trailer to prevent it from moving or tipping during loading or unloading.

Make sure that the railroad car brakes are set and the wheels are blocked while loading or unloading. Do this so that the railroad car will not move due to the movement of the lift truck in and out of the railroad car.

When entering a railroad car the operator can enter at an angle (if the dock plate or bridge is wide enough). This will reduce the turning required after entering.

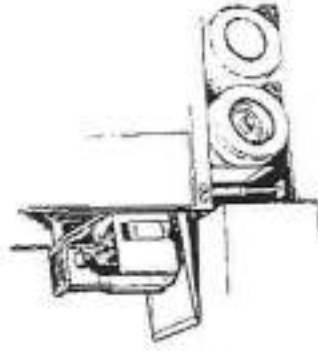

ATTACHMENTS

If an attachment is installed on the lift truck, make sure the operating instructions are available and understood before operating the attachment.



WARNING: Make sure the nameplate is correct if an attachment has been installed.

STOPPING

Stop the lift truck as gradually as possible. Hard braking

and wheel sliding can cause the load to fall off of the forks and damage the load or hurt someone.

PARKING

The operator must never leave a lift truck in a condition so that it can cause damage and injury. When parking the lift truck, do the following operations:

1. Release the multi-function handle to the **NEUTRAL** position.
2. Release the brake pedal to apply the brake.
3. Fully lower the forks or carriage. Tilt mast forward until the tips of the forks touch the ground.
4. Turn the key switch to the "0" (OFF) position and remove the key. (If the lift truck is parked because of a malfunction, also disconnect the battery.)
5. Disconnect the battery when leaving the lift truck.
6. If the lift truck must be left on an incline, put blocks on the down hill side of the wheels so that the lift truck cannot move.

Do not park the lift truck so that it limits access to fire aisles, stairways, and fire equipment.

MAINTENANCE

GENERAL

This section contains a **MAINTENANCE SCHEDULE** and the instructions for daily (8-hour) maintenance and inspection. See the **PERIODIC MAINTENANCE** section for instructions for other maintenance intervals.

MAINTENANCE SCHEDULE

The **MAINTENANCE SCHEDULE (TABLE 1)** has time intervals for inspection, lubrication, and maintenance. The time intervals are based on a normal operation. A normal operation is considered to be one 8-hour shift per day in a relatively clean environment on an improved surface. Refer to **FIGURE 5** for maintenance points. Multiple shifts, dirty operating conditions, etc., will require a reduction in the recommended time periods in the **MAINTENANCE SCHEDULE**.

Your **HYSTER** lift truck dealer has the facilities and trained personnel to do the maintenance. A complete program of inspection, lubrication, and maintenance will help your lift truck perform efficiently and operate over a longer period of time.

Some users have service personnel and facilities to do the items listed in the **MAINTENANCE SCHEDULE. SERVICE MANUALS** are available from your **HYSTER** lift truck dealer to help users who do their own maintenance.



WARNING: Do not operate a lift truck that needs repairs. Report the need for repairs immediately. If repair is necessary, put a "DO NOT OPERATE" tag in the operator's area. Remove the key from the key switch. Disconnect battery connector. Do not make repairs or adjustments unless you have both authorization and training. Repairs and adjustments that are not correct can make a dangerous operating condition.

Do not work under a raised carriage. Lower the carriage or use a chain to prevent the carriage and the inner or intermediate weldments from lowering when doing maintenance. Make sure that moving parts are attached to parts that cannot move.

TABLE 1. MAINTENANCE SCHEDULE

ITEM NO.	ITEM	8 hr or 1 day*	350 hr or 2 months†	2000 hr or 1 year‡	PROCD. INT. CR QUANTITY	SPECIFICATION
1	Battery Battery Connector Battery Disconnect † Battery Gasket Battery Holders † Brakes	X X X X	5		Check Level Check Connection Check Operation Check Condition Clean as Required Check Operation	Set Specifications Disconnect Bolt Installed Lever Moves Freely and Connects Separately Secure and in Place
2	Brake Pads Brake Pedals Brake Switch	X X X		X	Check Operation Check Condition Check Operation Check Operation	No Binding Travel Disabled if Pedal Up
3	Directional/Speed/Clutch Control †	X			Check Operation	No Entering Proper Operation
4	Electrical Circuits Complainers Motor Brushes	X	X X		Check Operation Check Condition Check Condition	
5	Forks/Carrages/Load Backrest Fork Guides and Locks Sideshift Carriage	X X X	1 1		Check for Damage Lubricate as Required	§ E
6	Gearbox Fluid Level	X	7	C	Check Operation Full Mark	SAE-80W-90 Gear Lube or Equivalent
7	Hydraulic Oil Leaks Hydraulic Oil Level Breather Cap Hydraulic Oil Filter Hydraulic Tank Filler Neck Strainer	X X	7 X 7 7	C R C R	Check for Leaks Middle Mark Clean or Replace Replace Clean or Replace	Annua 0°C (32°F) Below 0°C † See Parts Manual See Parts Manual See Parts Manual

TABLE 1. MAINTENANCE SCHEDULE

6	LH Chains and Chain Anchors	X	L	11	Check for Damage Center Pins in Place	Above 0° C (32° F) ¹⁰ Below 0° C ⁹
8	Mast Pivots: Sliding Surfaces Channels, Load Rollers Center Pin at Tilt Cylinder Pins Tilt Cylinder Pins Mast Turnover Bearings	X X X X	L L L L L ⁹		Check Operation Lubricate as Required Center Pins in Place Lubricate 4 Filings Lubricate 2 Filings	Above 3° C (32° F) ¹⁰ Below 0° C ⁹ Place blocks under outer upright channels and tilt upright forward to take the load off top of wear rings before greasing.
10	Multi-Function Control Handle Switches - Horn, Tilt and Aux. O	X			Check Operation	No Binding/Proper Operation
11	Operator's Display, Horn, Lights, Fuses	X			Check Operation	
12	Safety Labels & Operating Manual	X			Replace if Necessary	See Parts Manual
13	Steering Operation	X			Check Operation	No Binding/Proper Operation
14	Tire & Wheels - Drive & Steer	X			Check Condition	
15	Transaxle Outer Pinion Bearing			6 L L	Lubricate ? Filings	Remove the Drive Tires to access the grease fittings. Lube each fitting until grease exits the relief hole. Remove excess grease from failed hole w/c.a.
16	Station Signal	X			Check for Damage	Replace if Damaged or Missing
17	Manual Safety Disconnected Lever	X			Check Operation Lubricate as Required	3

X = Check C = Change L = Lubricate R = Replace

- 1 HYSTER Part Number 2046457
- 2 HYSTER Part Number 2046458
- 3 HYSTER Part Number 2046459
- 4 Which ever comes first
- 5 Equalization Charge approximately each month but not more than each week
- 6 Multi-Purpose Grease with 2-4% Molybdenum Disulfide for normal operations

- 7 Change fluid and filter on new trucks at first 350 hours
- 8 Do Not Lubricate
- 9 Low Temperature Grease
- 10 SAE 80W Motor Oil
- 11 At 2000 hours, remove, clean, and lubricate per Service Manual.

NOTE: Never use steam to clear electrical parts.

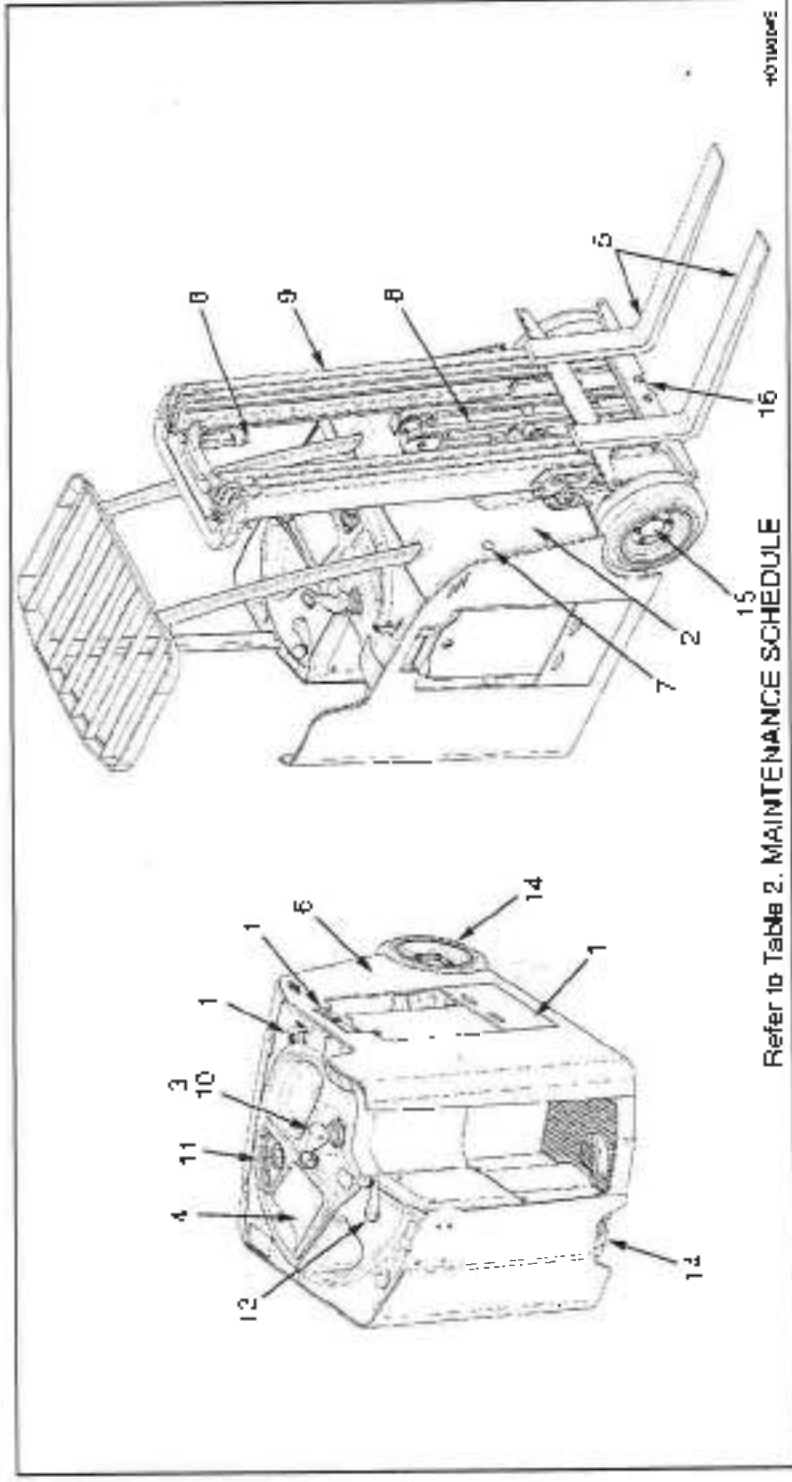



CAUTION: Disposal of lubricants and fluids must meet local environmental regulations.

Maintenance, service and repair must be performed by trained personnel.

Put the lift truck on a level surface. Lower the carriage and forks and turn the key switch to the "O" (OFF) position. Disconnect the battery. Open the access panels and check for leaks and conditions that are not normal. Clean any oil or other spills. Make sure that lint, dust, paper, and other materials are removed from the compartments.

HOW TO MOVE A DISABLED LIFT TRUCK



WARNING: Use extra care when towing a lift truck if there is a problem with any of the following:

1. Brakes do not operate correctly.
2. Steering does not operate properly.
3. Tires are damaged.
4. Traction conditions are bad.
5. The lift truck must be moved on a steep grade.

If the steering pump motor does not operate, steering control of the lift truck can be slow. This can make the control of the lift truck difficult. If there is no electrical power, there is no power steering. DO NOT tow the lift truck if there is no power. Poor traction can cause the disabled lift truck or towing vehicle to slide. Steep grades will require additional brake force to stop the lift truck.

If the lift truck must be moved without power, the brakes can be manually released. There are two holes with 1/4-20UNC threads in the armature plate of each brake. Install two 1-1/4 inch long "Maintenance Capscrews" in the holes and tighten them until the air gap between the magnet body and the armature disappears. This will pull the armature away from the friction disc and allow the motor to turn freely. Be sure to remove the screws when finished towing.

Never carry a disabled lift truck unless the lift truck MUST be moved and cannot be towed. The lift truck used to carry the disabled lift truck MUST have a rated capacity equal to or greater than the weight of the disabled lift truck. The capacity must be for a load center equal to half the width of the disabled lift truck.

See the nameplate of the disabled lift truck for the approximate total weight. The forks must extend the full